



US00D684724S

(12) **United States Design Patent**
Tokui et al.

(10) **Patent No.:** **US D684,724 S**
(45) **Date of Patent:** **** Jun. 18, 2013**

(54) **DENTAL FLOSSING TOOL**
(75) Inventors: **Kaori Tokui**, Tokyo (JP); **Kumiko Yokonuma**, Tokyo (JP)
(73) Assignee: **GC Corporation**, Tokyo (JP)
(**) Term: **14 Years**
(21) Appl. No.: **29/392,206**
(22) Filed: **May 18, 2011**

(30) **Foreign Application Priority Data**
Nov. 22, 2010 (JP) 2010-027950
(51) **LOC (9) Cl.** **28-03**
(52) **U.S. Cl.**
USPC **D28/66**
(58) **Field of Classification Search**
USPC ... D28/31, 56, 65-68, 73; D24/152; 433/141,
433/146-147; 132/322-329
See application file for complete search history.

(56) **References Cited**
U.S. PATENT DOCUMENTS
3,892,249 A * 7/1975 Jones et al. 132/323
7,059,334 B2 * 6/2006 Dougan et al. 132/323
7,171,971 B2 * 2/2007 Ochs et al. 132/323
7,204,257 B2 * 4/2007 Crossman 132/323
7,325,554 B2 * 2/2008 Ochs 132/323

7,370,658 B2 * 5/2008 Chodorow et al. 132/323
7,487,785 B2 * 2/2009 Dougan et al. 132/323
7,647,934 B2 * 1/2010 Yim 132/323
2005/0172982 A1 * 8/2005 Ochs et al. 132/323

* cited by examiner

Primary Examiner — Zenia Bennett
(74) *Attorney, Agent, or Firm* — Oblon, Spivak, McClelland, Maier & Neustadt, L.L.P.

(57) **CLAIM**
The ornamental design for a dental flossing tool, as shown and described.

DESCRIPTION

FIG. 1 is a front view of a dental flossing tool showing our new design;
FIG. 2 is a rear view thereof;
FIG. 3 is a right side view thereof;
FIG. 4 is a left side view thereof;
FIG. 5 is a plan view thereof;
FIG. 6 is a bottom view thereof;
FIG. 7 is a perspective view thereof;
FIG. 8 is a reference perspective view showing a state that the dental floss holder is rotated thereof;
FIG. 9 is a reference view showing a state that the dental floss holder is removed thereof; and,
FIG. 10 is an enlarged reference view showing a state that the dental floss holder is removed thereof.

1 Claim, 9 Drawing Sheets

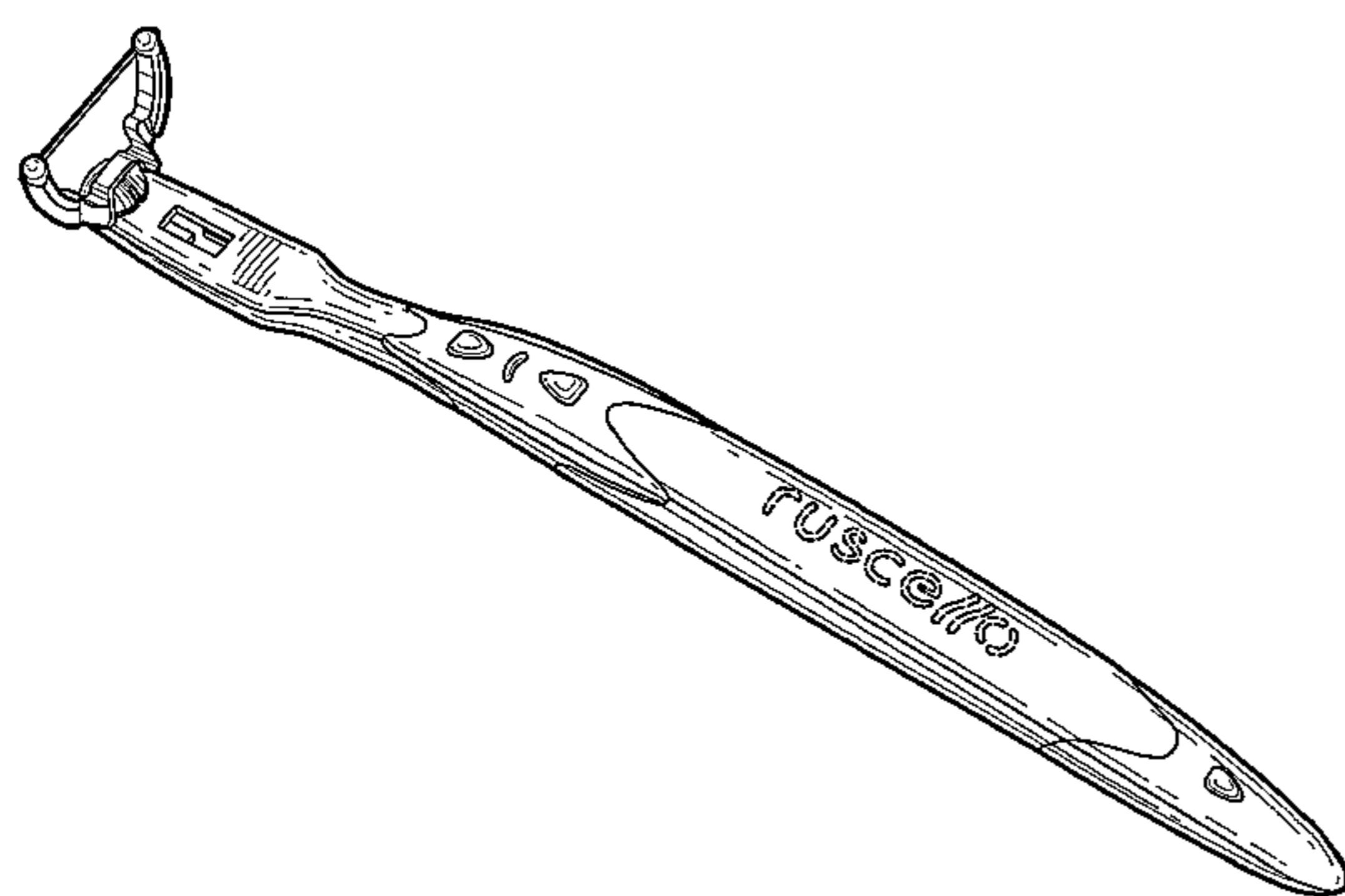

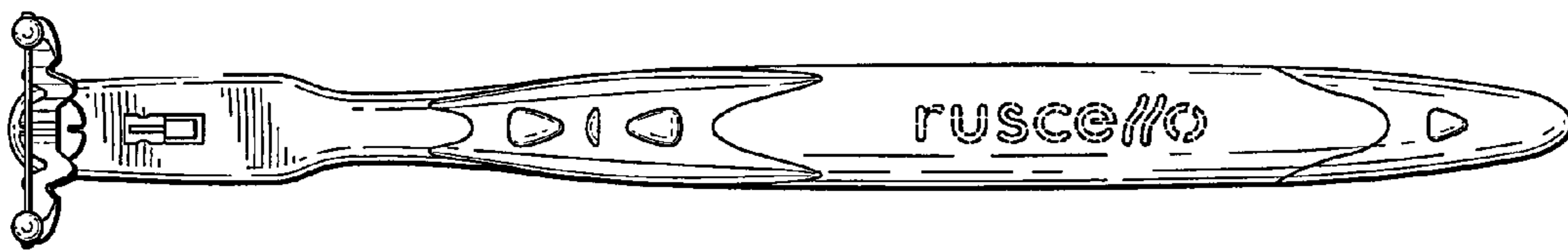

Fig. 1

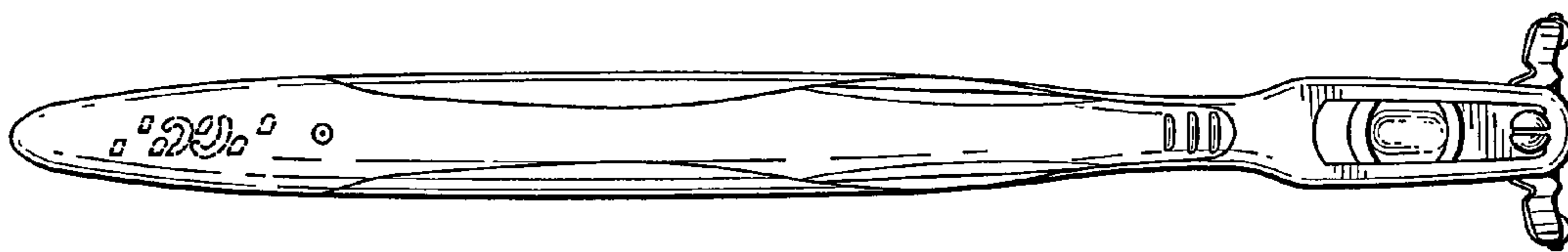

Fig. 2

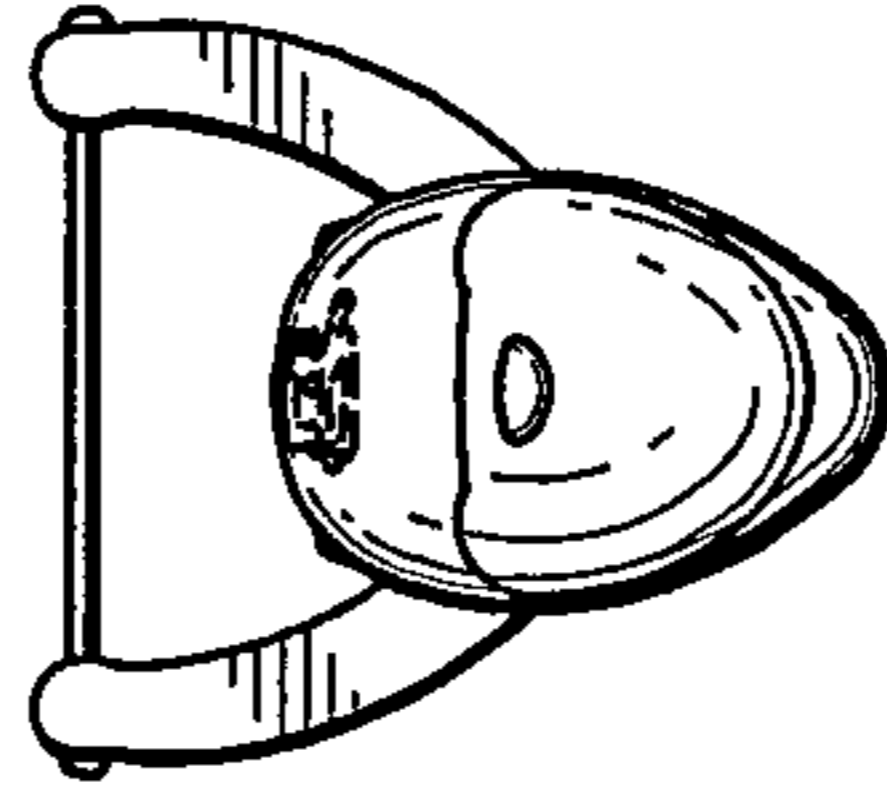

Fig. 3

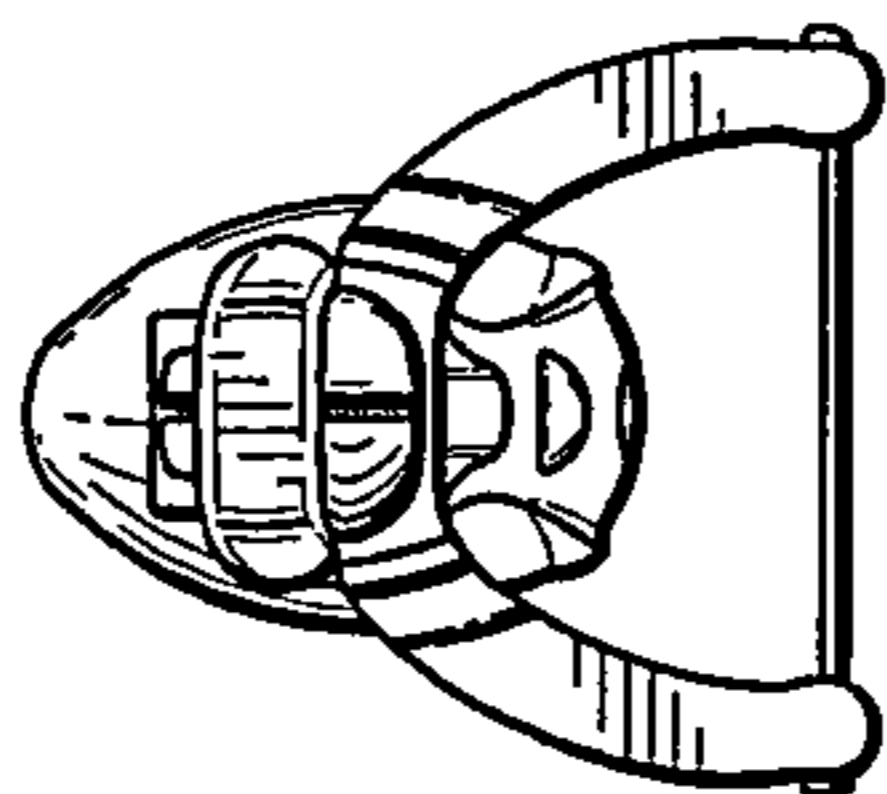

Fig. 4

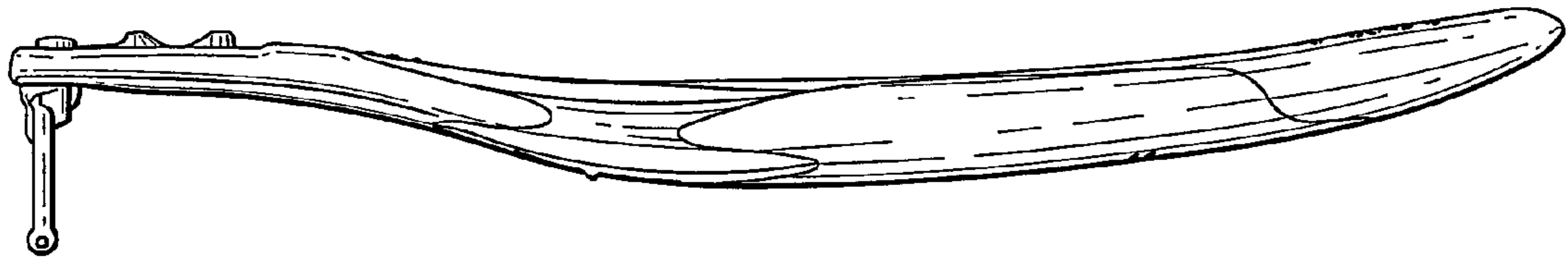

Fig. 5

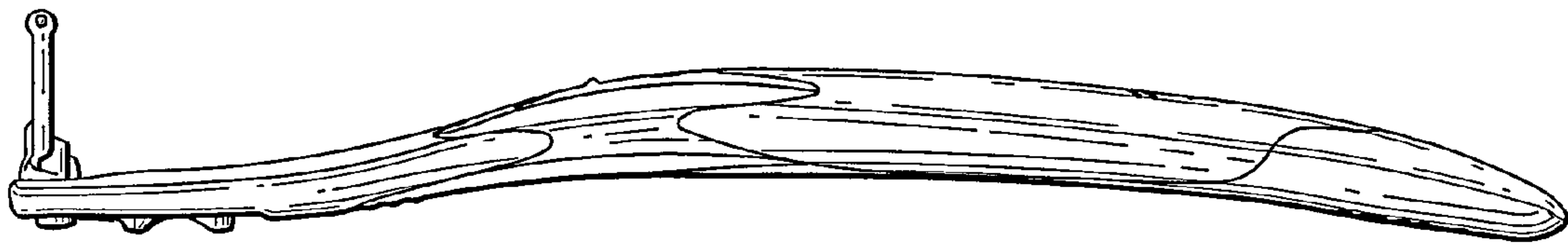

Fig. 6

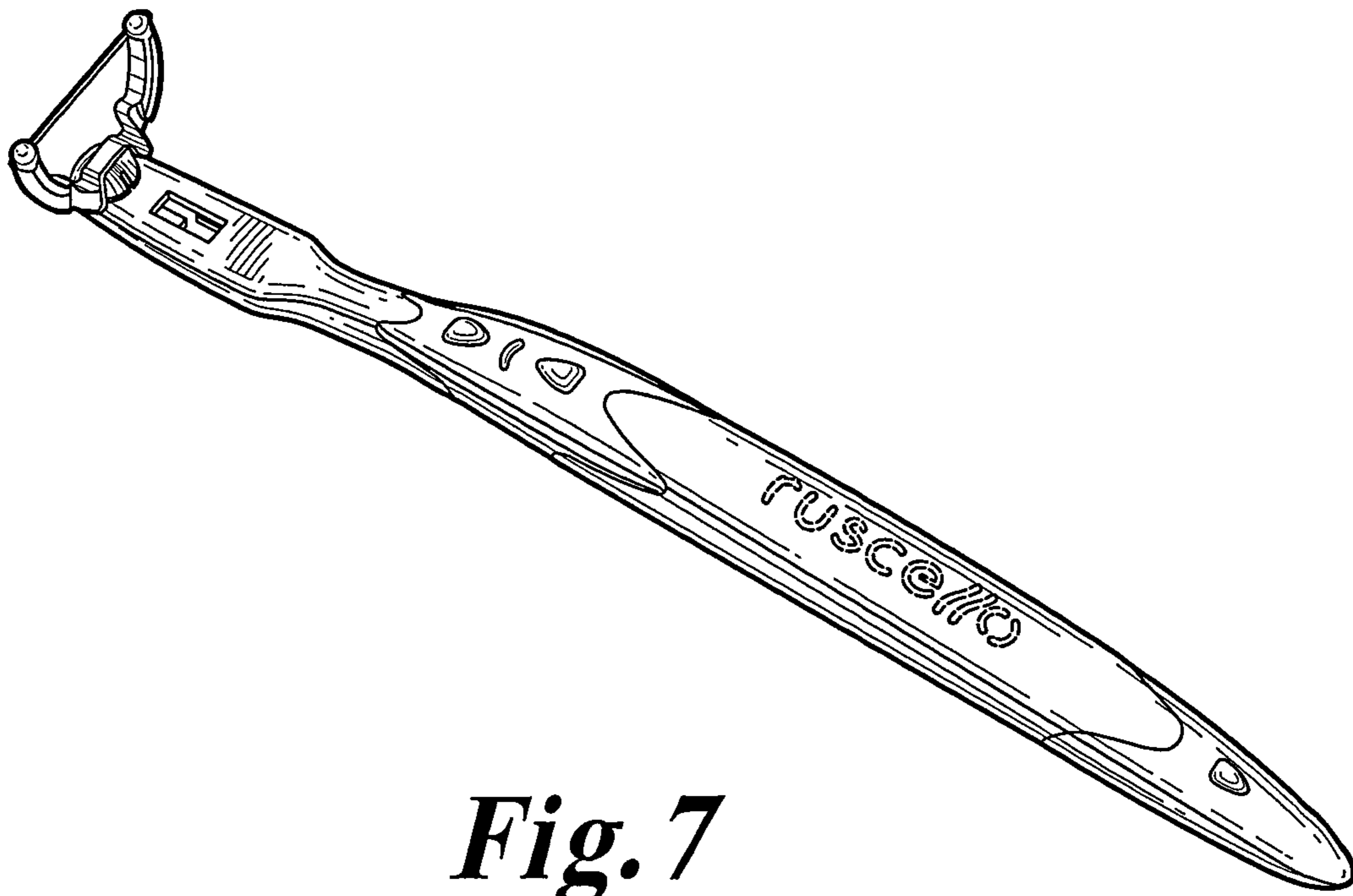

Fig. 7

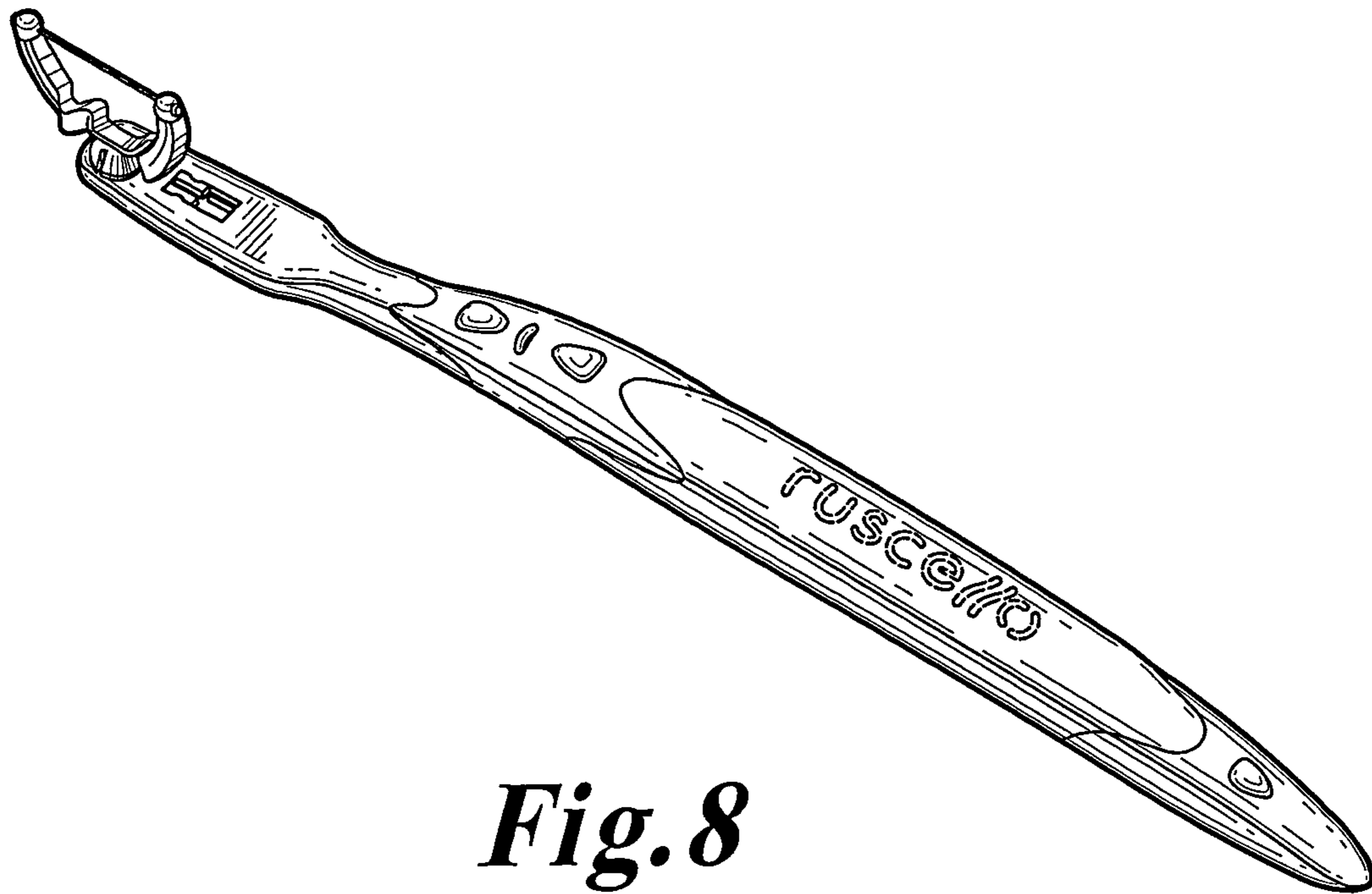

Fig. 8

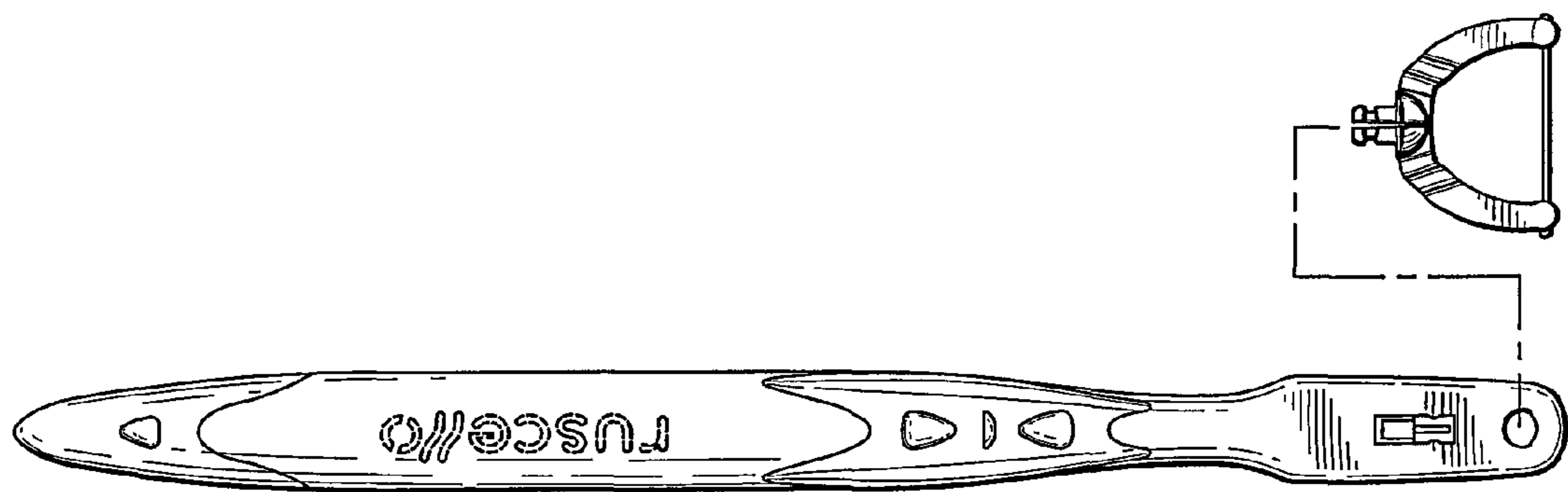

Fig. 9

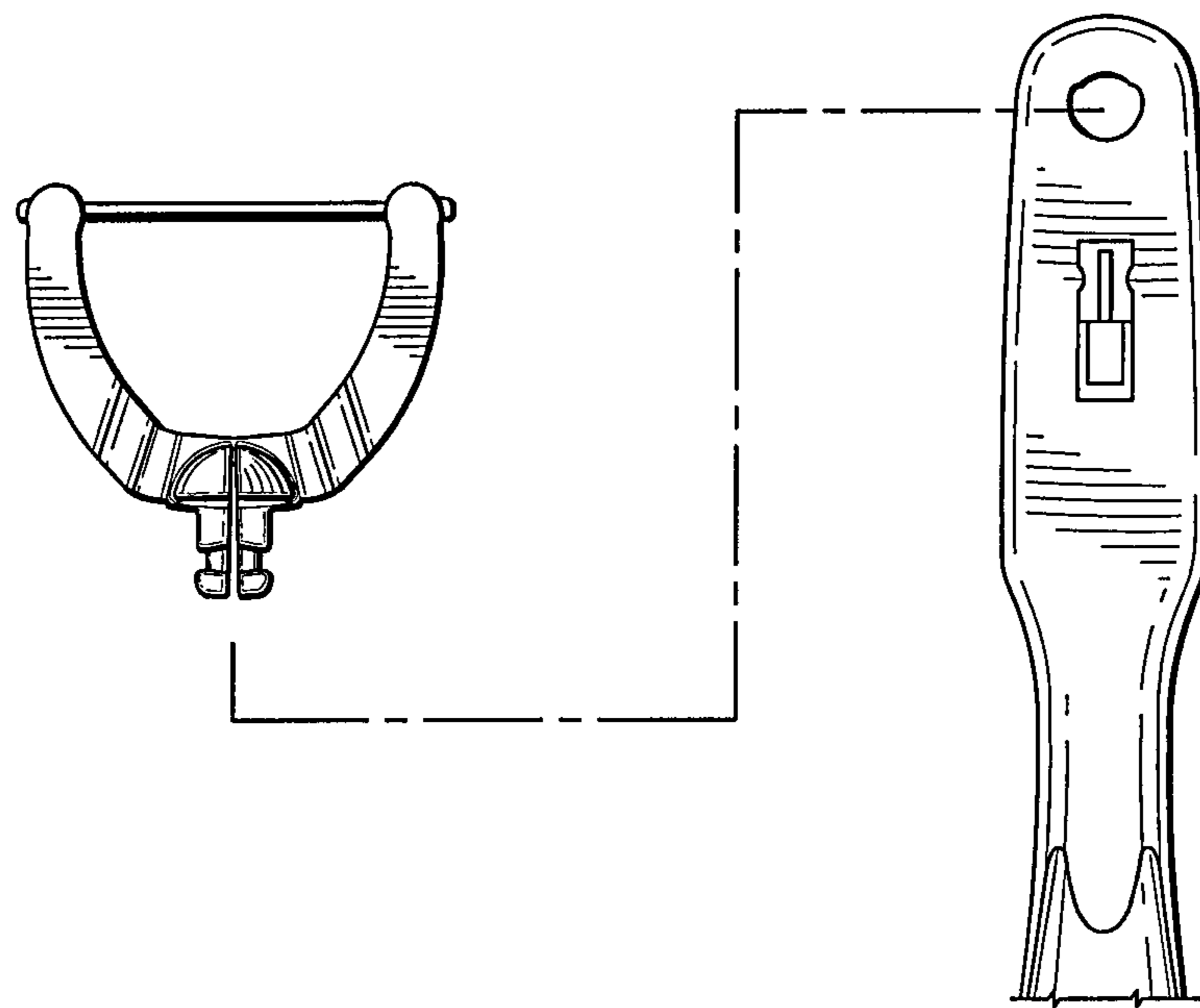

Fig. 10