



US00D684695S

(12) **United States Design Patent**
Green et al.

(10) **Patent No.:** **US D684,695 S**
(45) **Date of Patent:** **** Jun. 18, 2013**

(54) **NON-PNEUMATIC TOURNIQUET DEVICE**

(75) Inventors: **William J. Green**, Thousand Oaks, CA (US); **Ted J. Brackett**, Manhattan Beach, CA (US)

(73) Assignee: **Precision Medical Devices, LLC**, Thousand Oaks, CA (US)

(**) Term: **14 Years**

(21) Appl. No.: **29/419,193**

(22) Filed: **Apr. 26, 2012**

Related U.S. Application Data

(63) Continuation of application No. 29/405,373, filed on Nov. 1, 2011, now abandoned, which is a continuation-in-part of application No. 12/114,737, filed on May 2, 2008, and a continuation-in-part of application No. 12/897,770, filed on Oct. 4, 2010.

(51) **LOC (9) Cl.** **24-01**

(52) **U.S. Cl.**
USPC **D24/169**; D24/143

(58) **Field of Classification Search**
USPC D24/107, 143, 164–169, 188–190,
D24/192; 600/490; 601/149, 151–152;
606/202–203

See application file for complete search history.

(56) **References Cited**

U.S. PATENT DOCUMENTS

D272,186 S * 1/1984 Peck D24/143
4,637,394 A * 1/1987 Racz et al. 606/202

(Continued)

Primary Examiner — Wan Laymon

(74) *Attorney, Agent, or Firm* — Law Office of David Hong

(57) **CLAIM**

The ornamental design for a non-pneumatic tourniquet device, as shown and described.

DESCRIPTION

This application is also related to PCT/US08/62583, filed on May 2, 2008;

U.S. Design patent application Ser. No. 29/317,784, filed on May 6, 2008, and now U.S. Design Pat. No. D625,824;

U.S. Design patent application Ser. No. 29/346,791, filed on Nov. 5, 2009, and now U.S. Design Pat. No. D642,275; and

U.S. Design patent application Ser. No. 29/419,189, filed on Apr. 25, 2012.

FIG. 1 is a perspective view of a non-pneumatic tourniquet device showing our new design;

FIG. 2 is a top view thereof, the bottom view being a mirror image;

FIG. 3 is a first side elevational view thereof; the opposite side view being a mirror image;

FIG. 4 is a third side elevational view thereof;

FIG. 5 is a fourth side elevational view thereof;

FIG. 6 is a cross-sectional view thereof, taken along line 6-6 in FIG. 2.

FIG. 7 is a perspective view thereof, with the central element seen in FIG. 1 through FIG. 6 removed in order to depict the inner structure of the non-pneumatic tourniquet device;

FIG. 8 is a top view of the non-pneumatic tourniquet device of FIG. 7, the bottom view being a mirror image;

FIG. 9 is a first side view of the non-pneumatic tourniquet device of FIG. 7; the opposite side view being a mirror image;

FIG. 10 is a third side view of the non-pneumatic tourniquet device of FIG. 7;

FIG. 11 is a fourth side view of the non-pneumatic tourniquet device of FIG. 7; and,

FIG. 12 is a cross-sectional view of the non-pneumatic tourniquet device of FIG. 7, taken along line 12-12 of FIG. 8.

The broken lines represent portions of the structure that form no part of the claim.

1 Claim, 2 Drawing Sheets

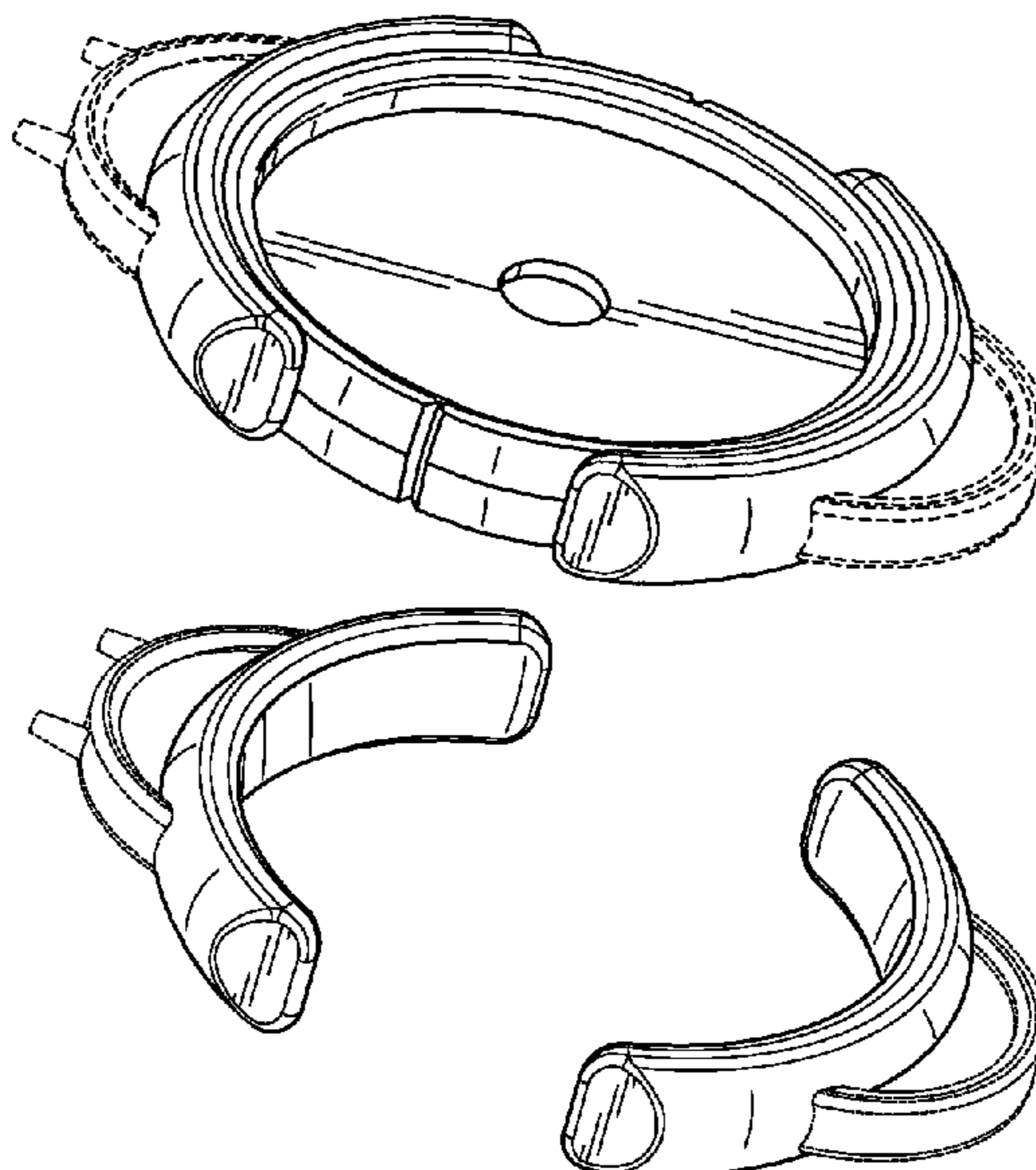

US D684,695 S

Page 2

U.S. PATENT DOCUMENTS							
				D642,275 S *	7/2011	Brackett et al.	D24/169
4,911,162 A *	3/1990	Wolff	606/203	2006/0089668 A1 *	4/2006	Warburton	606/203
5,304,202 A *	4/1994	Stahl	606/203	2008/0275499 A1 *	11/2008	Brackett et al.	606/203
5,607,448 A *	3/1997	Stahl et al.	606/203	2011/0022077 A1 *	1/2011	Green et al.	606/203
D625,824 S *	10/2010	Brackett et al.	D24/188				

* cited by examiner

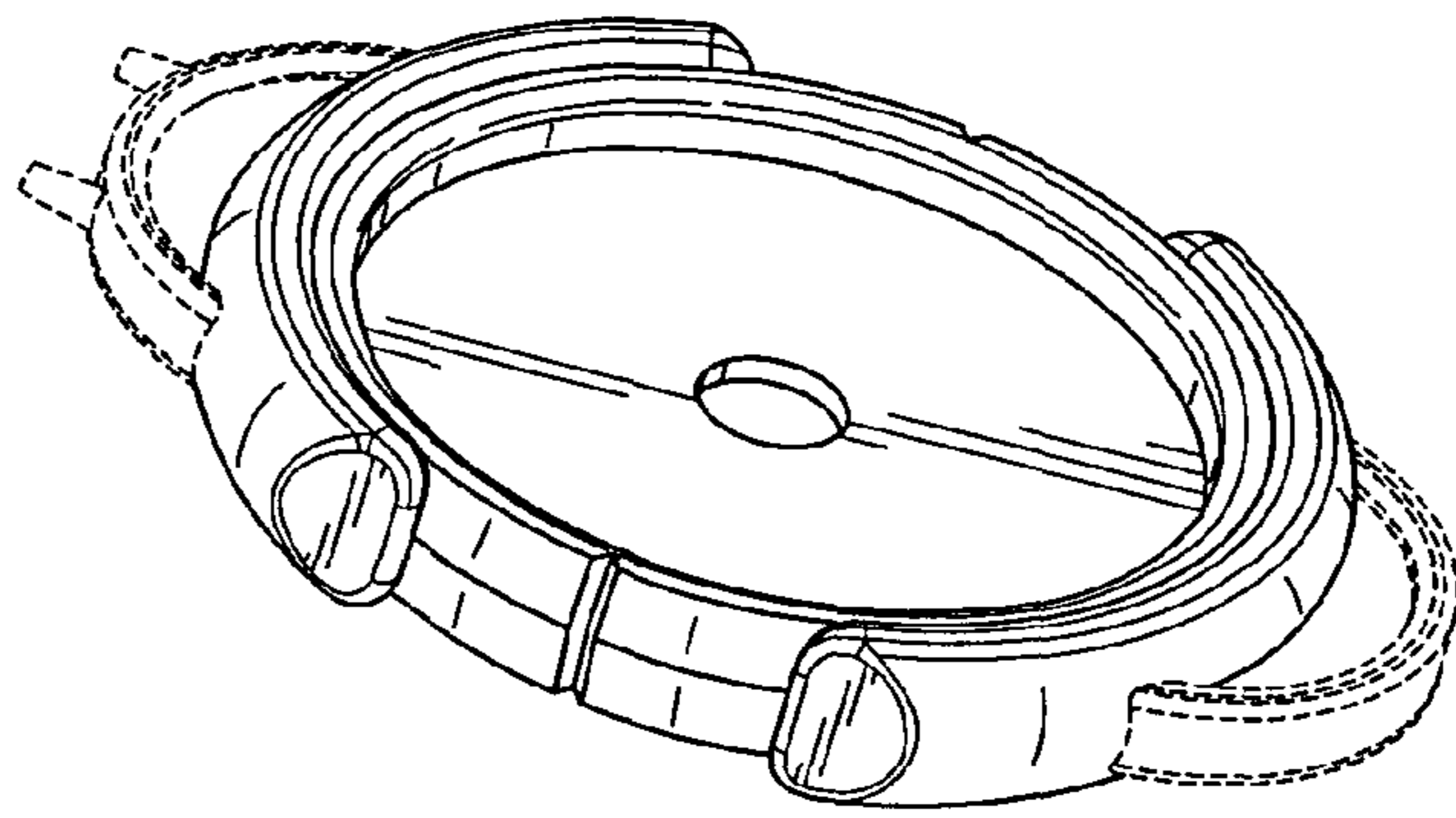

FIG. 1

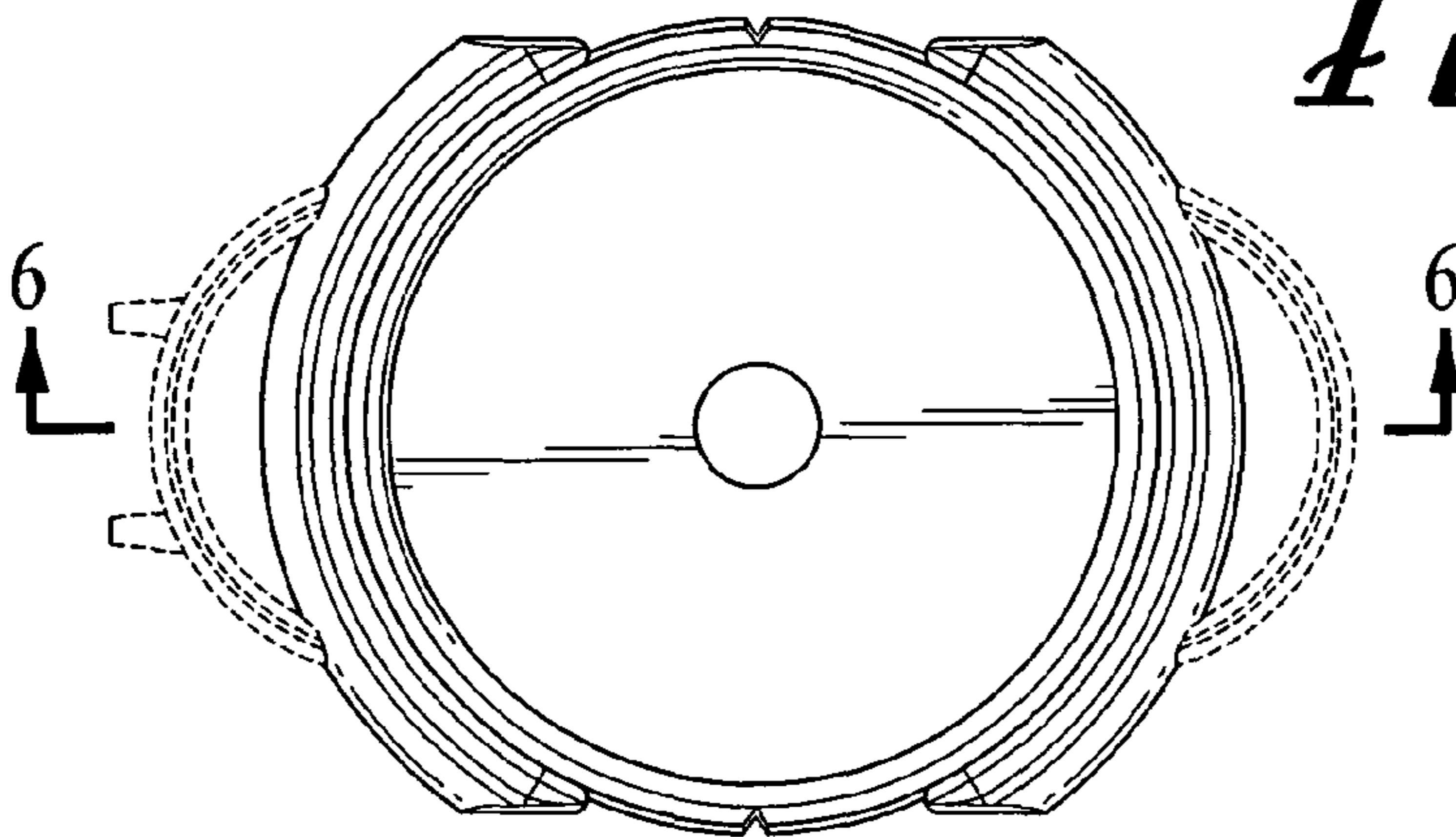

FIG. 2

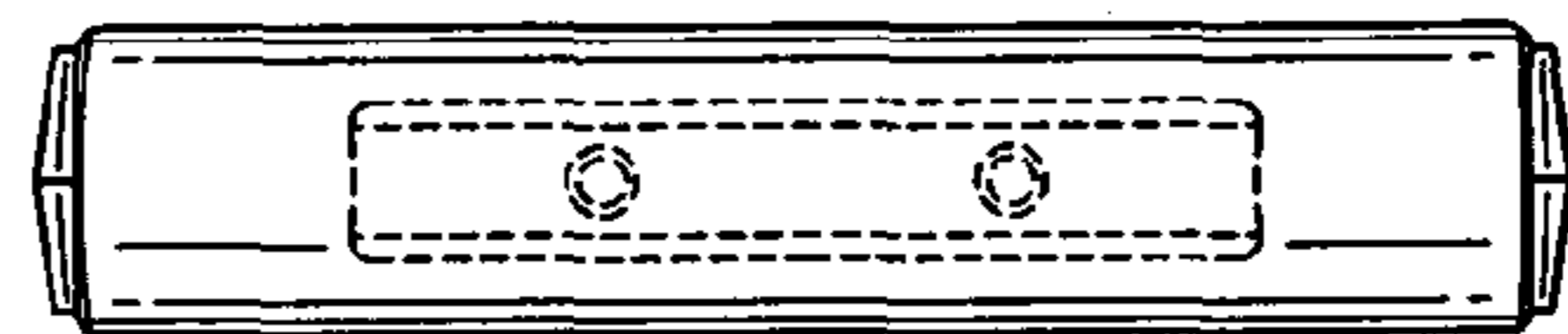

FIG. 4

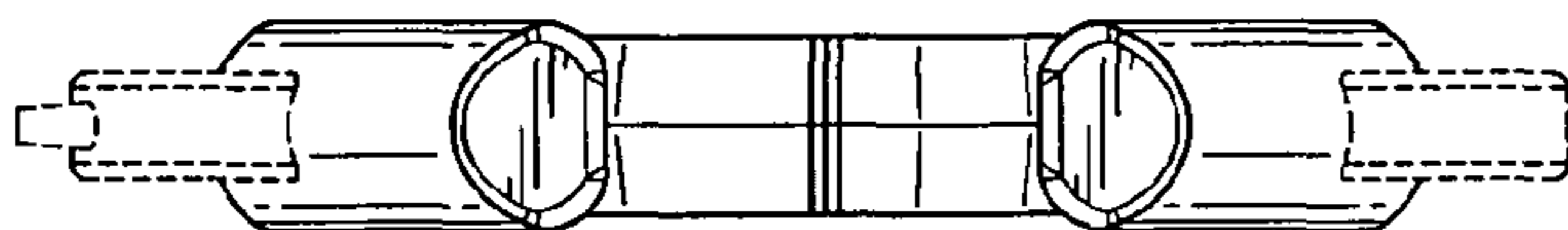

FIG. 3

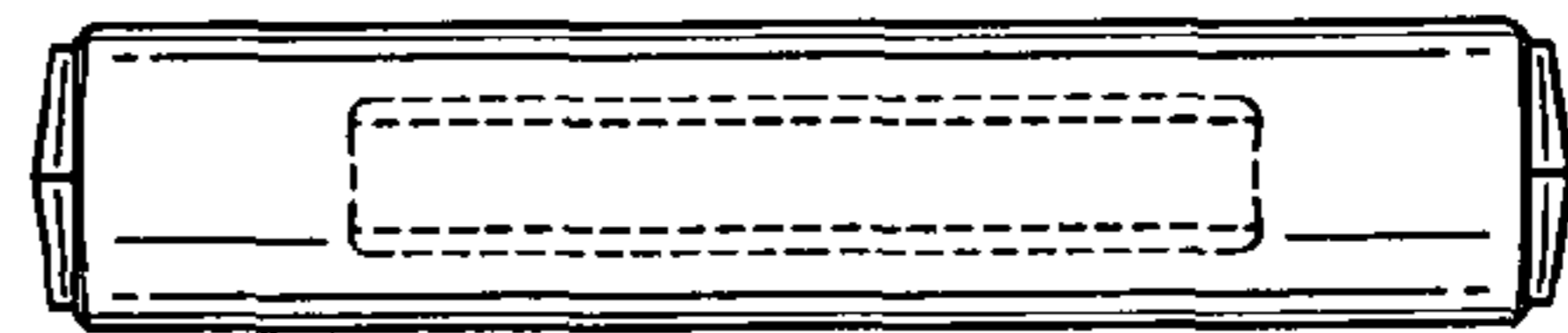

FIG. 5

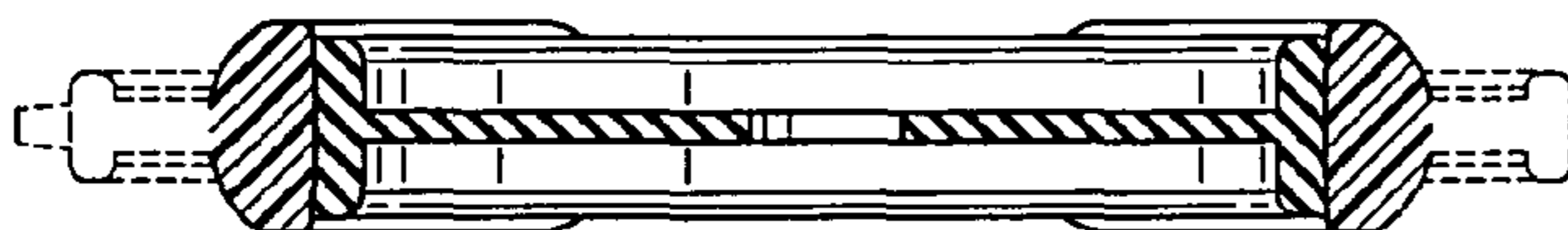

FIG. 6

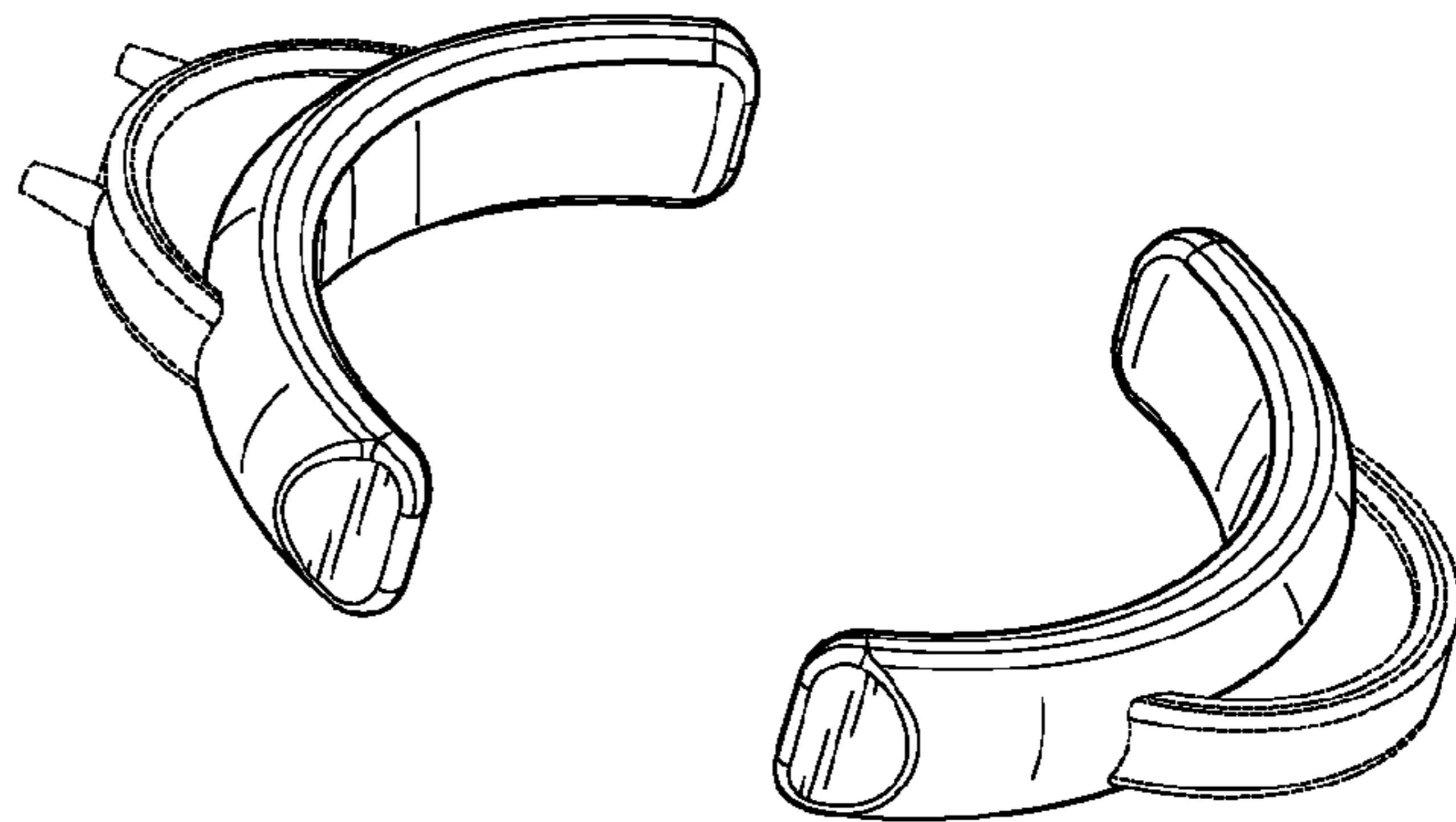

Fig. 7

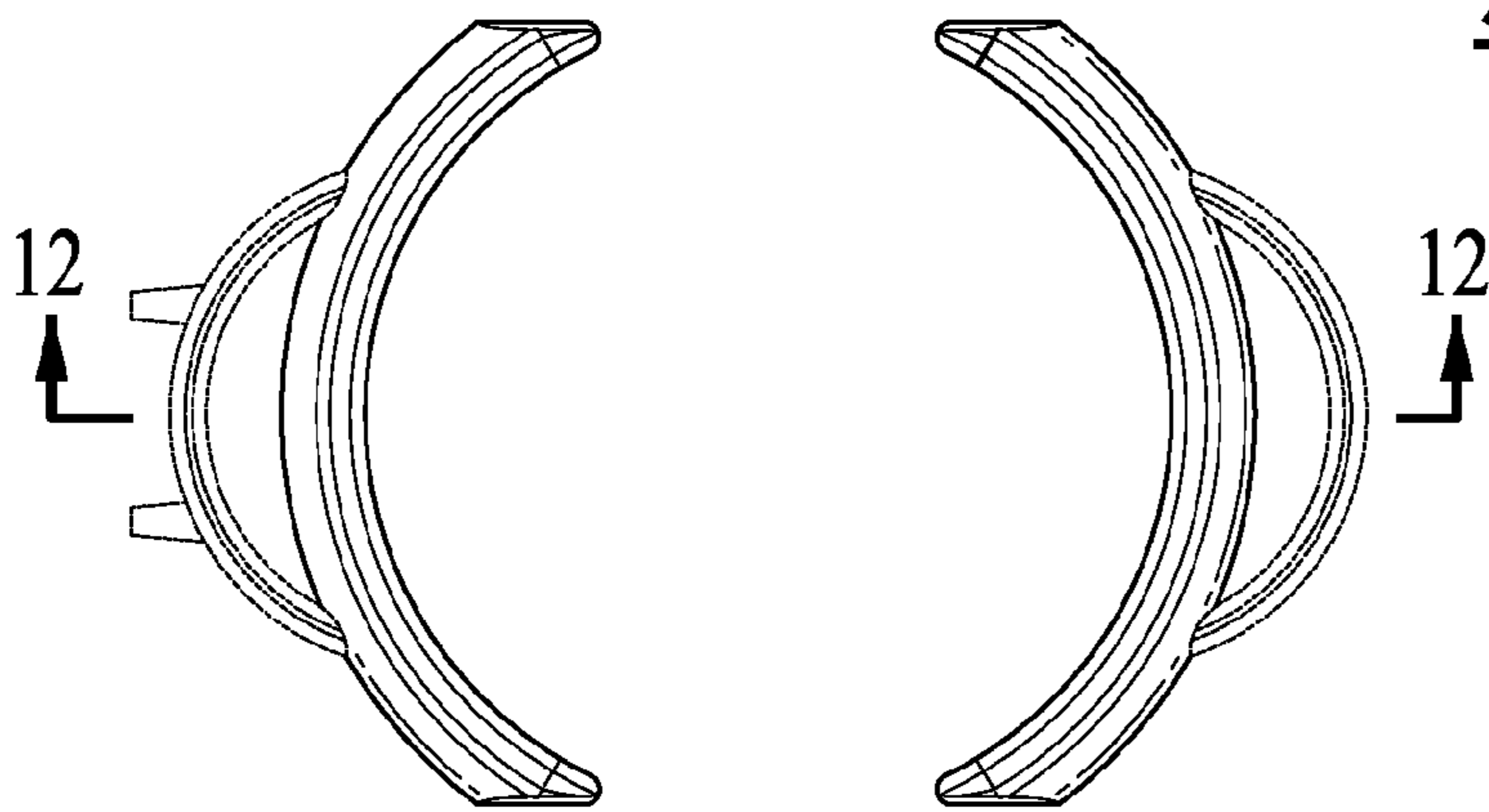

Fig. 8

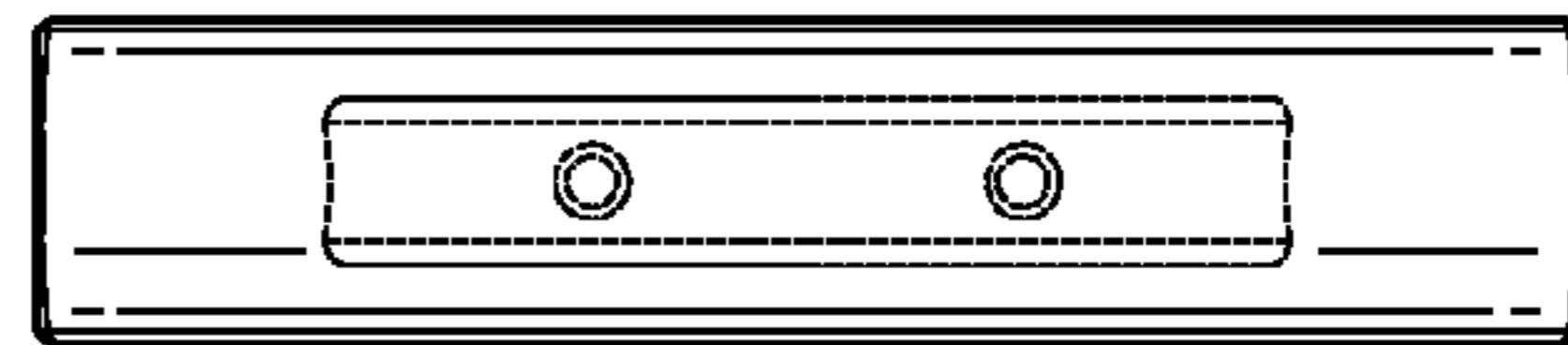

Fig. 10



Fig. 9

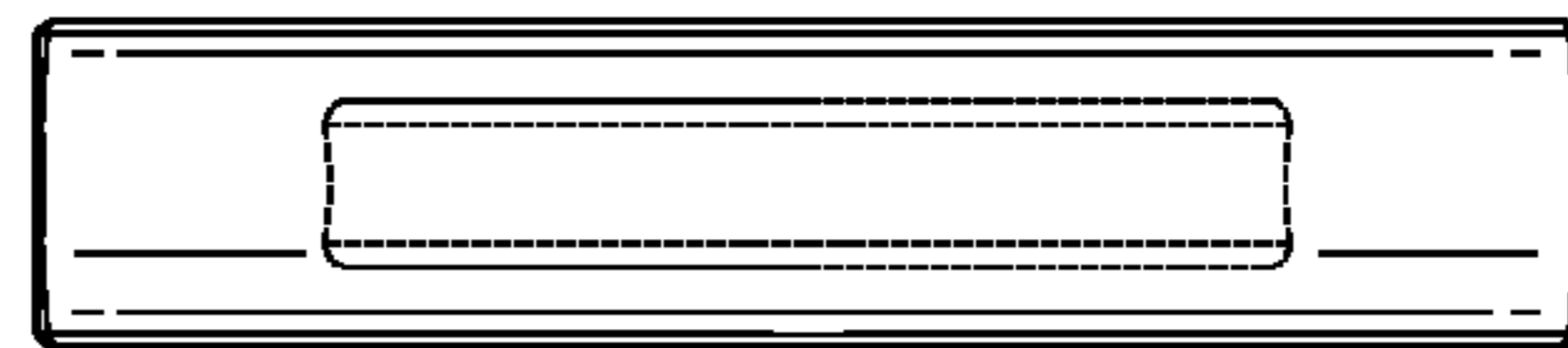

Fig. 11

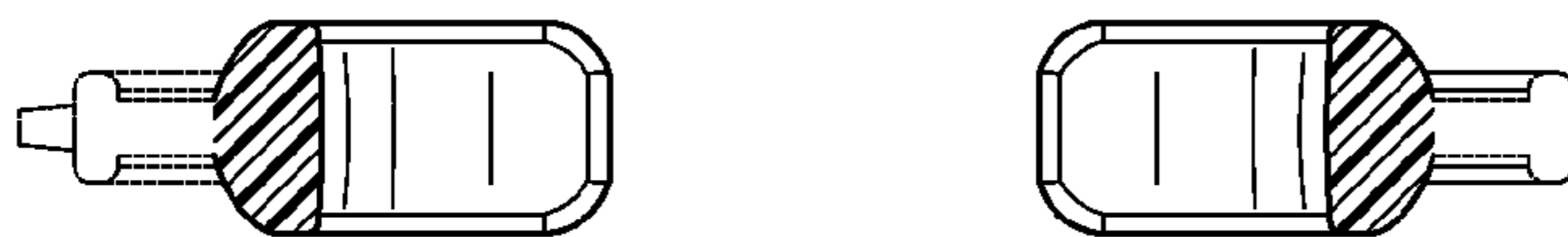

Fig. 12