



US00D684432S

(12) **United States Design Patent**  
**Stein et al.**

(10) **Patent No.:** **US D684,432 S**  
(45) **Date of Patent:** **\*\* Jun. 18, 2013**

(54) **BEVERAGE TOWER WRAP**  
(75) Inventors: **John Stein**, Ogden, UT (US); **Joseph C. Stein, III**, Ogden, UT (US); **Paul Carlsen**, North Ogden, UT (US)

(73) Assignee: **JPJ Tap Wrap LLC**, Ogden, UT (US)

(\*\*) Term: **14 Years**

(21) Appl. No.: **29/403,811**

(22) Filed: **Oct. 11, 2011**

(51) **LOC (9) Cl.** ..... **07-01**

(52) **U.S. Cl.**  
USPC ..... **D7/607; D7/624.2**

(58) **Field of Classification Search**  
USPC ..... D7/603-608, 624.2, 387; 62/389, 62/390, 529, 530, 457.1-457.9; 383/6, 7, 383/10, 2, 95, 109, 110, 113; 220/592.17, 220/592.24, 737-739, 902, 903, 592.16, 220/592.2, 592.27

See application file for complete search history.

(56) **References Cited**

**U.S. PATENT DOCUMENTS**

5,537,825	A	7/1996	Ward	
5,694,787	A	12/1997	Cleland et al.	
5,743,107	A	4/1998	Kyees	
5,845,806	A	12/1998	Parchman	
6,375,042	B1	4/2002	Goodwin	
7,040,359	B2	5/2006	Younkle	
7,228,987	B2	6/2007	Jones	
D585,705	S *	2/2009	Weers et al.	D7/607
D589,758	S *	4/2009	Mancha et al.	D7/624.2
D590,212	S *	4/2009	Mancha et al.	D7/624.2
D614,001	S *	4/2010	Welch	D7/605
7,721,567	B2	5/2010	Dalton et al.	
7,743,624	B2	6/2010	Schneller et al.	
7,823,411	B2	11/2010	Gagliano et al.	
2004/0178203	A1	9/2004	Rau	
2005/0023292	A1 *	2/2005	Market et al.	222/183
2005/0139081	A1	6/2005	Lima	

2006/0272348 A1 12/2006 Kyees et al.  
2007/0017924 A1 1/2007 Hundley  
2007/0056296 A1 3/2007 Gagliano  
2009/0090642 A1 4/2009 Trimarco

**FOREIGN PATENT DOCUMENTS**

GB 2379728 3/2003

**OTHER PUBLICATIONS**

U.S. Appl. No. 61/545,852, filed Oct. 11, 2011, Stein et al. www.yelp.com ; Michael Gaynor, The Official All Tapped Out beer tap cover, Source: http://www.yelp.com/biz\_photos/Ai-1Q\_oMwpzNkDe6c58xsA?select=ZE7ektK2qDJZhW8\_7aS8eg, retrieved Jun. 20, 2011; 6 pages.  
LinkedIn; Michael Gaynor; All Tapped Out; Retrieved Jun. 20, 2011; 2 pages.

\* cited by examiner

*Primary Examiner* — Terry Wallace

(74) *Attorney, Agent, or Firm* — Workman Nydegger

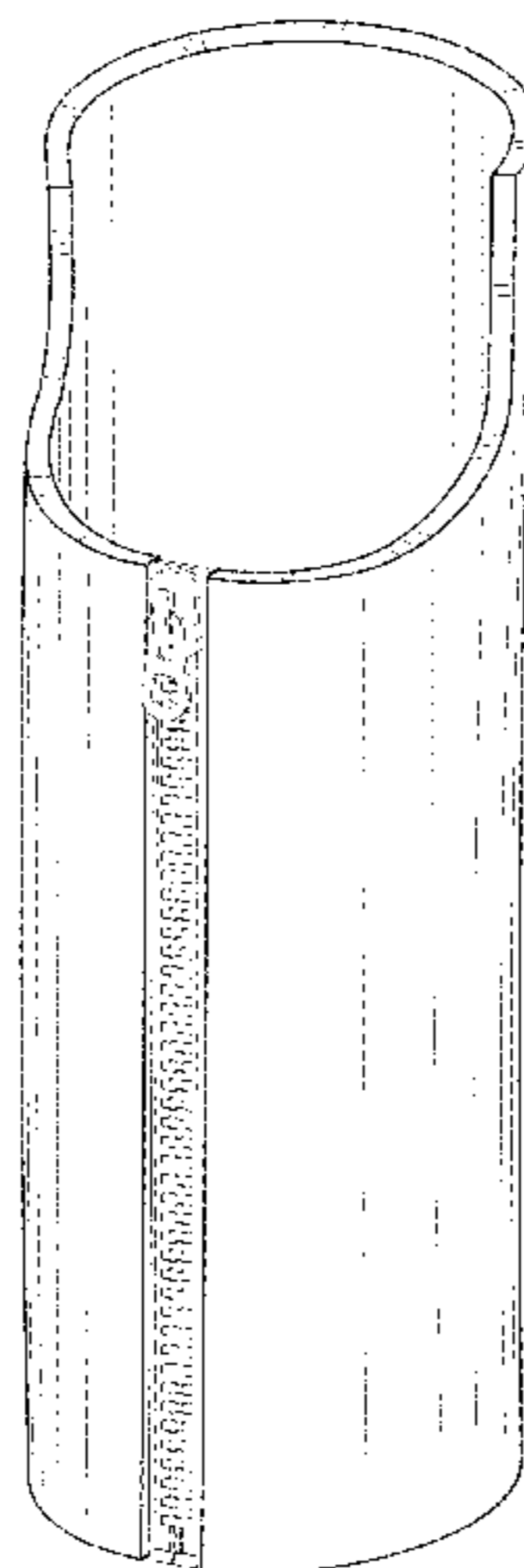
(57) **CLAIM**

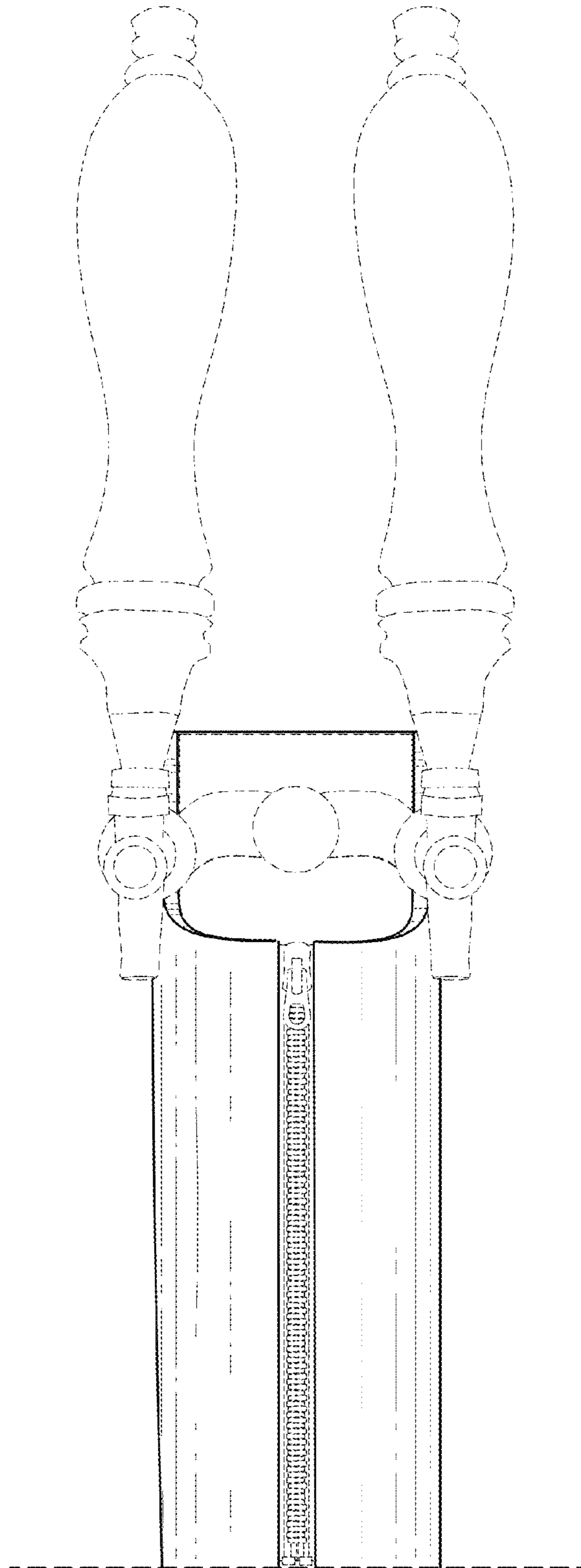
The ornamental design for a beverage tower wrap, as shown and described.

**DESCRIPTION**

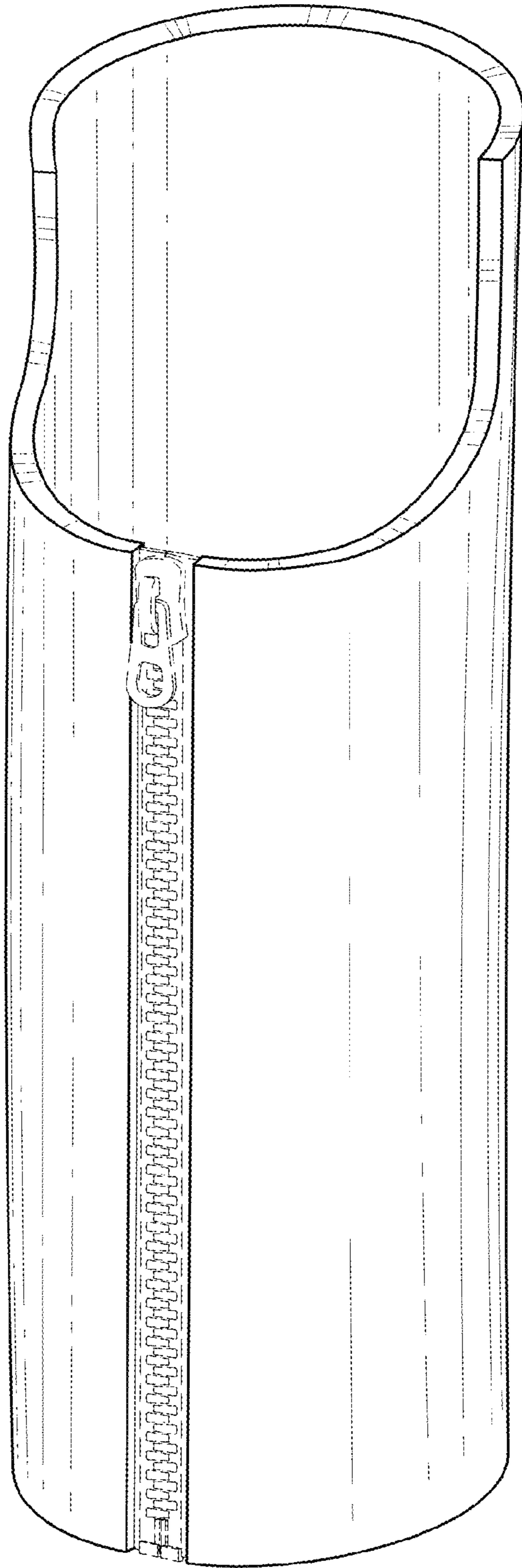
FIG. 1 is a front environmental view of a beverage tower wrap installed around a beverage tower;  
FIG. 2 is a perspective view thereof;  
FIG. 3 is front elevational view thereof;  
FIG. 4 is a left elevational view thereof;  
FIG. 5 is a right elevational view thereof;  
FIG. 6 is a rear elevational view thereof;  
FIG. 7 is a top plan view thereof;  
FIG. 8 is a bottom plan view thereof; and,  
FIG. 9 is a perspective view thereof in an alternate, open position.  
The broken lines showing environment in the drawings are included for illustrative purposes only and form no part of the claimed design.

**1 Claim, 8 Drawing Sheets**

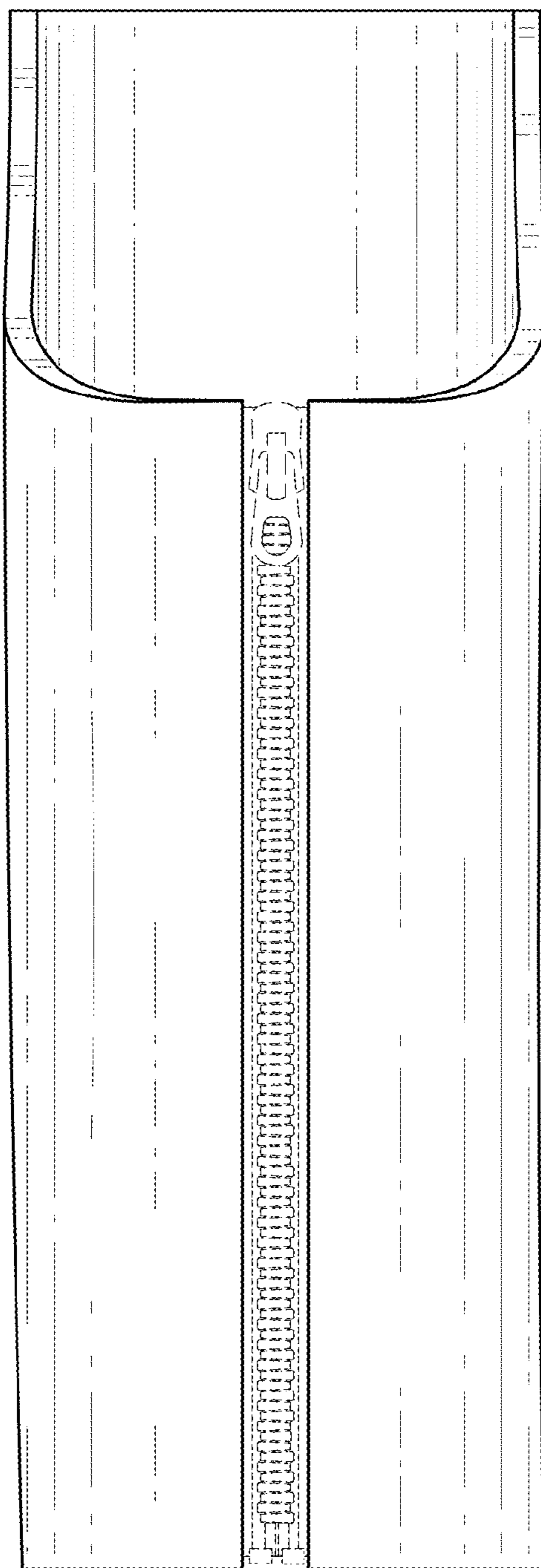




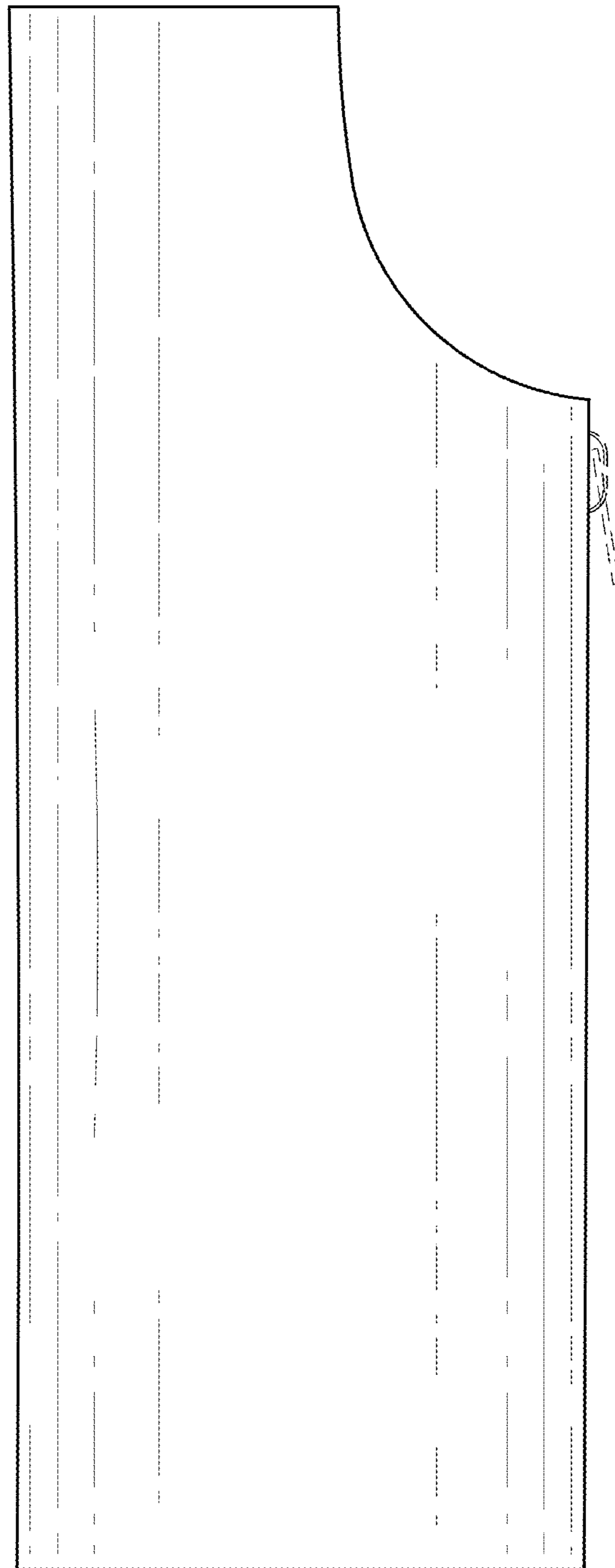
**Fig. 1**



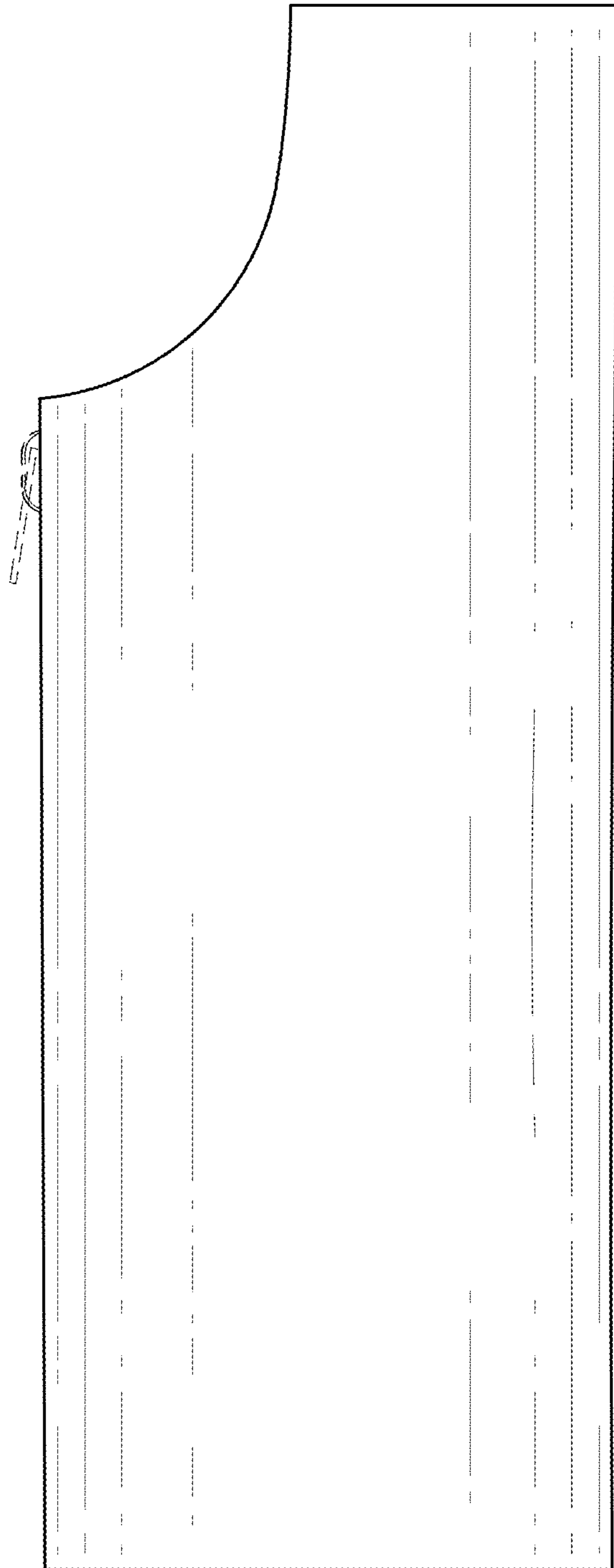
**Fig. 2**



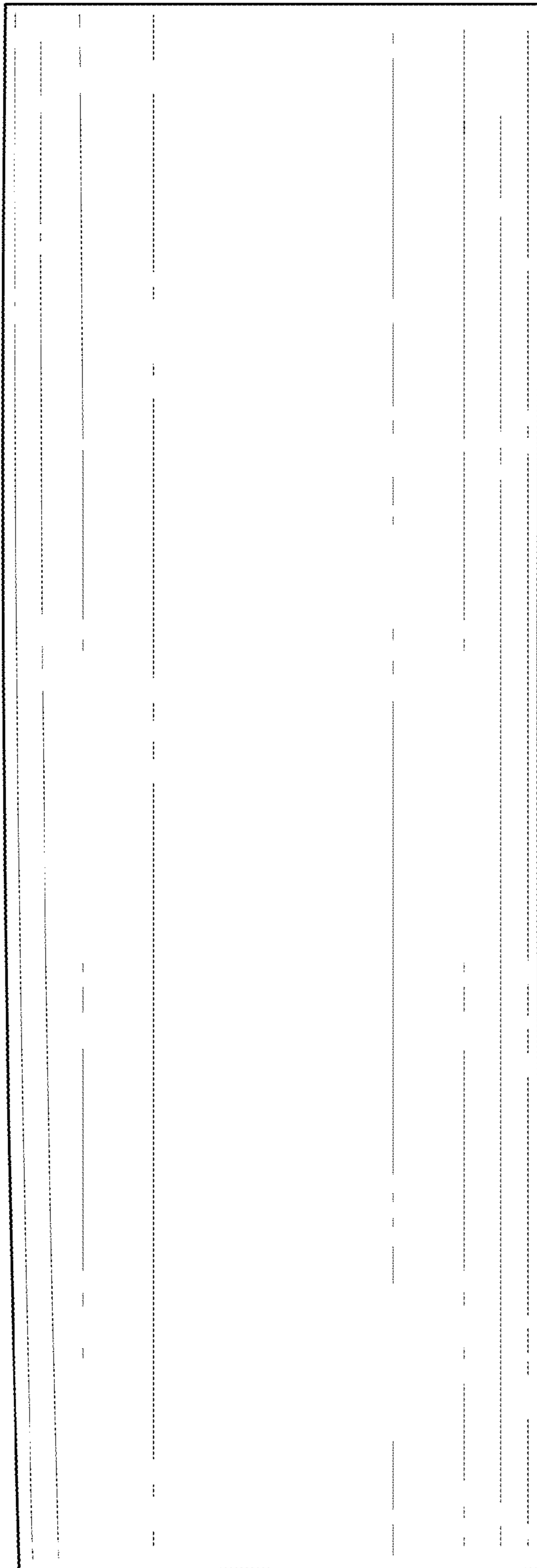
**Fig. 3**



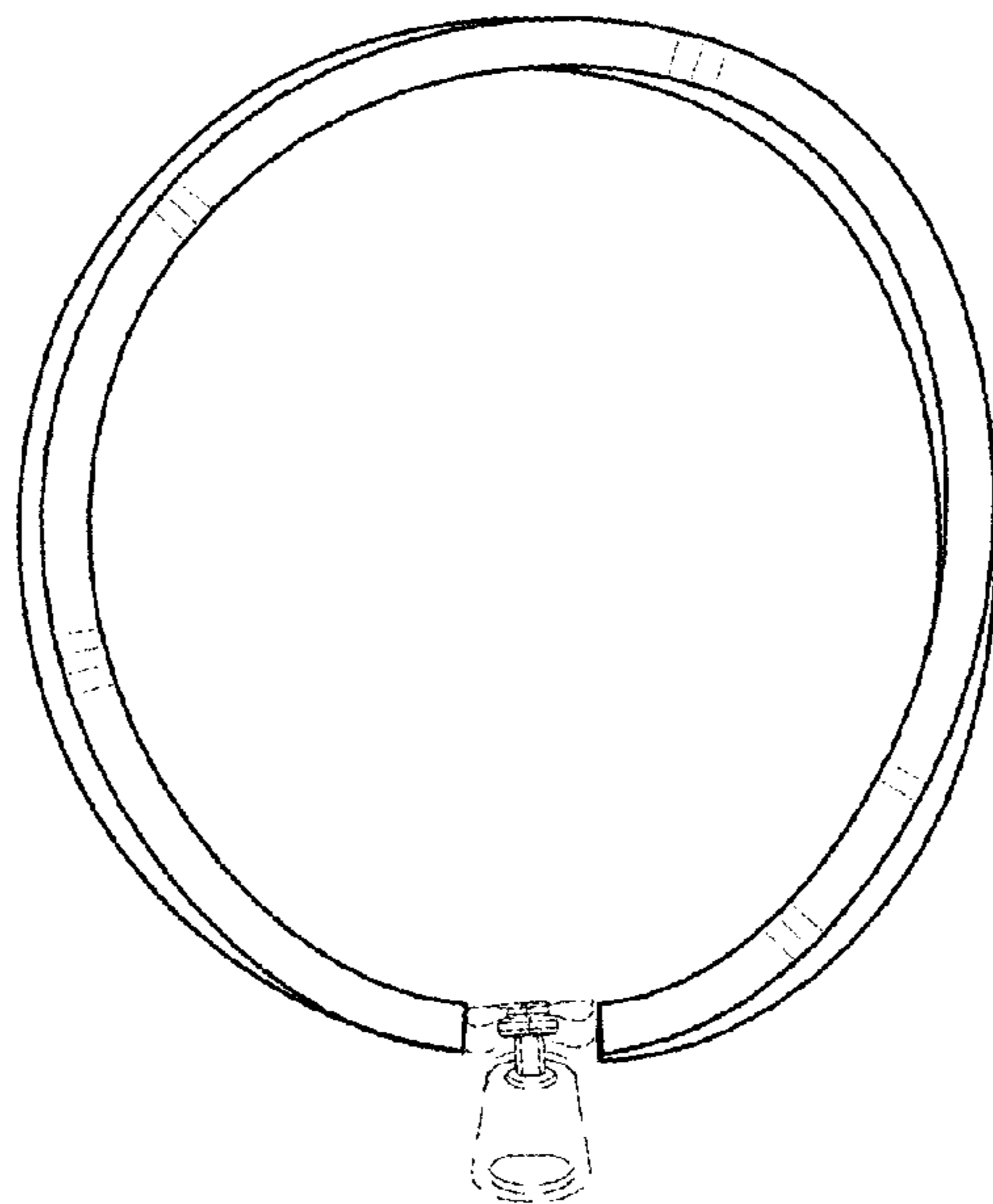
**Fig. 4**



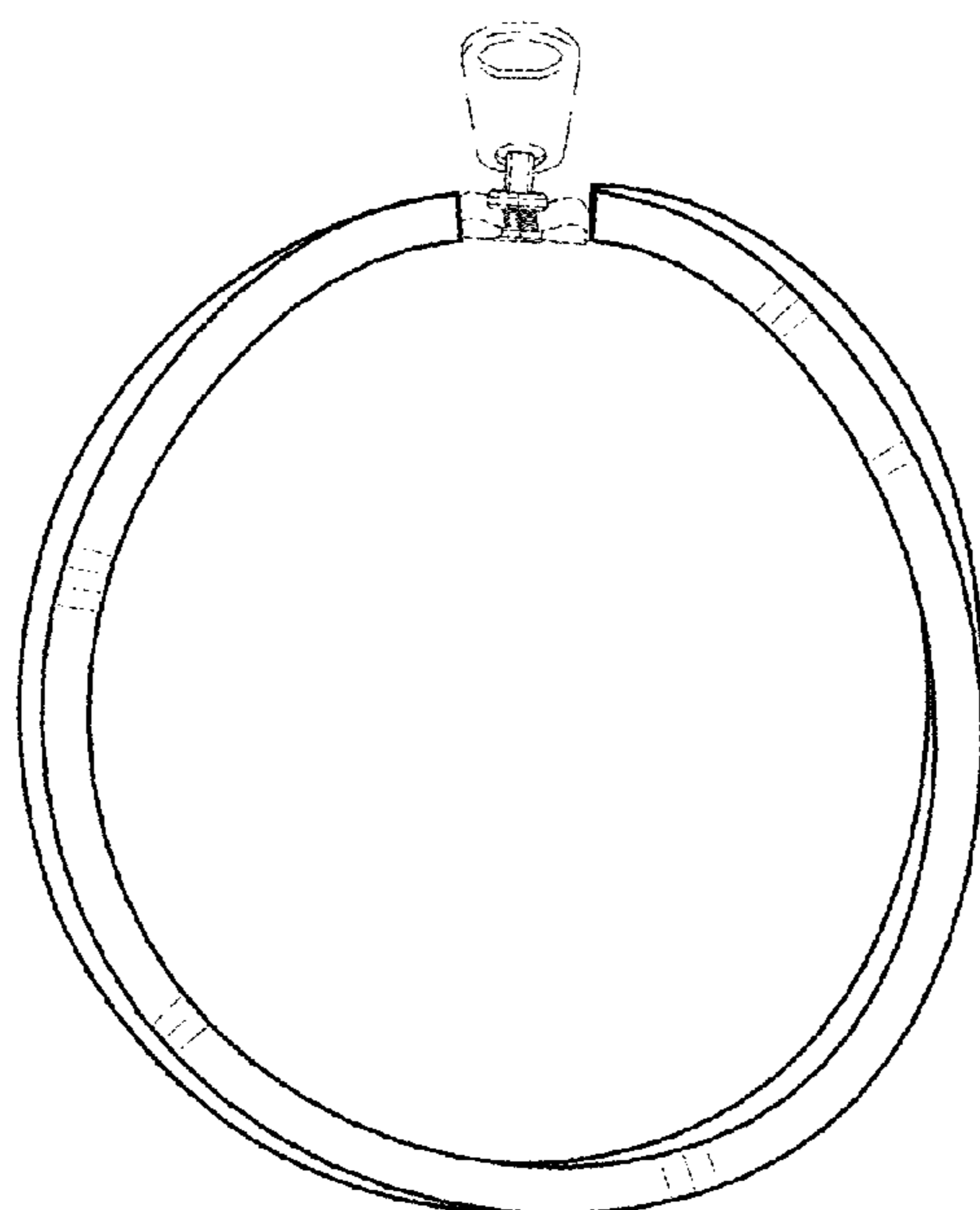
**Fig. 5**



**Fig. 6**



**Fig. 7**



**Fig. 8**



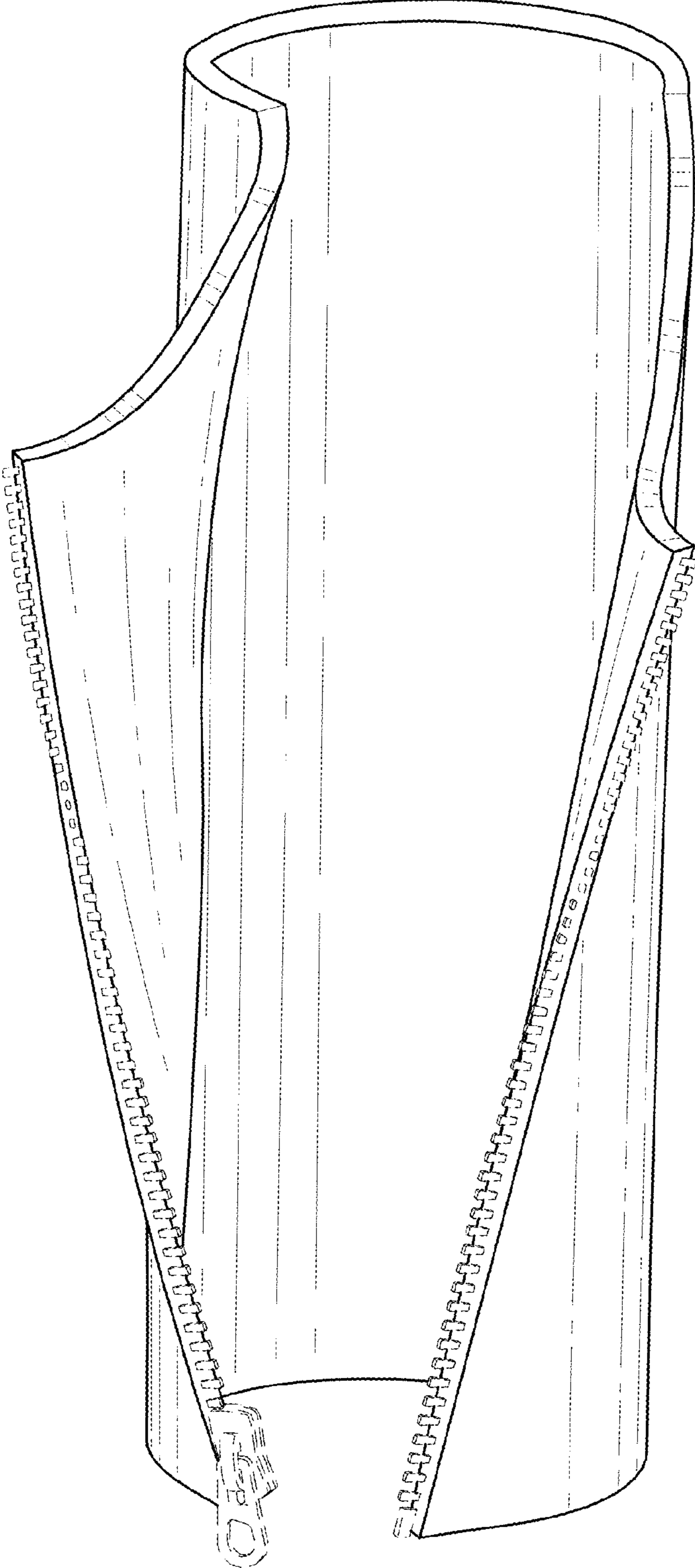


Fig. 9