



US00D684429S

(12) **United States Design Patent**
Lion et al.

(10) **Patent No.:** **US D684,429 S**

(45) **Date of Patent:** **** Jun. 18, 2013**

(54) **BOWL**

(75) Inventors: **Mathieu Lion**, Paris (FR); **Bérengère Suquet**, Paris (FR)

(73) Assignee: **Mastrad, S.A.**, Paris (FR)

(**) Term: **14 Years**

(21) Appl. No.: **29/427,119**

(22) Filed: **Jul. 13, 2012**

(51) **LOC (9) Cl.** **07-01**

(52) **U.S. Cl.**
USPC **D7/543**

(58) **Field of Classification Search**
USPC D7/501, 505, 538, 543, 545, 500,
D7/590, 360, 600.2, 553.6, 392.1, 601, 354,
D7/555, 557, 566, 620, 629, 552.1, 589, 586;
D9/743, 745; 220/751, 23.4, 574; 206/514;
73/426

See application file for complete search history.

(56) **References Cited**

U.S. PATENT DOCUMENTS

D222,177 S *	10/1971	Tondu	D7/543
D347,969 S *	6/1994	Cousins et al.	D7/548
5,423,452 A *	6/1995	Tardif	220/574
D477,186 S *	7/2003	de Groote et al.	D7/543
D484,363 S *	12/2003	de Groote et al.	D7/543
D522,313 S *	6/2006	Oyler et al.	D7/543
D522,809 S *	6/2006	Kusuma et al.	D7/602
D524,603 S *	7/2006	Kishbaugh et al.	D7/543
D526,850 S *	8/2006	Sellers et al.	D7/543

D538,599 S *	3/2007	Miller	D7/586
D543,074 S *	5/2007	Luft	D7/543
D545,629 S *	7/2007	Mellen et al.	D7/543
D564,138 S *	3/2008	Dunn et al.	D30/129
D571,614 S *	6/2008	Curtin	D7/545
D619,421 S *	7/2010	France et al.	D7/586
D625,956 S *	10/2010	Goddard-Clark et al.	D7/543
D627,198 S *	11/2010	Hull et al.	D7/587
D639,115 S *	6/2011	Stewart et al.	D7/543
D643,248 S *	8/2011	Schmidt	D7/505
D645,705 S *	9/2011	Shamoon	D7/543
D656,792 S *	4/2012	Sink et al.	D7/586
2005/0127073 A1 *	6/2005	Kusuma et al.	220/6
2010/0170840 A1 *	7/2010	Curtin	210/232

* cited by examiner

Primary Examiner — Cynthia Underwood

(74) *Attorney, Agent, or Firm* — Novak Druce Connolly Bove + Quigg LLP

(57) **CLAIM**

The ornamental design for a bowl, as shown and described.

DESCRIPTION

FIG. 1 is a perspective view of the bowl;
FIG. 2 is top plan view of the bowl;
FIG. 3 is a bottom plan view of the bowl;
FIG. 4 is a front side view of the bowl of FIG. 2;
FIG. 5 is the rear view of the bowl of FIG. 2;
FIG. 6 is a right side view of the bowl of FIG. 2;
FIG. 7 is a left side view of the bowl of FIG. 2; and,
FIG. 8 is a cross-sectional view taken along 8-8 of the bowl of FIG. 6.

1 Claim, 8 Drawing Sheets

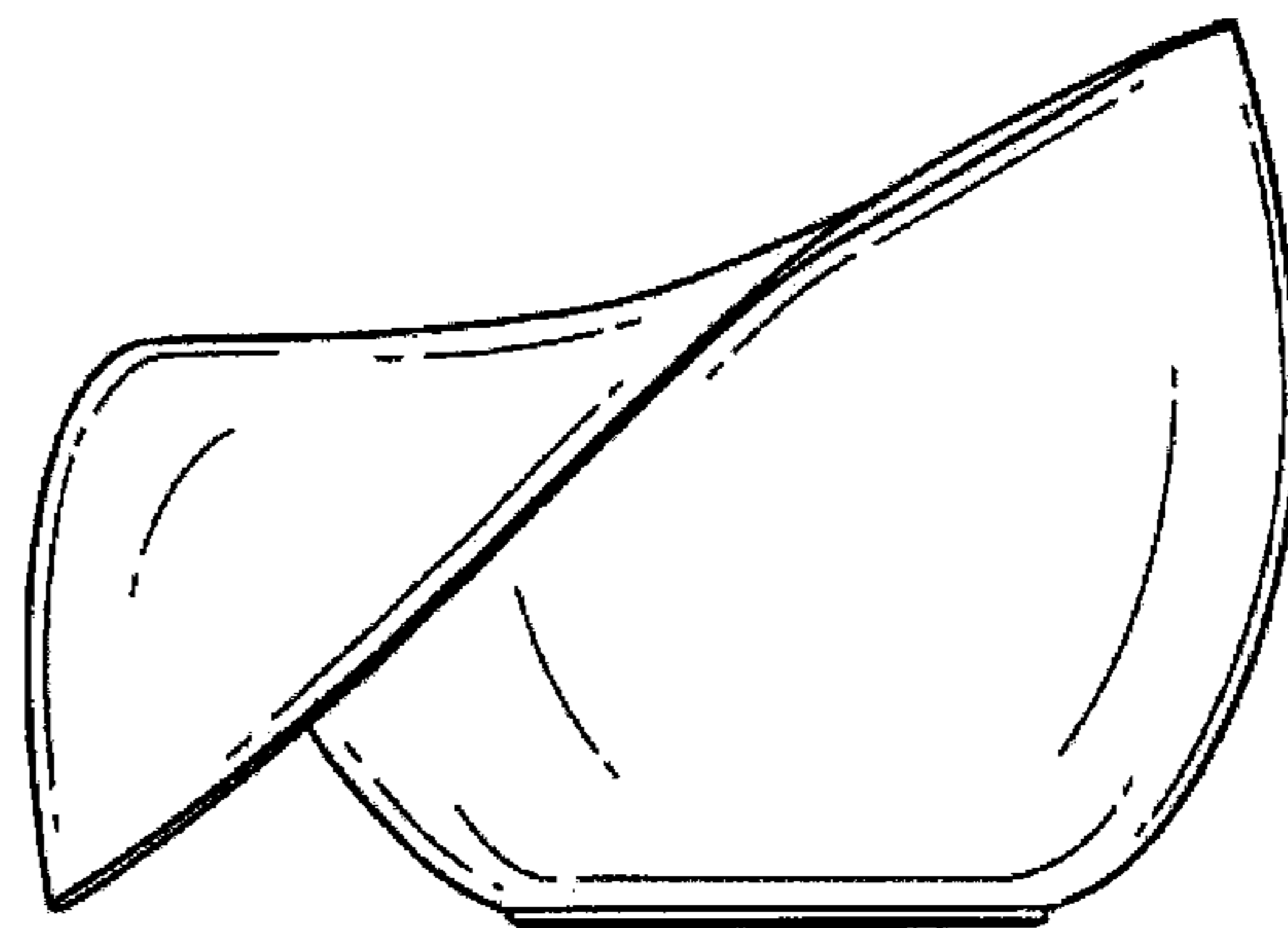
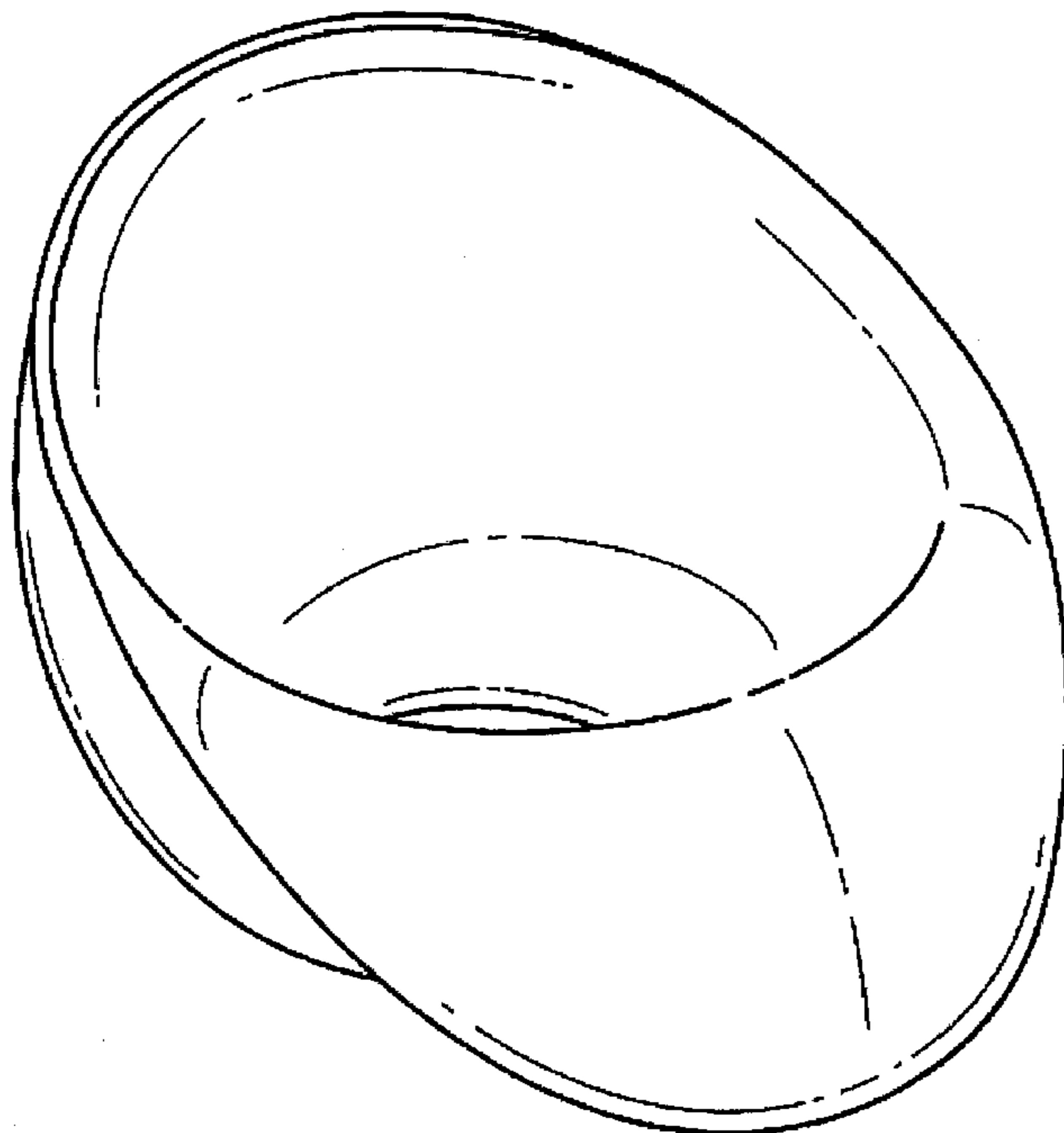

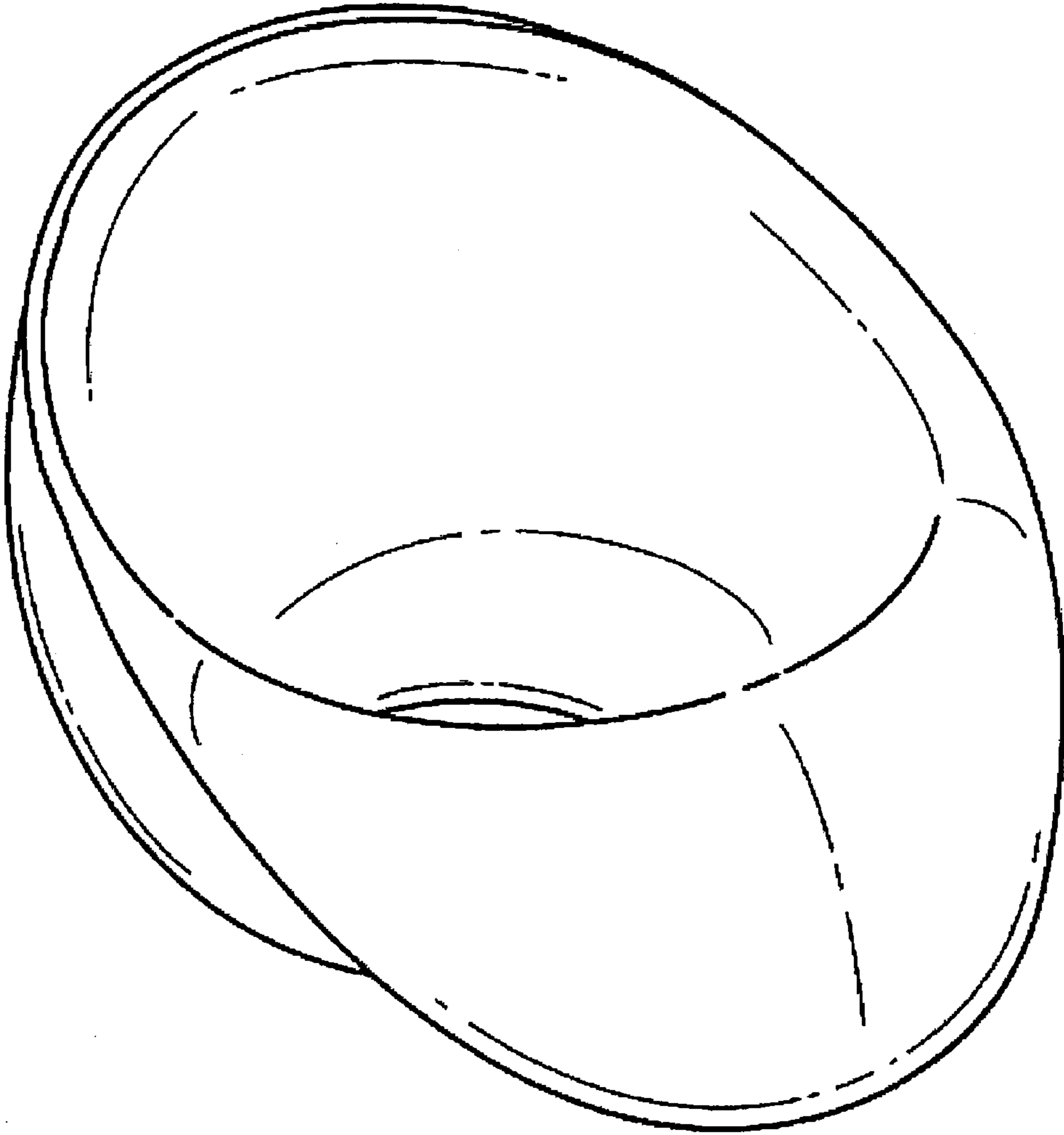

Fig. 1

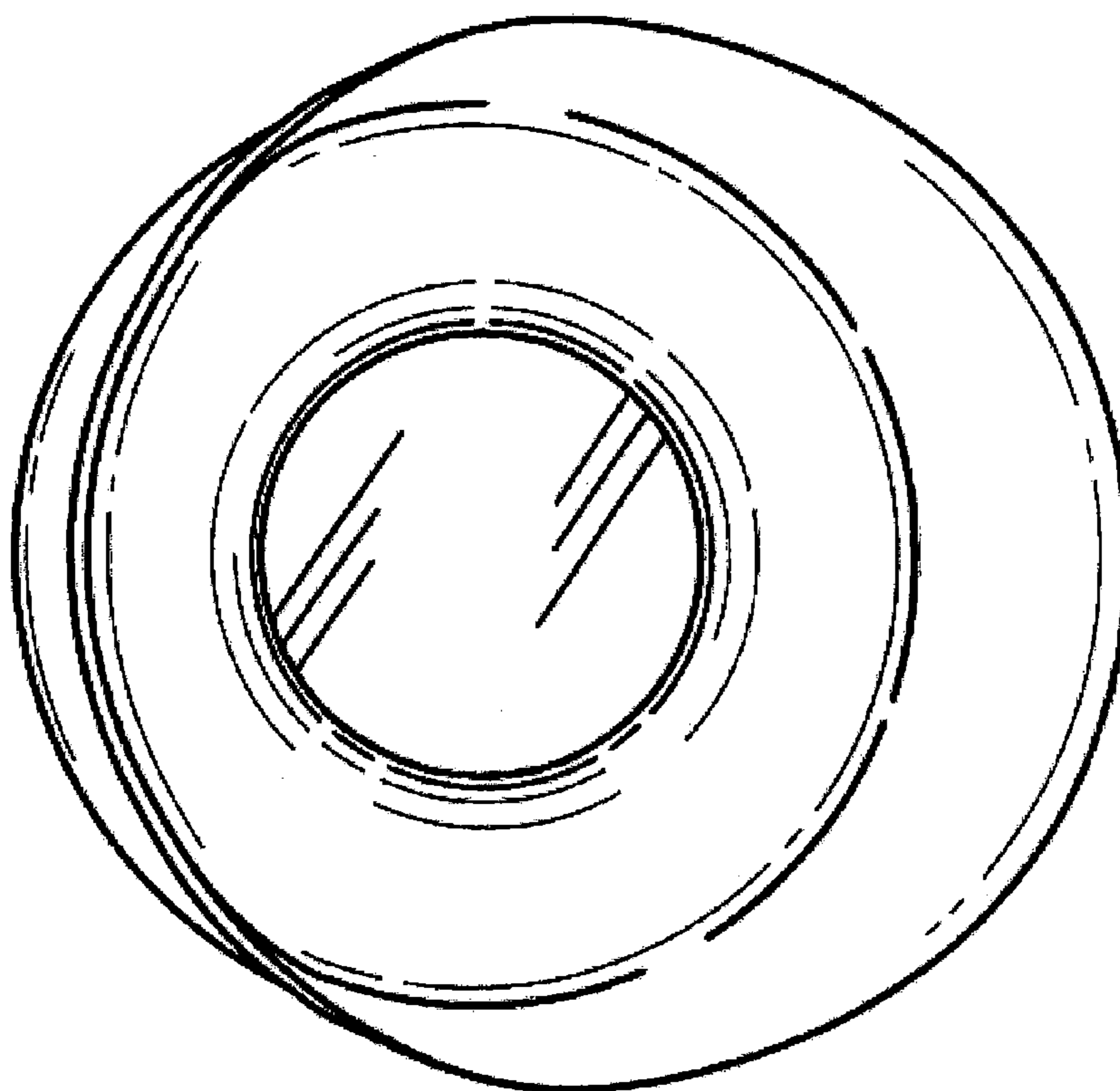

Fig. 2

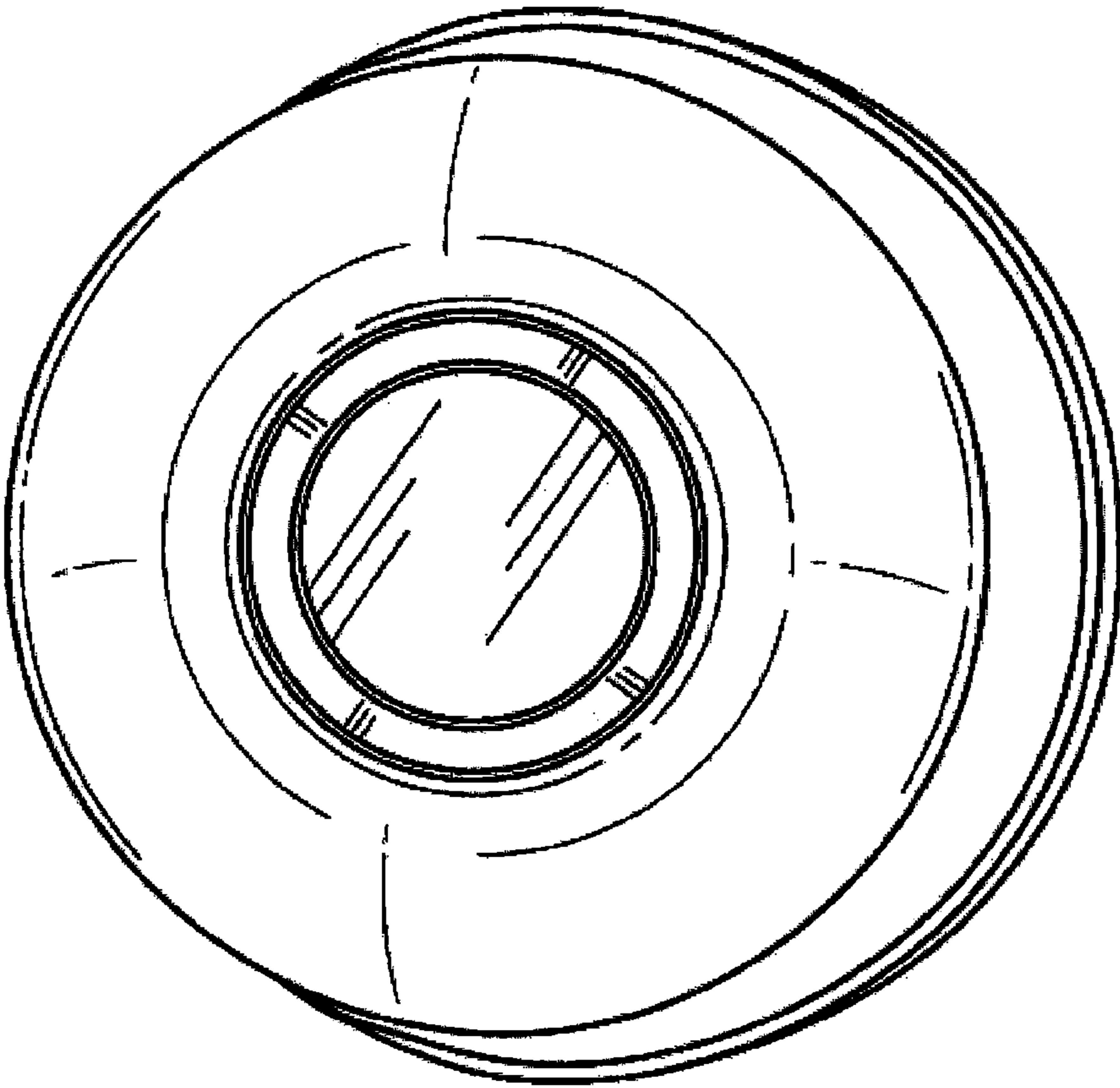

Fig. 3

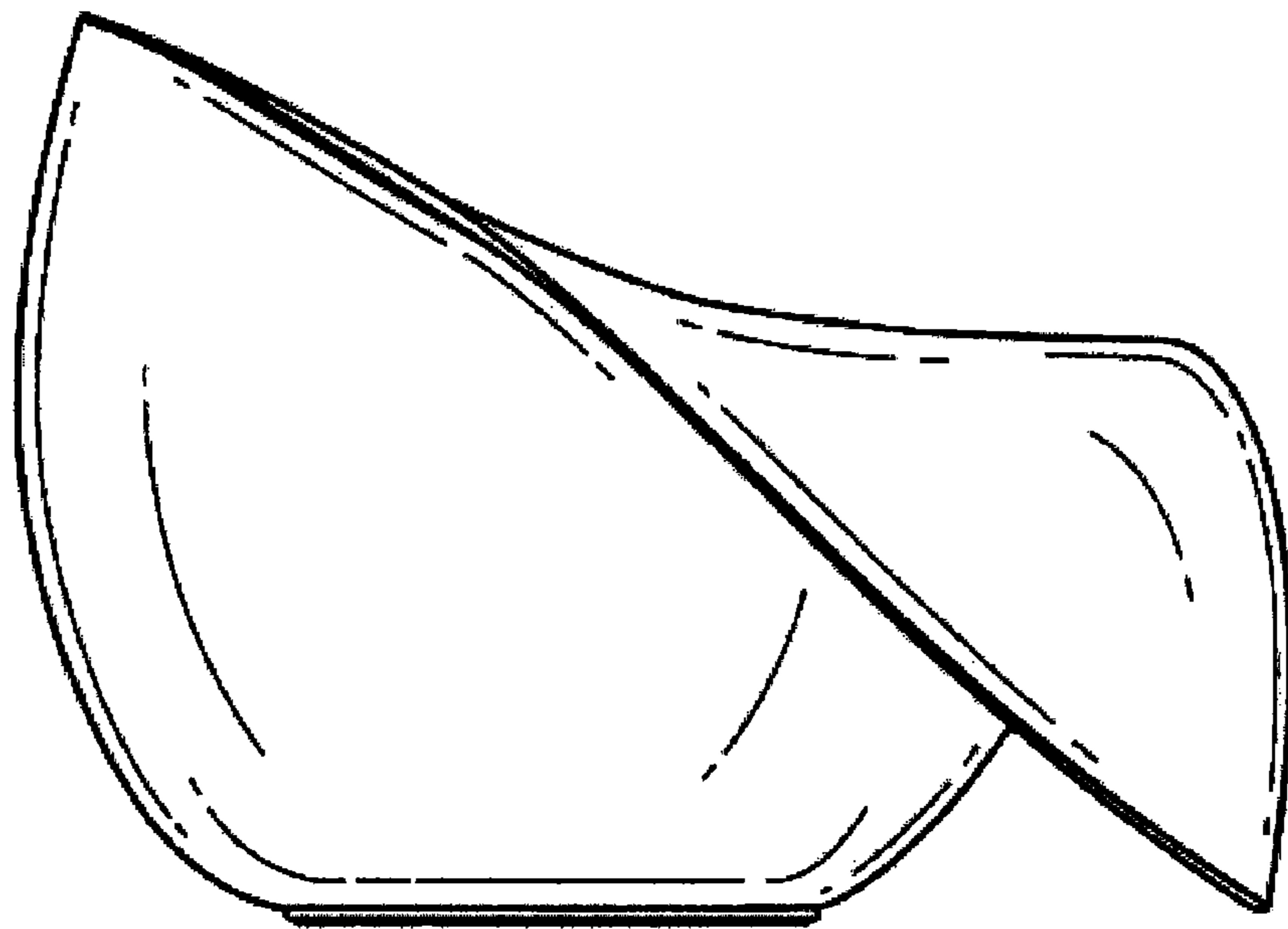

Fig. 4

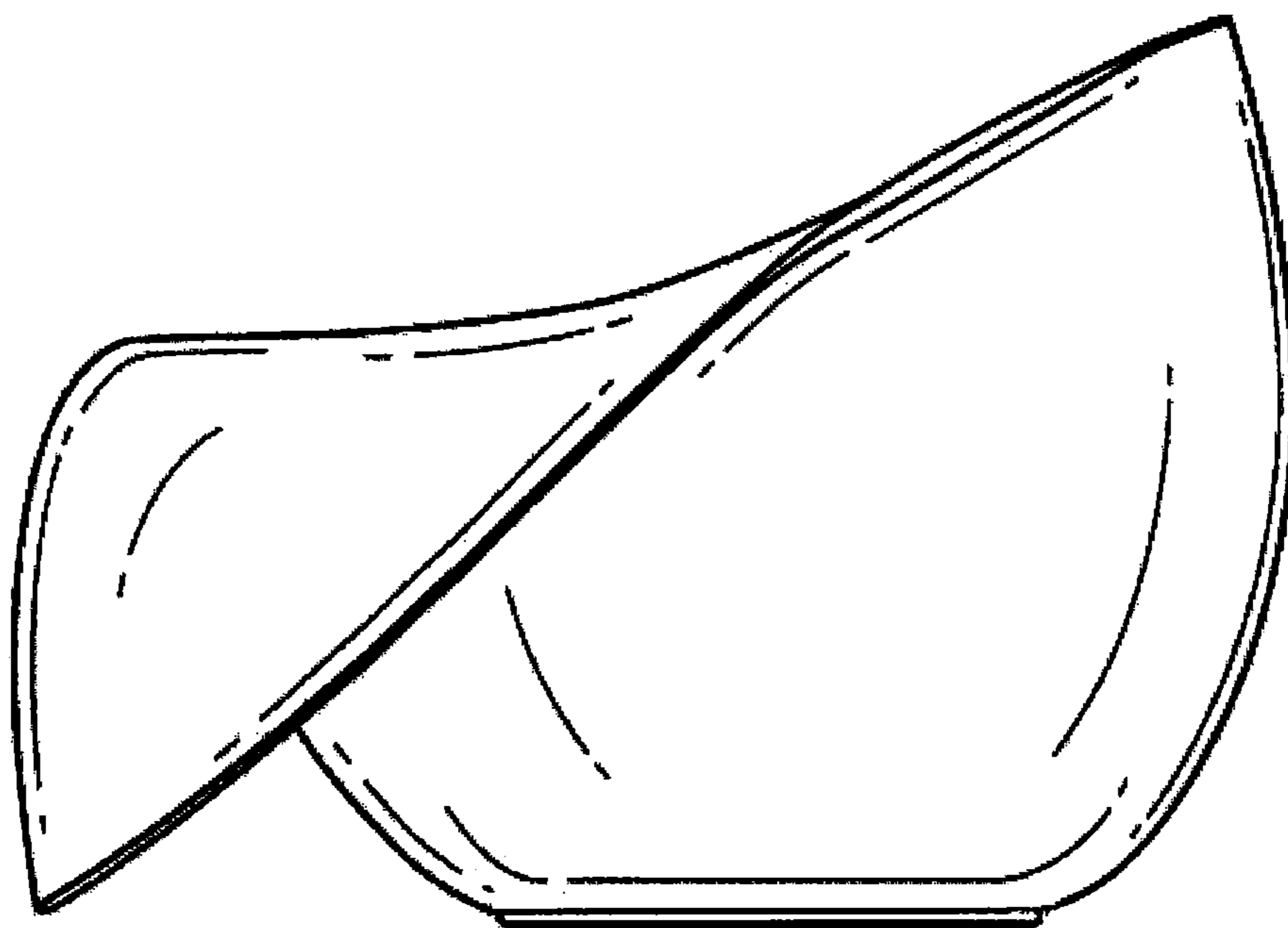

Fig. 5

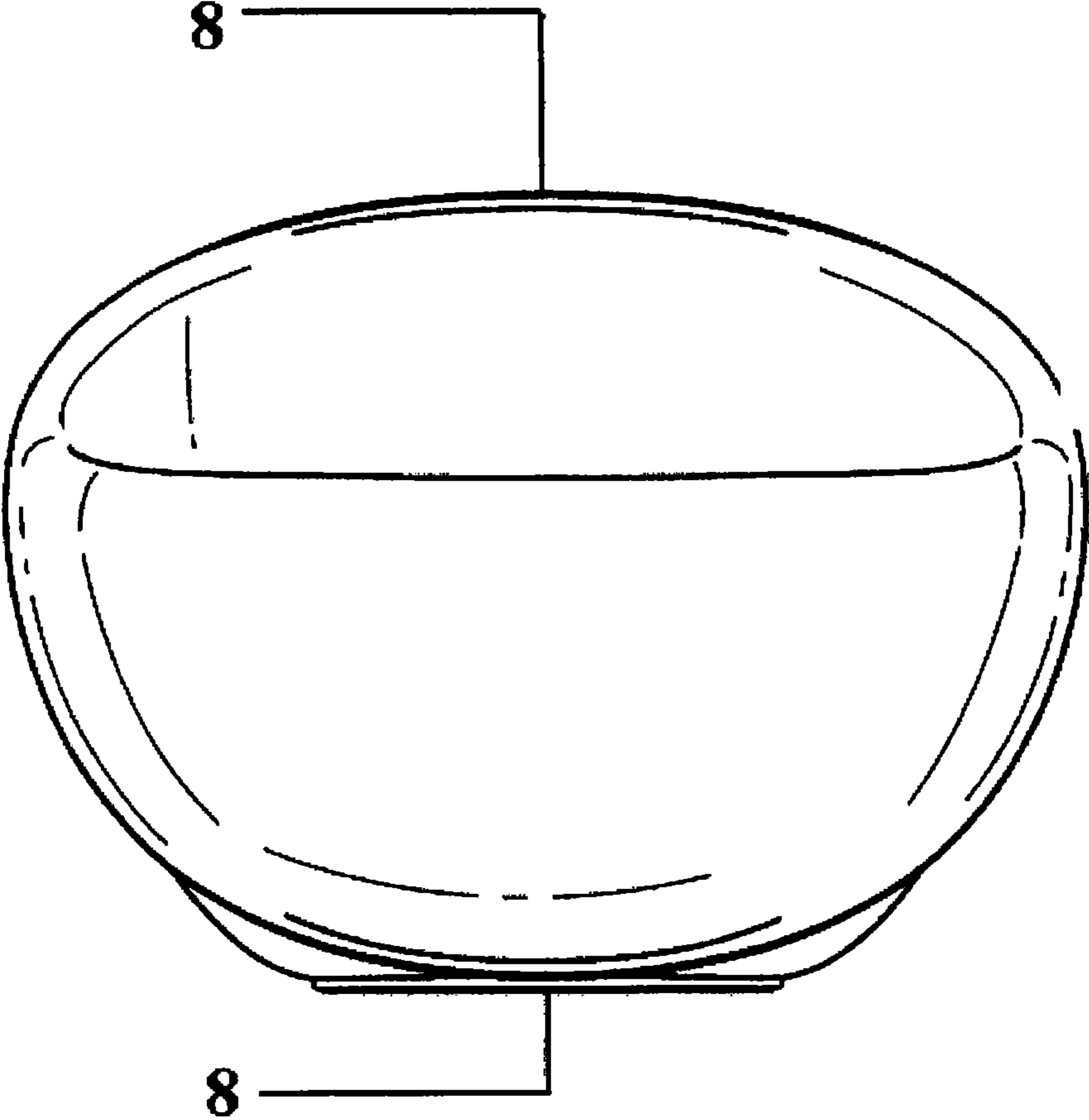

Fig. 6

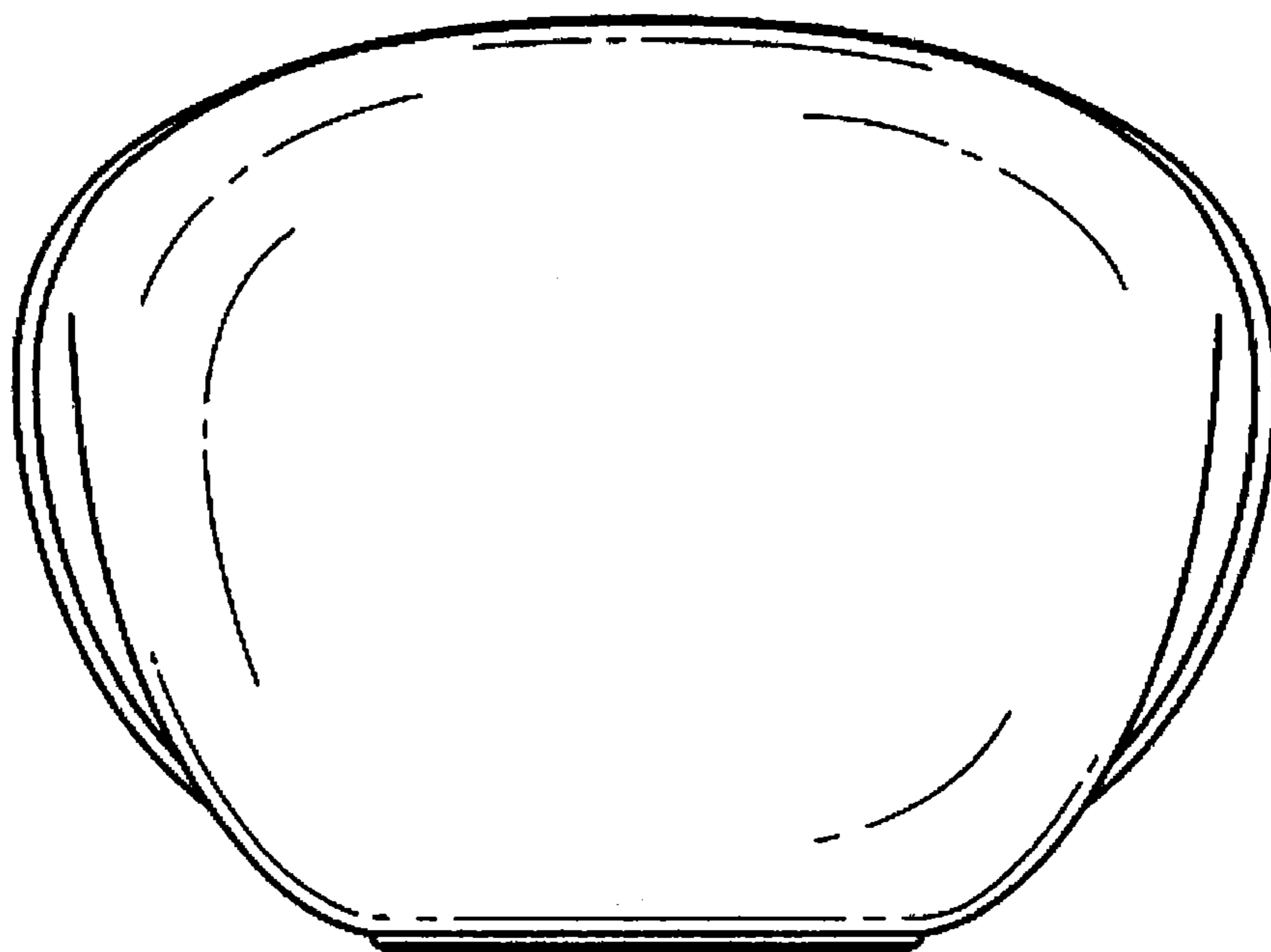

Fig. 7

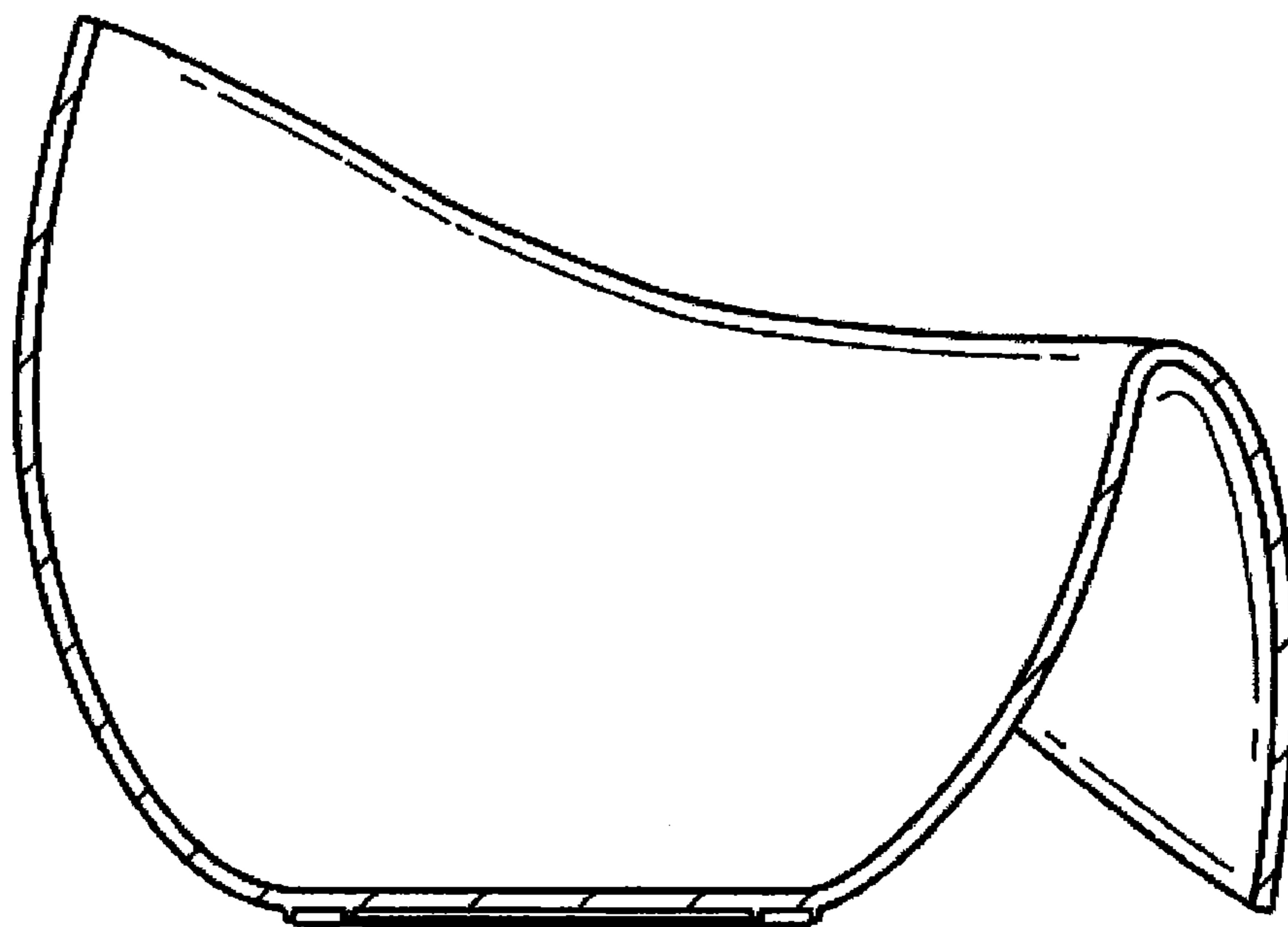

Fig. 8