



US00D684425S

(12) **United States Design Patent**
Nordwall

(10) **Patent No.:** **US D684,425 S**

(45) **Date of Patent:** **** Jun. 18, 2013**

(54) **PADDLE**

(71) Applicant: **Electrolux Professional S.p.A.**,
Pordenone (IT)

(72) Inventor: **Joachim Nordwall**, Stockholm (SE)

(73) Assignee: **Electrolux Professional S.p.A.** (IT)

(**) Term: **14 Years**

(21) Appl. No.: **29/434,640**

(22) Filed: **Oct. 15, 2012**

(30) **Foreign Application Priority Data**

Apr. 13, 2012 (EM) 002025304-0005
Apr. 13, 2012 (EM) 002025304-0006

(51) **LOC (9) Cl.** **07-02**

(52) **U.S. Cl.**
USPC **D7/412; D7/379**

(58) **Field of Classification Search**
USPC D7/301-313, 316-319, 356-357,
D7/368, 372-386, 391-398, 412-415, 503,
D7/515, 665, 679, 691-693, 706; 99/275,
99/287, 326, 348, 492, 508-512; 219/209;
241/30-37.5, 82.4, 101.01-101.2, 166-169.1,
241/172, 272, 285.1-285.3, 291, 292.1;
366/64-67, 97-100, 130, 142-144, 192-212,
366/241-254, 262, 279-292, 309-313, 325.8,
366/325.92, 331, 341-347; 403/348-349;
416/75-77, 70 R, 163, 227 R; 474/31; 475/11
See application file for complete search history.

(56) **References Cited**

U.S. PATENT DOCUMENTS

1,264,128 A * 4/1918 Rataiczak et. al. 366/207
1,656,665 A * 1/1928 Dehuff 475/11
1,781,321 A * 11/1930 Dehuff 474/31

1,785,562 A * 12/1930 Schiff 475/11
1,792,363 A * 2/1931 Dehuff 403/348
2,046,784 A * 7/1936 Krause 219/209
2,109,614 A * 3/1938 Dehuff 416/227 R
2,178,269 A * 10/1939 Seybert 366/313
2,181,078 A * 11/1939 Dehuff 366/309
2,318,534 A * 5/1943 Seybert 366/312
4,946,285 A * 8/1990 Vennemeyer 366/288
5,556,201 A * 9/1996 Veltrop et al. 366/203
5,934,802 A * 8/1999 Xie 366/100
D438,424 S * 3/2001 Po-Hei D7/379
D447,907 S * 9/2001 Po-Hei D7/379
D488,956 S * 4/2004 Boyle et al. D7/412
7,270,473 B2 * 9/2007 Donthnier et al. 366/309
7,314,308 B2 * 1/2008 Fallowes et al. 366/310

(Continued)

Primary Examiner — Ricky Pham

(74) *Attorney, Agent, or Firm* — Banner & Witcoff, Ltd.

(57) **CLAIM**

The ornamental design for a paddle, as shown and described.

DESCRIPTION

FIG. 1 is a perspective view of a paddle showing my new design;
FIG. 2 is a front view thereof;
FIG. 3 is a top view thereof;
FIG. 4 is a bottom view thereof;
FIG. 5 is a left side view thereof;
FIG. 6 is a right side view thereof;
FIG. 7 is a rear view thereof;
CAD representation style;
FIG. 8 is a perspective view of a paddle showing my new design;
FIG. 9 is a front view thereof;
FIG. 10 is a top view thereof;
FIG. 11 is a bottom view thereof;
FIG. 12 is a left side view thereof;
FIG. 13 is a right side view thereof; and,
FIG. 14 is a rear view thereof.

1 Claim, 14 Drawing Sheets

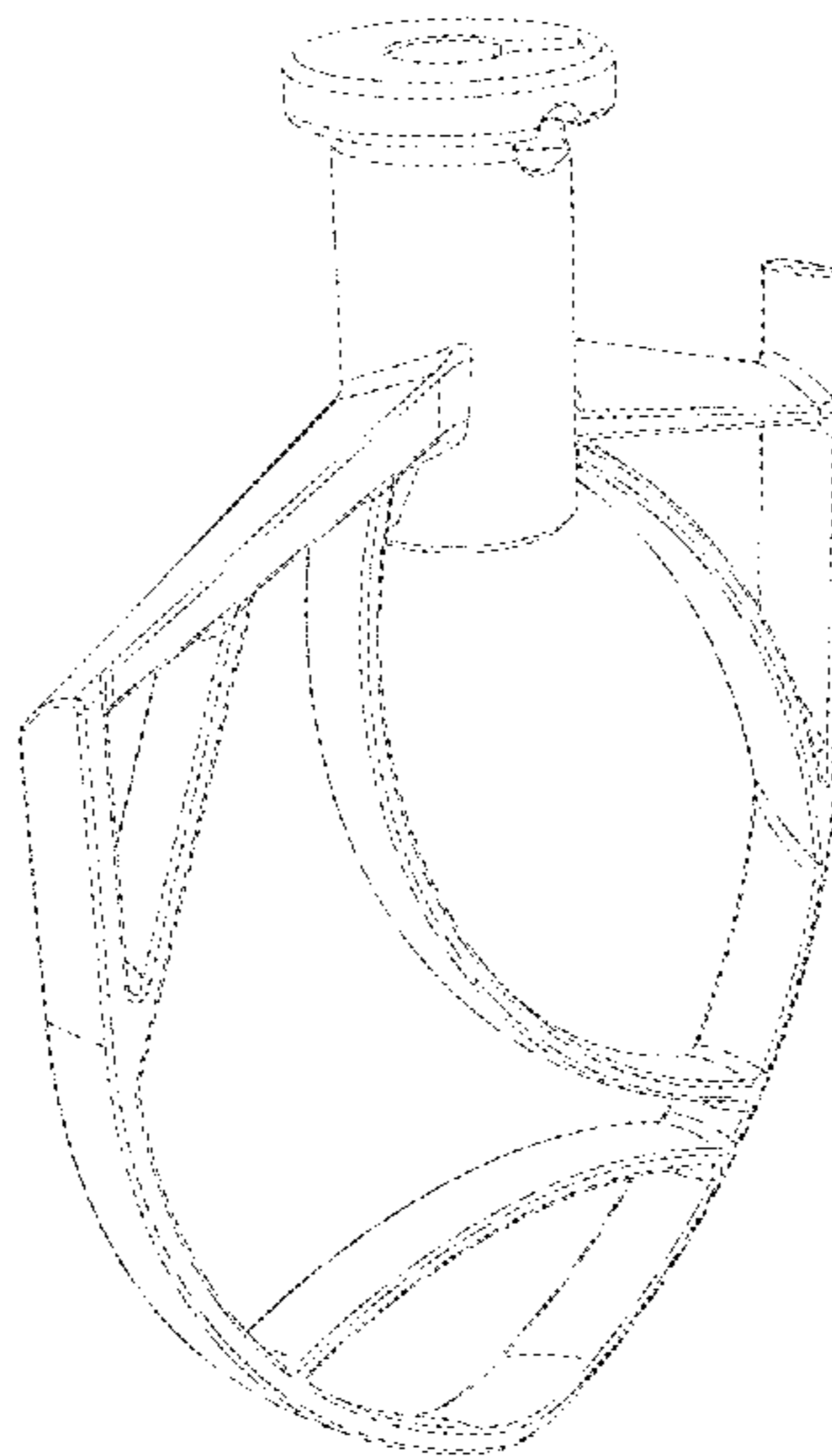

US D684,425 S

Page 2

U.S. PATENT DOCUMENTS								
7,690,836	B2 *	4/2010	Busick	366/313	2006/0171251	A1 *	8/2006 Busick	366/312
D616,699	S *	6/2010	Hoare et al.	D7/379	2006/0268659	A1 *	11/2006 Kaas	366/312
D664,807	S *	8/2012	Annis et al.	D7/412	2012/0081993	A1 *	4/2012 Annis et al.	366/309

* cited by examiner

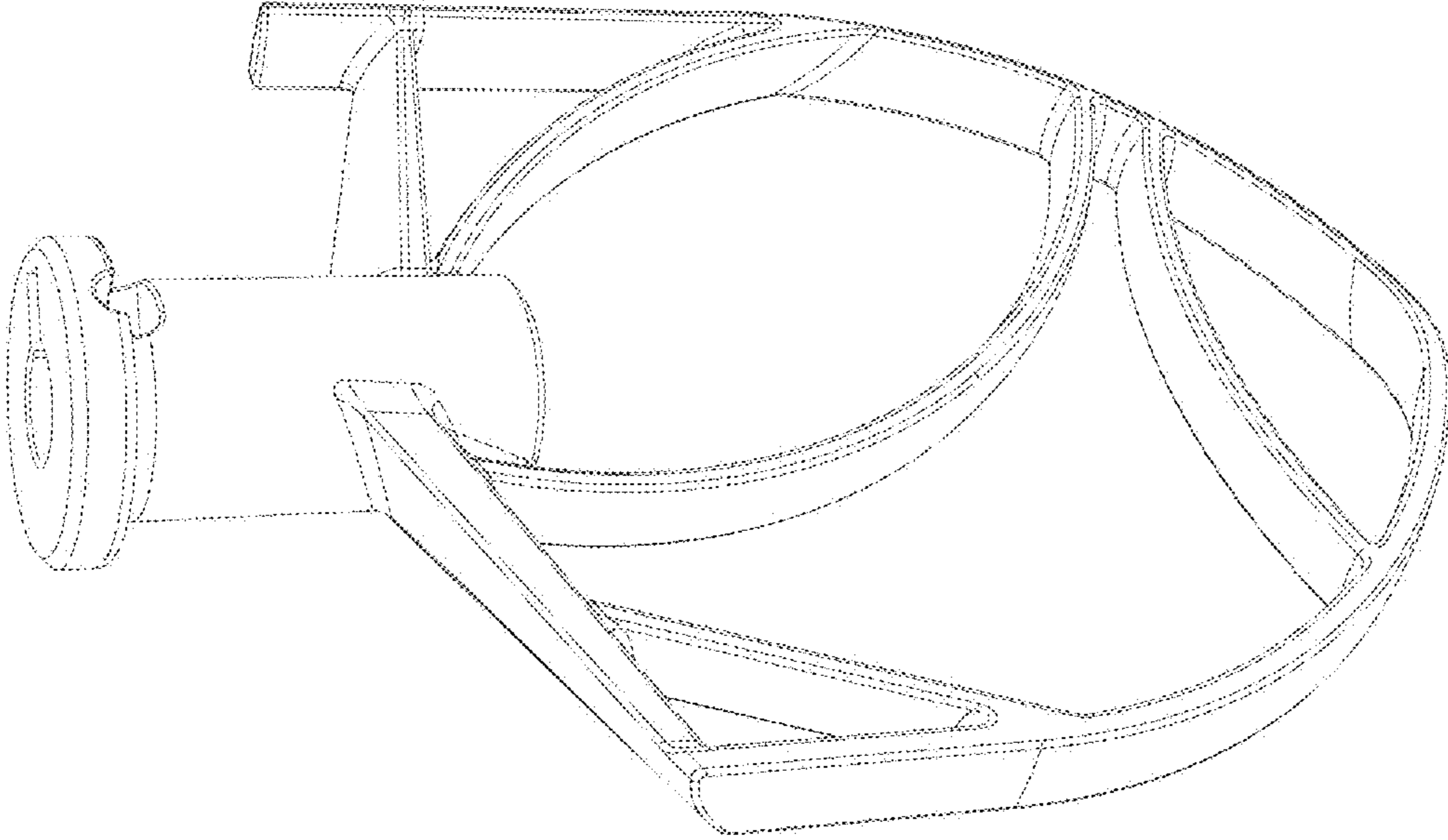

FIG. 1

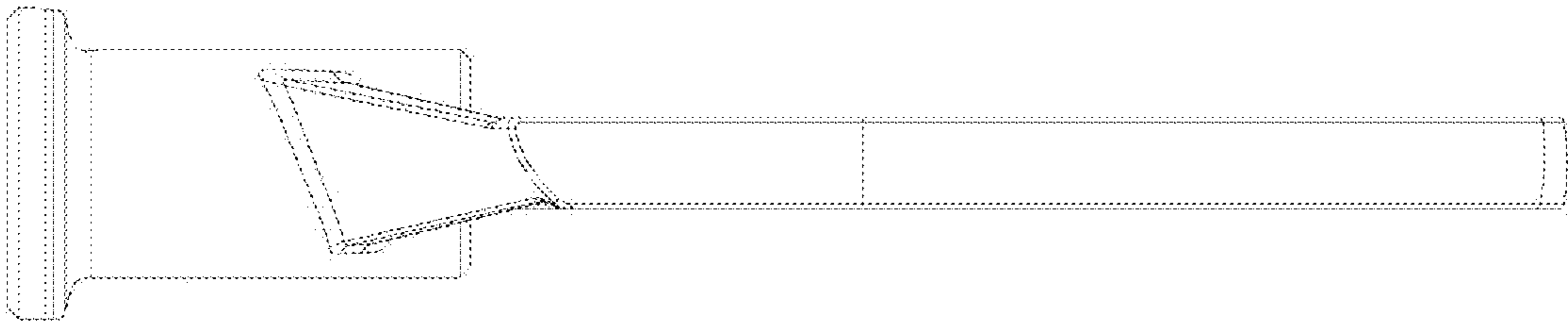

FIG. 2

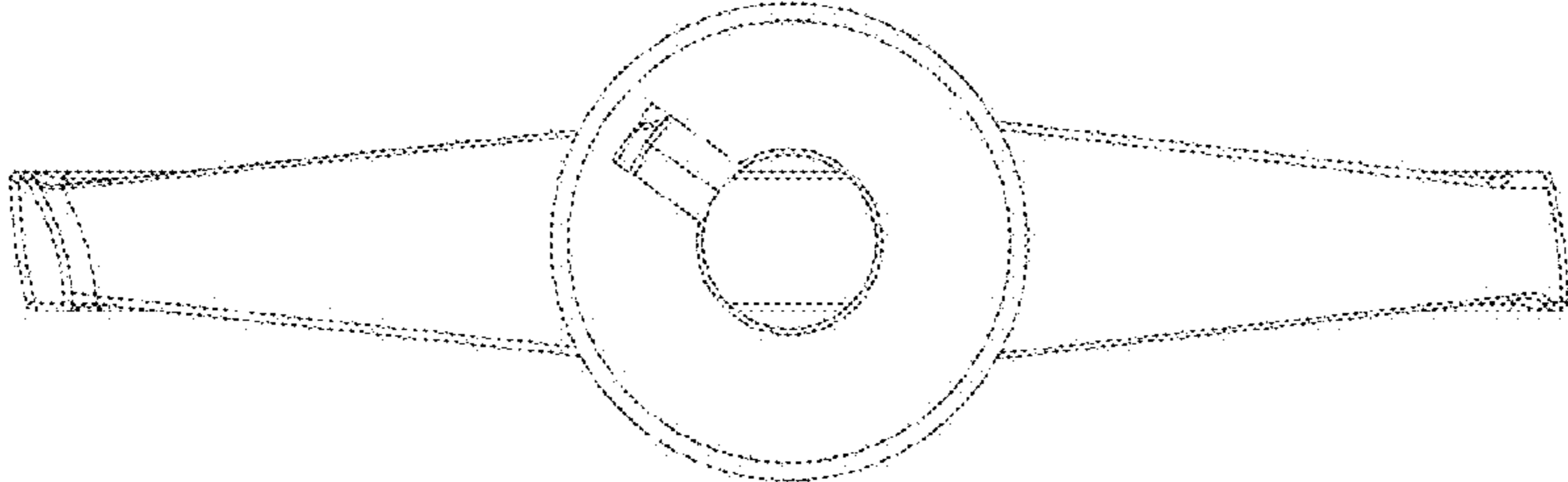

FIG. 3

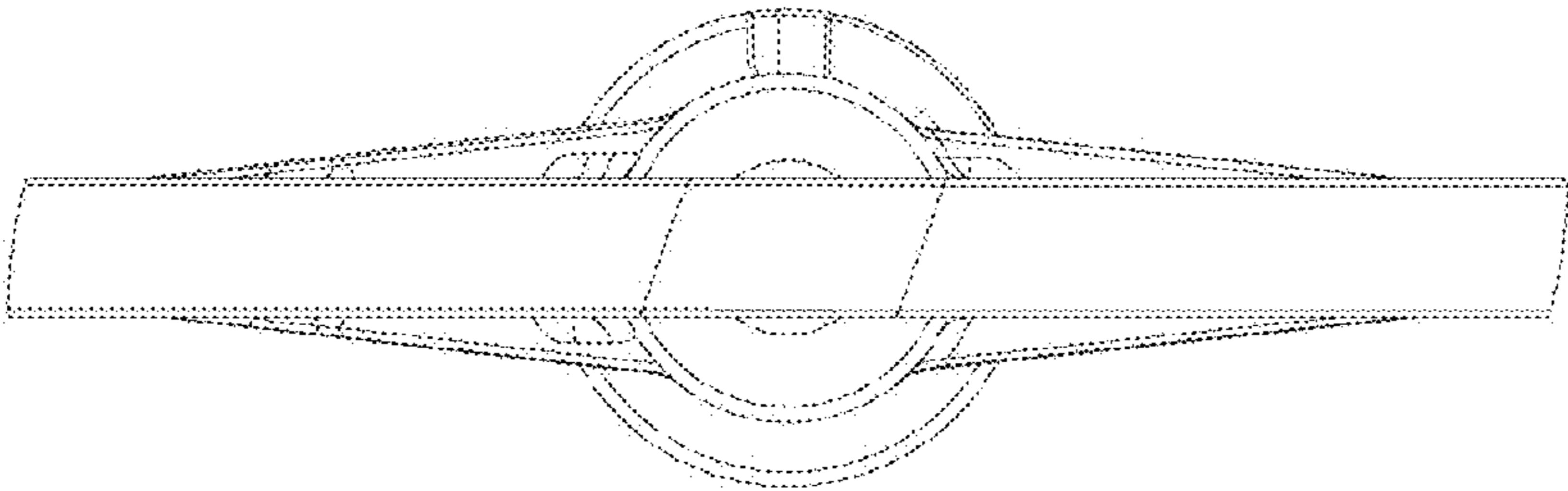

FIG. 4

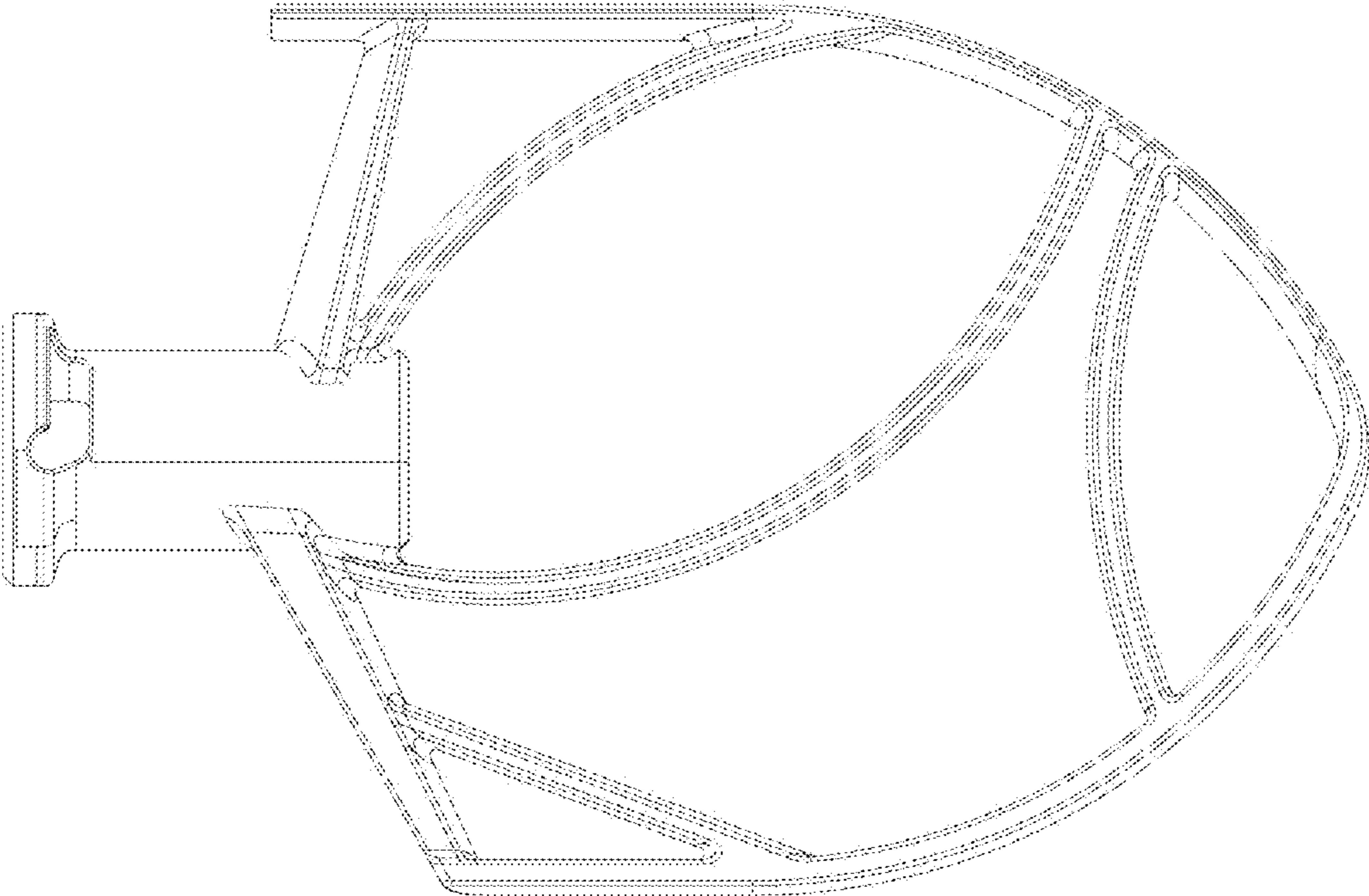

FIG. 5

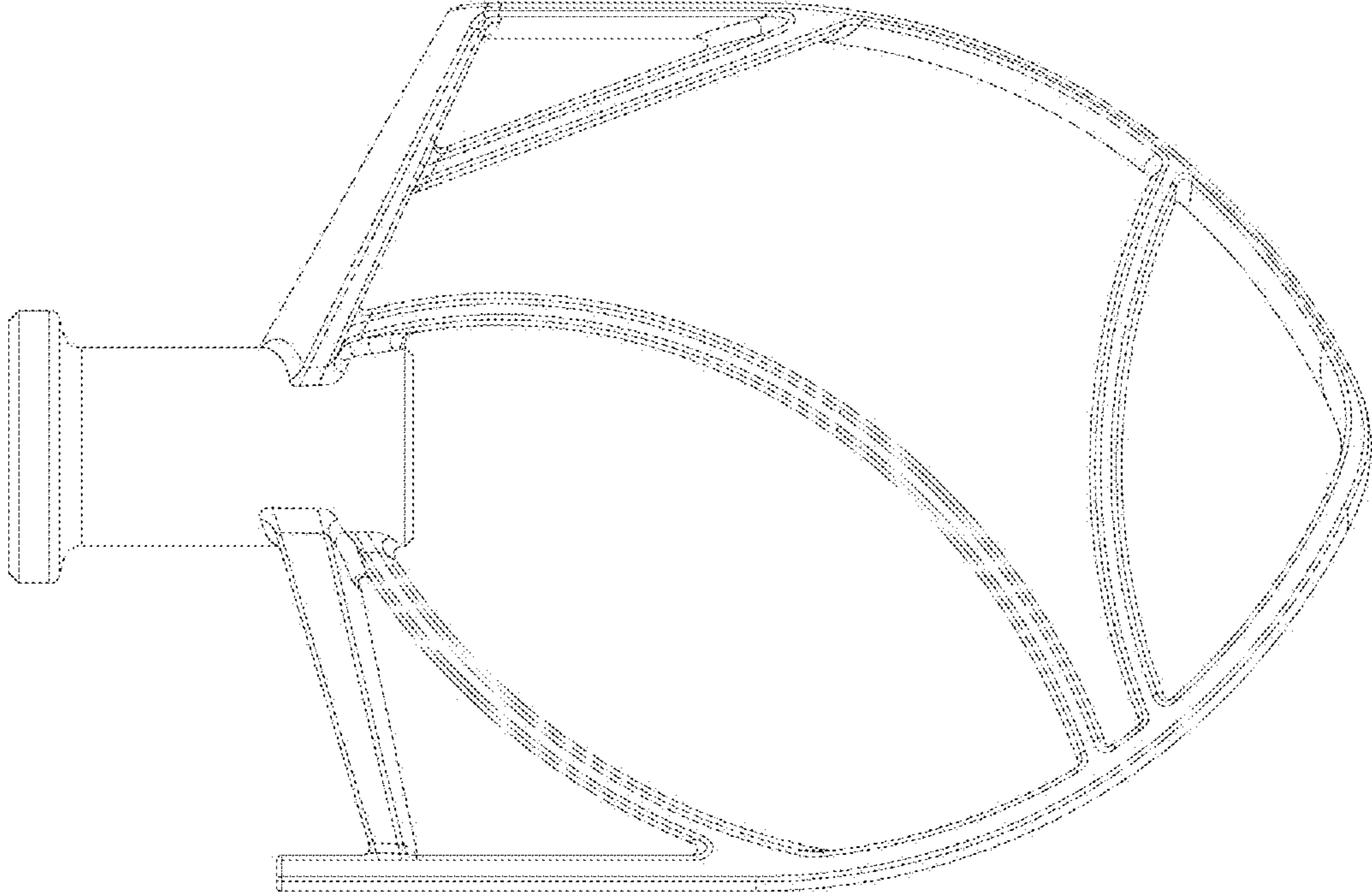

FIG. 6

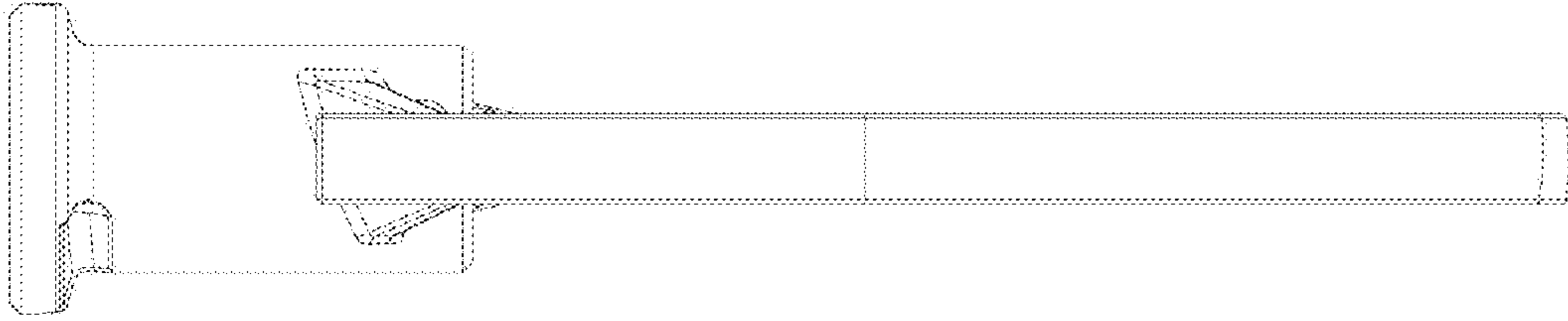

FIG. 7

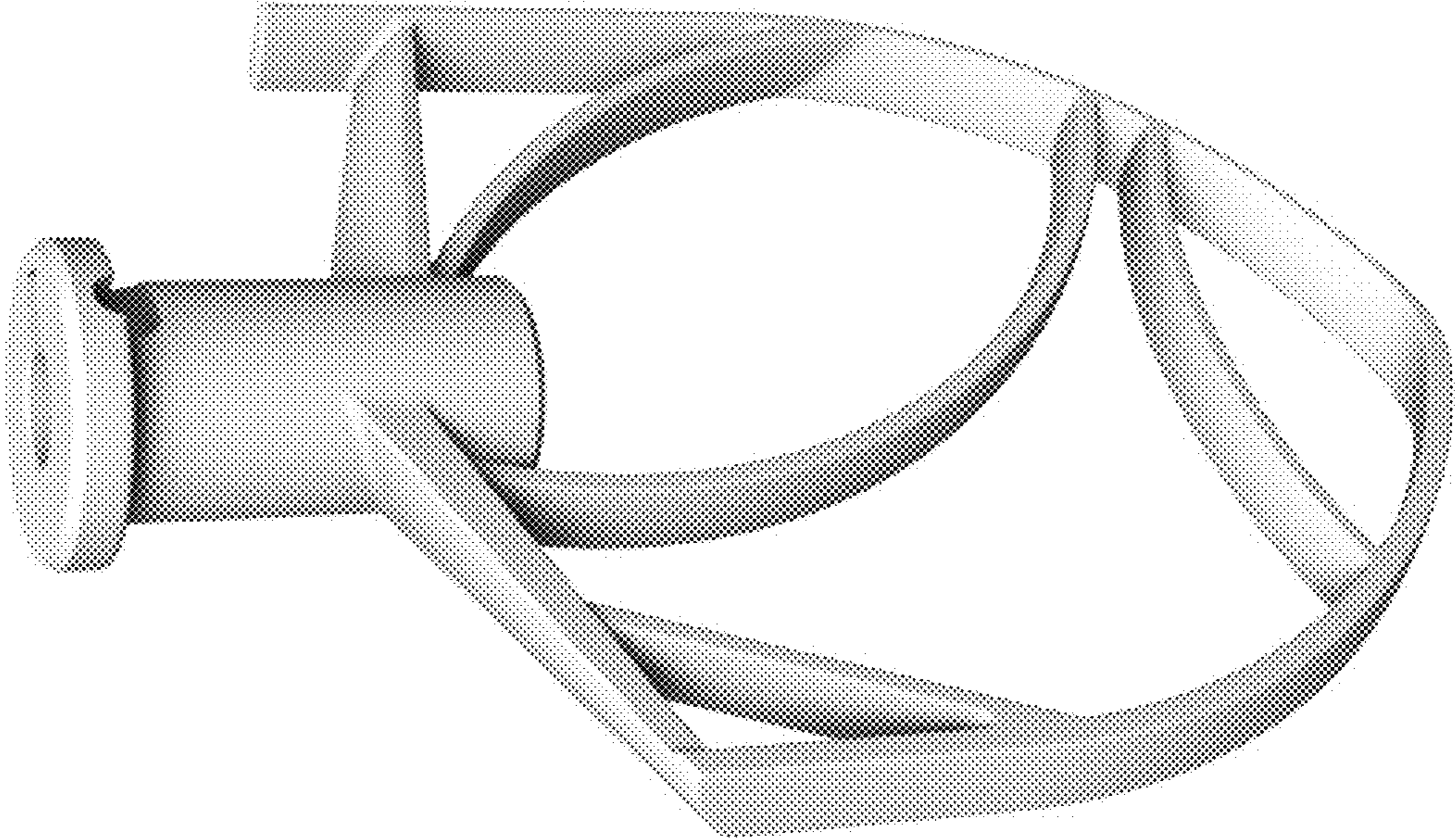

FIG. 8

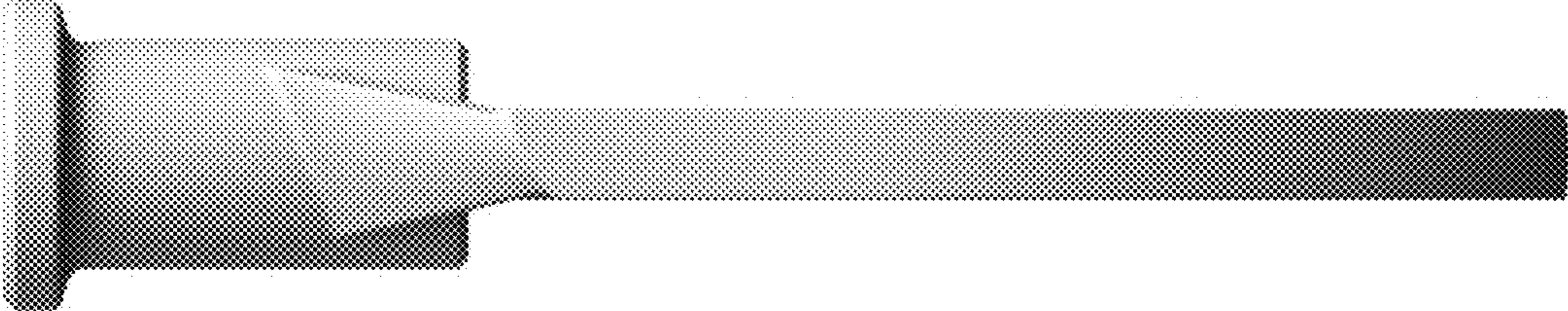

FIG. 9

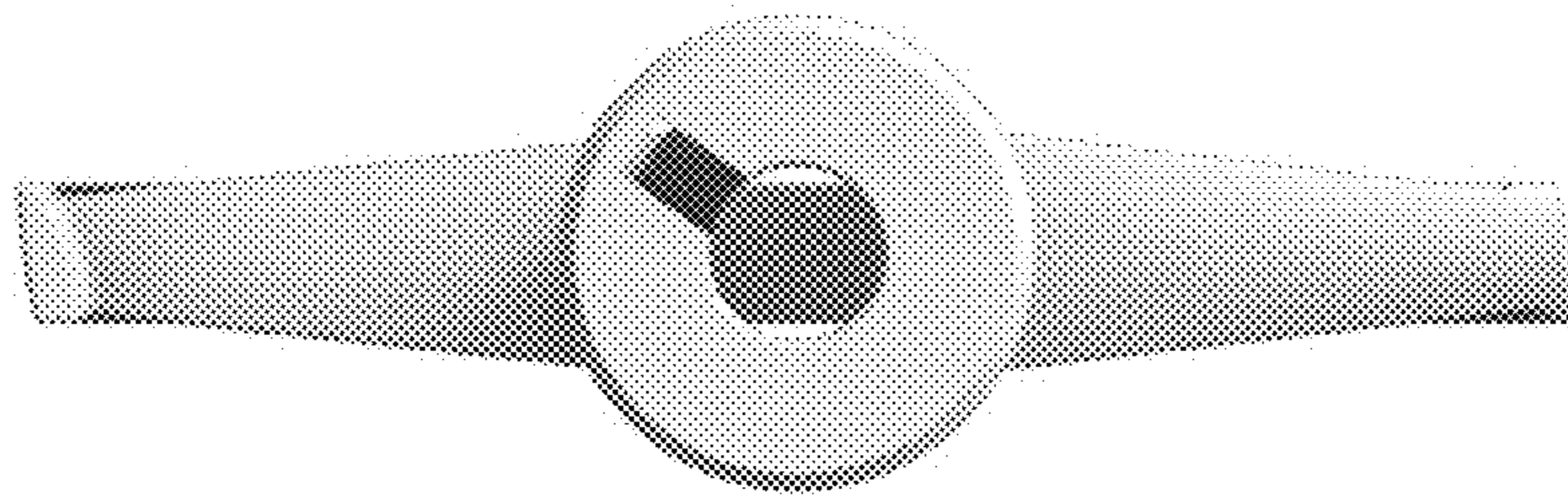

FIG. 10

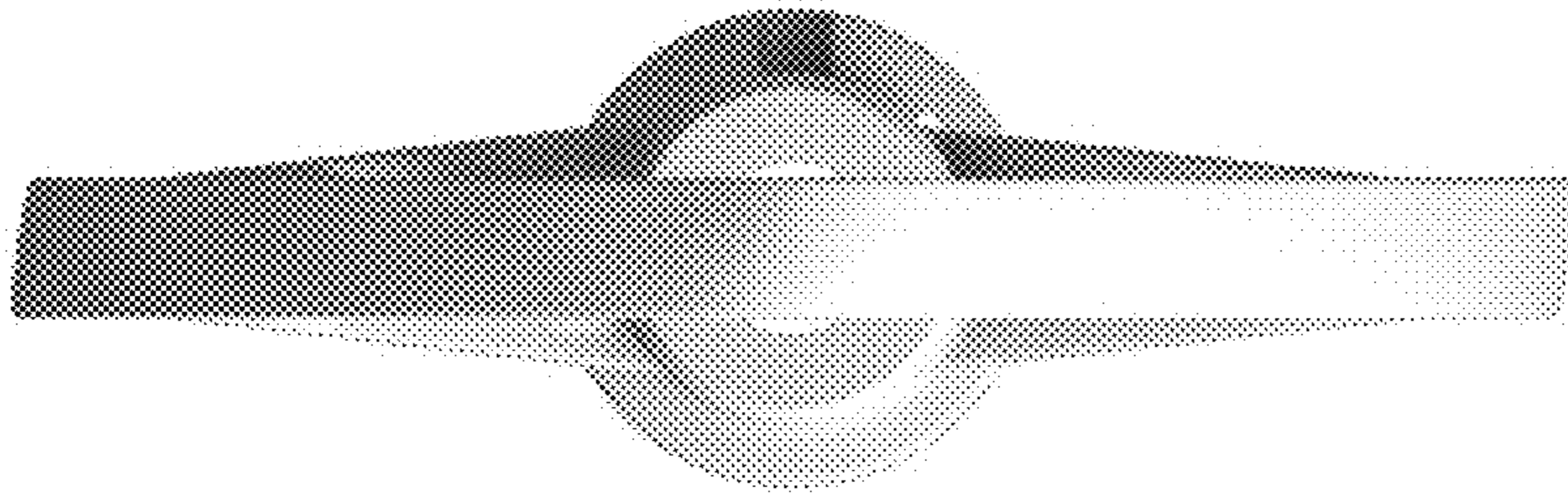

FIG. 11

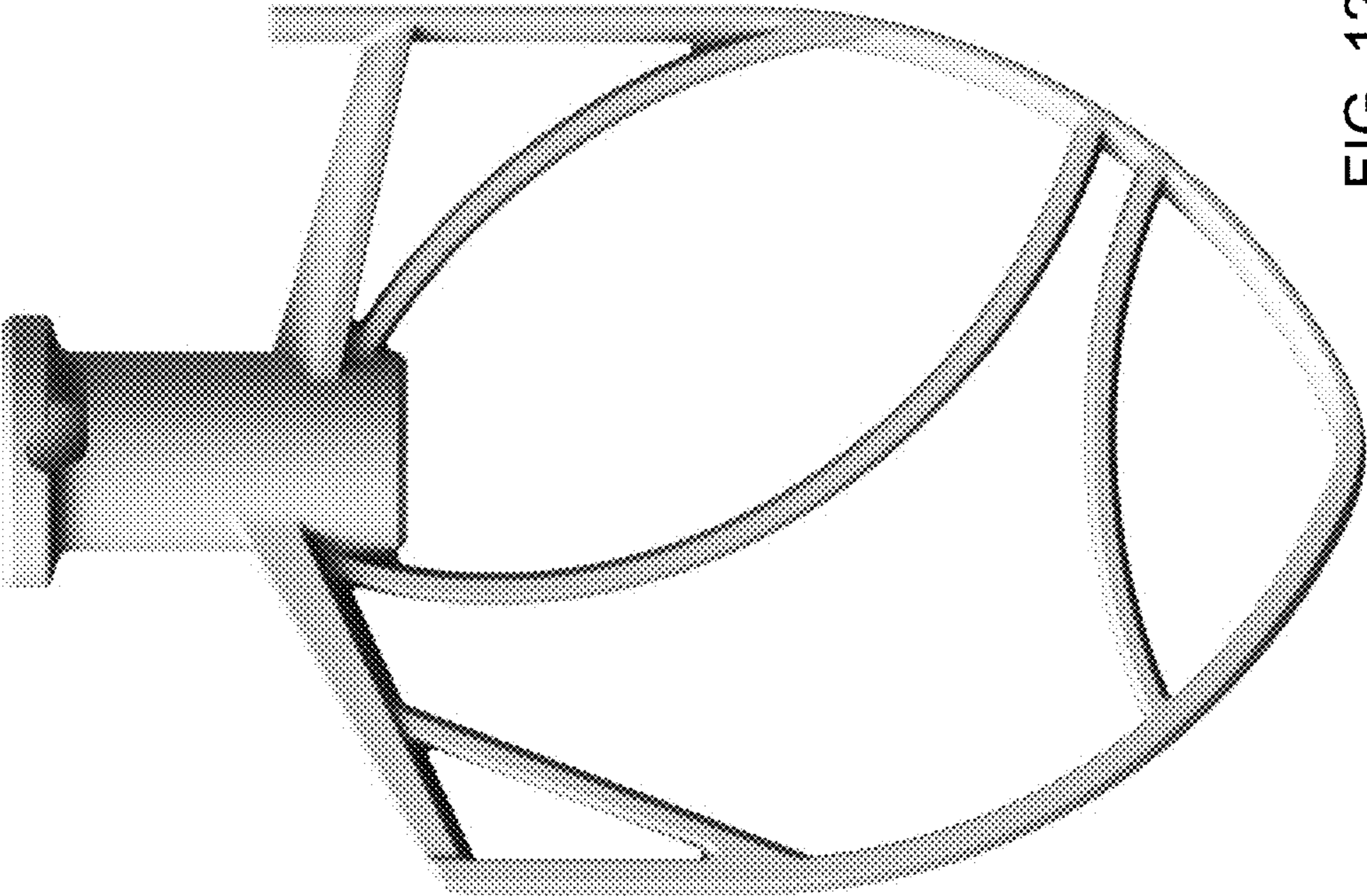

FIG. 12

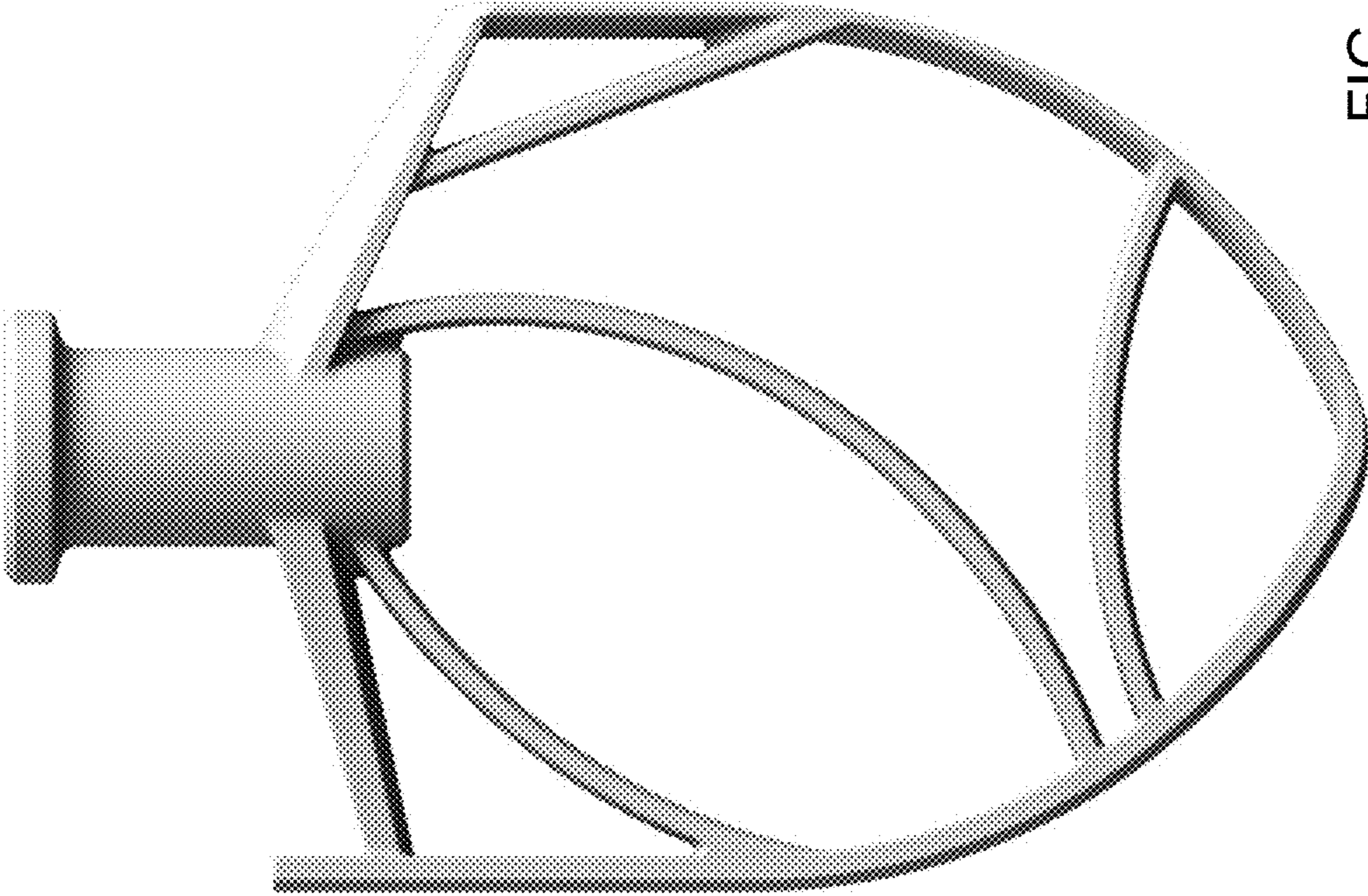

FIG. 13

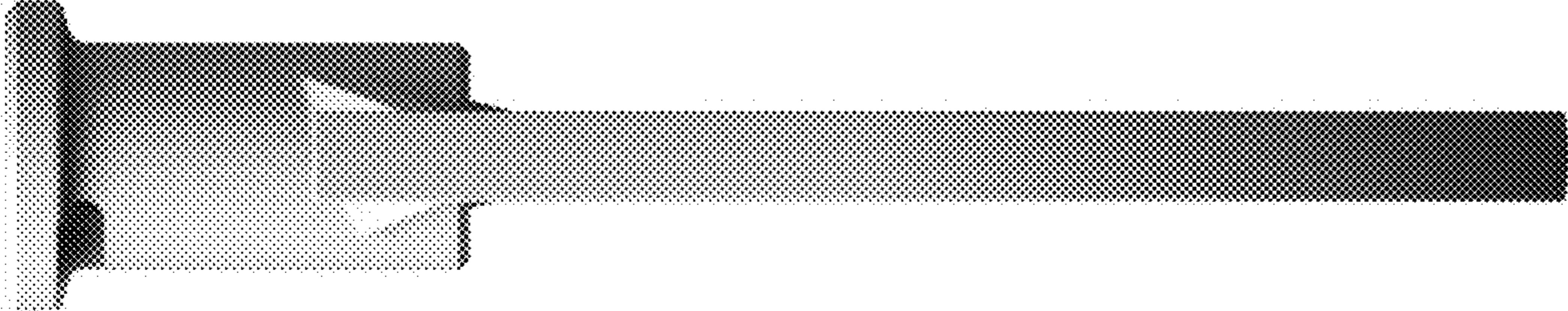

FIG. 14