



US00D684414S

(12) **United States Design Patent**
Tsuchiya

(10) **Patent No.:** **US D684,414 S**
(45) **Date of Patent:** **** Jun. 18, 2013**

(54) **TABLE**

(75) Inventor: **Waku Tsuchiya**, Kanagawa (JP)

(73) Assignee: **Okamura Corporation**, Kanagawa (JP)

(**) Term: **14 Years**

(21) Appl. No.: **29/415,390**

(22) Filed: **Mar. 9, 2012**

(30) **Foreign Application Priority Data**

Sep. 12, 2011 (JP) 2011-020721

(51) **LOC (9) Cl.** **06-06**

(52) **U.S. Cl.**
USPC **D6/709**

(58) **Field of Classification Search**

USPC D6/480-489, 495-499, 429, 422,
D6/425, 426, 492, 494; 108/153.1, 155, 156,
108/157.1, 161, 50.01, 50.02, 176; 248/188,
248/188.1, 188.8, 423, 188.5

See application file for complete search history.

(56) **References Cited**

U.S. PATENT DOCUMENTS

D216,715 S * 3/1970 Dotringer D6/495
D423,257 S * 4/2000 Paus D6/495
D431,398 S * 10/2000 Luong et al. D6/484

D433,849 S * 11/2000 Walters et al. D6/484
D498,949 S * 11/2004 Frenkler et al. D6/484
D659,442 S * 5/2012 Henriott et al. D6/495

* cited by examiner

Primary Examiner — Janice Seeger

(74) *Attorney, Agent, or Firm* — Sughrue Mion, PLLC

(57) **CLAIM**

The ornamental design for a table, as shown and described.

DESCRIPTION

FIG. 1 is a perspective view of a table.
FIG. 2 is a front elevation view thereof. A rear elevation view is a mirror image of the front elevation view.
FIG. 3 is a right side elevation view thereof.
FIG. 4 is a bottom plan view thereof.
FIG. 5 is a top plan view thereof.
FIG. 6 is a left side elevation view thereof.
FIG. 7 is an enlarged left side elevation view of the claimed portion only.
FIG. 8 is an enlarged end view thereof taken along the line 8-8 in FIG. 7.
FIG. 9 is an enlarged end view thereof taken along the line 9-9 in FIG. 7; and,
FIG. 10 is an enlarged end view thereof taken along the line 10-10 in FIG. 7.
The portions of the table shown in broken lines are for the purpose of showing environmental structure only and form no part of the claimed design.

1 Claim, 10 Drawing Sheets

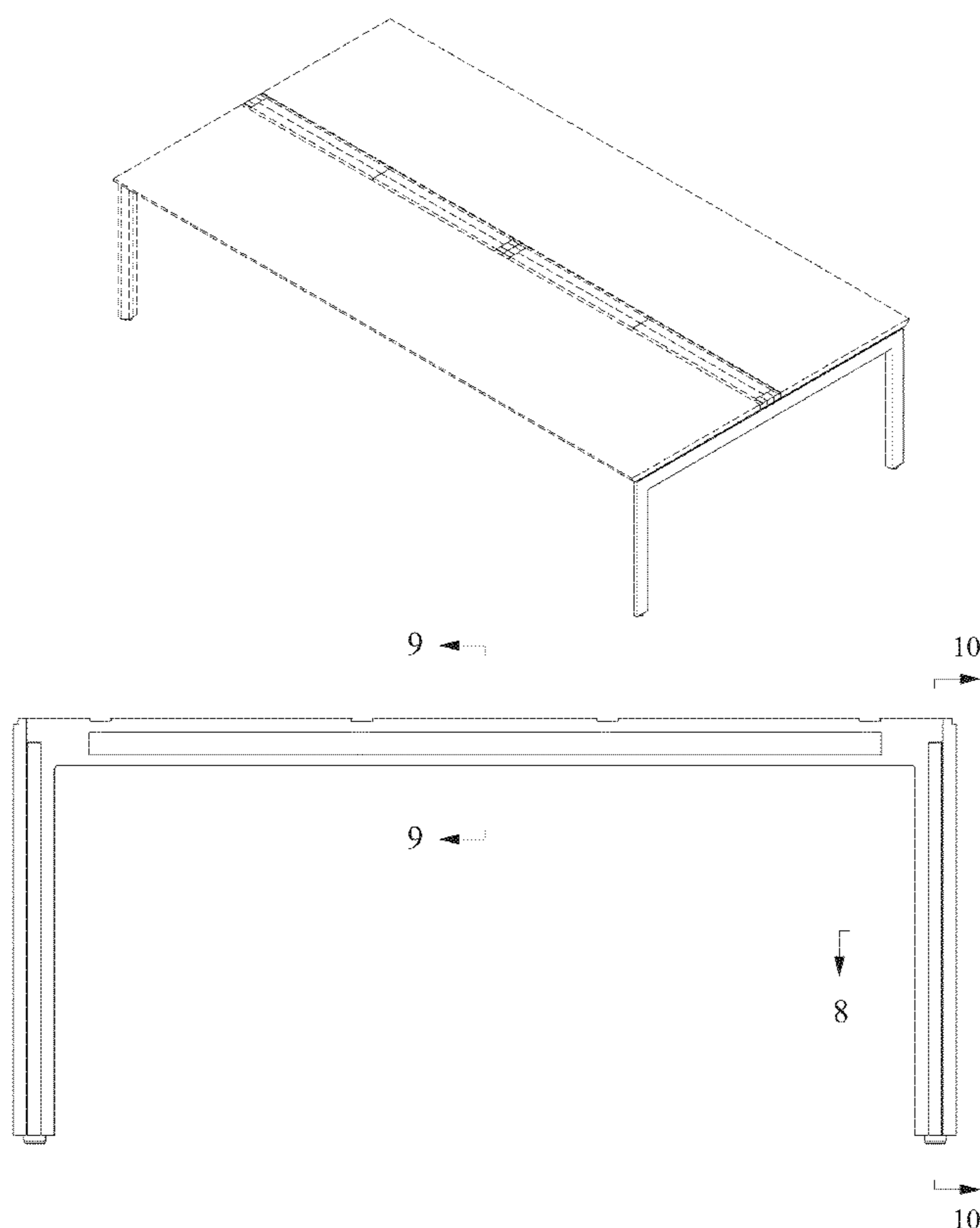

FIG. 1

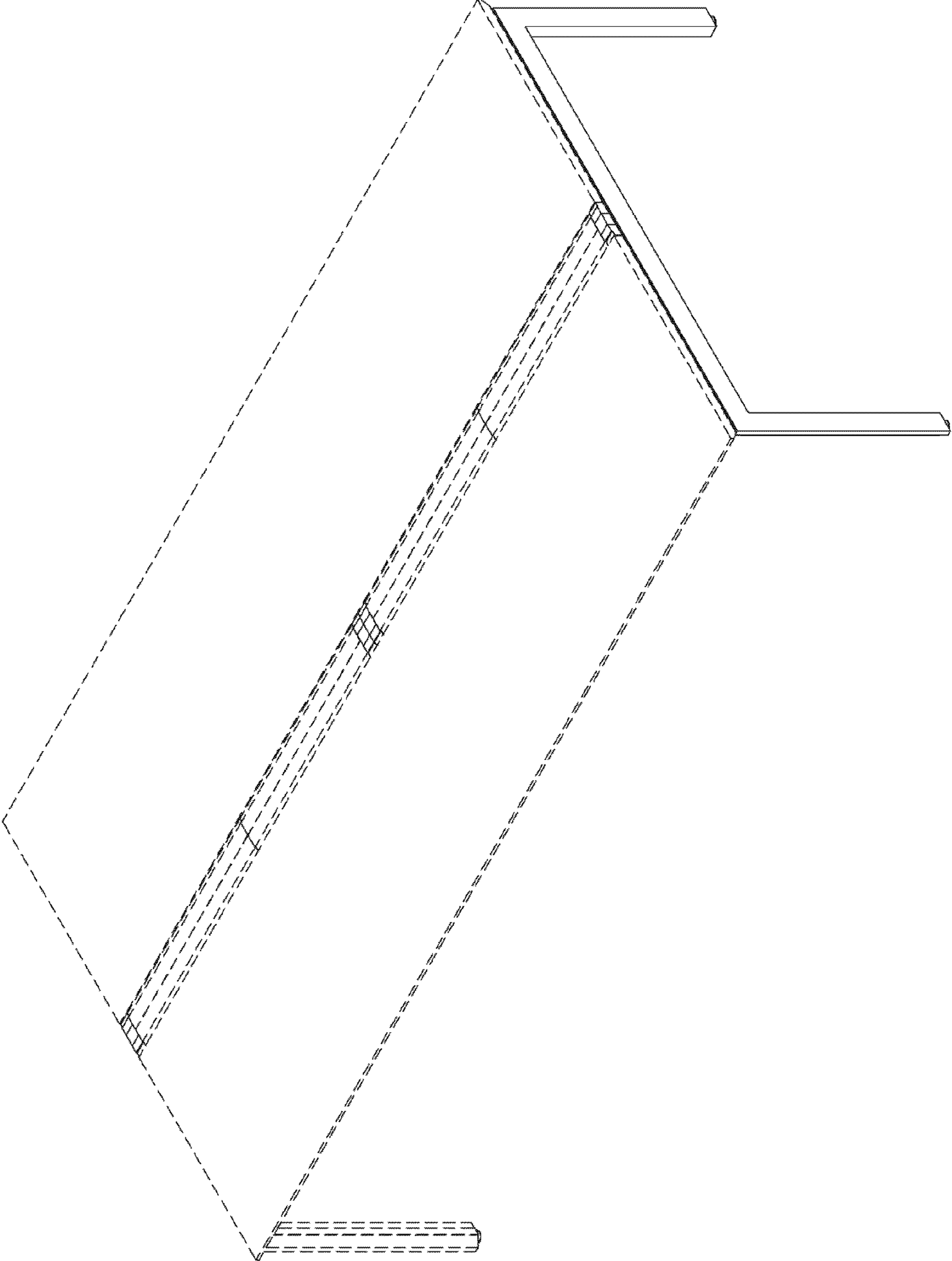

FIG. 2

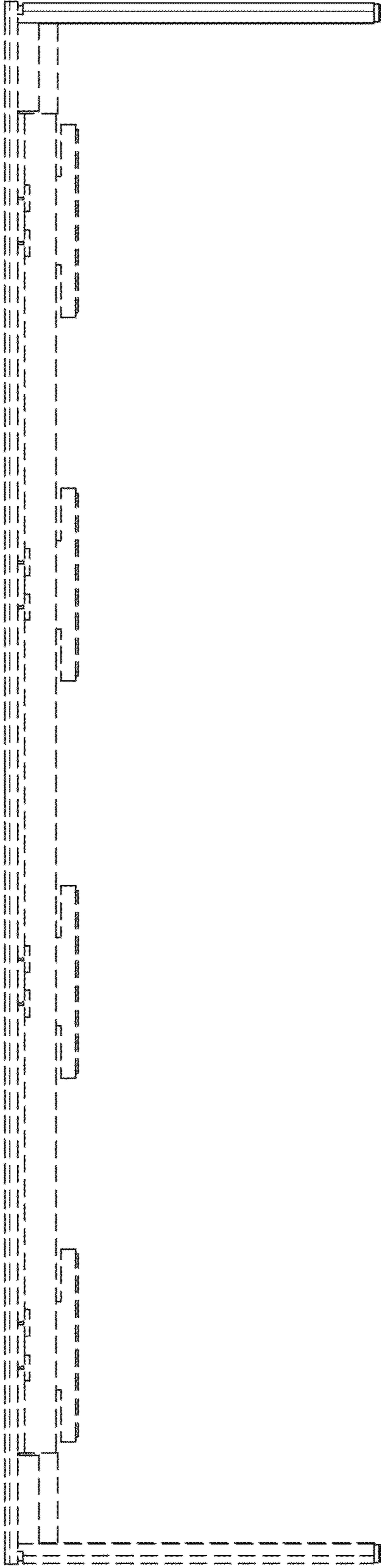

FIG. 3

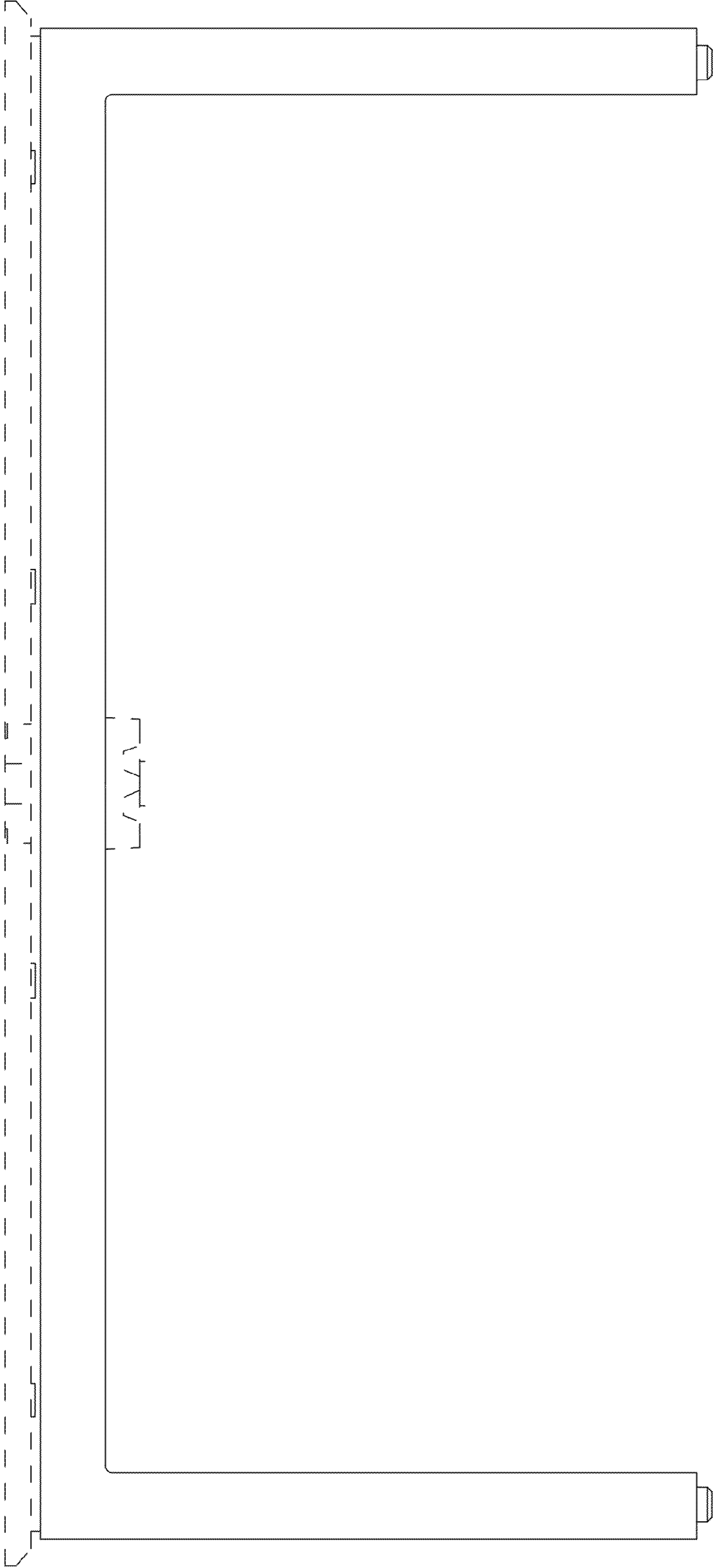

FIG. 4

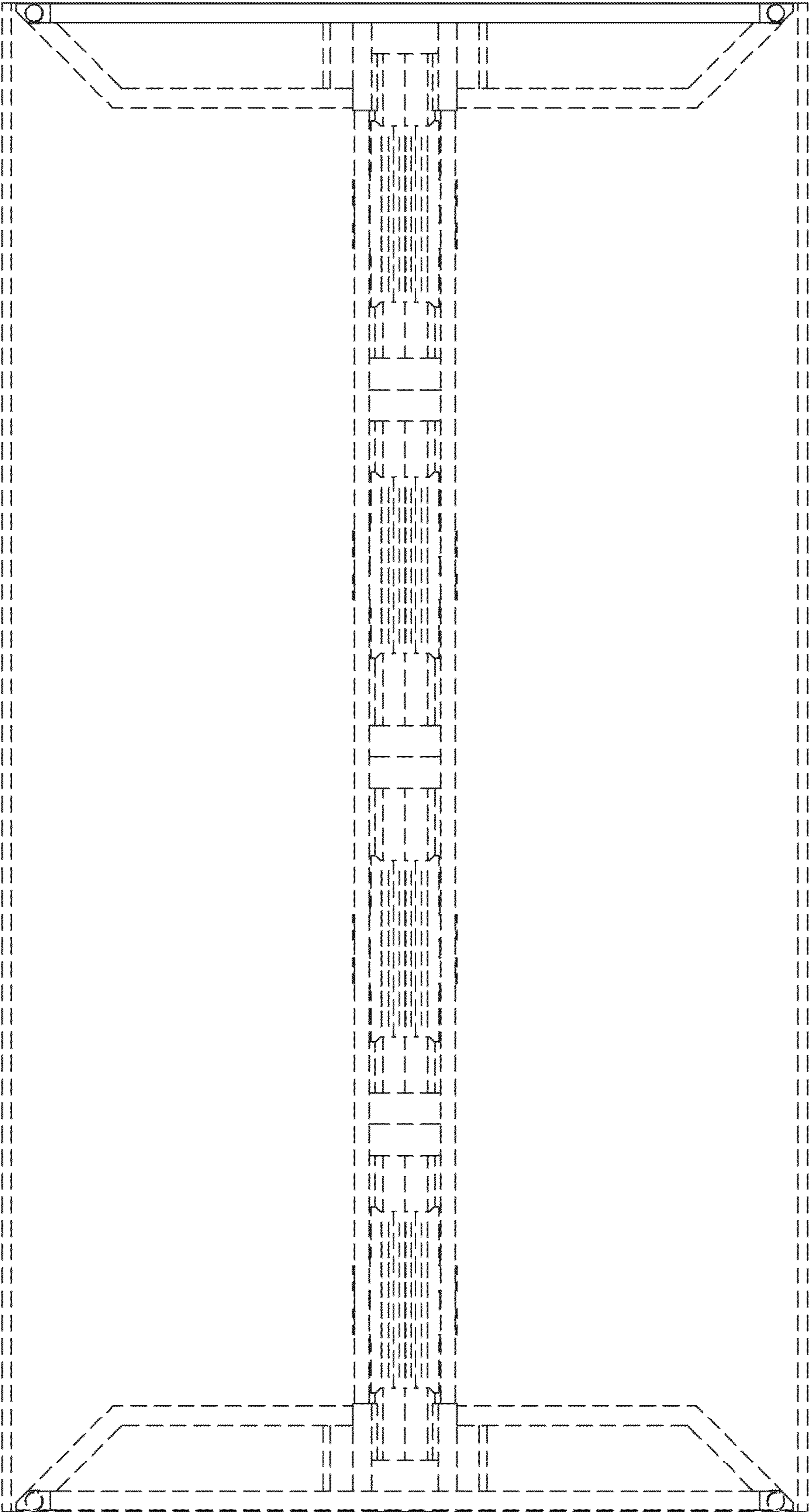

FIG. 5

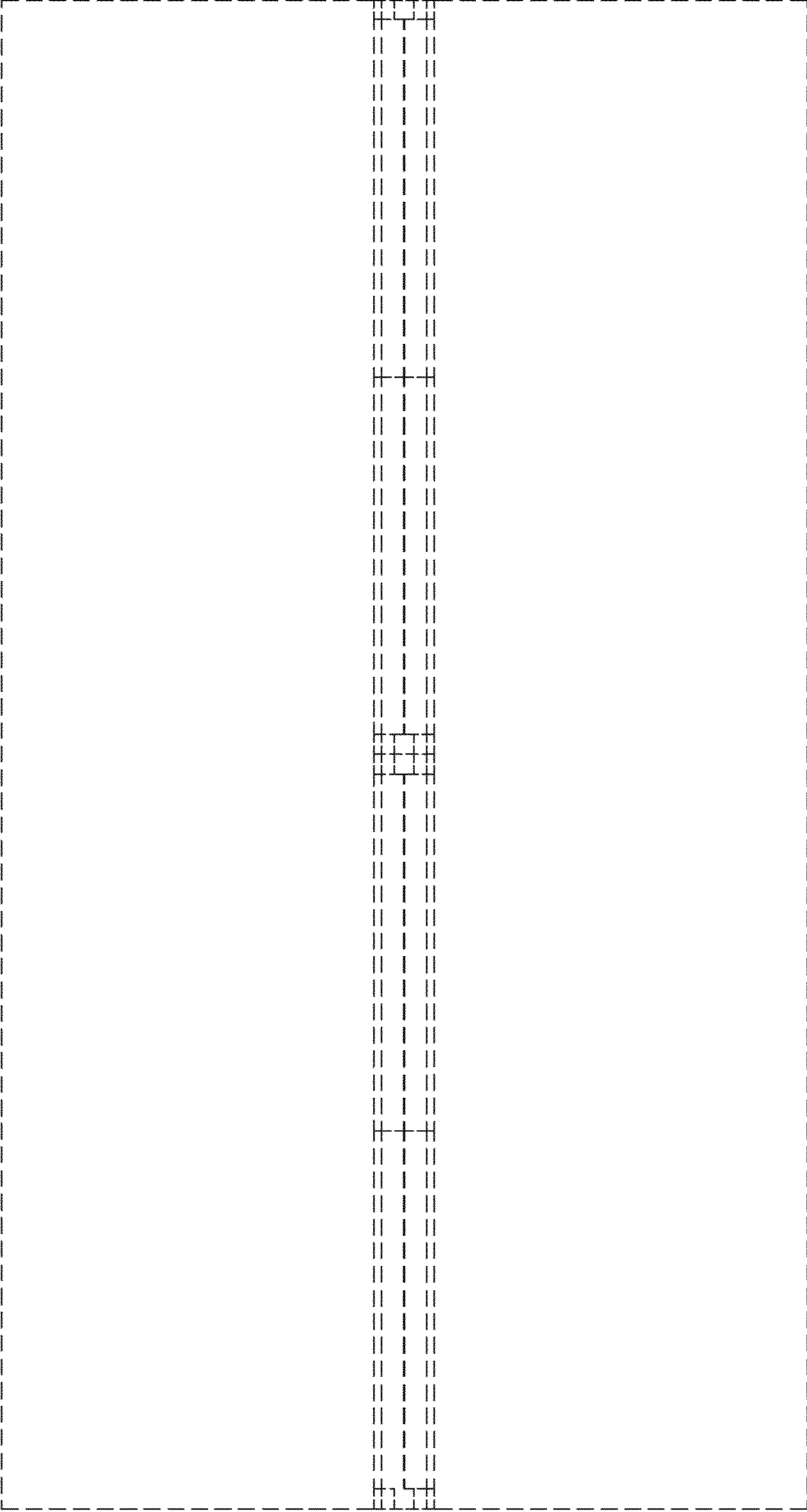

FIG. 6

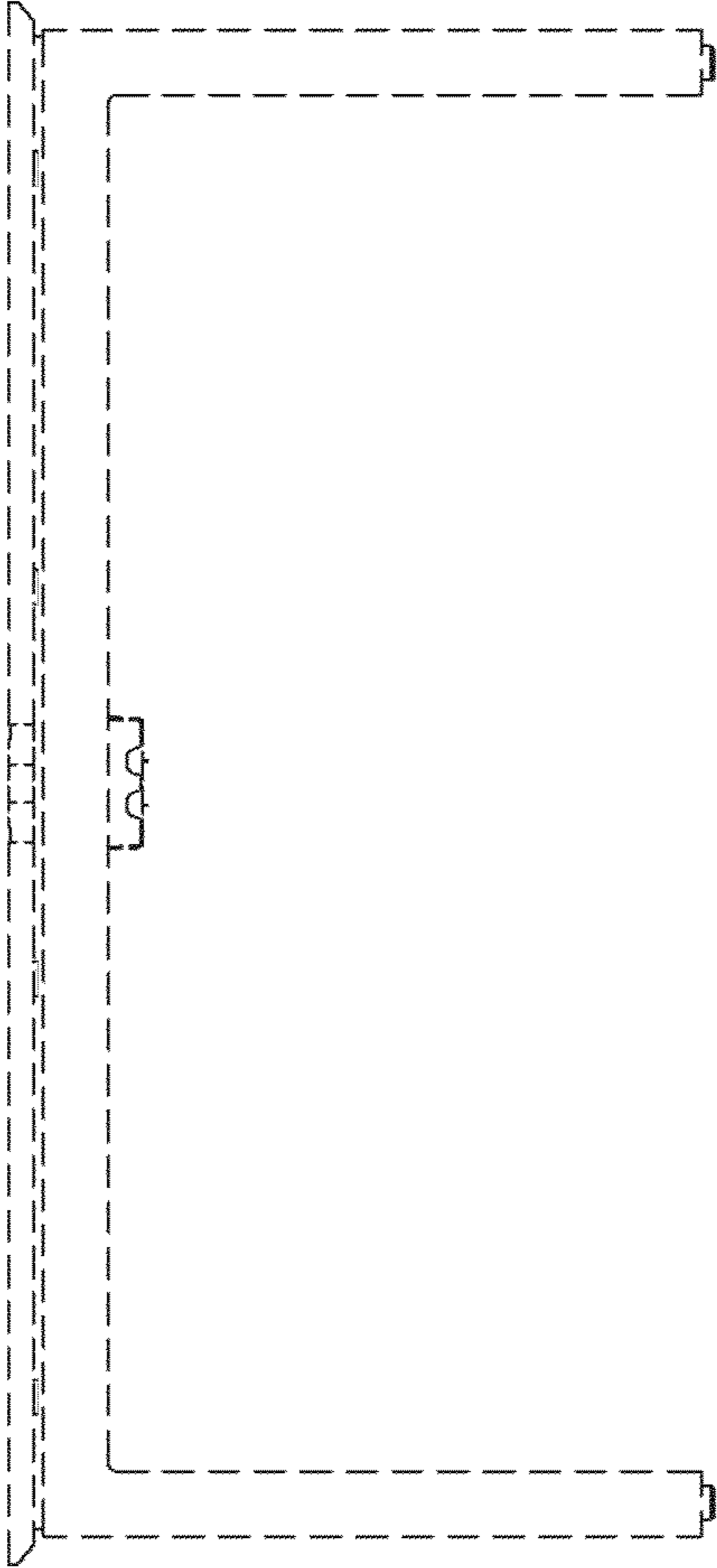

FIG. 7

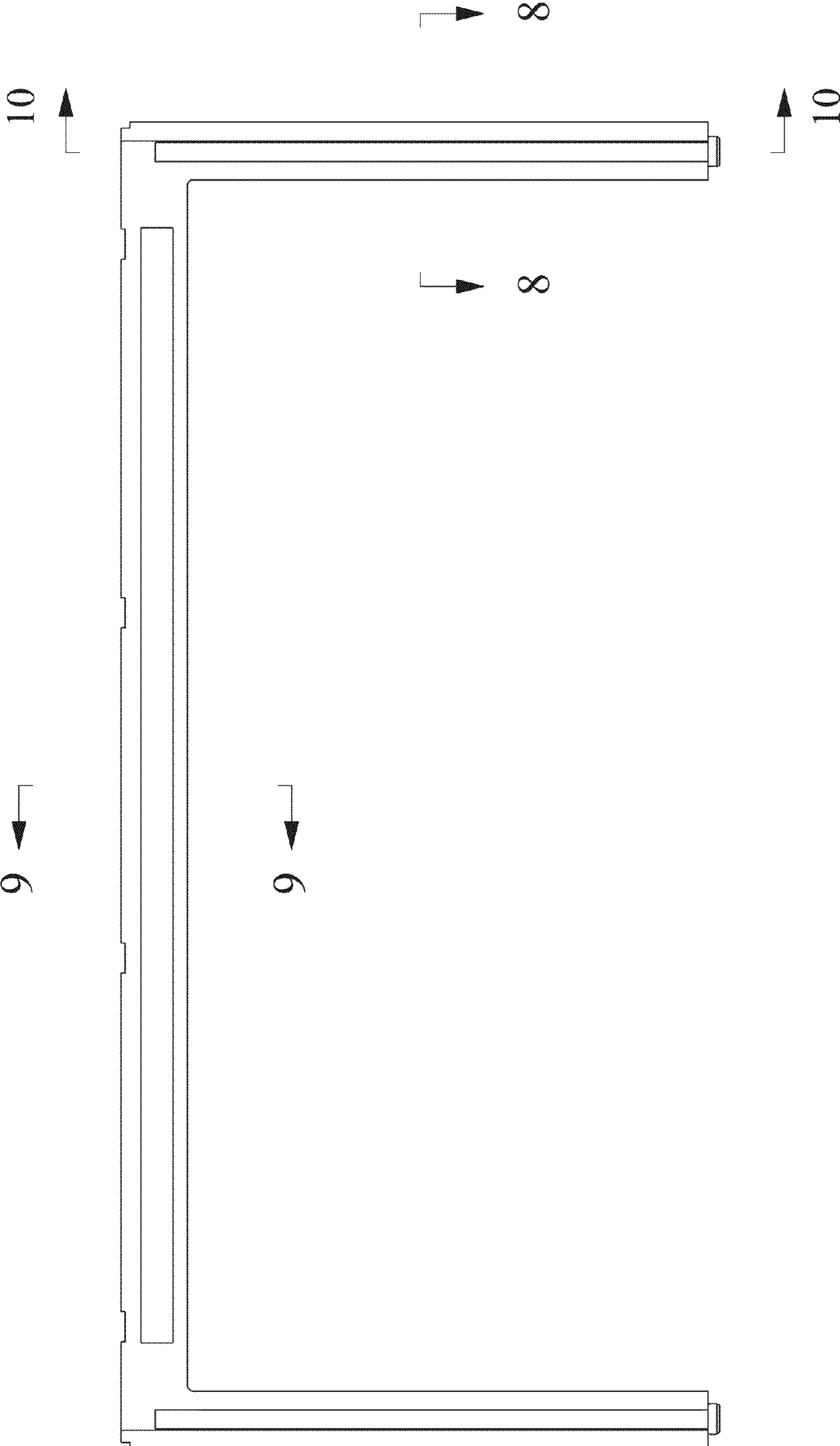

FIG. 8

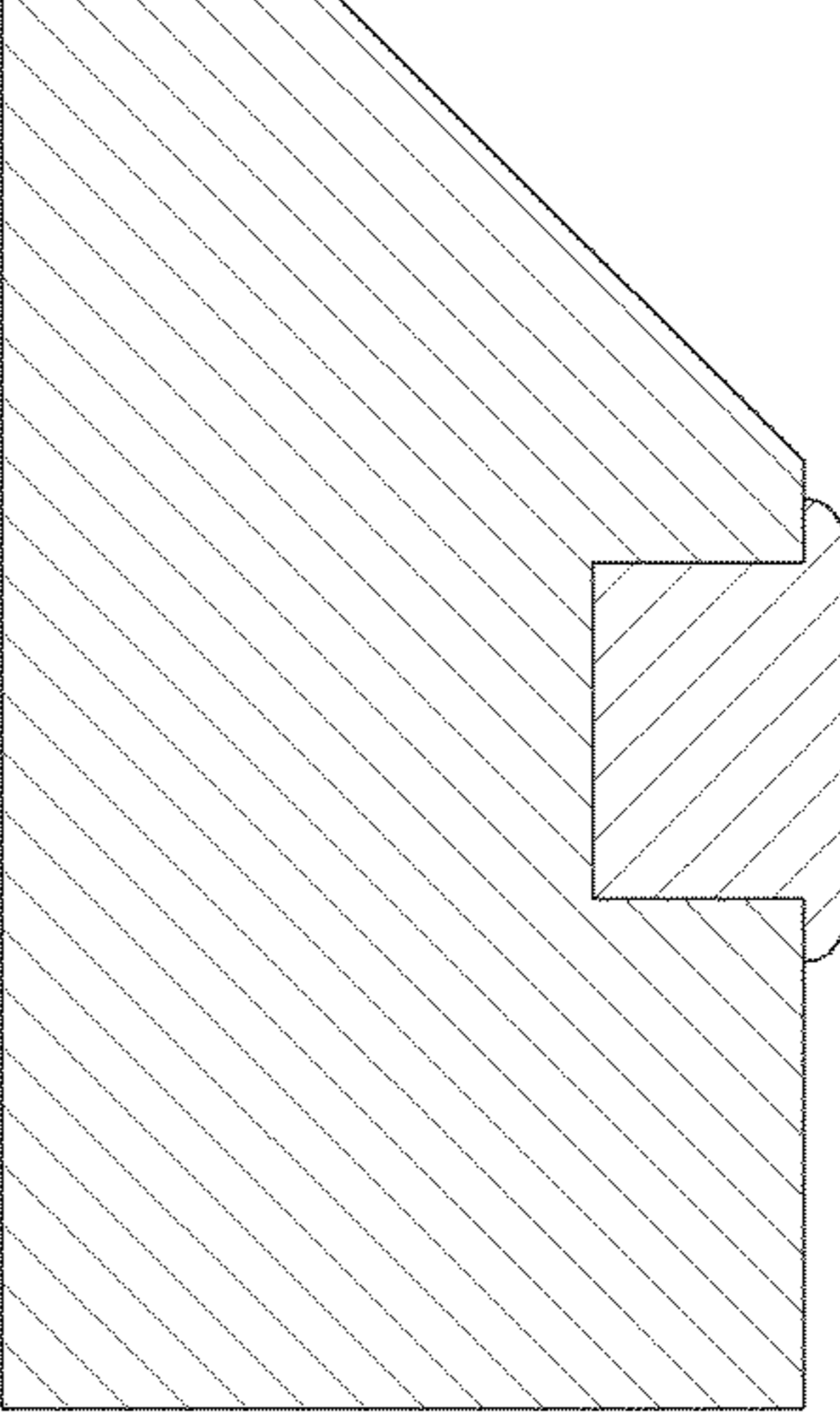

FIG. 9

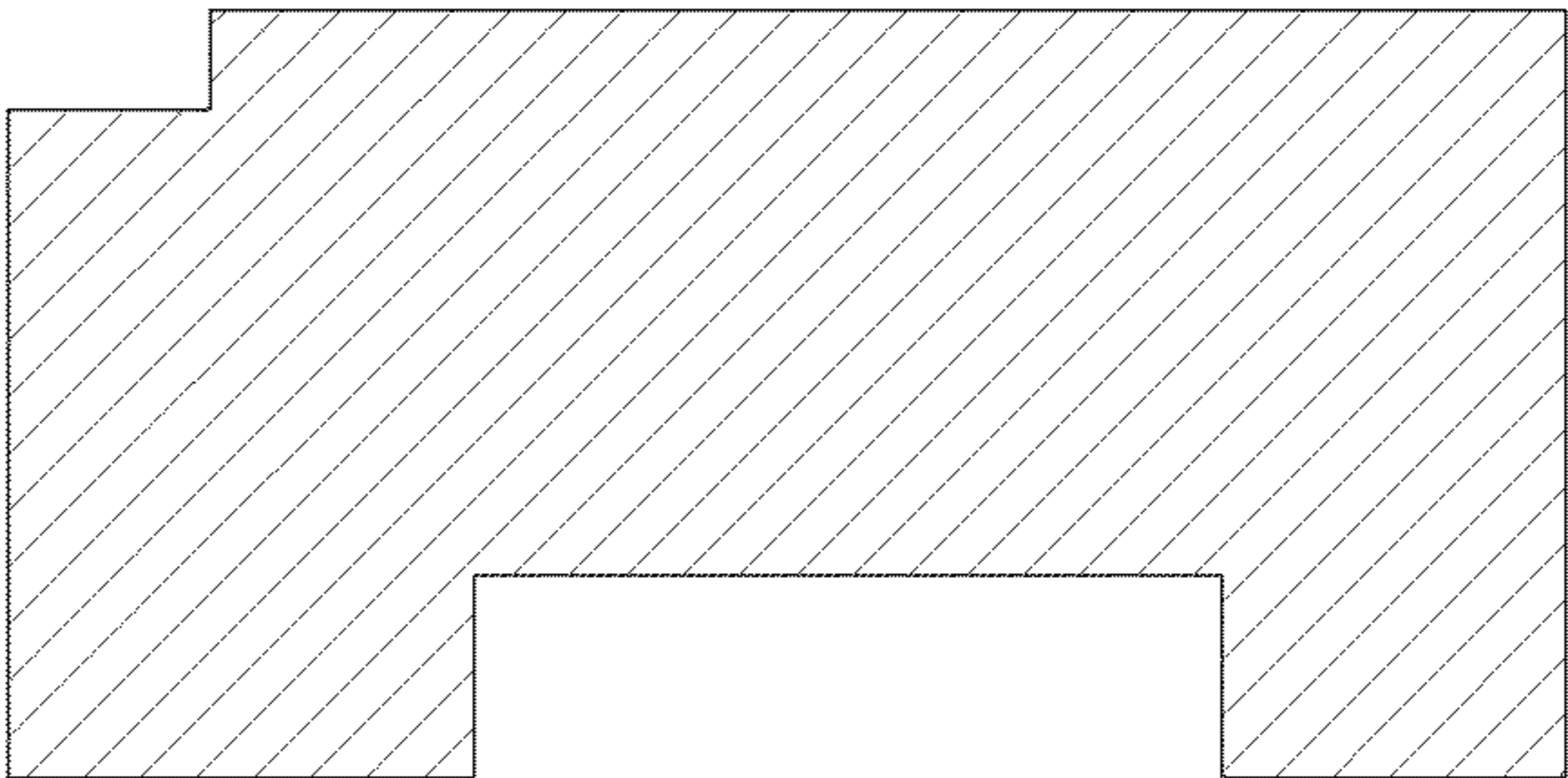

FIG. 10

