



US00D684382S

(12) **United States Design Patent**
Chan

(10) **Patent No.:** **US D684,382 S**

(45) **Date of Patent:** **** Jun. 18, 2013**

(54) **TOP SIZER**

(75) **Inventor:** **King Keung Kennedy Chan**, Hong Kong (HK)

(73) **Assignee:** **Uniplast Industries, Inc.**, Hasbrouck Heights, NJ (US)

(**) **Term:** **14 Years**

(21) **Appl. No.:** **29/411,842**

(22) **Filed:** **Jan. 26, 2012**

(51) **LOC (9) Cl.** **06-08**

(52) **U.S. Cl.**
USPC **D6/328**

(58) **Field of Classification Search**
USPC D6/315-328; 223/85-98; 211/1, 211/13.1, 85.3, 86.01, 105.2, 106.1, 123, 211/124, 183; 248/317, 339; 40/322
See application file for complete search history.

(56) **References Cited**

U.S. PATENT DOCUMENTS

5,503,310	A *	4/1996	Zuckerman et al.	223/85
D377,717	S *	2/1997	Gouldson	D6/328
5,603,437	A *	2/1997	Zuckerman	223/85
5,628,132	A *	5/1997	Marshall et al.	40/322
5,775,553	A *	7/1998	Marshall et al.	223/85
5,794,363	A *	8/1998	Marshall et al.	40/322
5,857,276	A *	1/1999	Marshall et al.	40/322
D410,793	S *	6/1999	Gouldson	D6/315

D449,744	S *	10/2001	Zuckerman	D6/328
6,523,240	B1 *	2/2003	Gouldson	29/403.1
6,726,067	B2 *	4/2004	Louw	223/85
D502,651	S *	3/2005	Gouldson	D10/46
7,178,705	B1 *	2/2007	Sutton	223/85
7,641,083	B2 *	1/2010	Goldman et al.	223/85
7,841,495	B2 *	11/2010	Gouldson	223/85
2002/0184799	A1 *	12/2002	Chou	40/322
2006/0049222	A1 *	3/2006	Pluchino et al.	223/85

* cited by examiner

Primary Examiner — Derrick Holland

Assistant Examiner — Lauren Calve

(74) *Attorney, Agent, or Firm* — Leason Ellis LLP

(57) **CLAIM**

The ornamental design for a top sizer, as shown and described.

DESCRIPTION

FIG. 1 is a top, front and side perspective view of a top sizer showing my new design;
FIG. 2 is a front elevation view thereof;
FIG. 3 is a top plan view thereof;
FIG. 4 is a rear elevation view thereof;
FIG. 5 is a bottom plan view thereof;
FIG. 6 is a right side view thereof; and,
FIG. 7 is a left side view thereof.

The broken line showing of a top sizer represents unclaimed subject matter and forms no part of the claimed design.

1 Claim, 2 Drawing Sheets

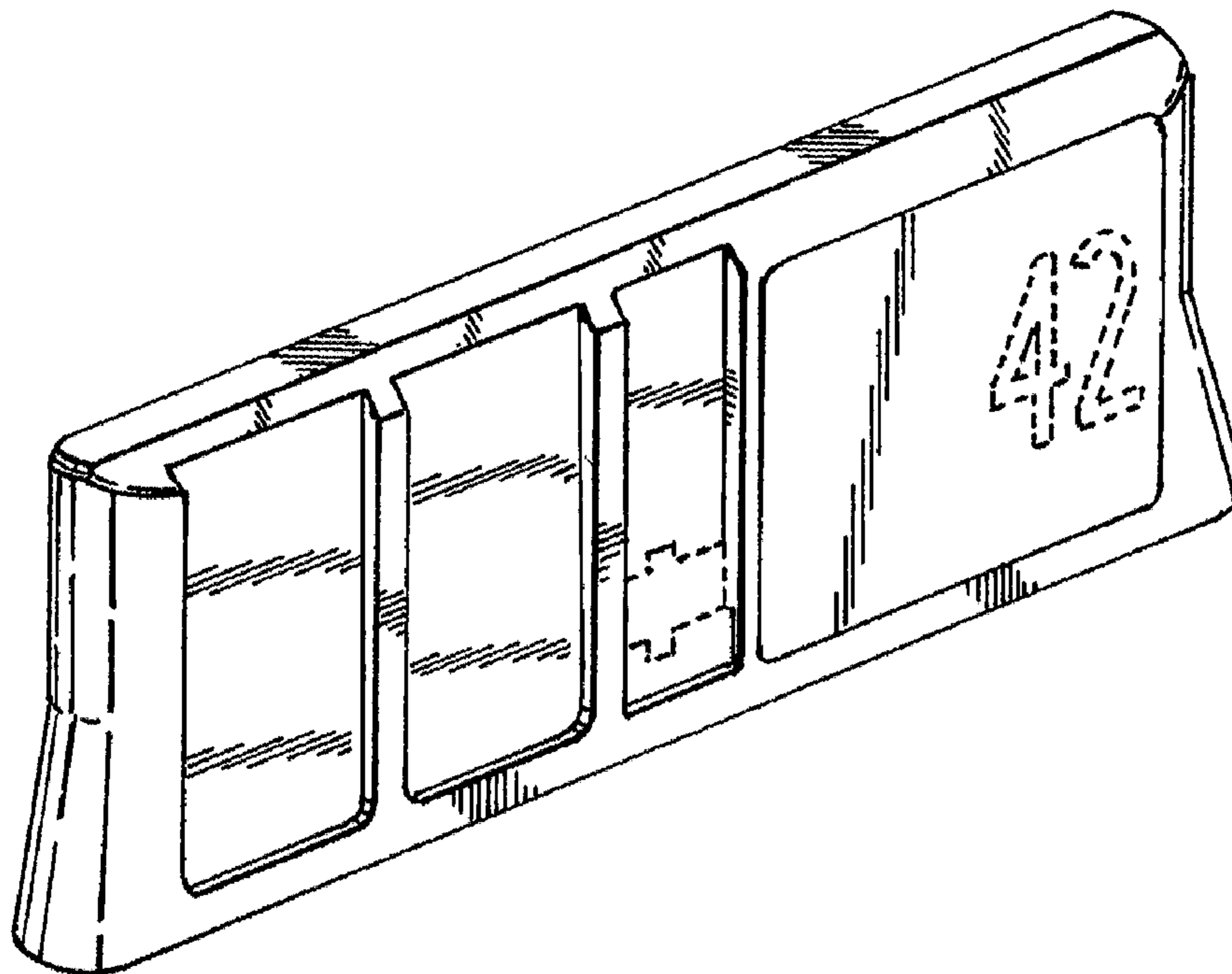

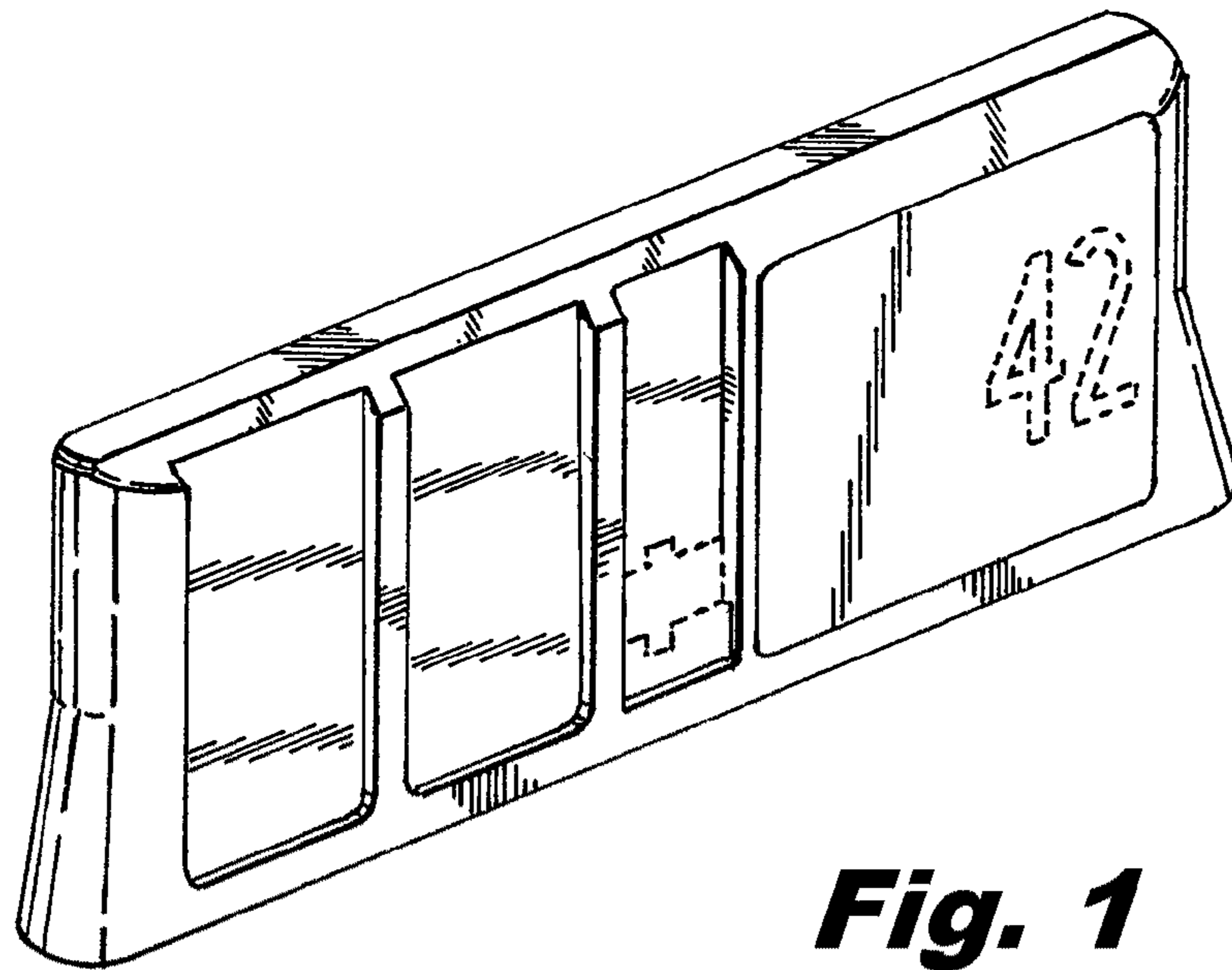

Fig. 1

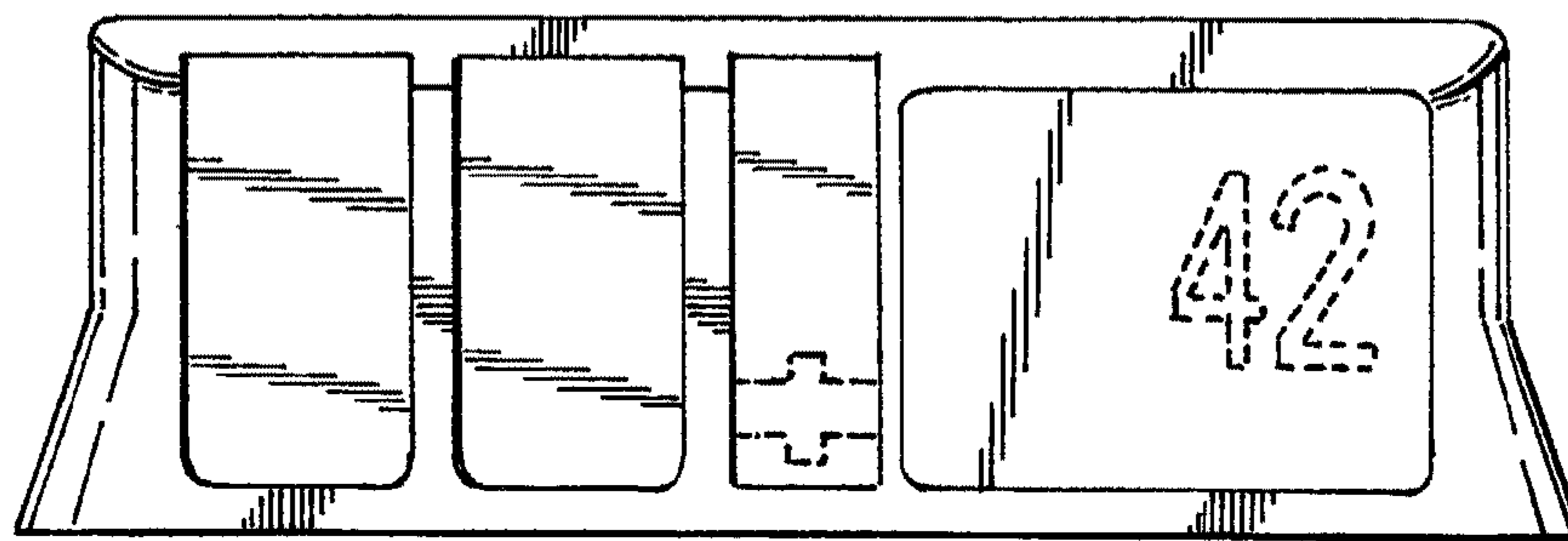

Fig. 2

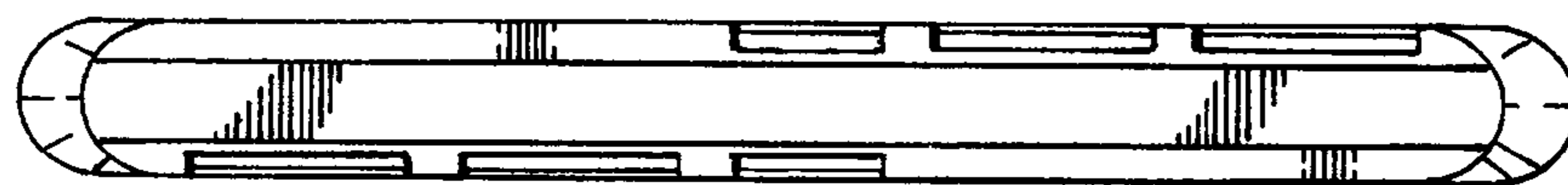

Fig. 3

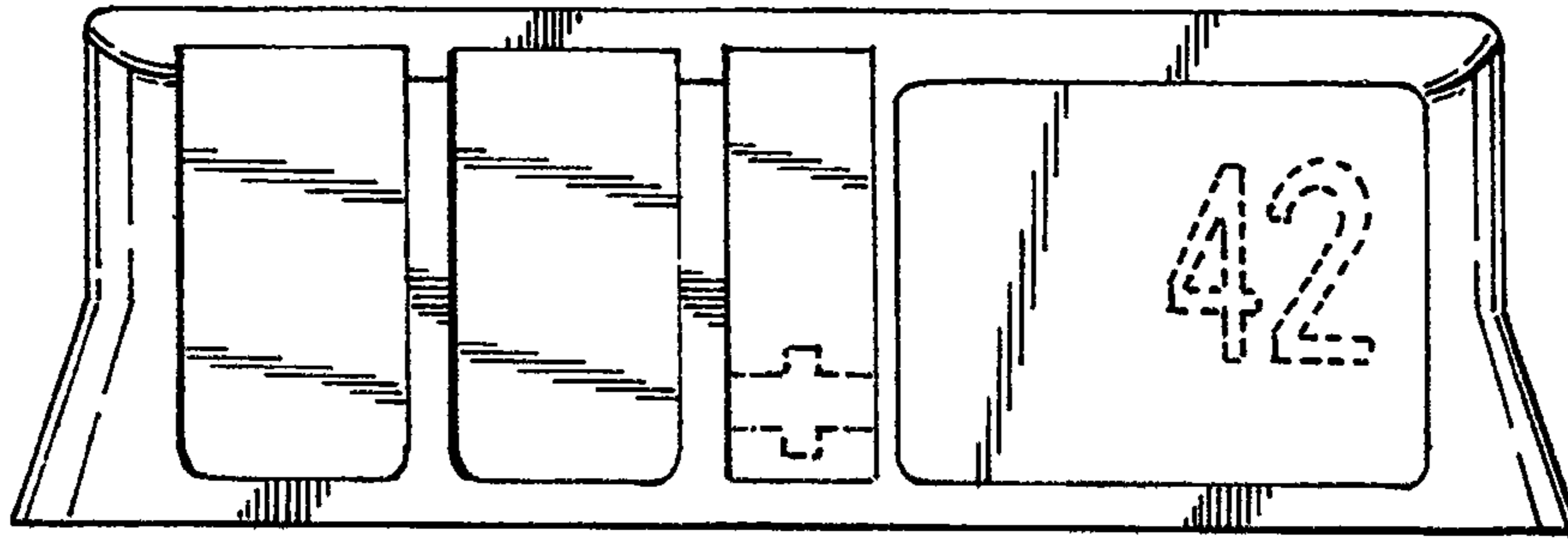

Fig. 4

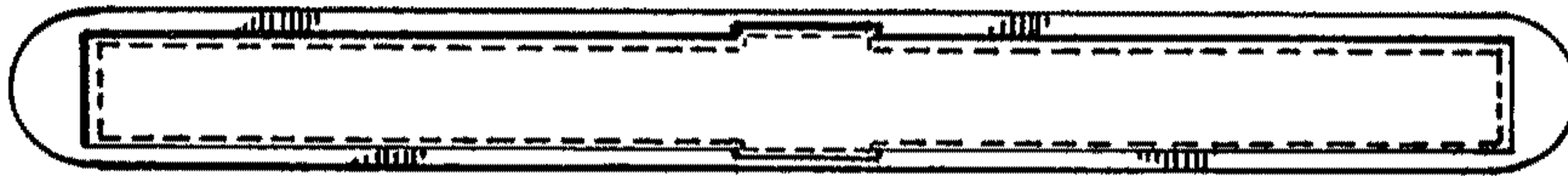

Fig. 5



Fig. 6

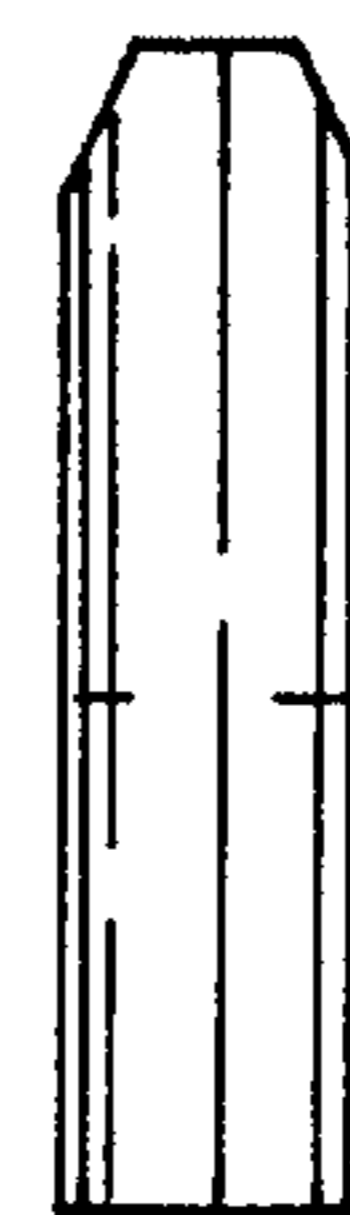

Fig. 7