



US00D684379S

(12) **United States Design Patent**
Sim

(10) **Patent No.:** **US D684,379 S**
(45) **Date of Patent:** **** Jun. 18, 2013**

(54) **SNAP FRAME**

(75) Inventor: **Boon Keng Sim**, Singapore (SG)

(73) Assignee: **Botak Sign Pte Ltd**, Singapore (SG)

(**) Term: **14 Years**

(21) Appl. No.: **29/414,033**

(22) Filed: **Feb. 23, 2012**

(30) **Foreign Application Priority Data**

Aug. 23, 2011 (SG) D2011/908/B

(51) **LOC (9) Cl.** **06-07**

(52) **U.S. Cl.**
USPC **D6/300**

(58) **Field of Classification Search**
USPC D6/300-314, 444, 492; 40/700, 799,
40/782, 658, 768, 717, 714, 721, 735, 773;
D19/10, 90-91; D20/43, 40; D14/341, 474;
206/312, 320, 387.1; D9/414-415, 418, 432,
D9/711

See application file for complete search history.

(56) **References Cited**

U.S. PATENT DOCUMENTS

1,094,443	A *	4/1914	Illig	40/700
2,189,521	A *	2/1940	King	40/799
D277,388	S *	1/1985	Ackeret	D6/300
D288,746	S *	3/1987	Allekotte	D6/300
D315,364	S *	3/1991	Scalice et al.	D19/10
D348,486	S *	7/1994	Fischtein et al.	D20/40

5,819,458	A *	10/1998	Hadden	40/782
D417,098	S *	11/1999	Teufel et al.	D6/492
D624,598	S *	9/2010	Chida et al.	D20/43
D627,779	S *	11/2010	Liao	D14/341
D646,322	S *	10/2011	Hertrich, Jr.	D19/26
D646,901	S *	10/2011	Higgins	D6/300
2010/0276562	A1 *	11/2010	Nguyen	248/488

* cited by examiner

Primary Examiner — Philip S Hyder

Assistant Examiner — Sydney Buffalow

(74) *Attorney, Agent, or Firm* — Seed IP Law Group PLLC

(57) **CLAIM**

The ornamental design for a snap frame, as shown and described.

DESCRIPTION

FIG. 1 shows a front perspective view of a snap frame.
 FIG. 2 shows a rear perspective view of the snap frame.
 FIG. 3 shows a front view of the snap frame.
 FIG. 4 shows a rear view of the snap frame.
 FIG. 5 shows a right side view of the snap frame.
 FIG. 6 shows a left side view of the snap frame.
 FIG. 7 shows a top view of the snap frame.
 FIG. 8 shows a bottom view of the snap frame.
 FIG. 9 shows an exploded front view of the snap frame with parts disassembled; and,
 FIG. 10 shows a zoom-in front view of one corner of the snap frame.

The broken lines shown in the drawings are directed to environmental structure that forms no part of the claimed design.

1 Claim, 10 Drawing Sheets

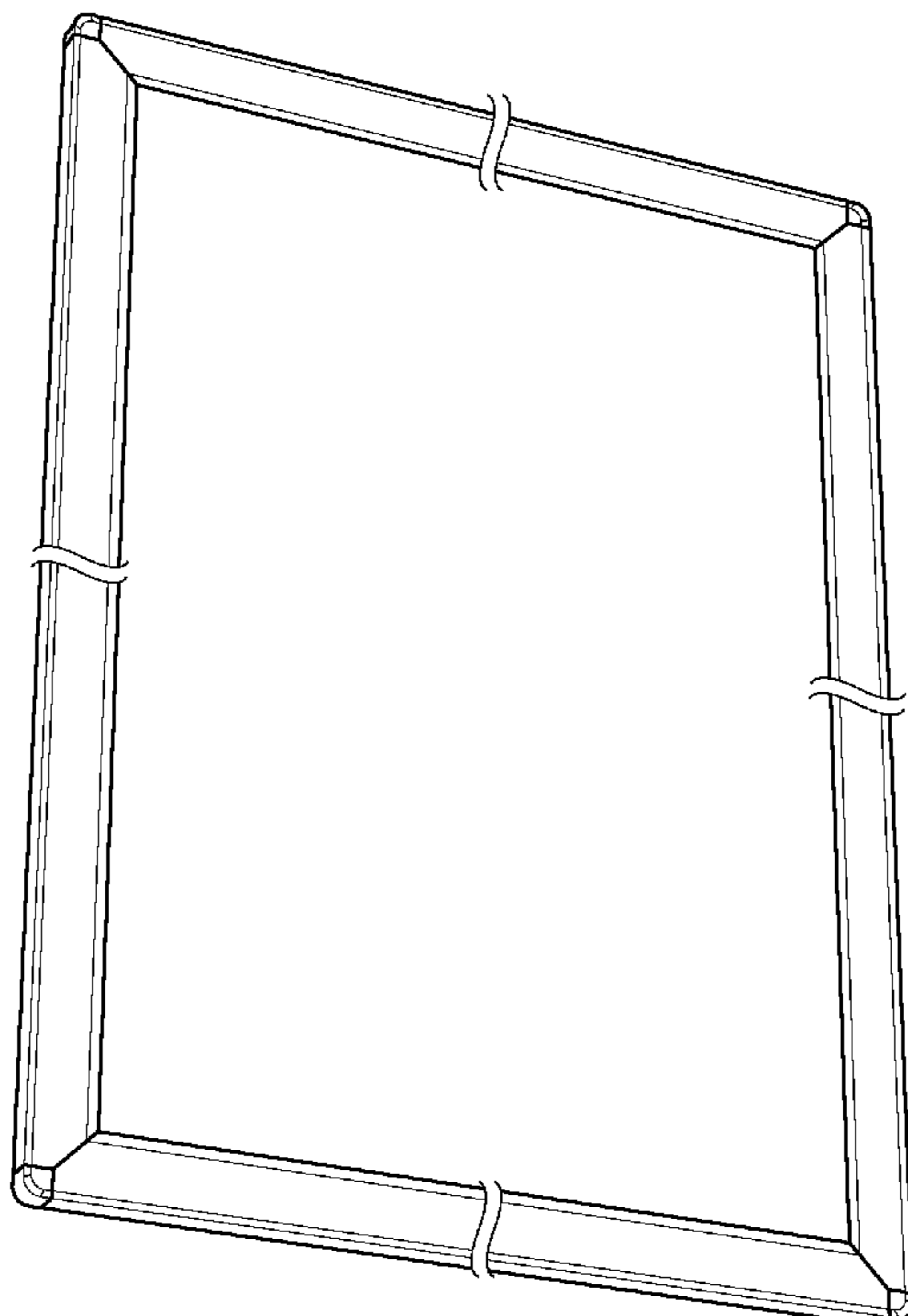

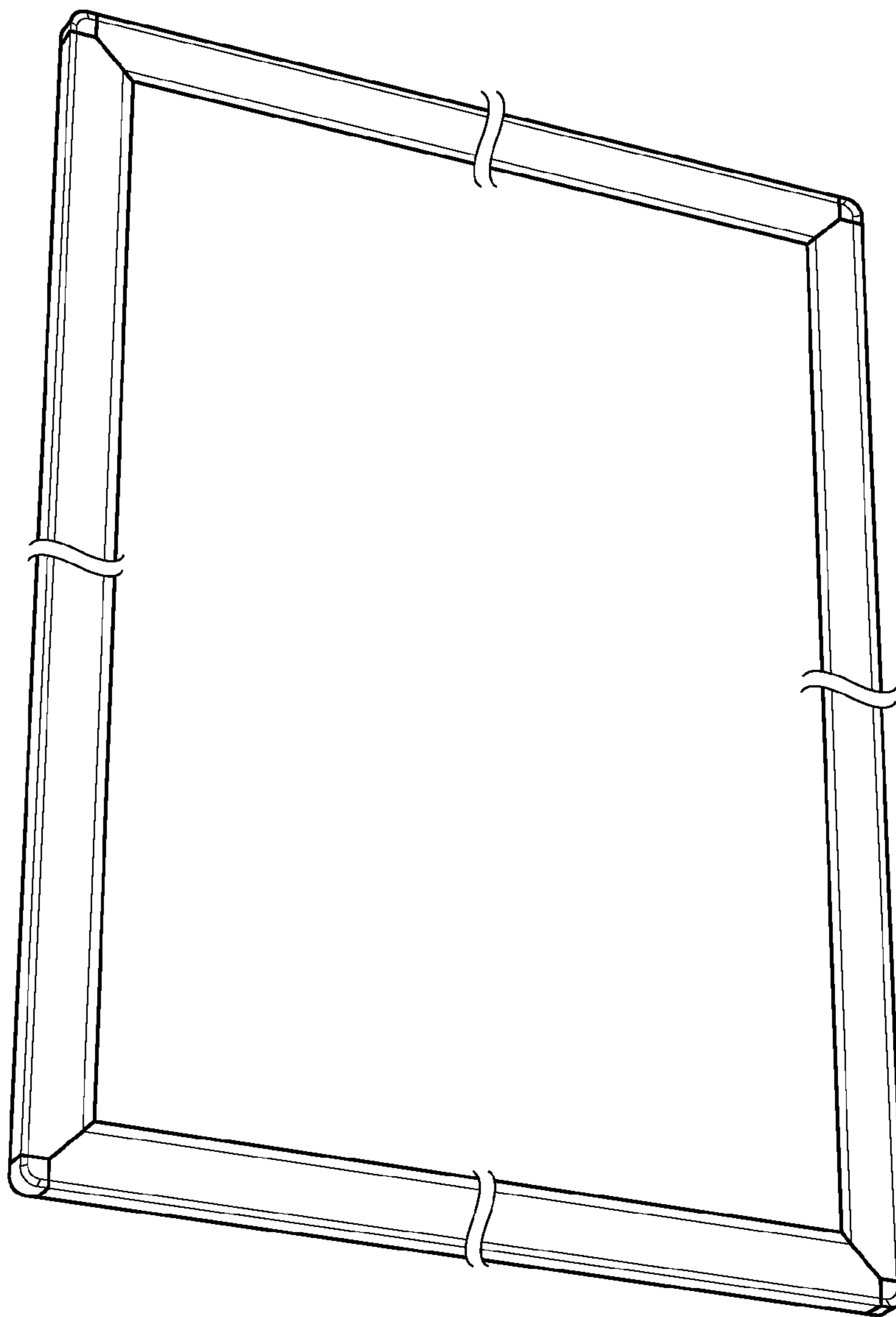

FIG. 1

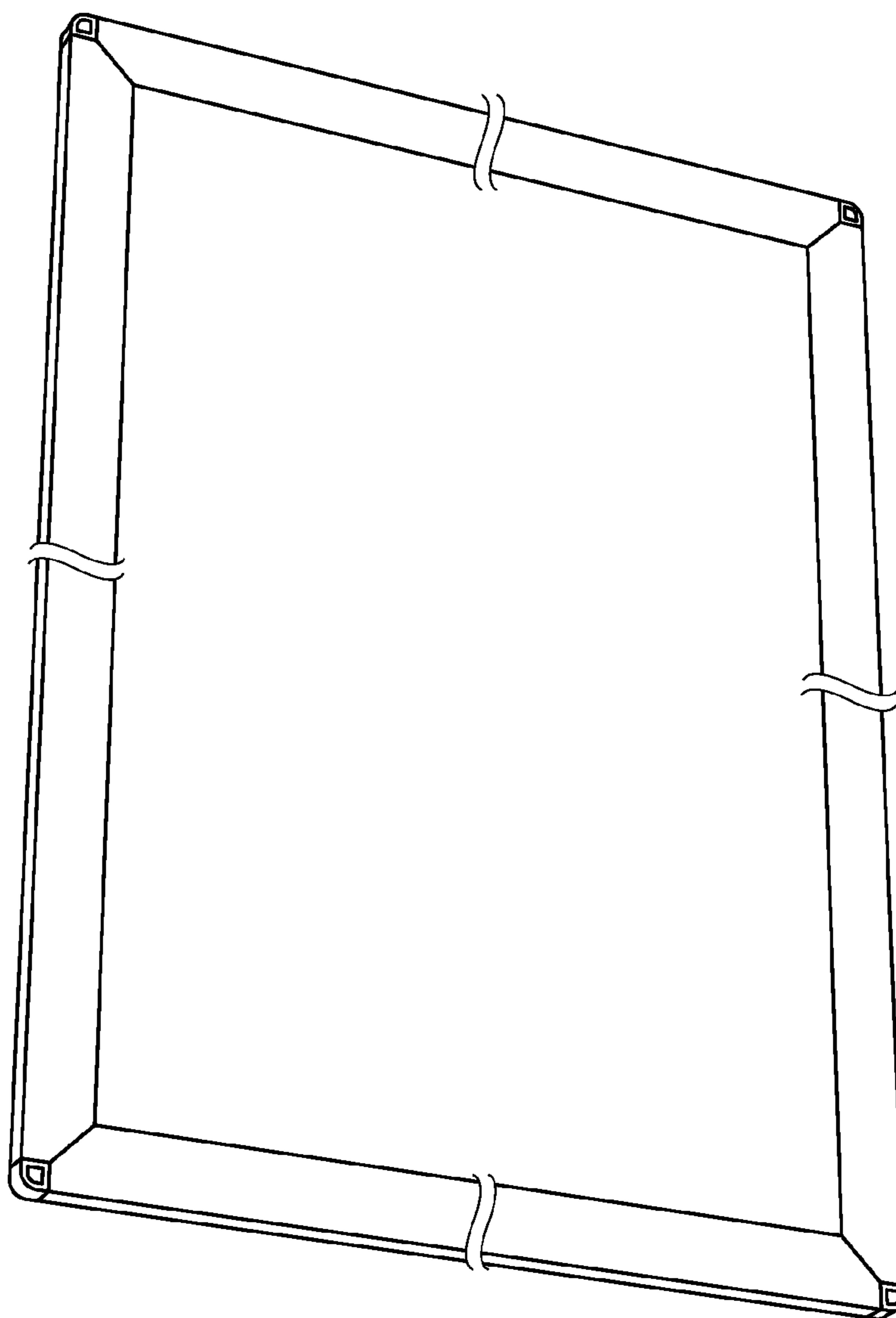

FIG. 2

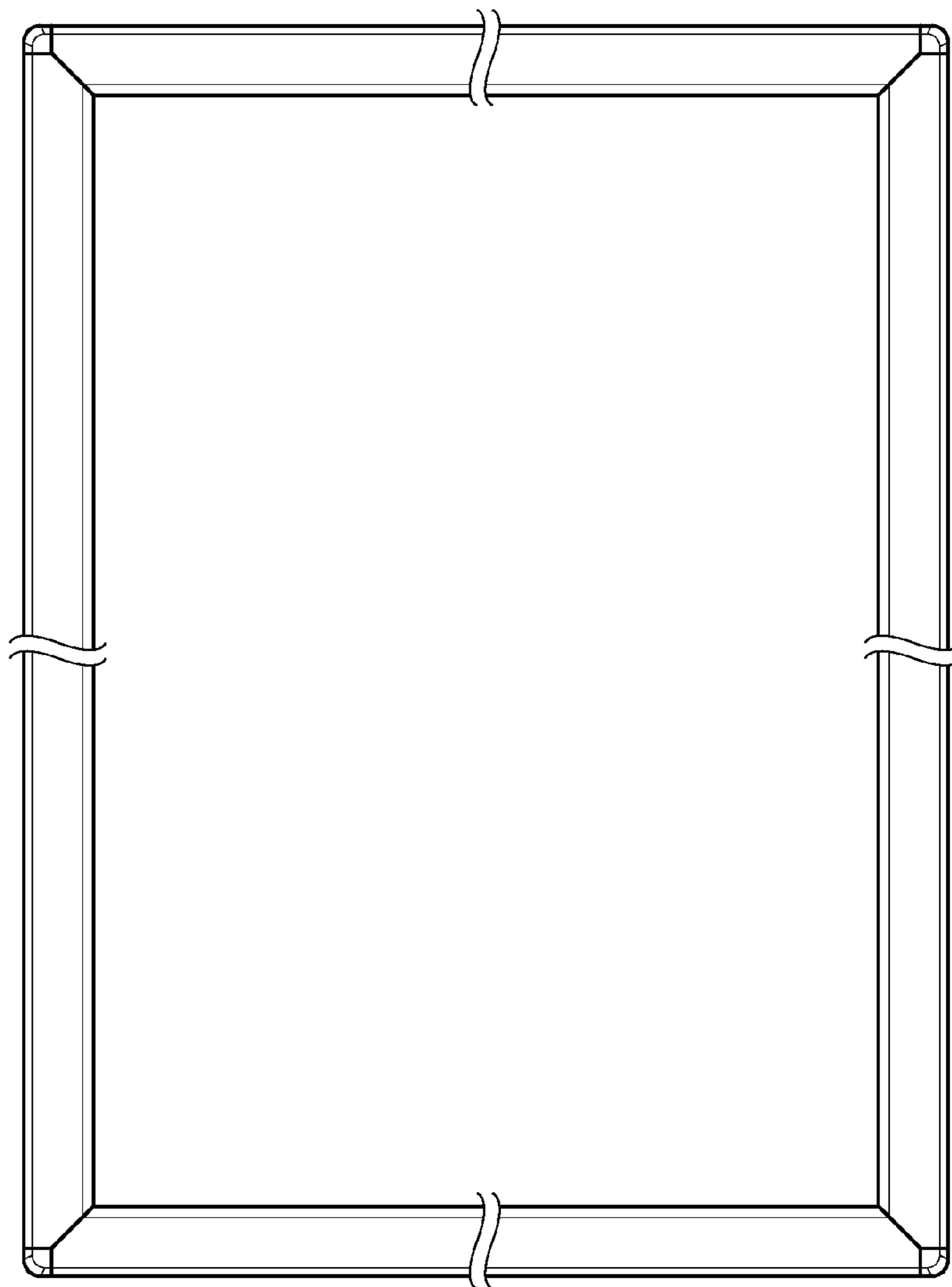

FIG. 3

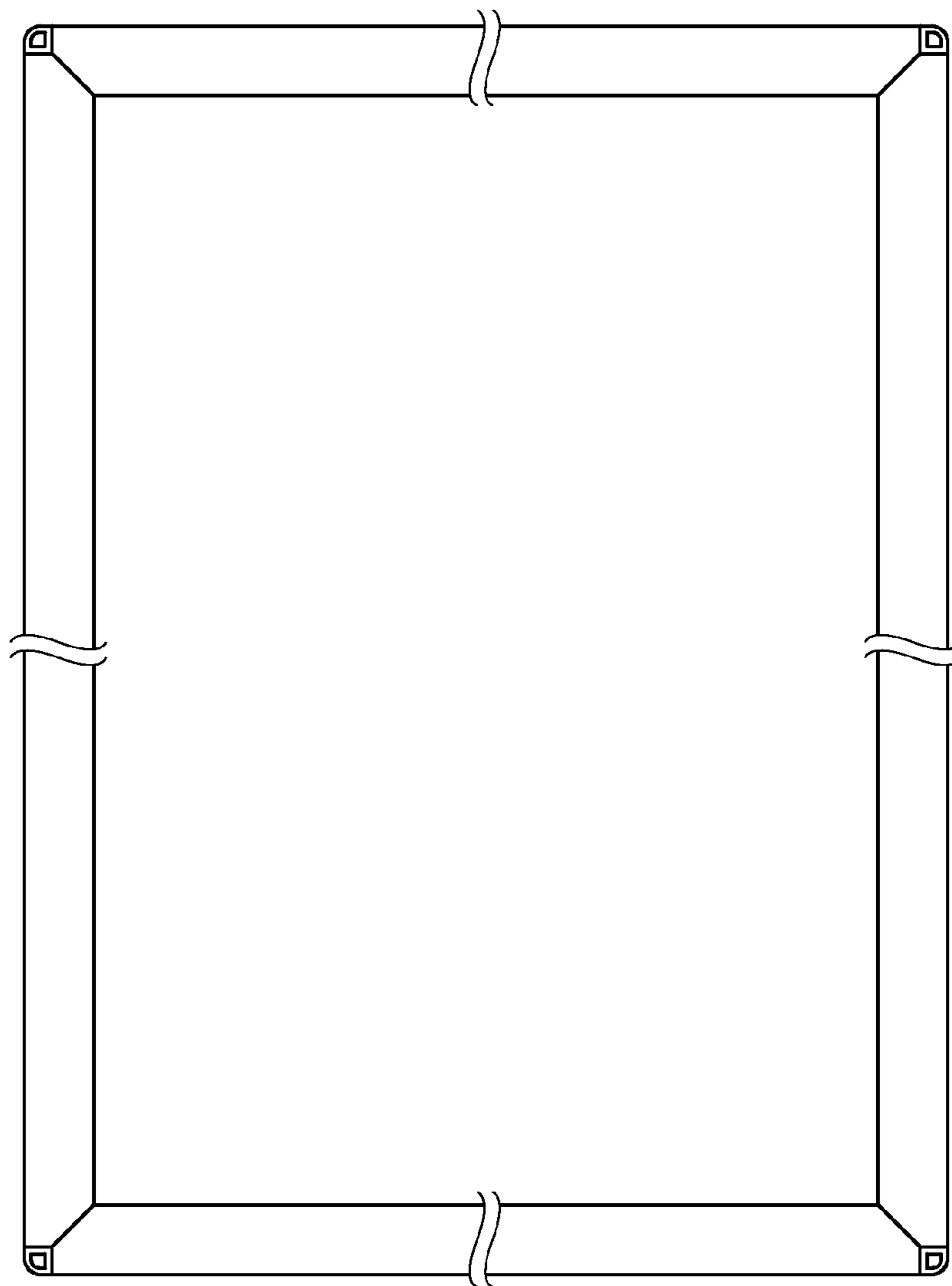

FIG. 4

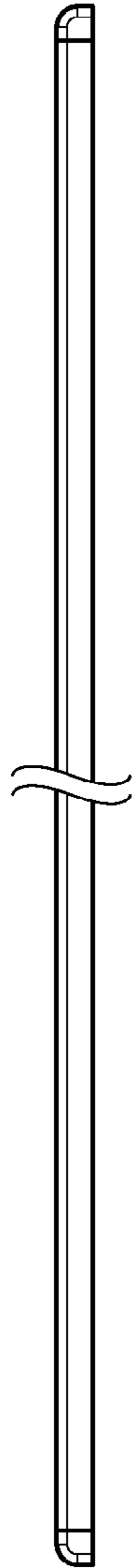

FIG. 5

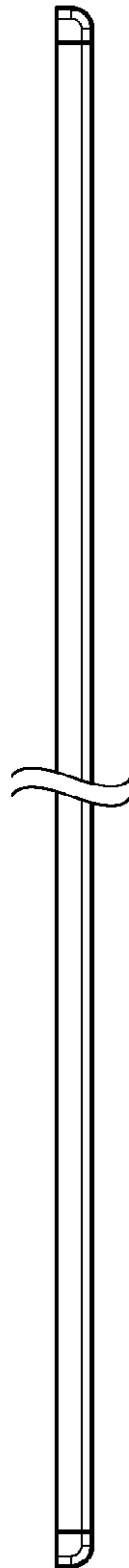

FIG. 6

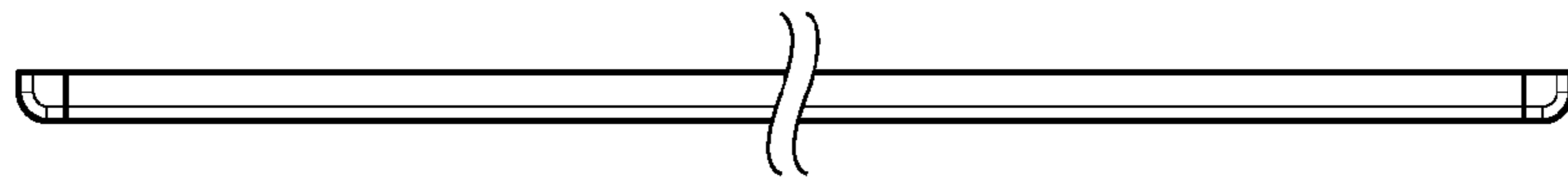

FIG. 7

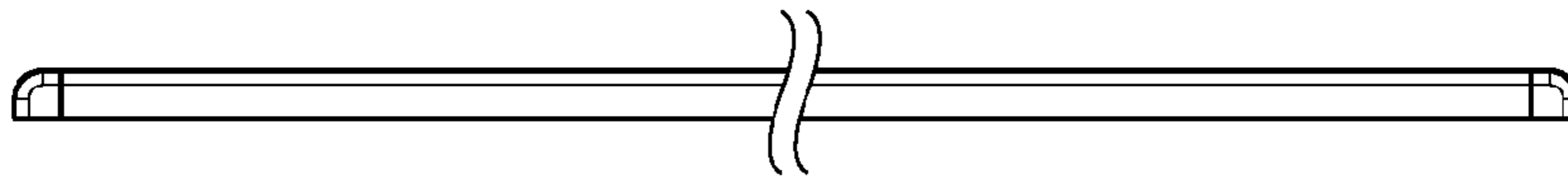

FIG. 8

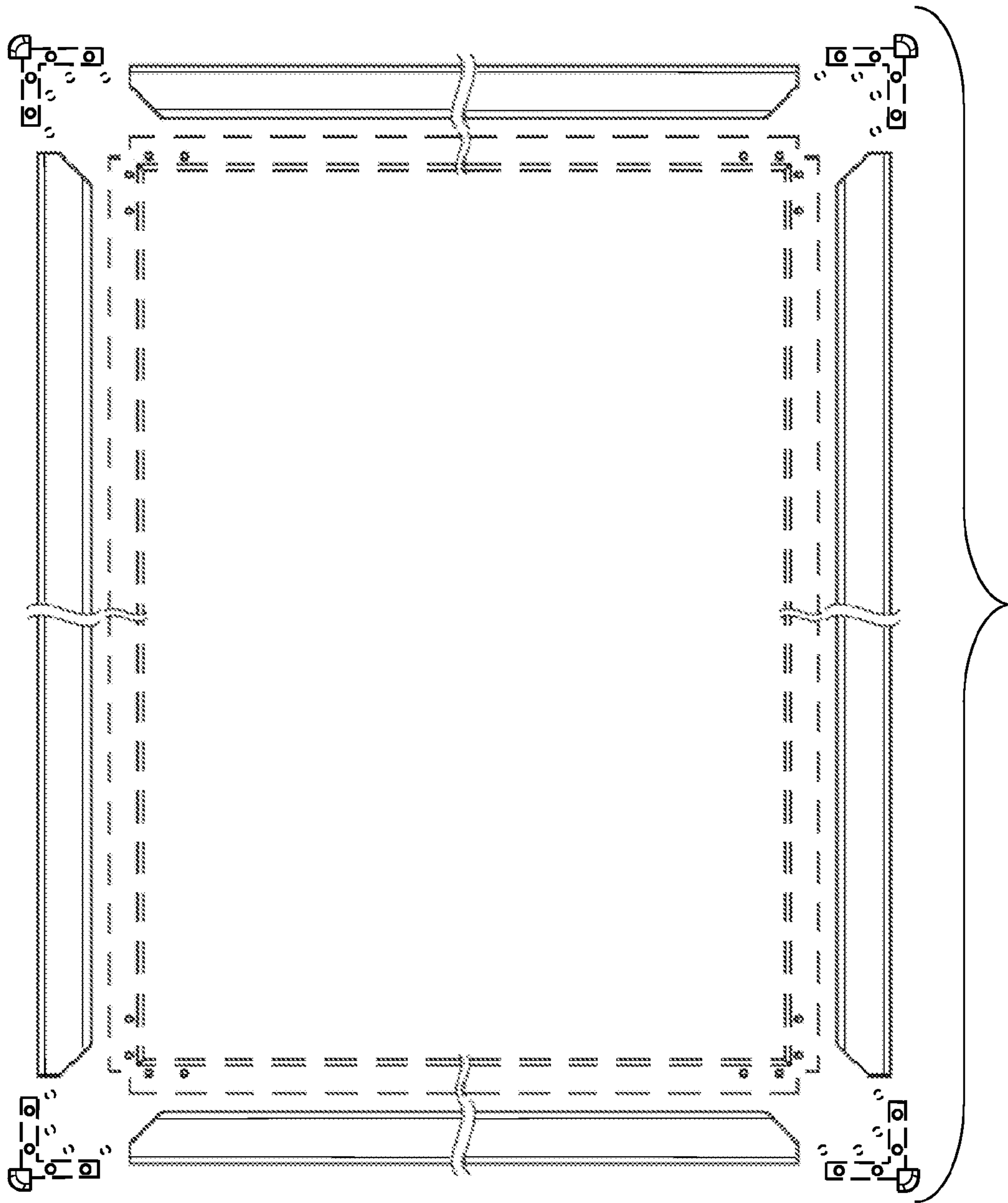

FIG. 9

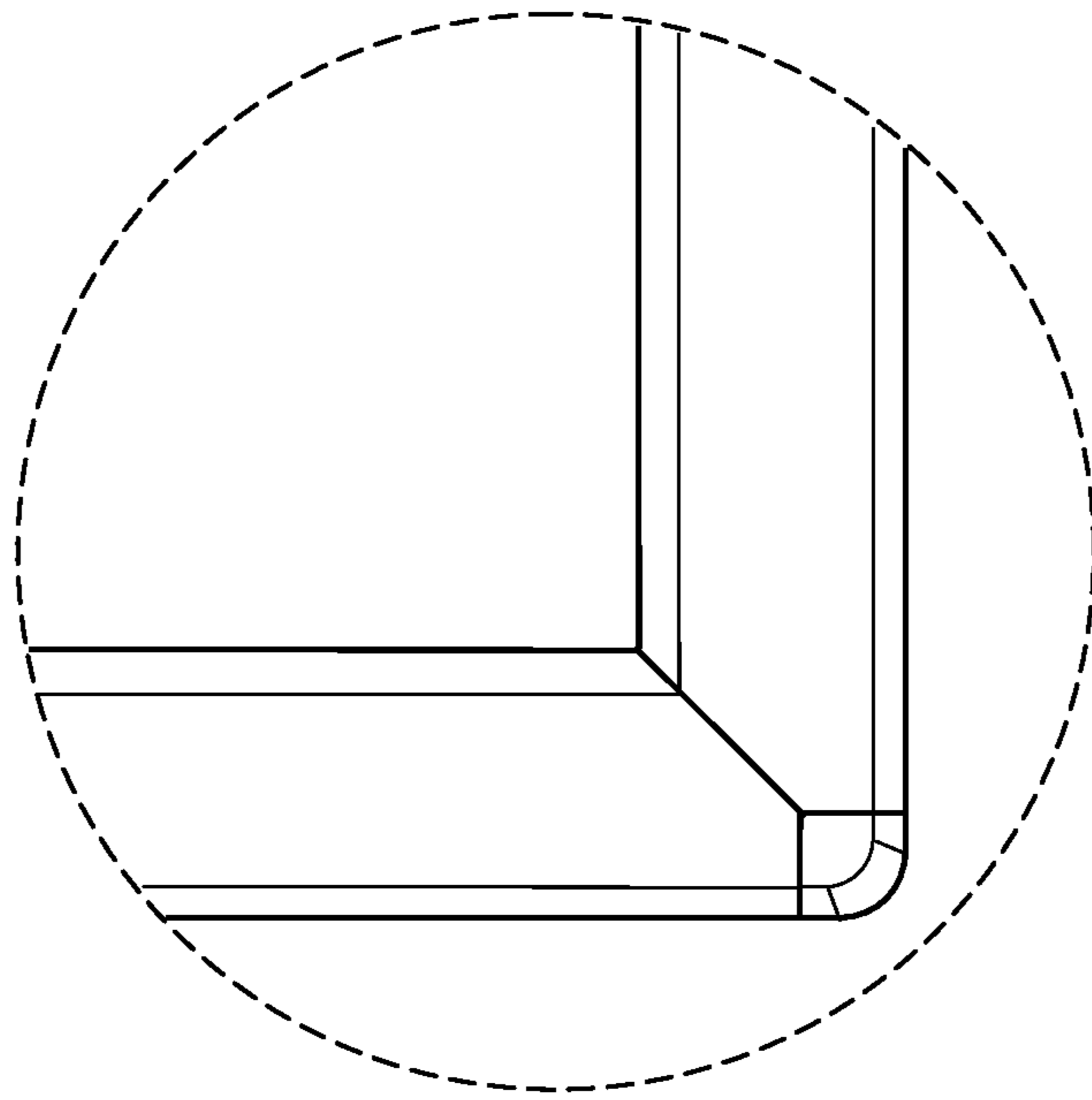

FIG. 10