



US00D684254S

(12) **United States Design Patent**
Zuyderhoudt

(10) **Patent No.:** **US D684,254 S**
(45) **Date of Patent:** **** Jun. 11, 2013**

(54) **INHALER**

(75) Inventor: **Krijn Franciscus Marie Zuyderhoudt**,
Leiden (NL)

(73) Assignee: **Pharmachemie B.V.**, Haarlem (NL)

(**) Term: **14 Years**

(21) Appl. No.: **29/391,855**

(22) Filed: **May 13, 2011**

(30) **Foreign Application Priority Data**

Nov. 18, 2010 (EM) 001245492-0001

(51) **LOC (9) Cl.** **29-02**

(52) **U.S. Cl.**
USPC **D24/110**

(58) **Field of Classification Search**
USPC D24/110; 128/203.15, 203.21, 200.14,
128/200.23, 205.24, 202.21
See application file for complete search history.

(56) **References Cited**

U.S. PATENT DOCUMENTS

D518,171 S * 3/2006 Anderson et al. D24/110
D576,724 S * 9/2008 Jensen et al. D24/110
D590,495 S * 4/2009 Lulla et al. D24/110
D590,938 S * 4/2009 Lulla et al. D24/110

D641,076 S * 7/2011 Grunstad et al. D24/110
2008/0236579 A1 * 10/2008 Zierenberg et al. 128/203.15
2008/0295833 A1 * 12/2008 Rohrschneider
et al. 128/203.15

FOREIGN PATENT DOCUMENTS

JP 1173584 S 5/2003

* cited by examiner

Primary Examiner — Ian Simmons

Assistant Examiner — Carissa C Fitts

(74) *Attorney, Agent, or Firm* — Christensen O'Connor
Johnson Kindness PLLC

(57) **CLAIM**

The ornamental design for an inhaler, as shown.

DESCRIPTION

FIG. 1 is an isometric view of an inhaler in accordance with aspects of the present disclosure;
FIG. 2 is a top planar view of the inhaler of FIG. 1;
FIG. 3 is a bottom planar view of the inhaler of FIG. 1;
FIG. 4 is a planar view of a first side of the inhaler of FIG. 1;
FIG. 5 is a planar view of a second side of the inhaler of FIG. 1;
FIG. 6 is a planar view of a third side of the inhaler of FIG. 1;
and,
FIG. 7 is a planar view of a fourth side of the inhaler of FIG. 1.

Broken lines are for environmental purposes only and form no part of the design.

1 Claim, 3 Drawing Sheets

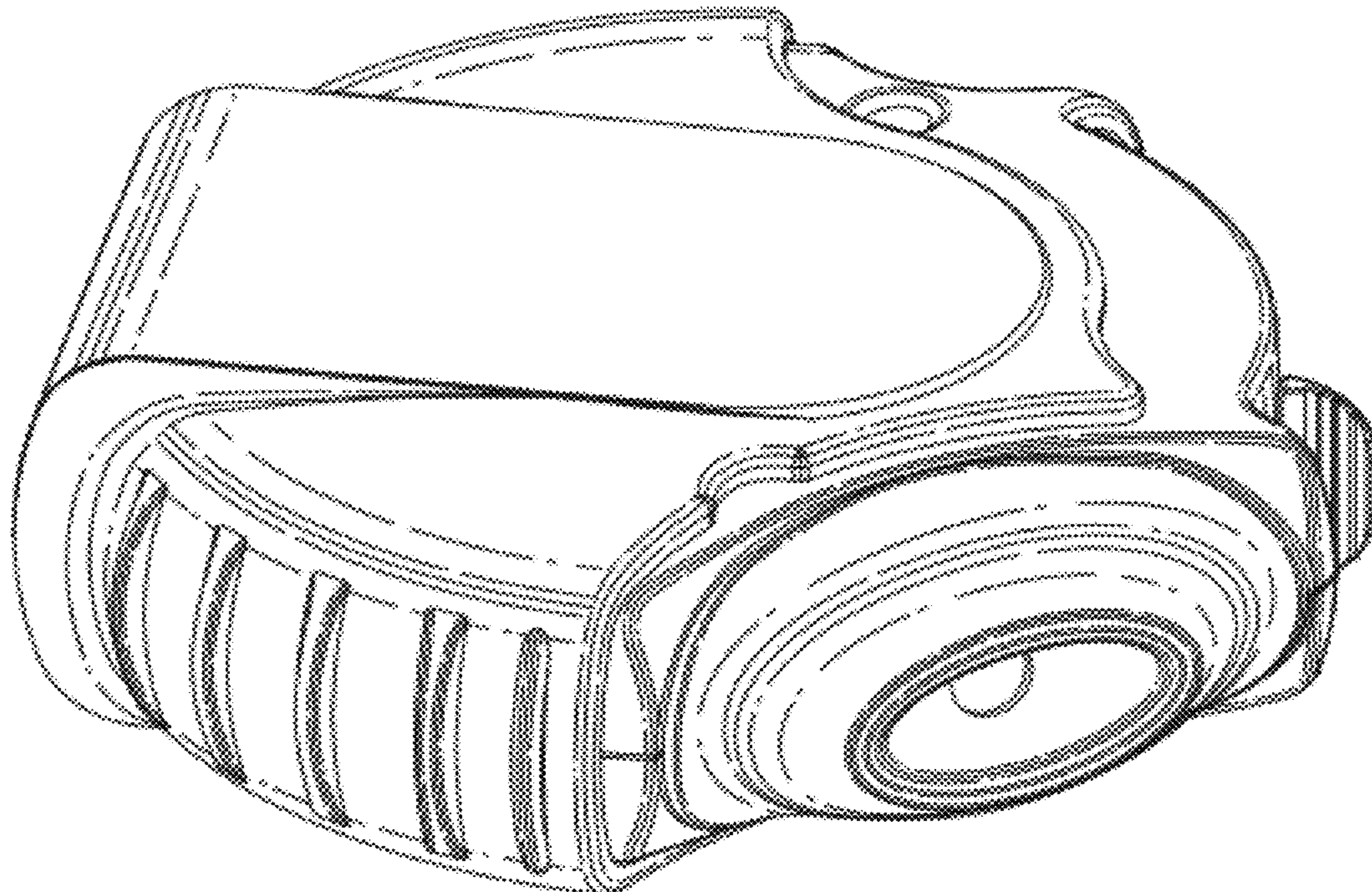

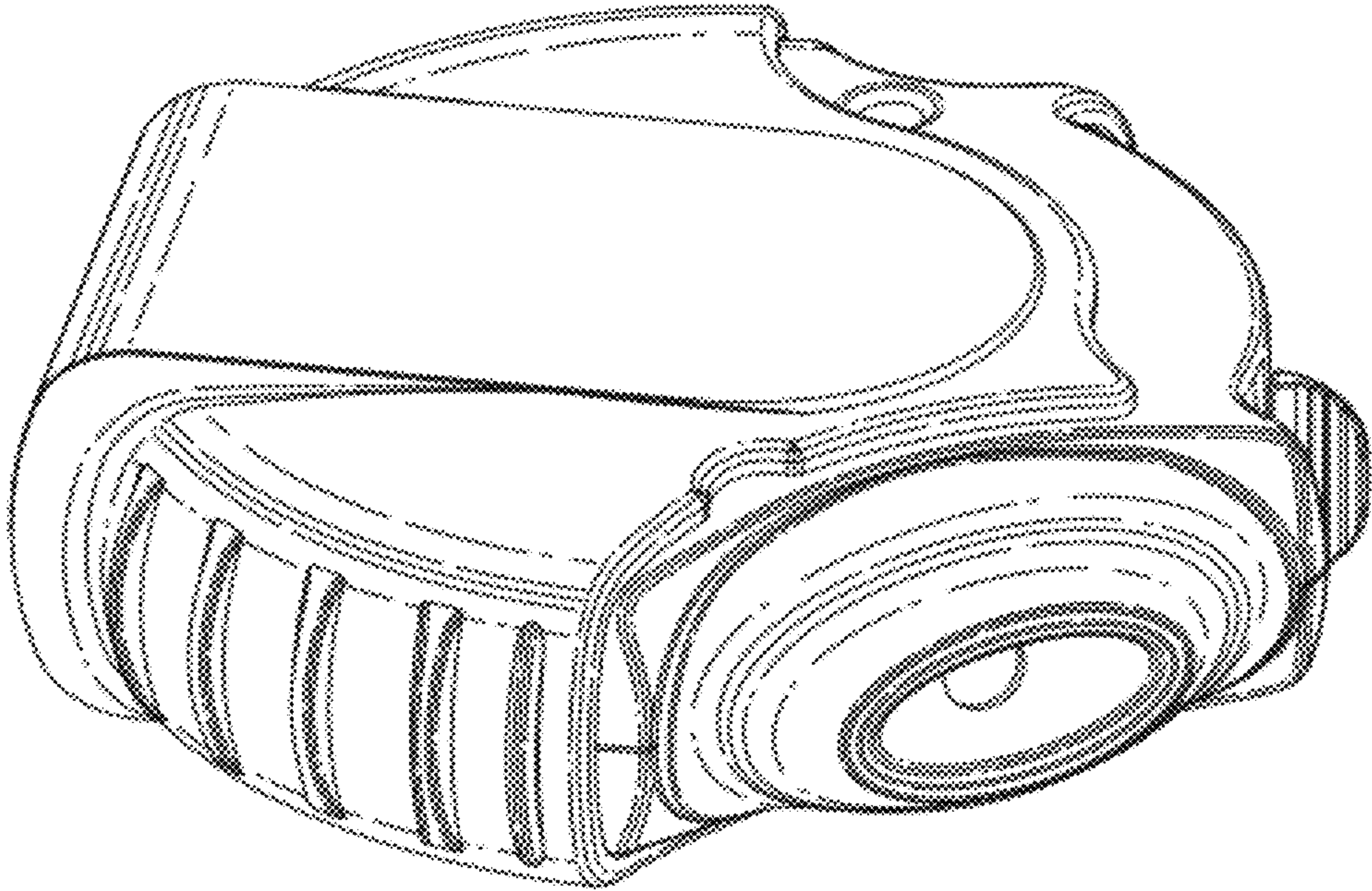

FIG. 1

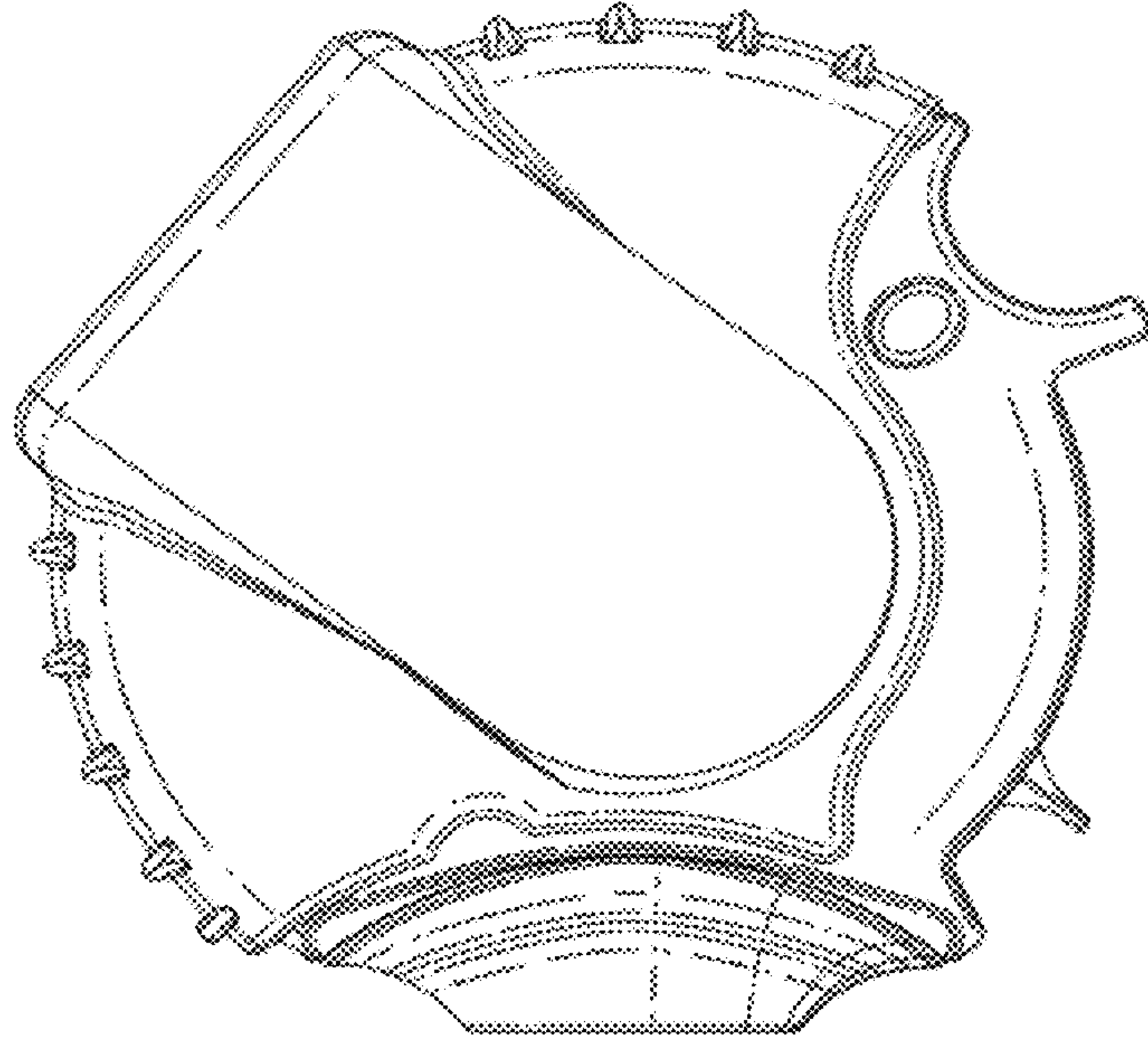

FIG. 2

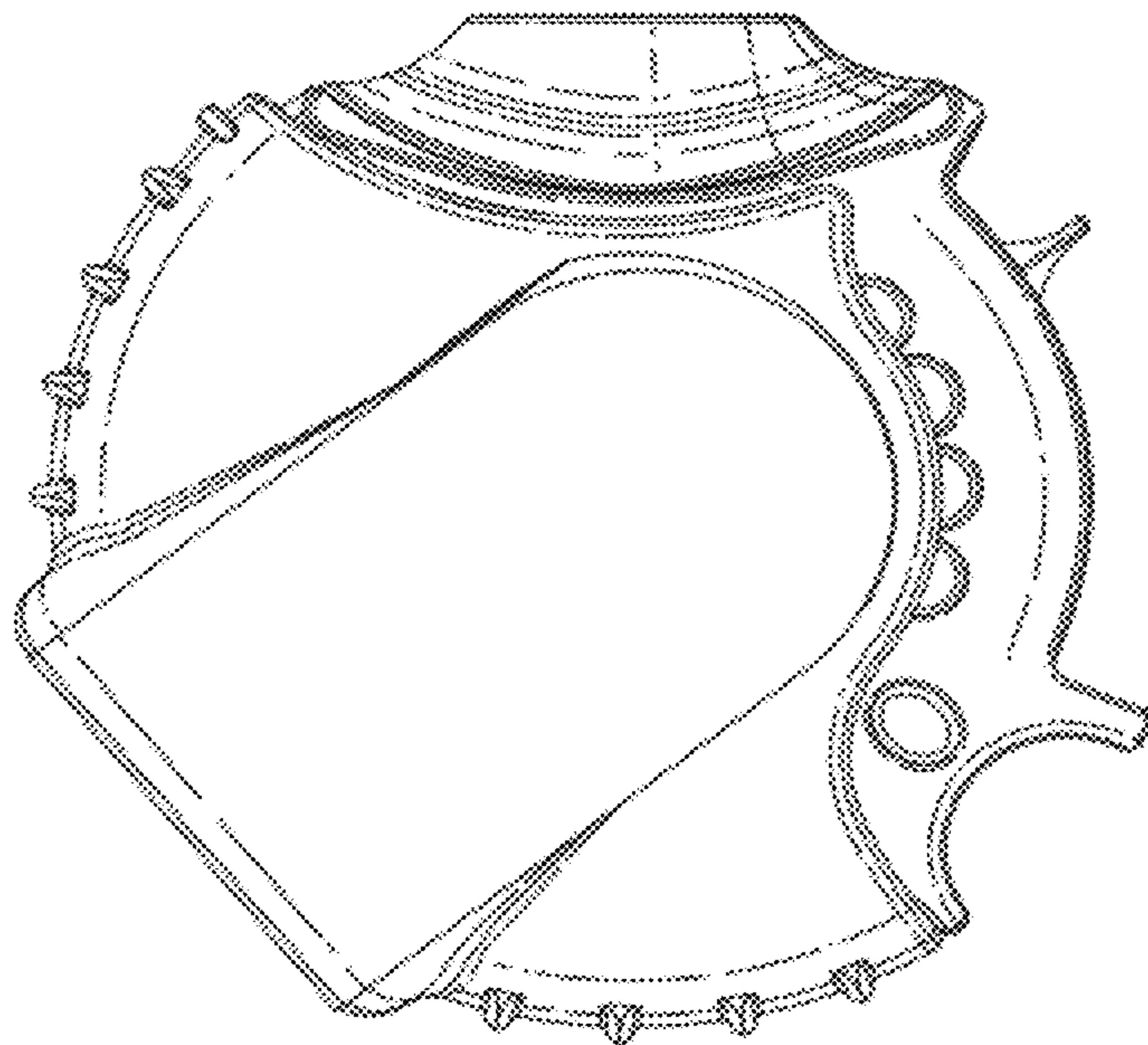

FIG. 3

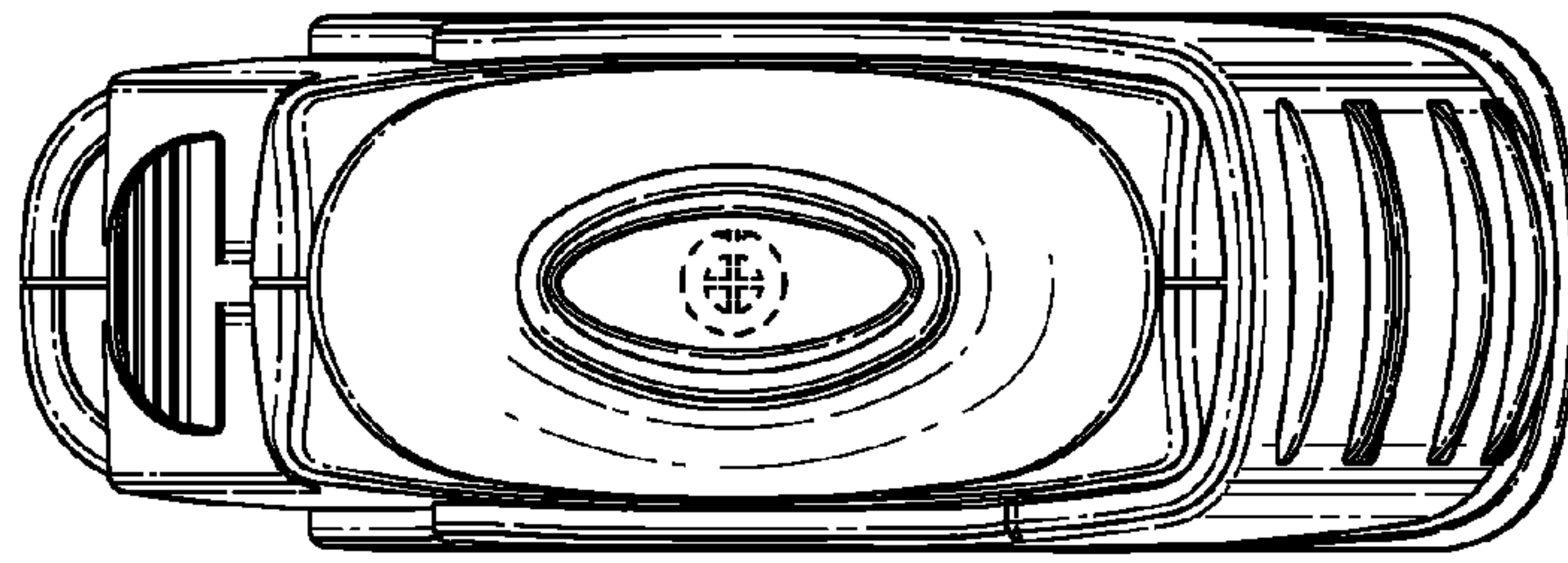

FIG. 4

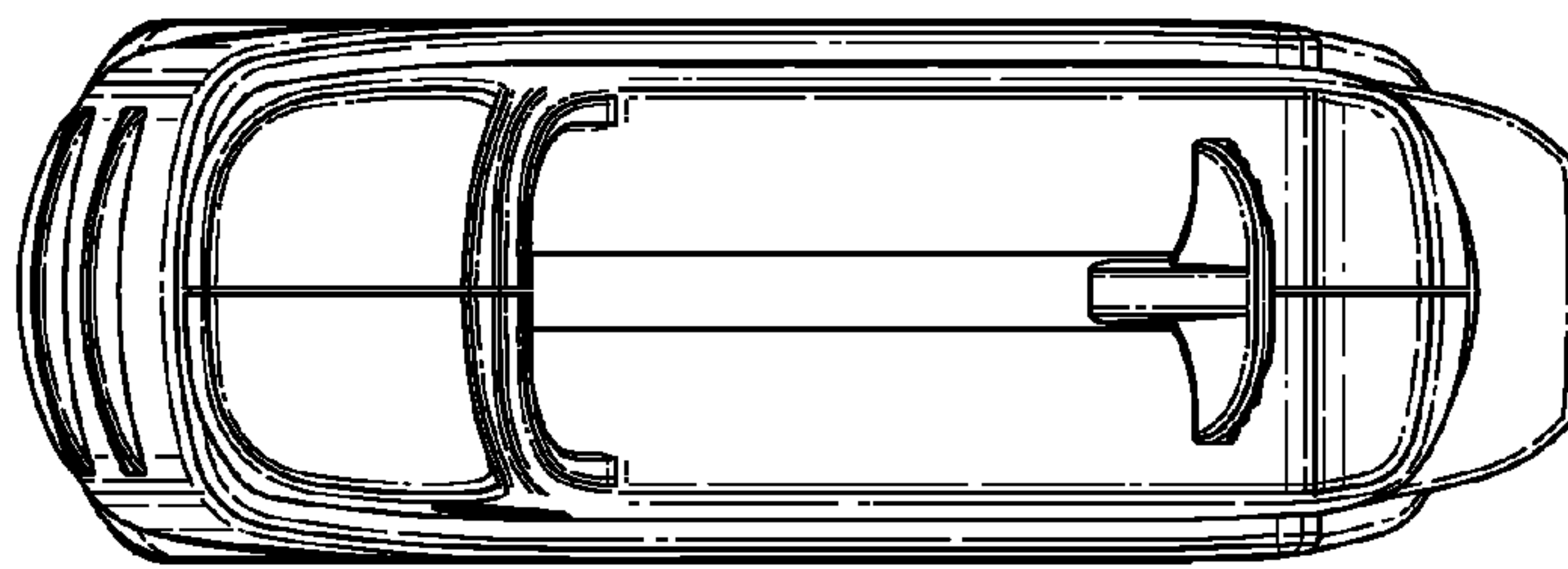

FIG. 5

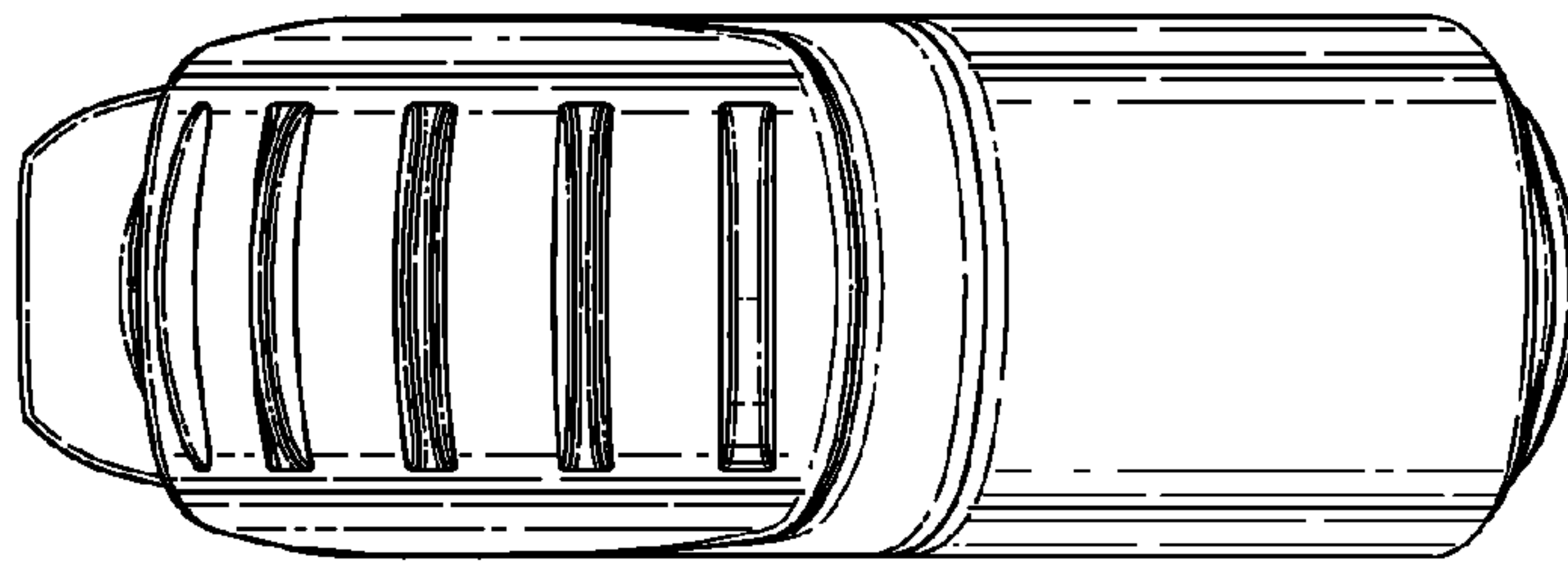

FIG. 6

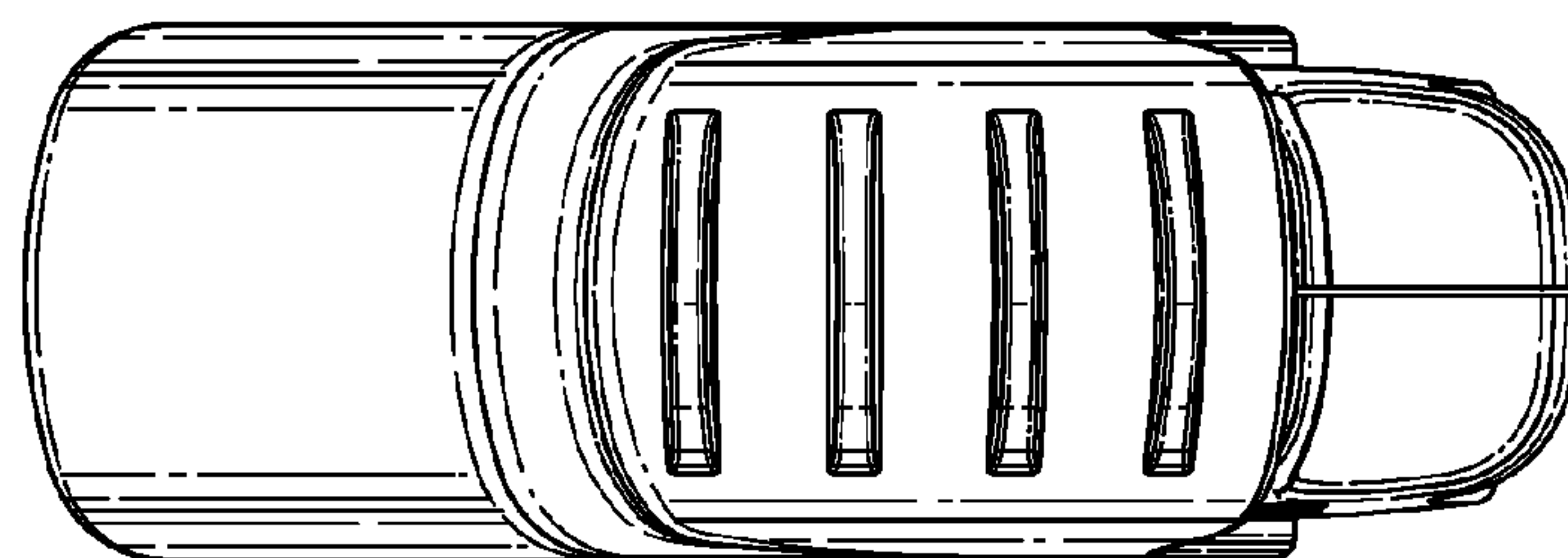

FIG. 7