



US00D684156S

(12) **United States Design Patent**  
**Chan et al.**

(10) **Patent No.:** **US D684,156 S**  
(45) **Date of Patent:** **\*\* Jun. 11, 2013**

(54) **NOTEBOOK COMPUTER**

(75) Inventors: **Hsiao-Ling Chan**, Taipei (TW);  
**Yung-Hsiang Chen**, Taipei (TW); **Hsin Lu**, Taipei (TW); **Kun-Yen Liu**, Taipei (TW); **Wei-Chih Hsu**, Taipei (TW); **Chien-I Lin**, Taipei (TW)

(73) Assignee: **Compal Electronics, Inc.**, Taipei (TW)

(\*\*) Term: **14 Years**

(21) Appl. No.: **29/420,635**

(22) Filed: **May 11, 2012**

(51) **LOC (9) Cl.** ..... **14-02**

(52) **U.S. Cl.**  
USPC ..... **D14/434**

(58) **Field of Classification Search**  
USPC ..... D14/432-434, 314, 204, 420, 421,  
D14/217, 315-327; D18/1, 2, 7, 11; 235/145 A,  
235/145 R; 341/22, 23; 345/104, 156, 168,  
345/169, 173, 87, 901-905; 361/679.01-679.27,  
361/679.31, 679.32, 679.4, 679.41, 679.43,  
361/679.55; 400/486, 489; 710/14; D13/107,  
D13/108, 146; 248/346.03, 176.1; 320/109,  
320/112-115

See application file for complete search history.

(56) **References Cited**

**U.S. PATENT DOCUMENTS**

D318,466 S \* 7/1991 Grundstrom et al. .... D14/434  
D361,324 S \* 8/1995 Rogers ..... D14/434

(Continued)

*Primary Examiner* — Freda S Nunn

(74) *Attorney, Agent, or Firm* — Jianq Chyun IP Office

(57) **CLAIM**

The ornamental design for a notebook computer, as shown and described.

**DESCRIPTION**

FIG. 1 is a perspective view of a notebook computer showing a first embodiment of our new design;  
FIG. 2 is a front view of the first embodiment;  
FIG. 3 is a rear view of the first embodiment;  
FIG. 4 is a left side view of the first embodiment;  
FIG. 5 is a right side view of the first embodiment;  
FIG. 6 is a top view of the first embodiment;  
FIG. 7 is a bottom view of the first embodiment;  
FIG. 8 is a perspective view of the first embodiment, shown in closed state;  
FIG. 9 is a perspective view of a notebook computer showing a second embodiment of our new design;  
FIG. 10 is a front view of the second embodiment;  
FIG. 11 is a rear view of the second embodiment;  
FIG. 12 is a left side view of the second embodiment;  
FIG. 13 is a right side view of the second embodiment;  
FIG. 14 is a top view of the second embodiment;  
FIG. 15 is a bottom view of the second embodiment;  
FIG. 16 is a perspective view of the second embodiment, shown in closed state;  
FIG. 17 is a perspective view of a notebook computer showing a third embodiment of our new design;  
FIG. 18 is a front view of the third embodiment;  
FIG. 19 is a rear view of the third embodiment;  
FIG. 20 is a left side view of the third embodiment;  
FIG. 21 is a right side view of the third embodiment;  
FIG. 22 is a top view of the third embodiment;  
FIG. 23 is a bottom view of the third embodiment; and,  
FIG. 24 is a perspective view of the third embodiment, shown in closed state.

The broken line portions of the notebook computer in all views represent unclaimed portions of the claimed design and form no part thereof.

**1 Claim, 24 Drawing Sheets**

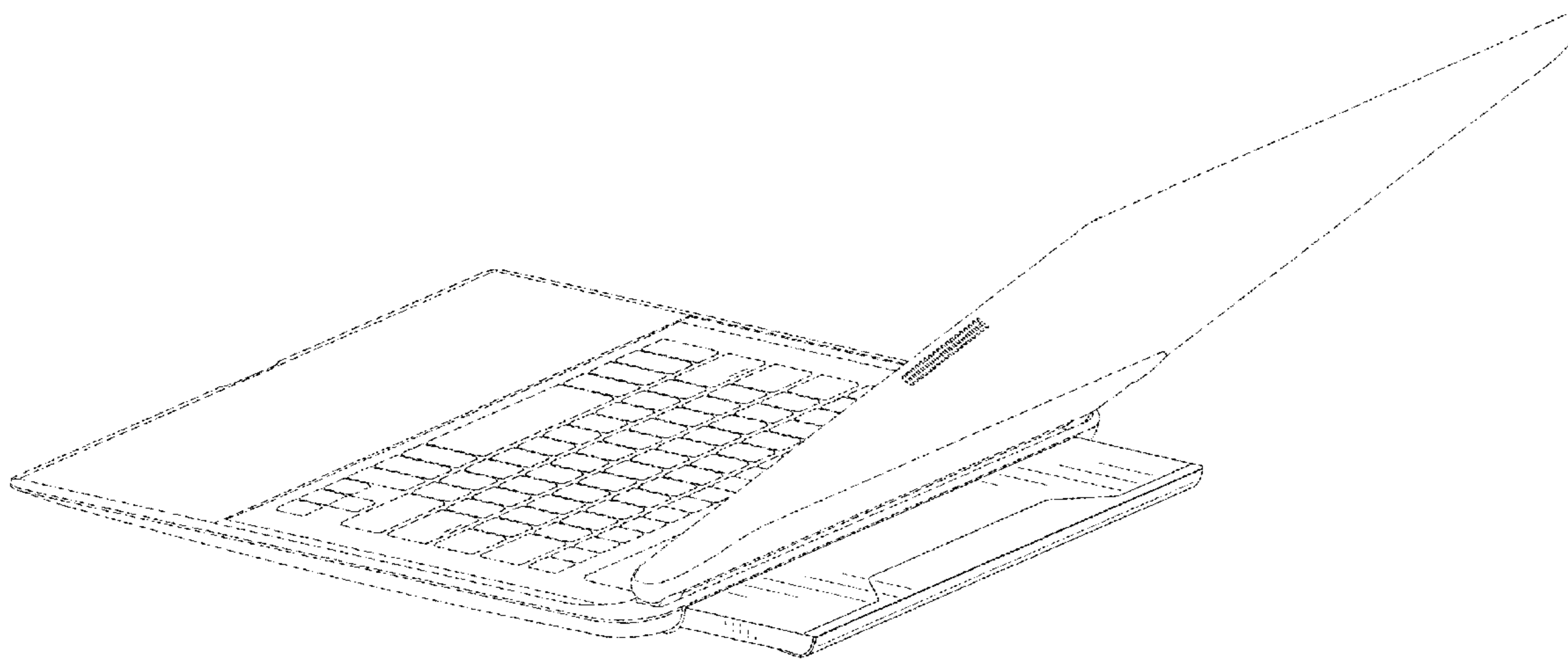

# US D684,156 S

Page 2

---

## U.S. PATENT DOCUMENTS

D364,853 S *	12/1995	Ojeda .....	D14/434	D505,958 S *	6/2005	Cheng .....	D14/434
D366,470 S *	1/1996	Youens et al. ....	D14/434	7,236,356 B2 *	6/2007	Ulla et al. ....	361/679.21
6,683,786 B2 *	1/2004	Yin et al. ....	361/679.4	D648,725 S *	11/2011	Akana et al. ....	D14/434

\* cited by examiner

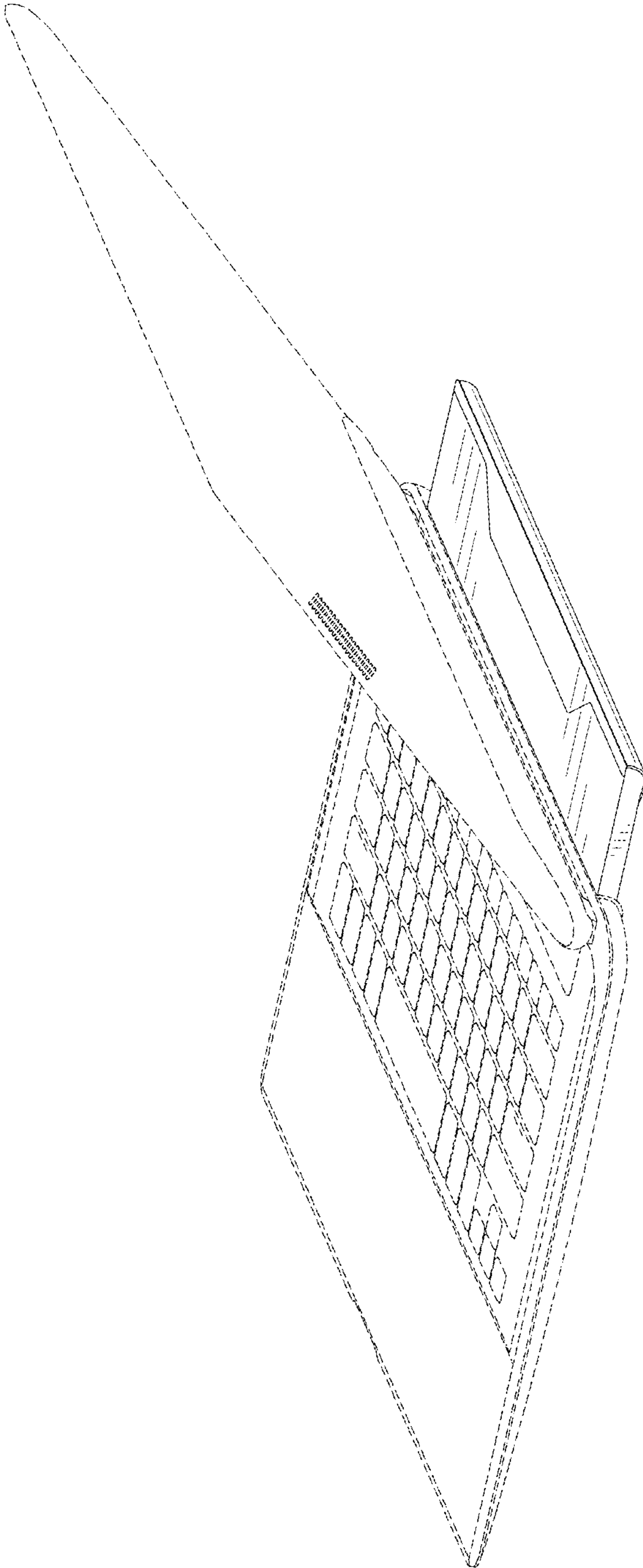

FIG. 1

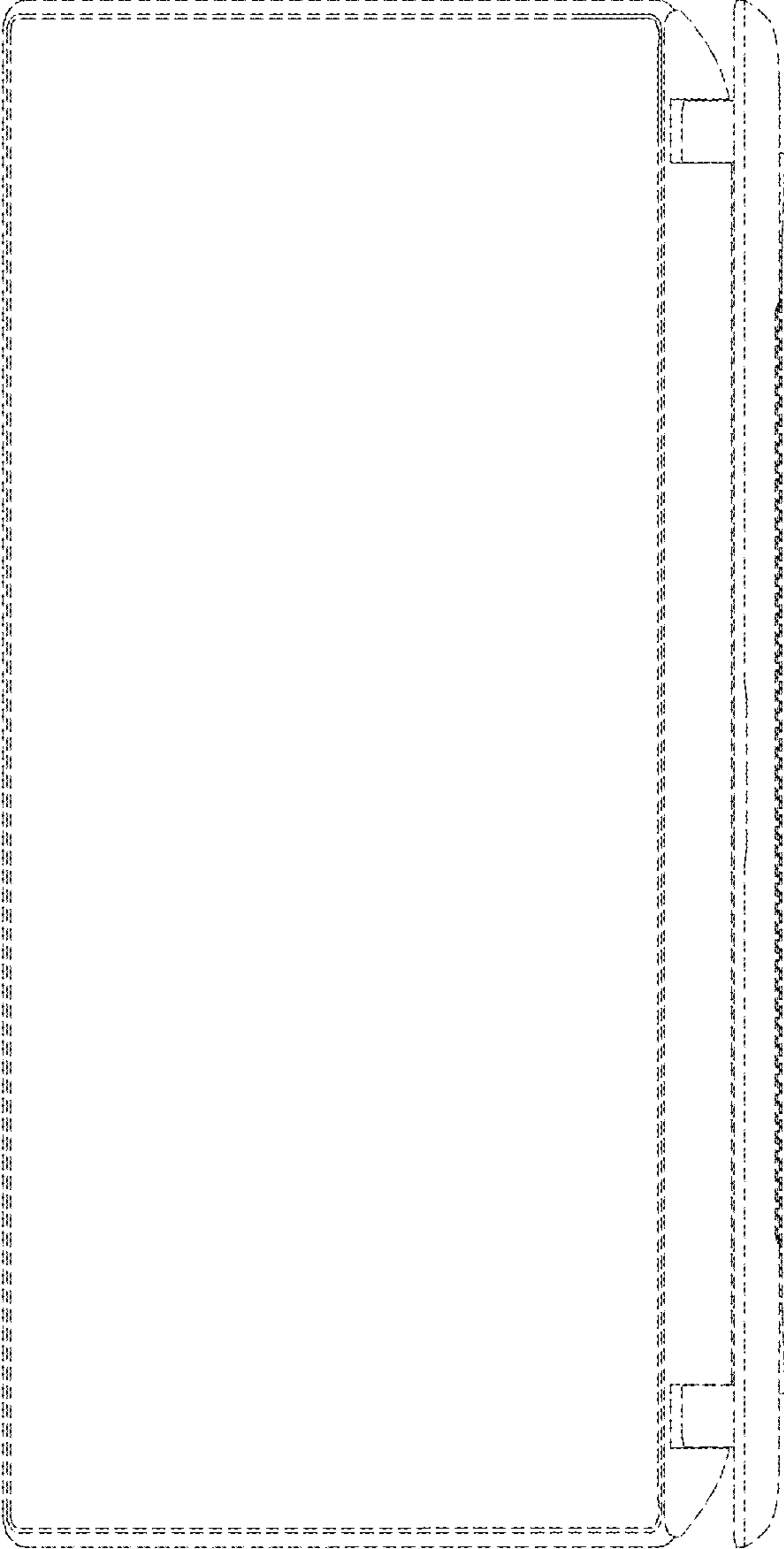

FIG. 2

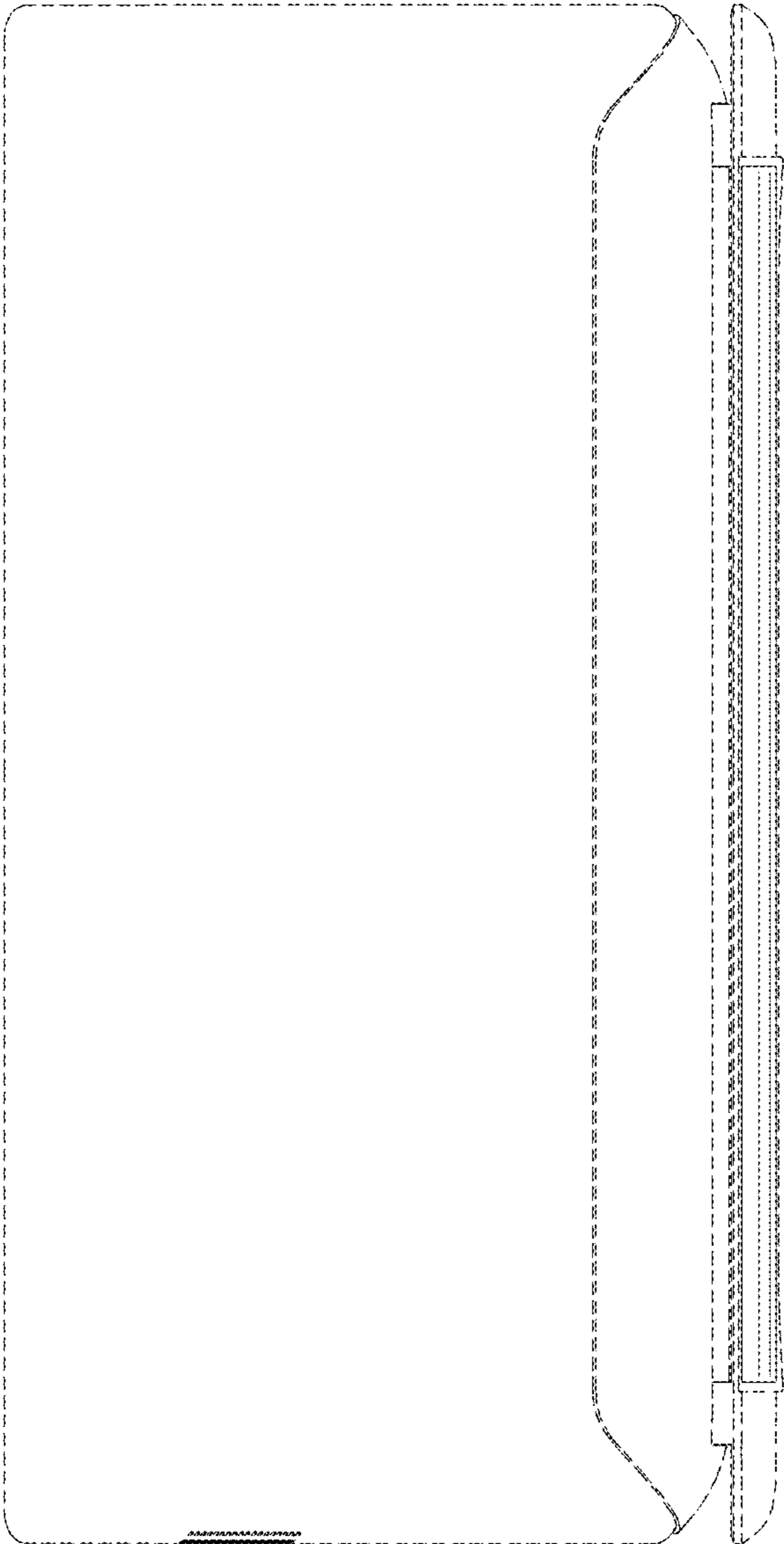

FIG. 3

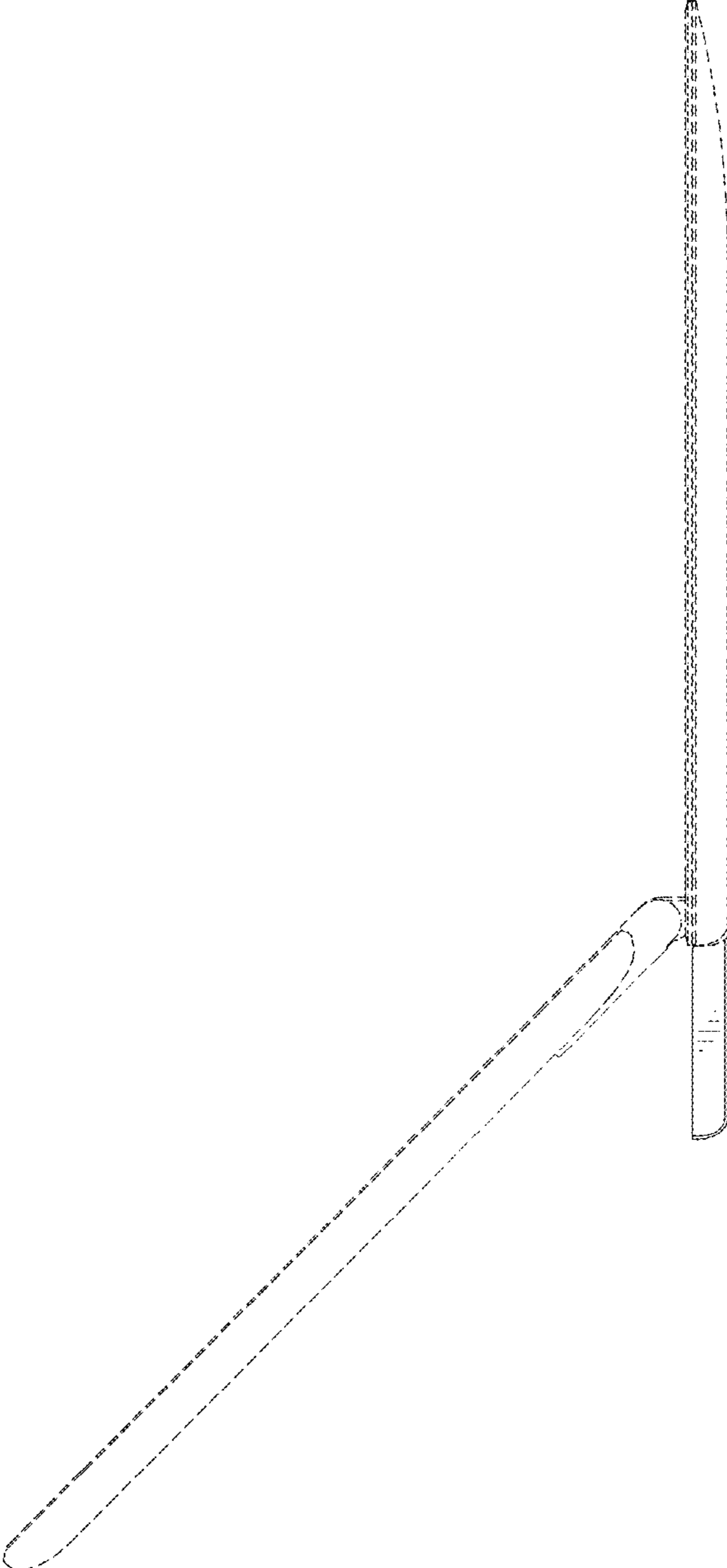

FIG. 4

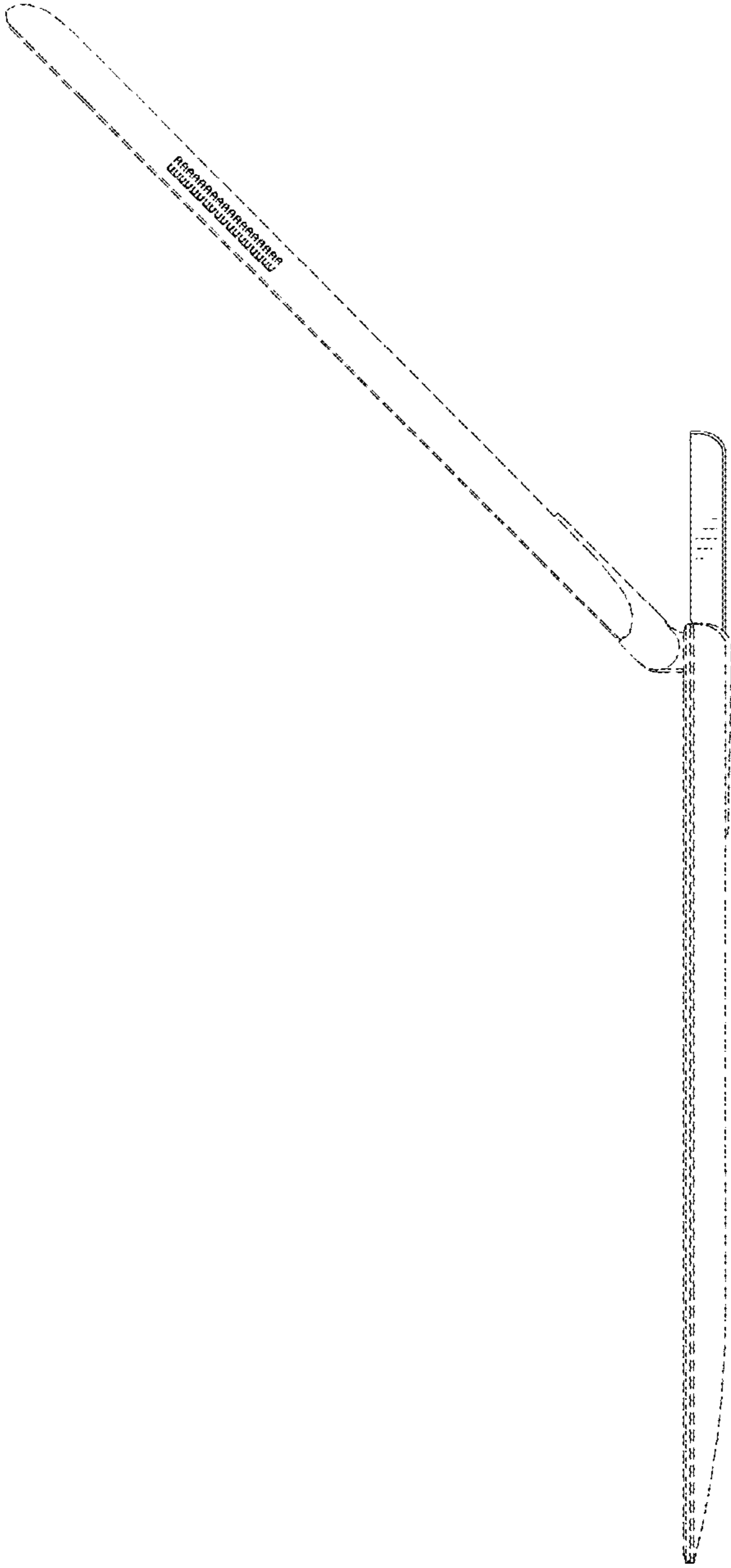

FIG. 5

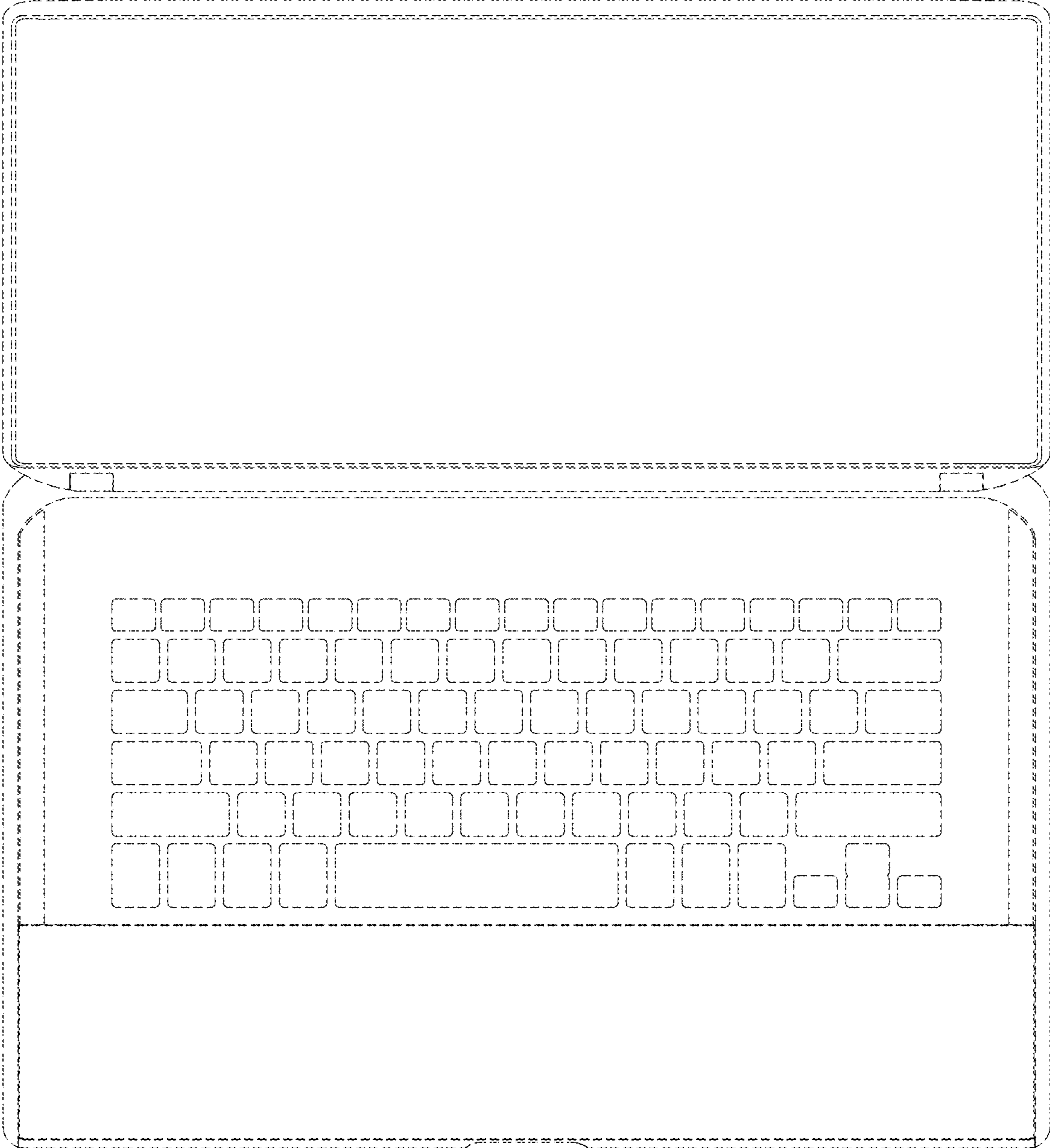

FIG. 6



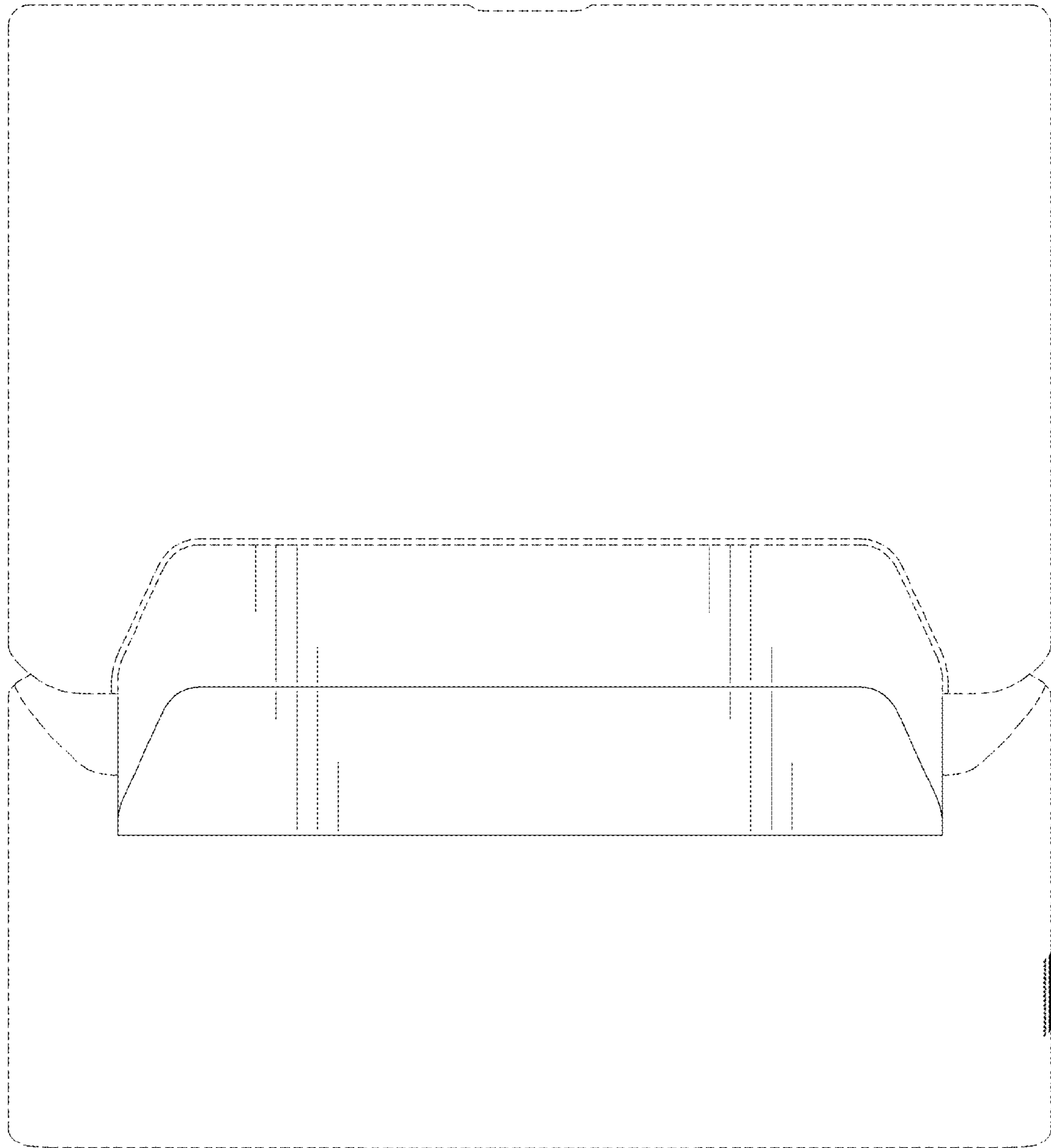

FIG. 7

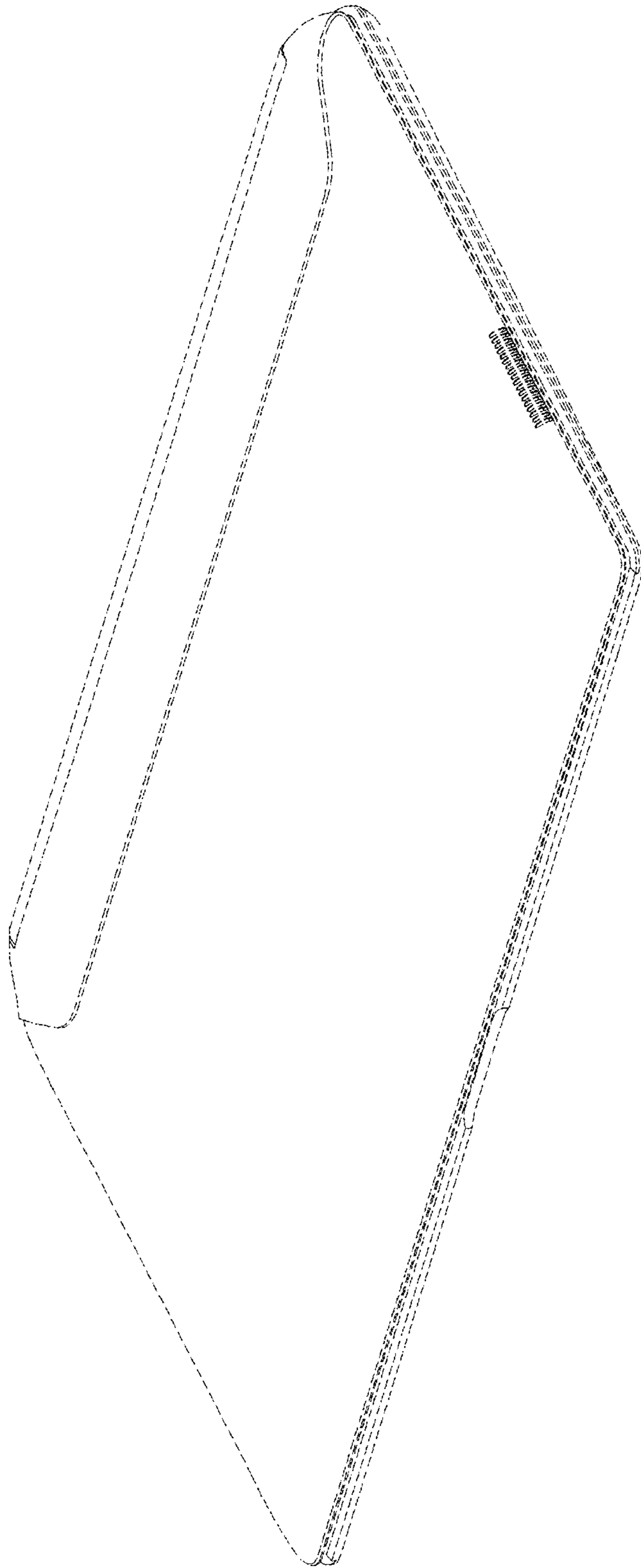

FIG. 8

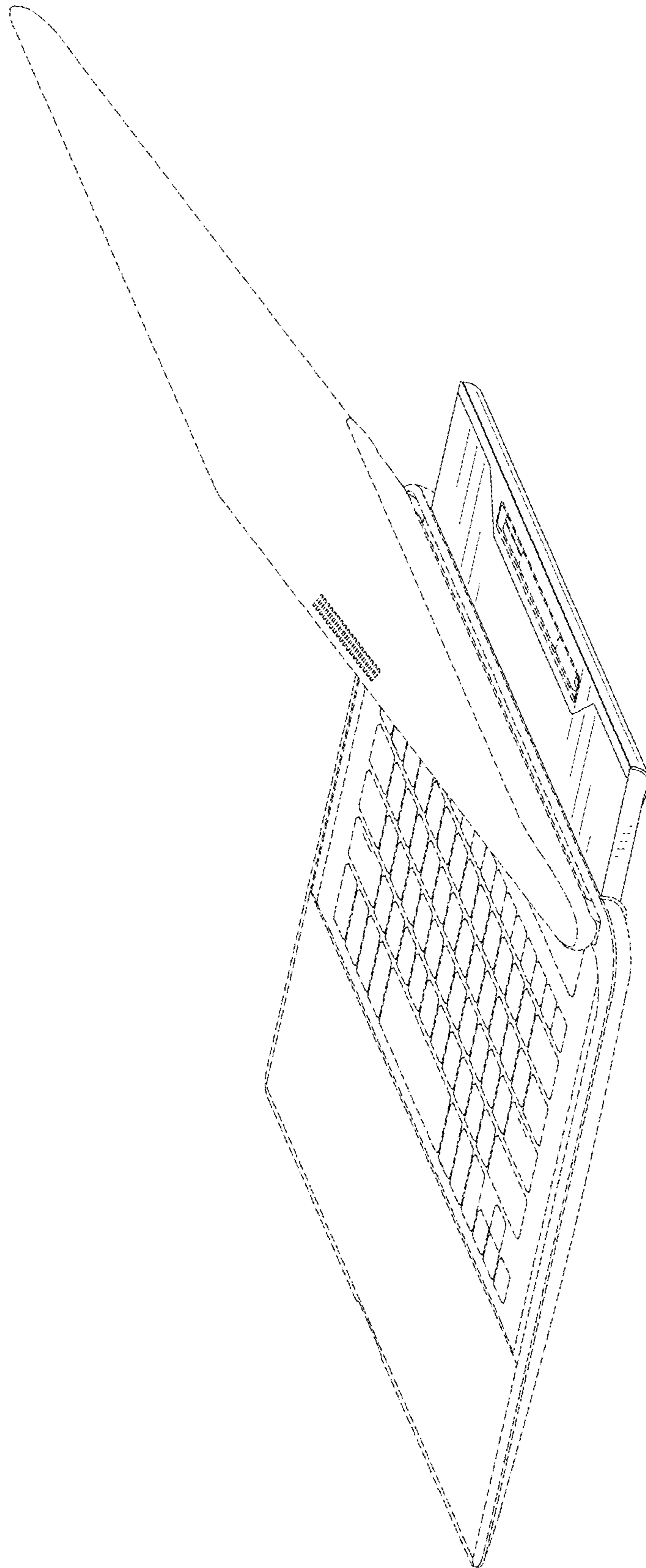

FIG. 9

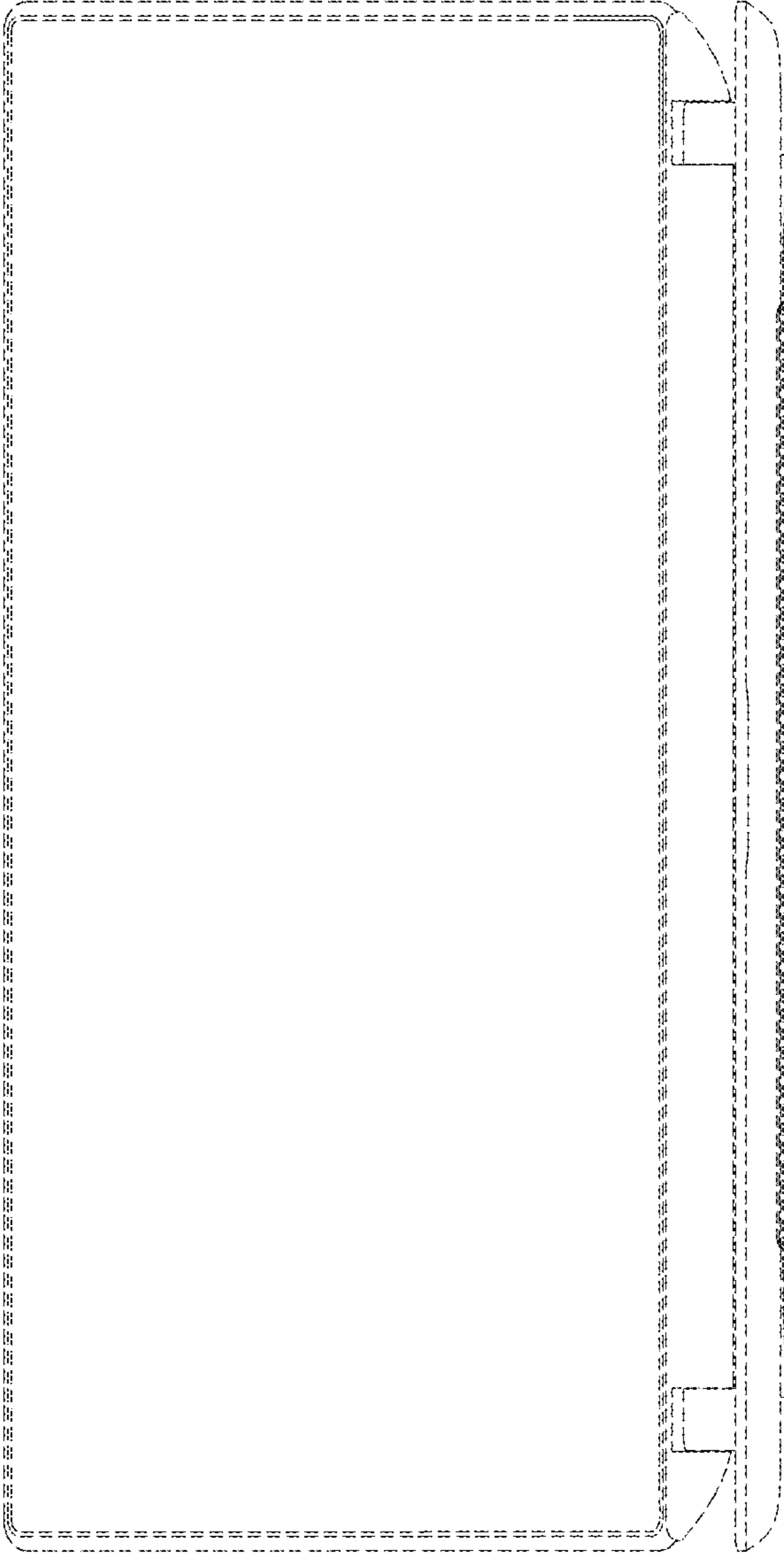

FIG. 10

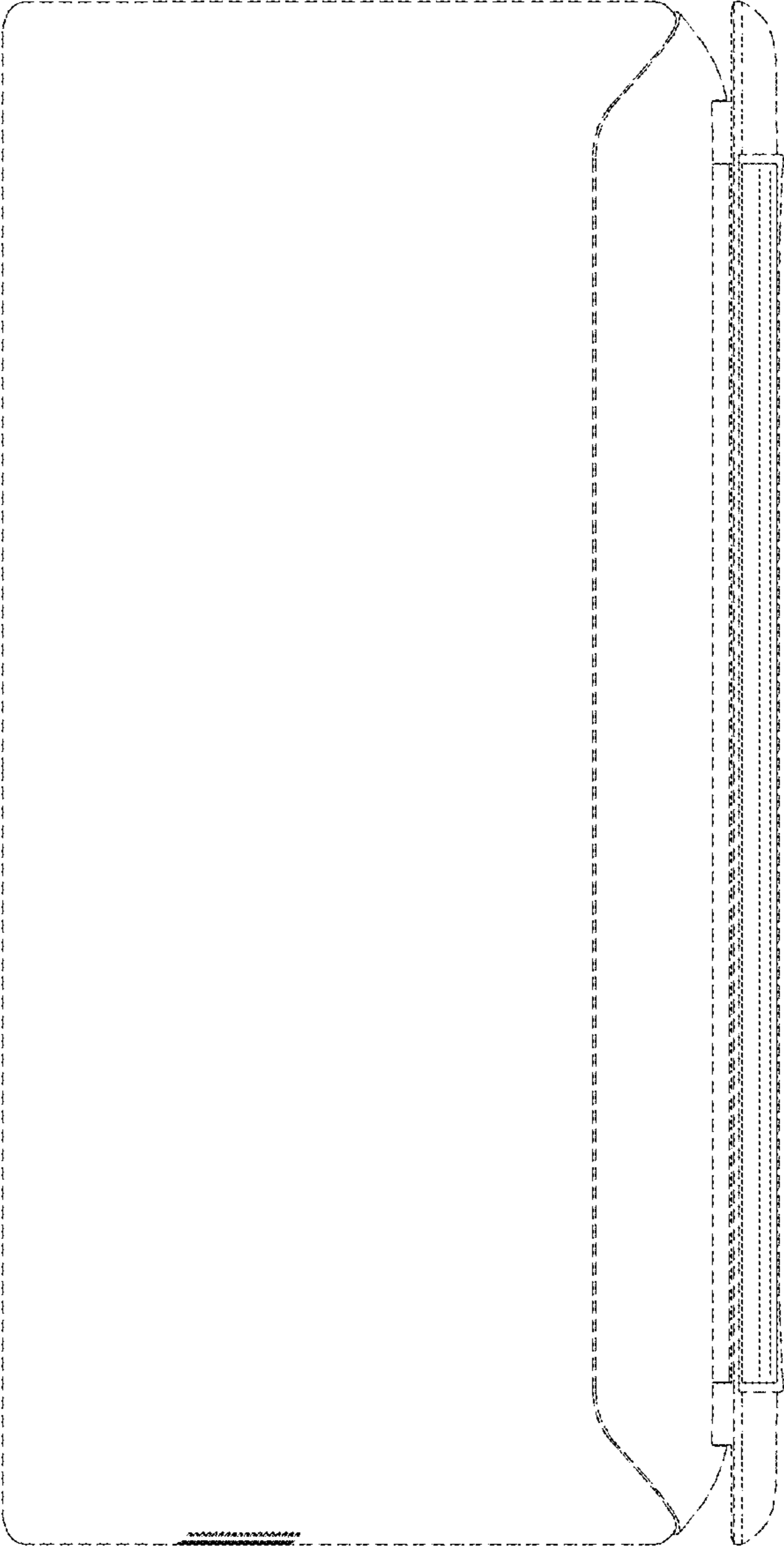

FIG. 11

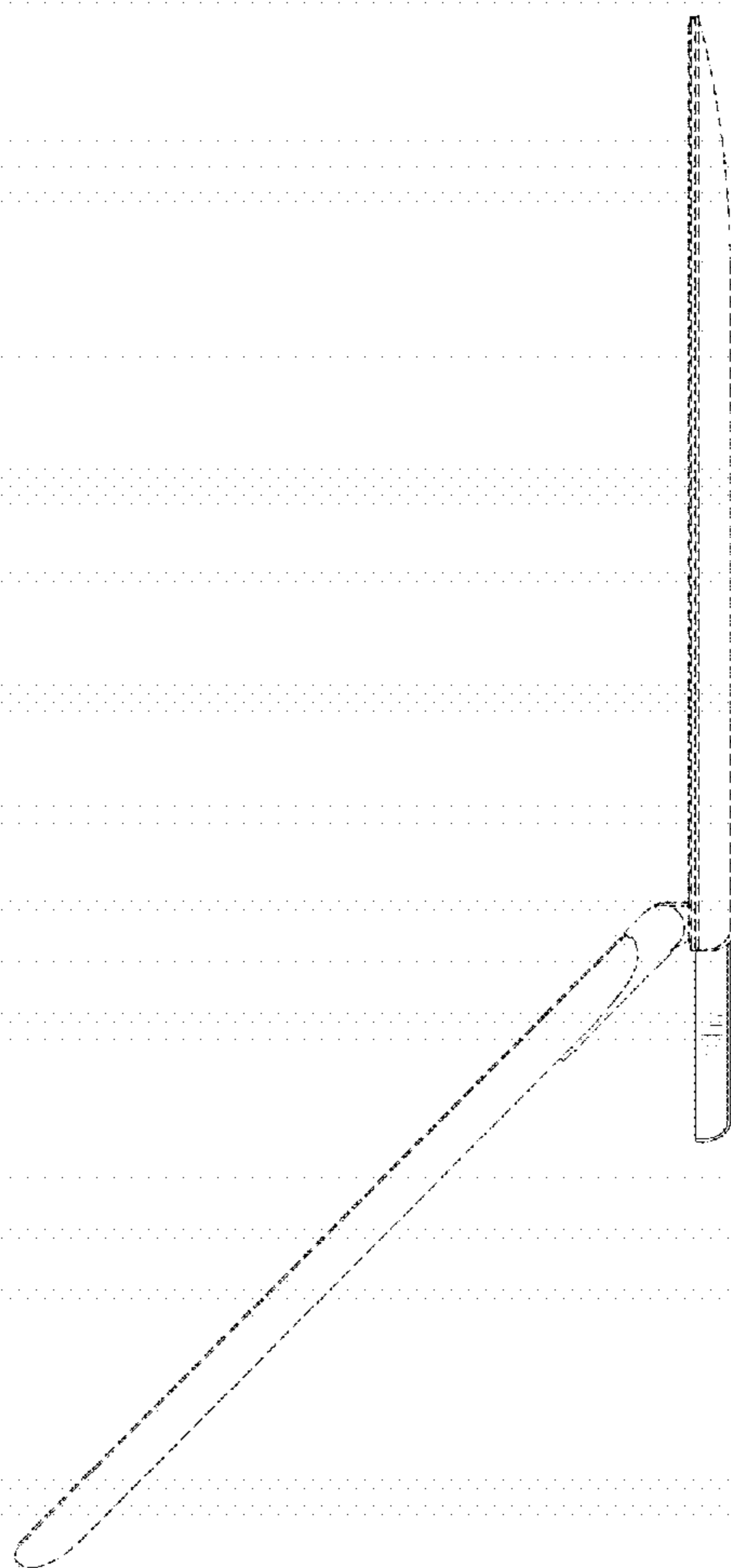

FIG. 12

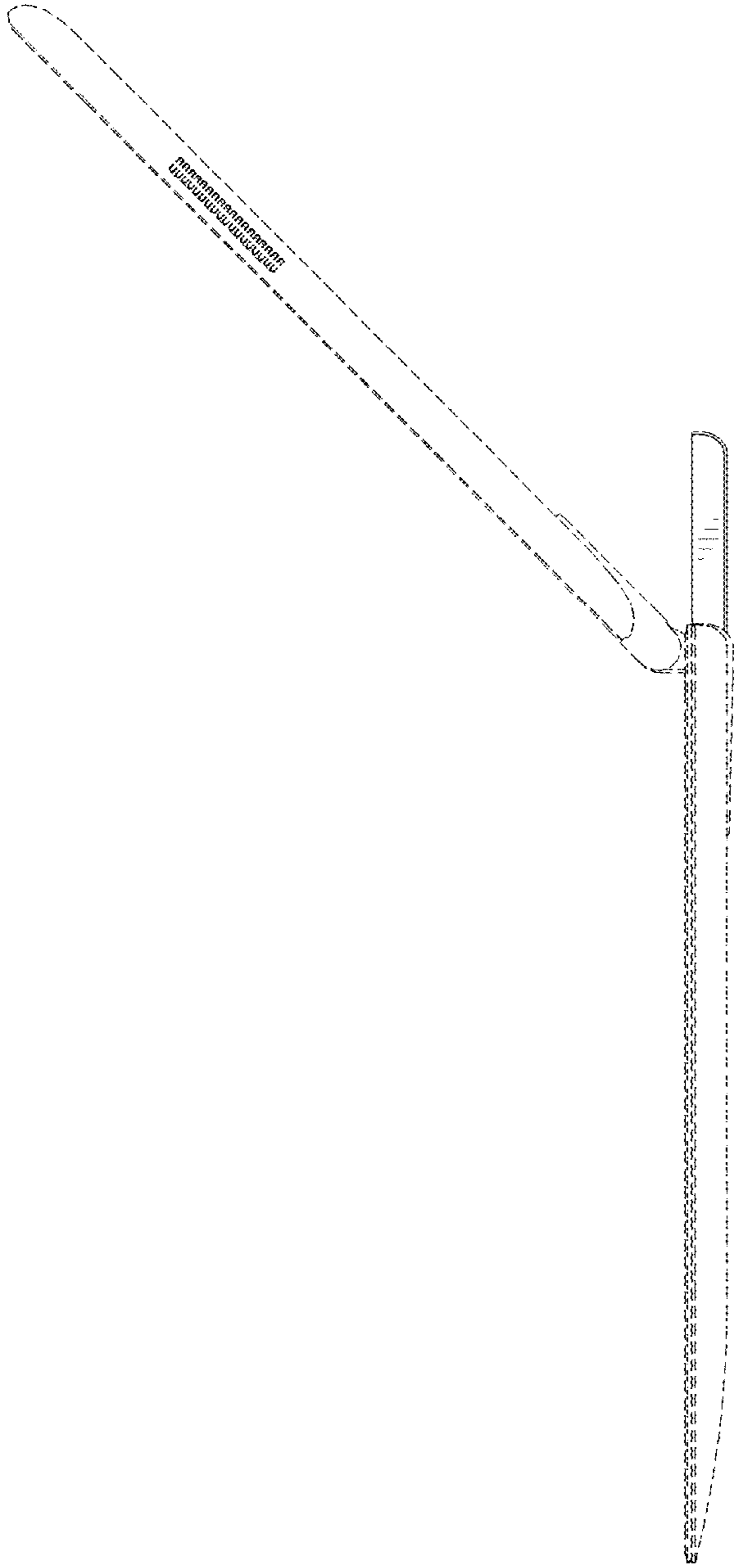

FIG. 13

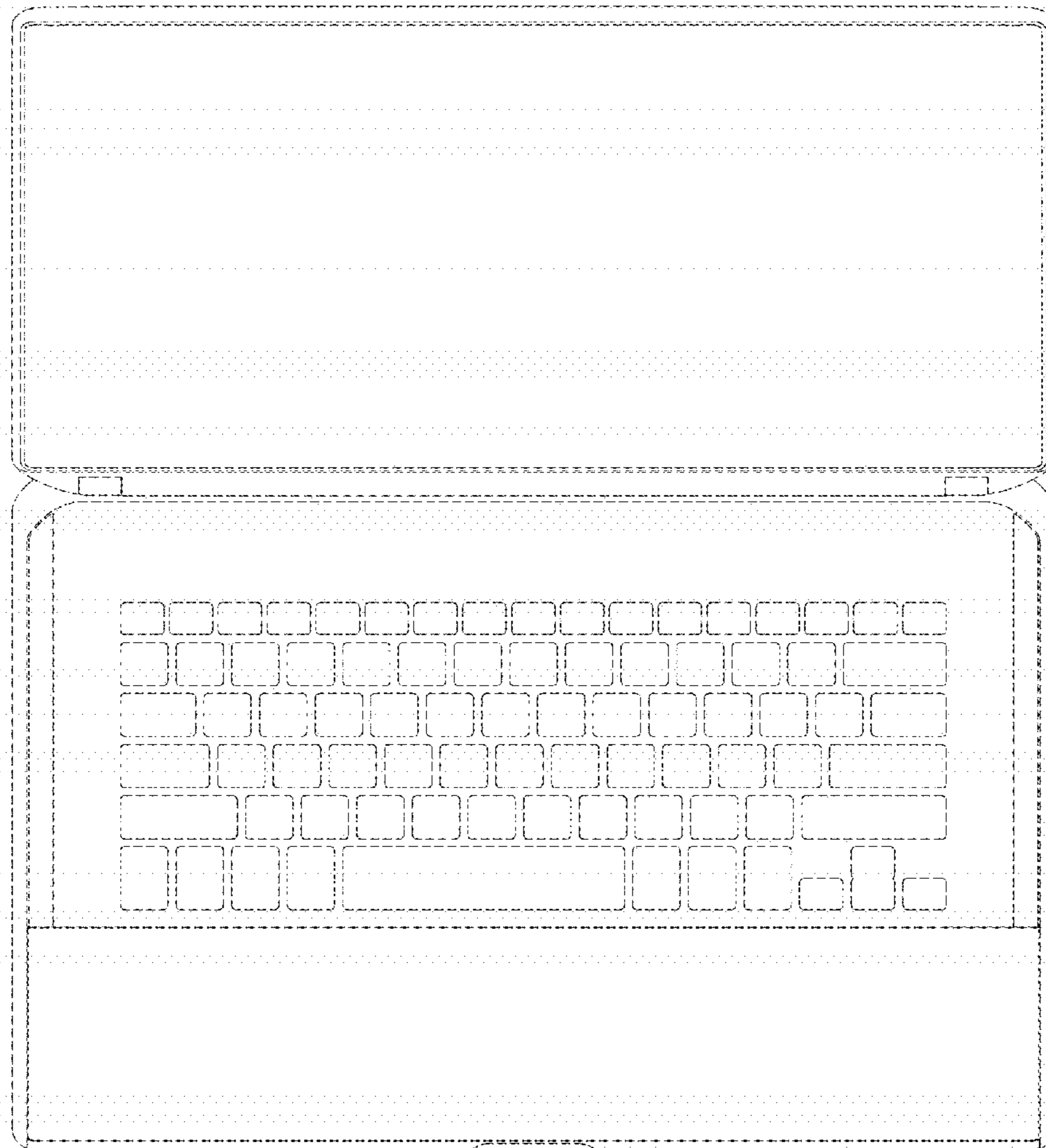

FIG. 14



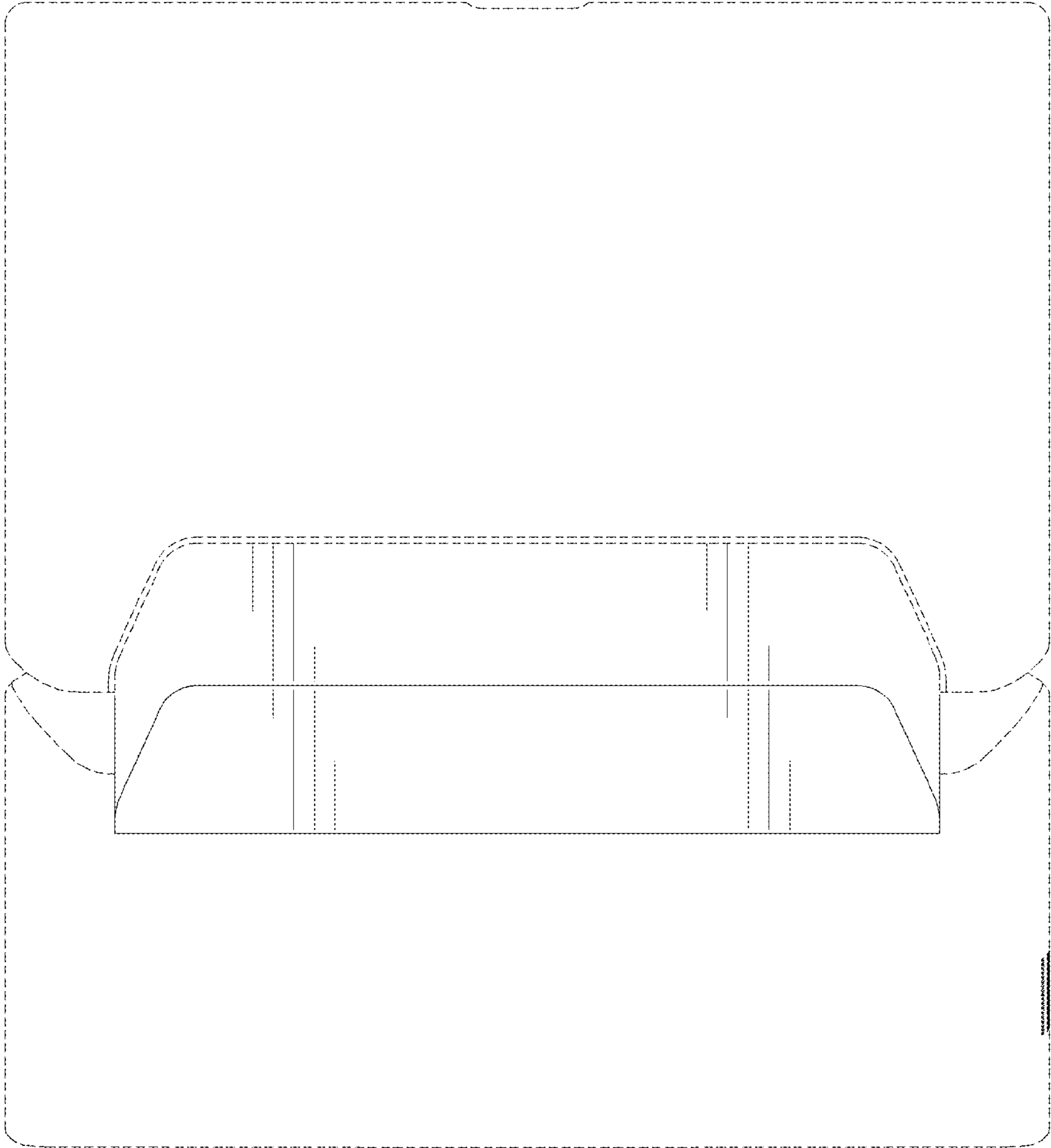

FIG. 15

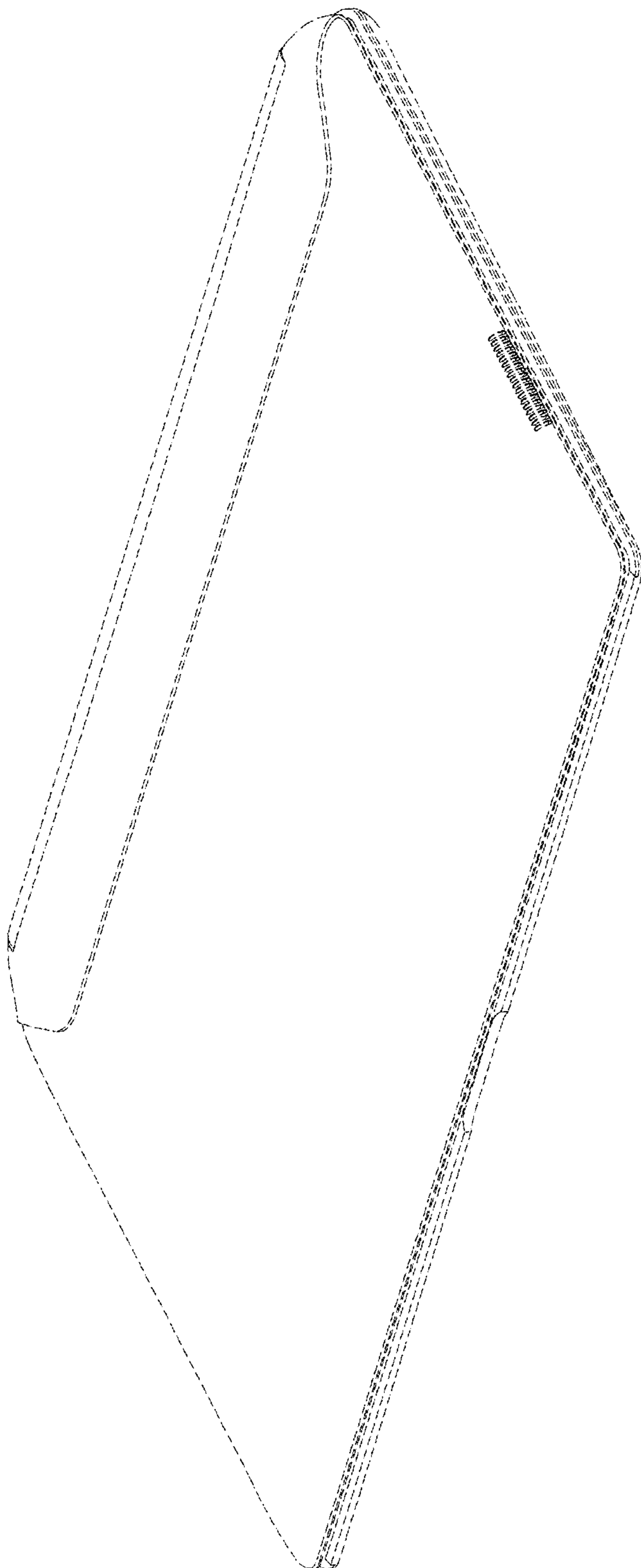

FIG. 16

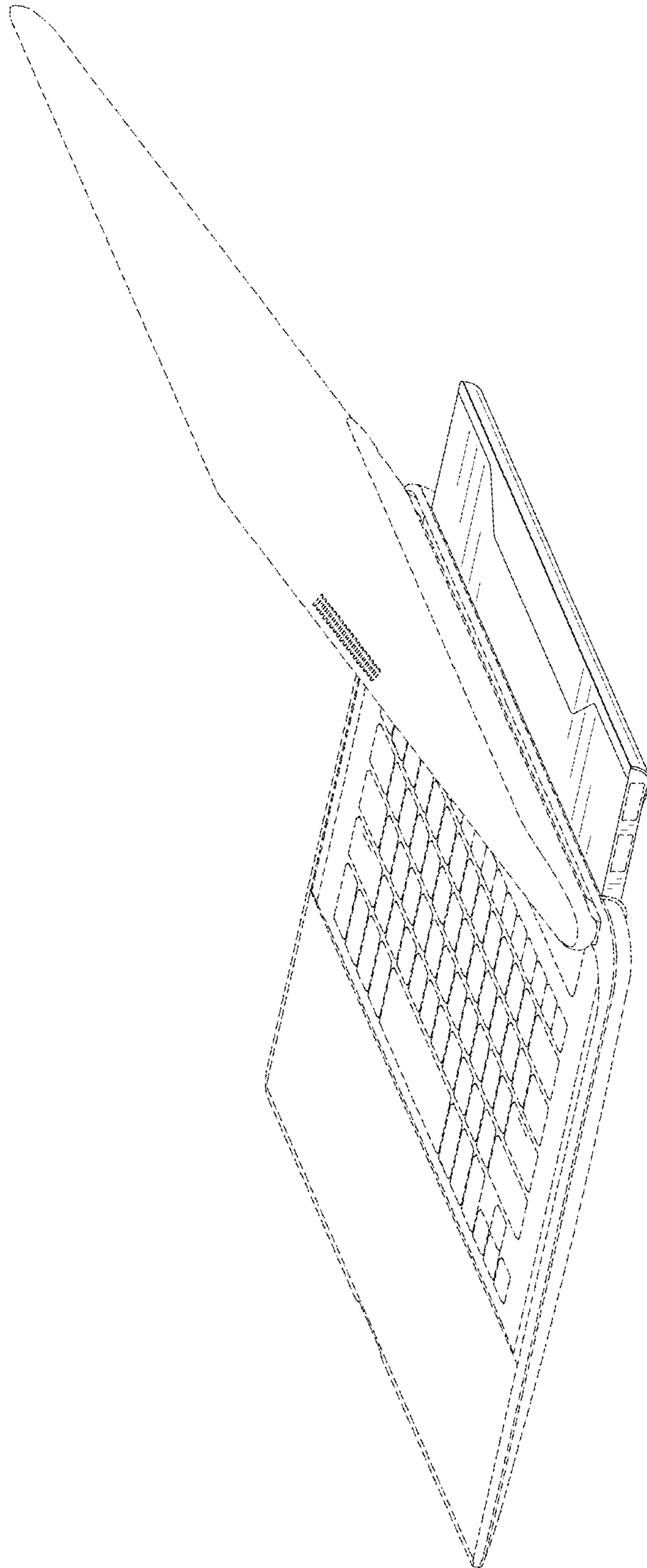

FIG. 17

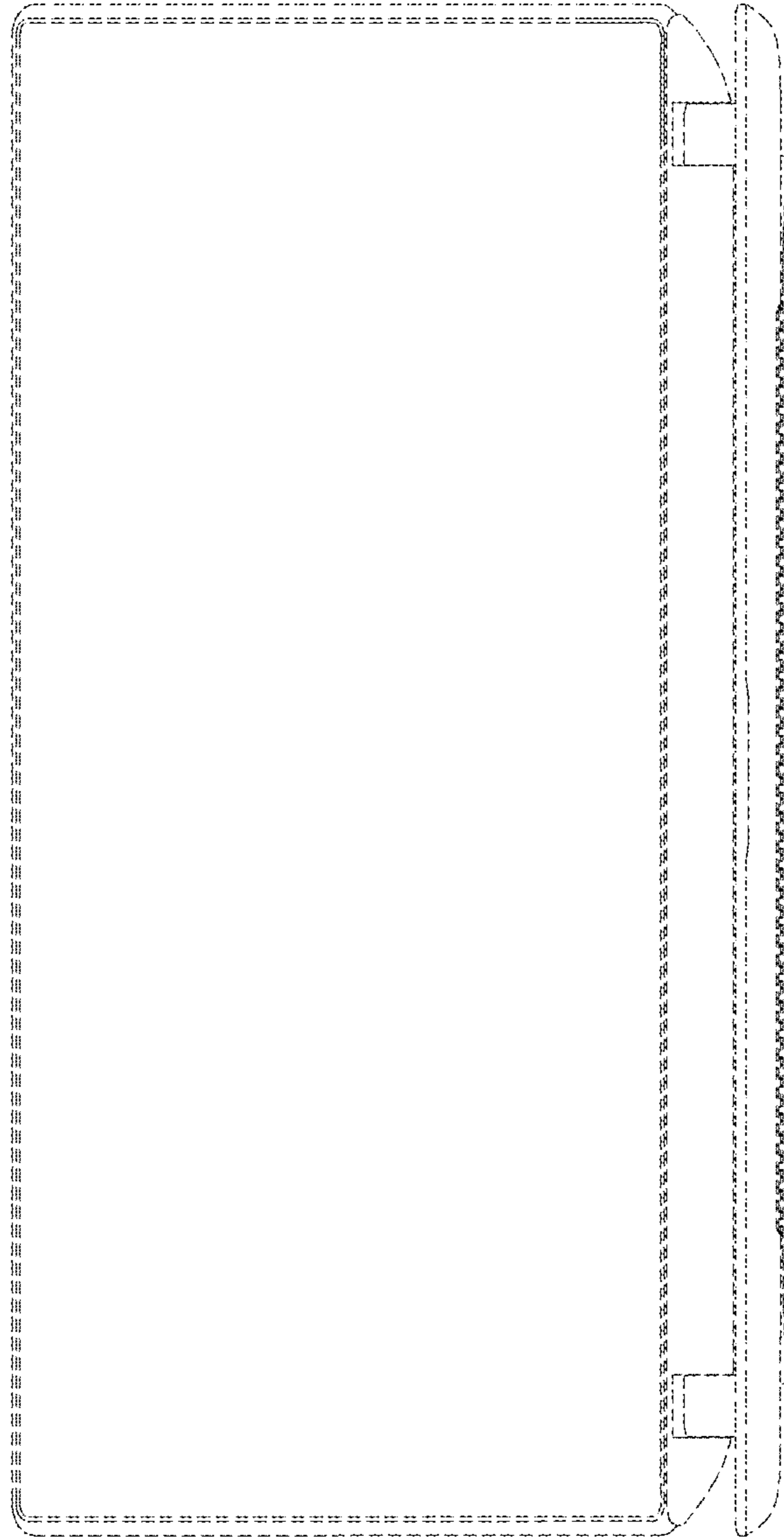

FIG. 18

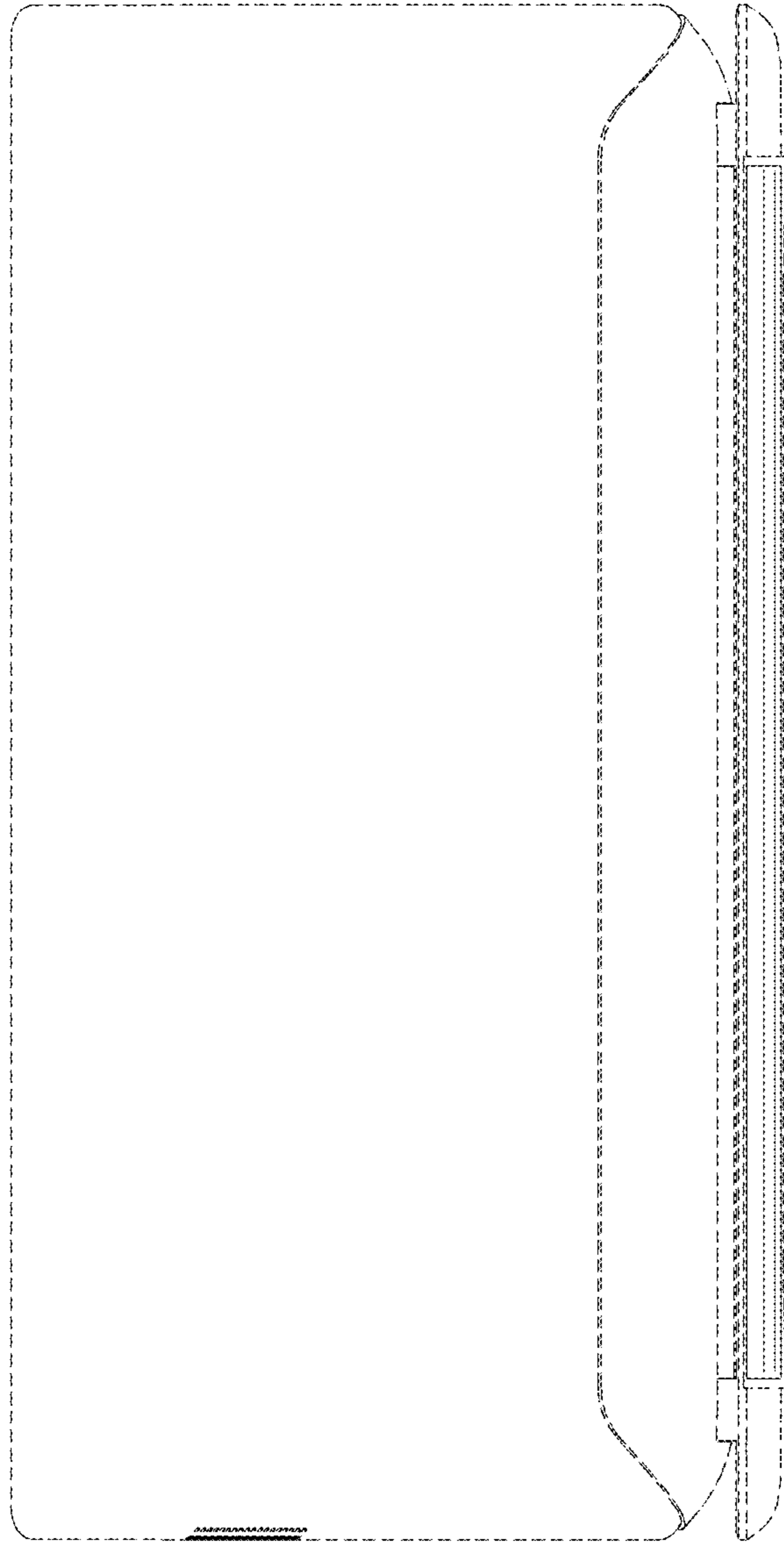

FIG. 19

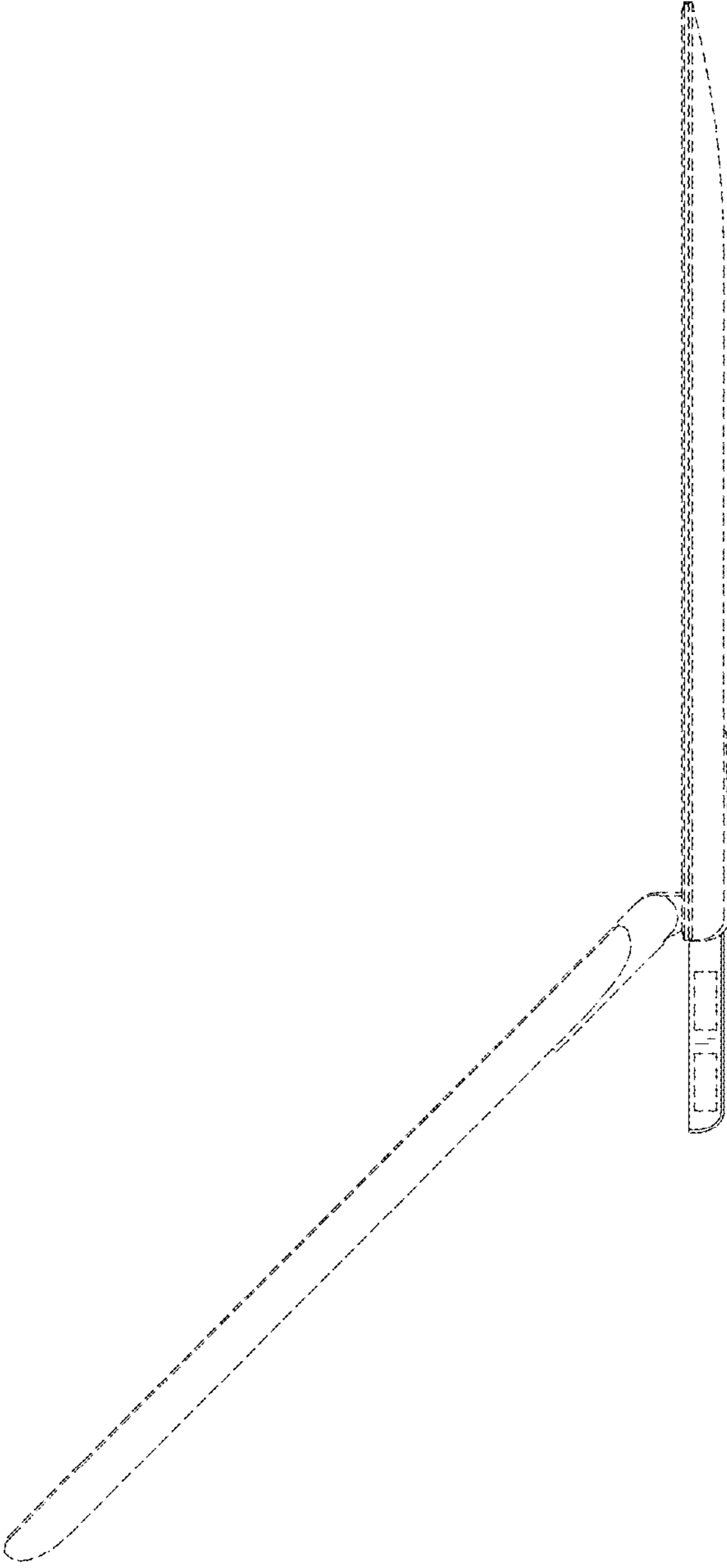

FIG. 20

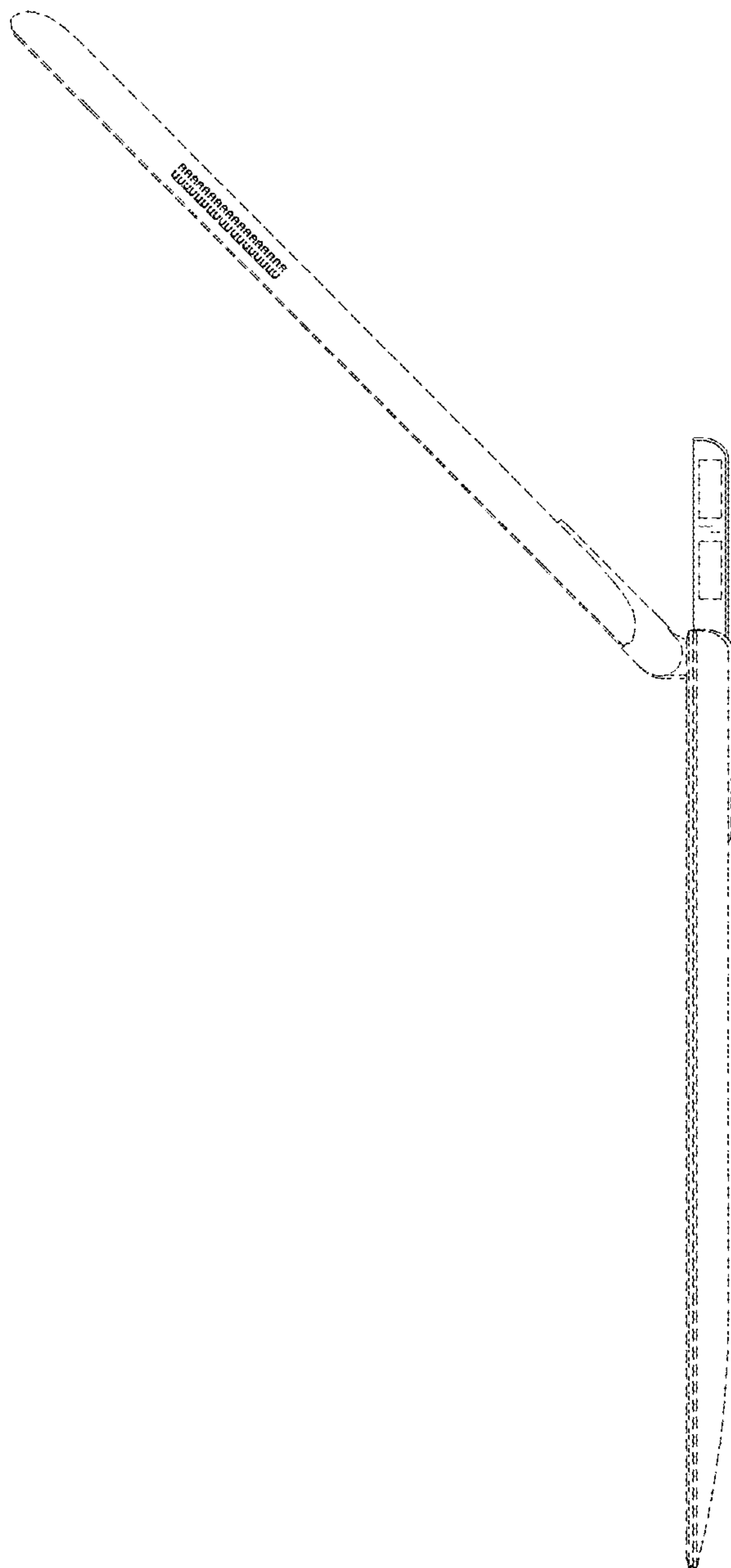

FIG. 21

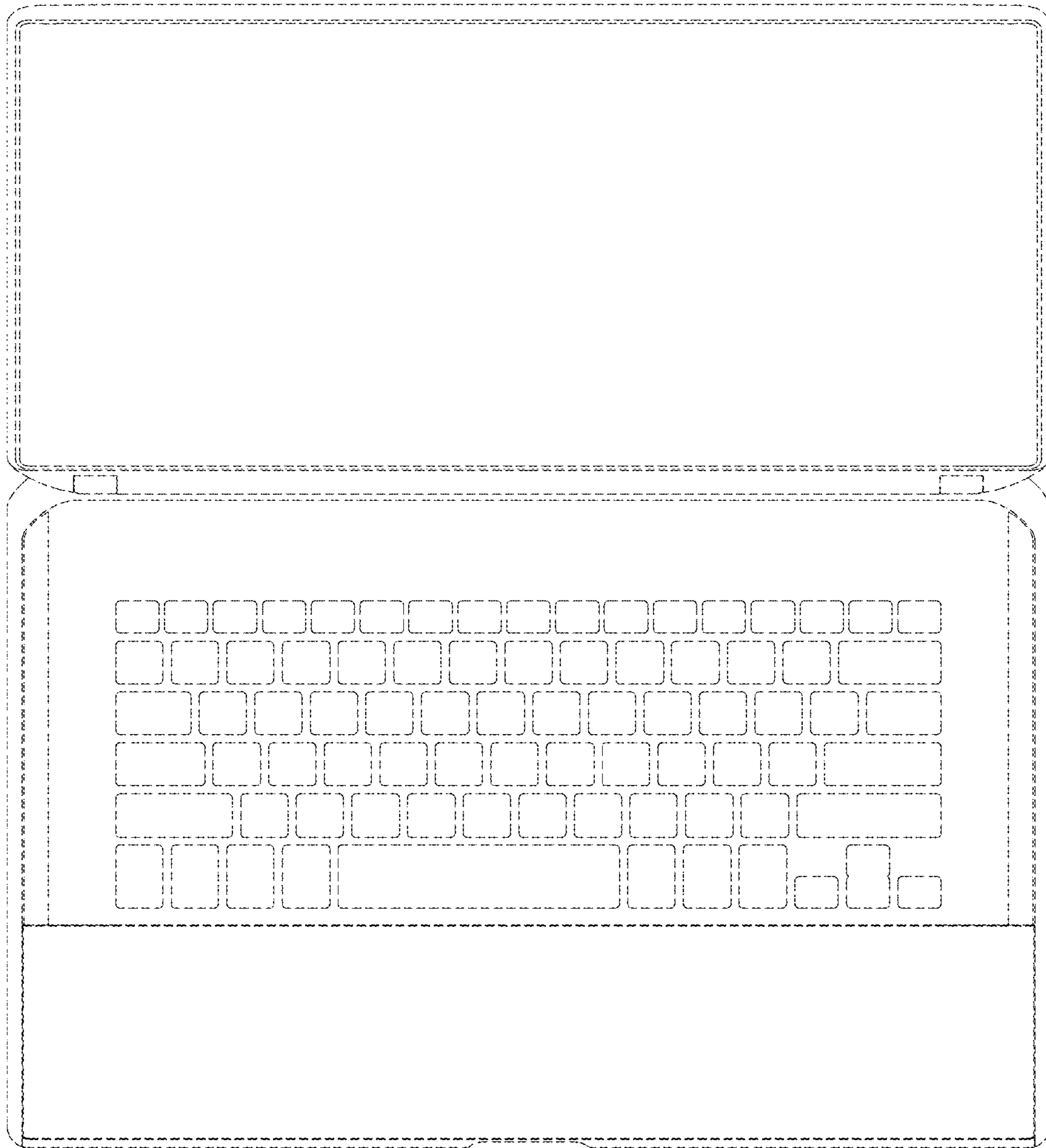

FIG. 22



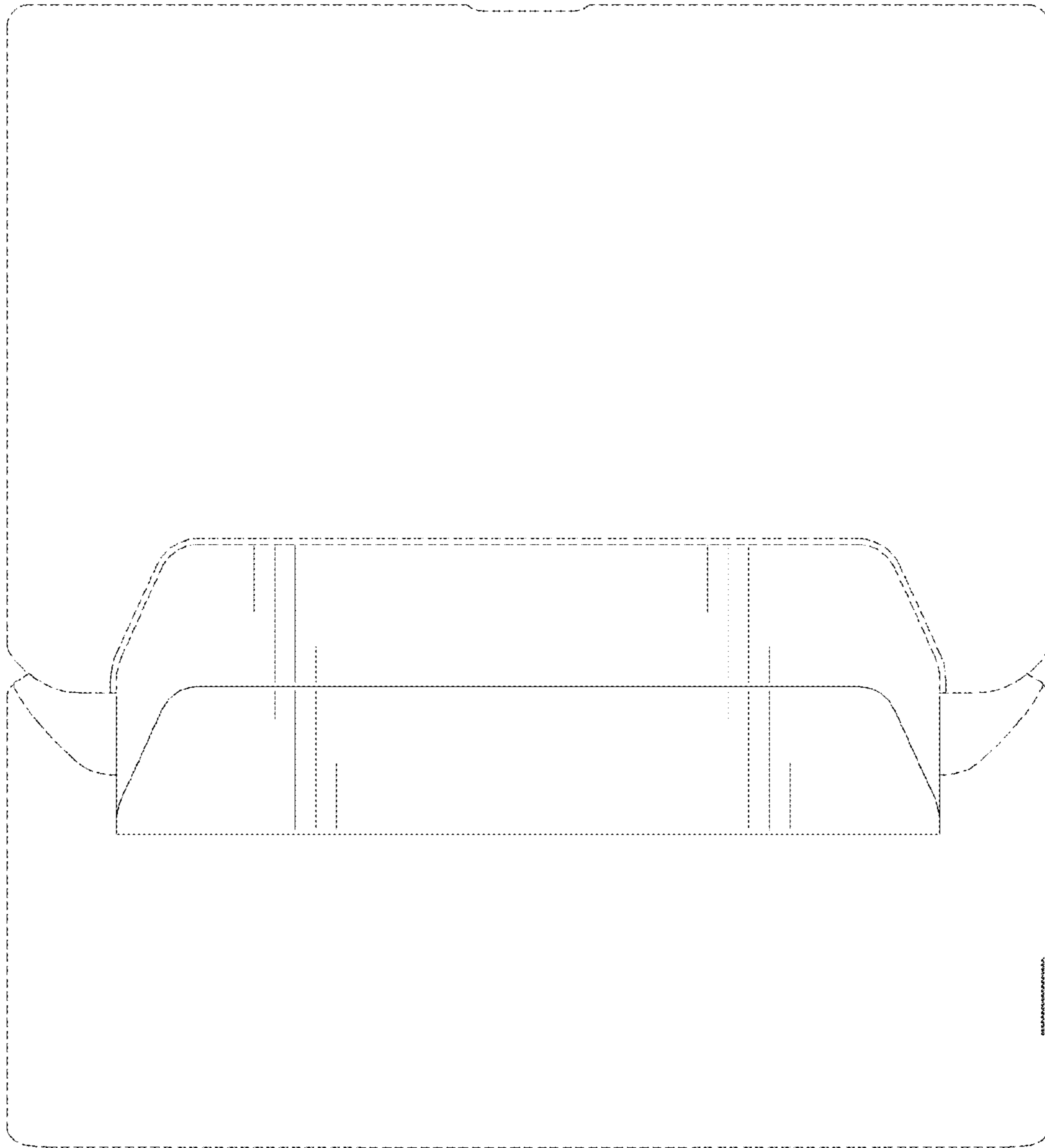

FIG. 23

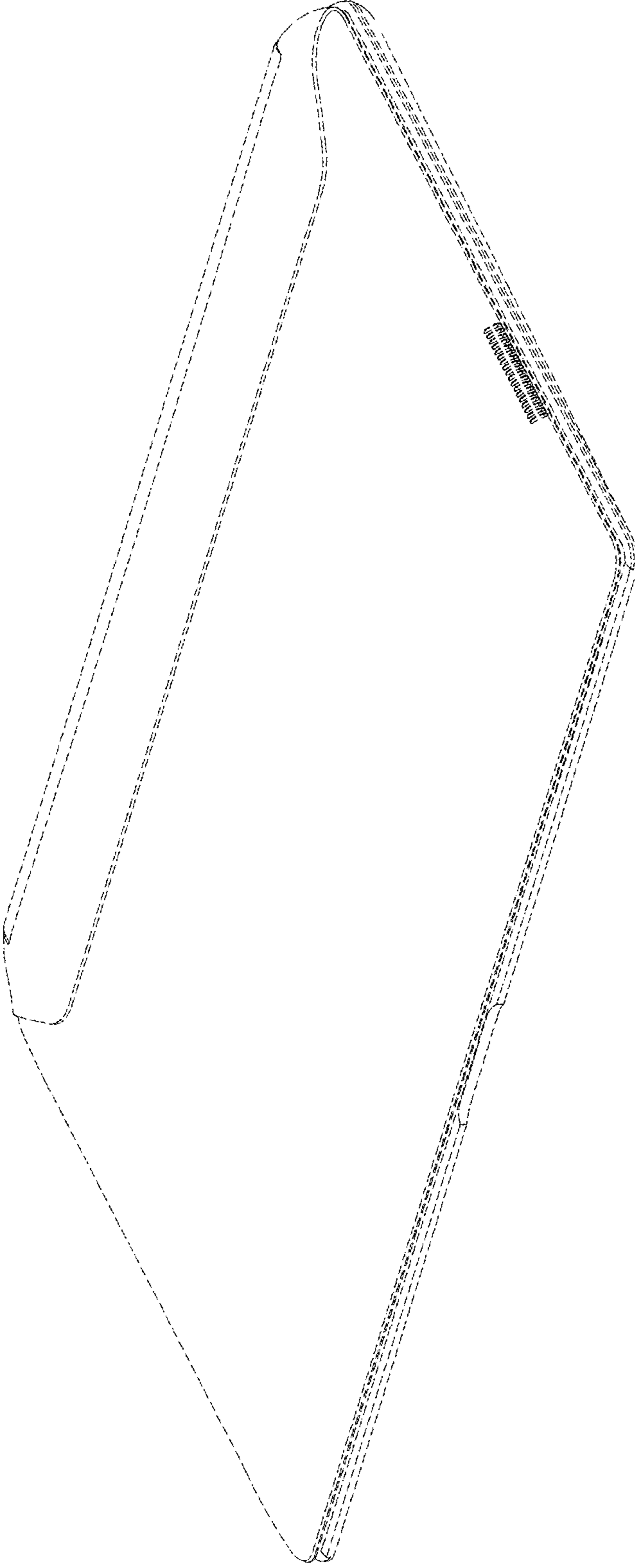

FIG. 24