



US00D684135S

(12) **United States Design Patent**  
**Seo et al.**

(10) **Patent No.:** **US D684,135 S**  
(45) **Date of Patent:** **\*\* \*Jun. 11, 2013**

(54) **CELLULAR PHONE**

(75) Inventors: **Hyunseung Seo**, Seoul (KR); **Youngho Kim**, Seoul (KR); **Jihoon Shin**, Seoul (KR)

(73) Assignee: **LG Electronics Inc.**, Seoul (KR)

(\*) Notice: This patent is subject to a terminal disclaimer.

(\*\*) Term: **14 Years**

(21) Appl. No.: **29/420,323**

(22) Filed: **May 8, 2012**

(30) **Foreign Application Priority Data**

Nov. 10, 2011 (KR) ..... 30-2011-0047418

(51) **LOC (9) Cl.** ..... **14-03**

(52) **U.S. Cl.**  
USPC ..... **D14/138 G**

(58) **Field of Classification Search**  
USPC ..... D14/138 R, 138 AD, 138 AC, 138 C, D14/138 G, 191, 203.1–203.8, 496, 138 AA, D14/138 AB, 137, 147, 218, 341–347, 247–248; D10/65, 78, 104; D13/168; D18/7; 455/566, 575.1, 575.3, 575.4

See application file for complete search history.

(56) **References Cited**

**U.S. PATENT DOCUMENTS**

- D526,301 S \* 8/2006 Shin ..... D14/138 AD
- D529,465 S \* 10/2006 Kim et al. .... D14/138 AD
- D600,690 S \* 9/2009 Miyaji ..... D14/341
- D606,506 S \* 12/2009 Choi et al. .... D14/138 AD
- D632,270 S \* 2/2011 Arnholt et al. .... D14/138 AB
- D636,364 S \* 4/2011 Sandberg ..... D14/138 G
- D640,219 S \* 6/2011 Sutherland et al. .... D14/138 G
- D643,007 S \* 8/2011 Song ..... D14/138 G
- D646,248 S \* 10/2011 Lee ..... D14/138 G
- D650,381 S \* 12/2011 Park et al. .... D14/341
- D654,049 S \* 2/2012 Chung ..... D14/138 G
- D654,893 S \* 2/2012 Jung ..... D14/138 G
- D654,894 S \* 2/2012 Kim ..... D14/138 G

- D665,765 S \* 8/2012 Oh ..... D14/138 G
- D669,054 S \* 10/2012 Han ..... D14/138 G
- D669,444 S \* 10/2012 Shin et al. .... D14/138 G
- D671,089 S \* 11/2012 Joung et al. .... D14/138 G
- D676,822 S \* 2/2013 Seo et al. .... D14/138 G
- 2003/0125094 A1 \* 7/2003 Hyun et al. .... 455/566
- 2007/0232368 A1 \* 10/2007 Feightner et al. .... 455/575.1
- 2010/0207903 A1 \* 8/2010 Kim et al. .... 345/173
- 2011/0195762 A1 \* 8/2011 Noh et al. .... 455/575.4
- 2011/0237274 A1 \* 9/2011 Wong et al. .... 455/456.1
- 2012/0309464 A1 \* 12/2012 Lim et al. .... 455/566
- 2012/0322464 A1 \* 12/2012 Chun ..... 455/456.3

**FOREIGN PATENT DOCUMENTS**

CN RGN 302299417 \* 1/2013

**OTHER PUBLICATIONS**

Icemobile Galaxy Prime, announced 2012, [online], [retrieved on May 10, 2012]. Retrieved from Internet ,<URL: <http://www.gsmarena.com>>.\*

LG Motion 4G MS770, announced Aug. 2012, [online], [retrieved on Sep. 12, 2012]. Retrieved from Internet ,<URL: <http://www.gsmarena.com>>.\*

Samsung C3300K Champ, announced May 2010, [online], [retrieved on Jun. 11, 2010]. Retrieved from Internet ,<URL: <http://www.gsmarena.com>>.\*

T-Mobile myTouch Q, announced Oct. 2011, [online], [retrieved on Oct. 11, 2011]. Retrieved from Internet ,<URL: <http://www.gsmarena.com>>.\*

\* cited by examiner

*Primary Examiner* — Bridget L Eland

(74) *Attorney, Agent, or Firm* — Morgan, Lewis & Bockius LLP

(57) **CLAIM**

The ornamental design for a cellular phone, as shown and described.

**DESCRIPTION**

FIG. 1 is a front, right side, perspective view of a cellular phone showing our new design;  
FIG. 2 is a front view thereof;  
FIG. 3 is a rear view thereof;  
FIG. 4 is a left side view thereof;  
FIG. 5 is a right side view thereof;  
FIG. 6 is a top view thereof; and,  
FIG. 7 is a bottom view thereof.

**1 Claim, 6 Drawing Sheets**

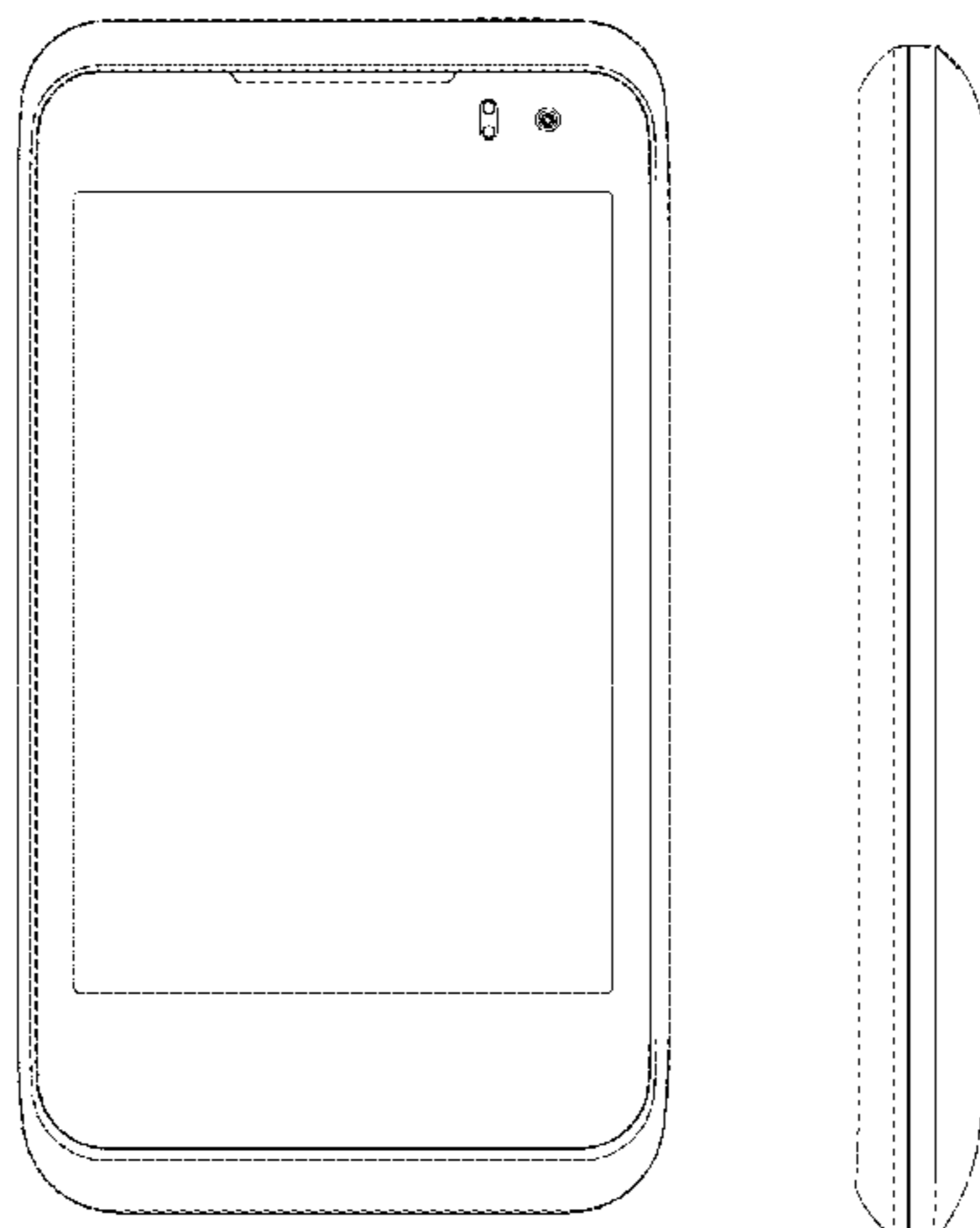

FIG. 1

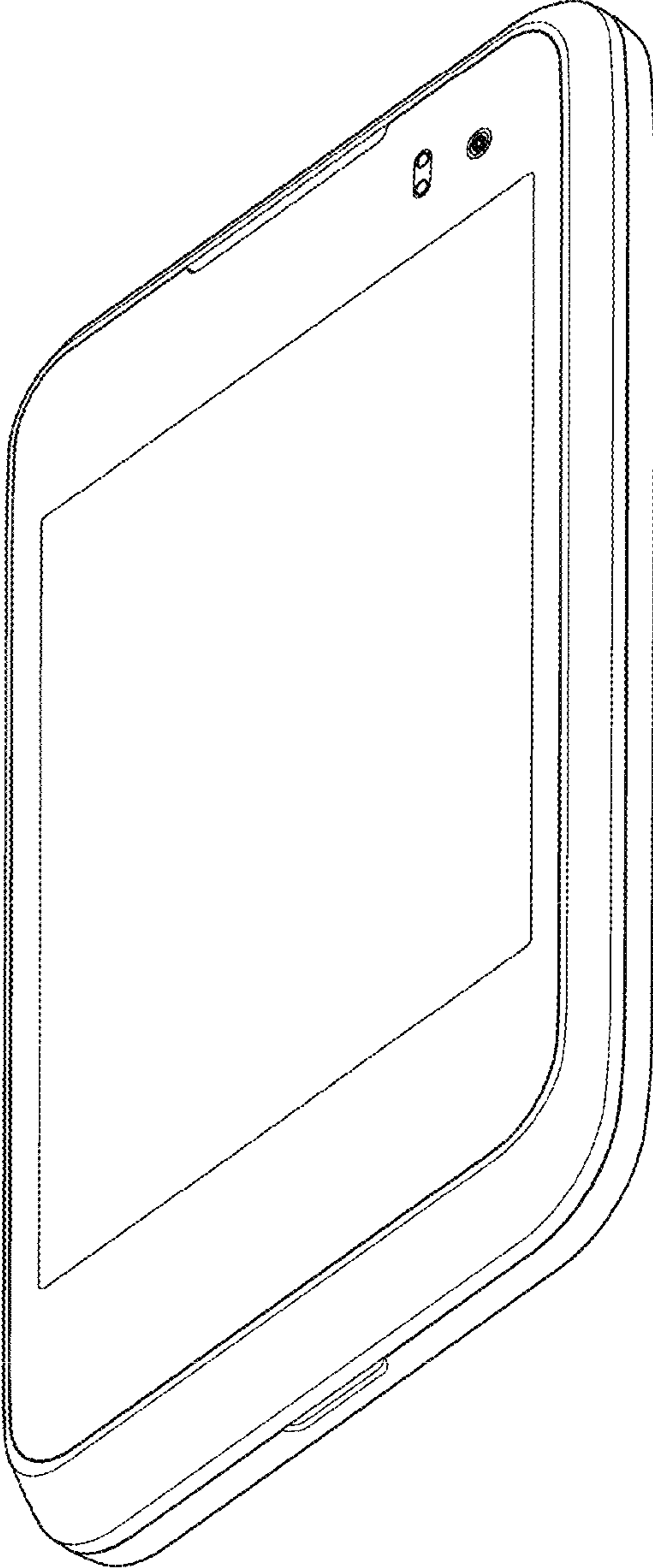

FIG. 2

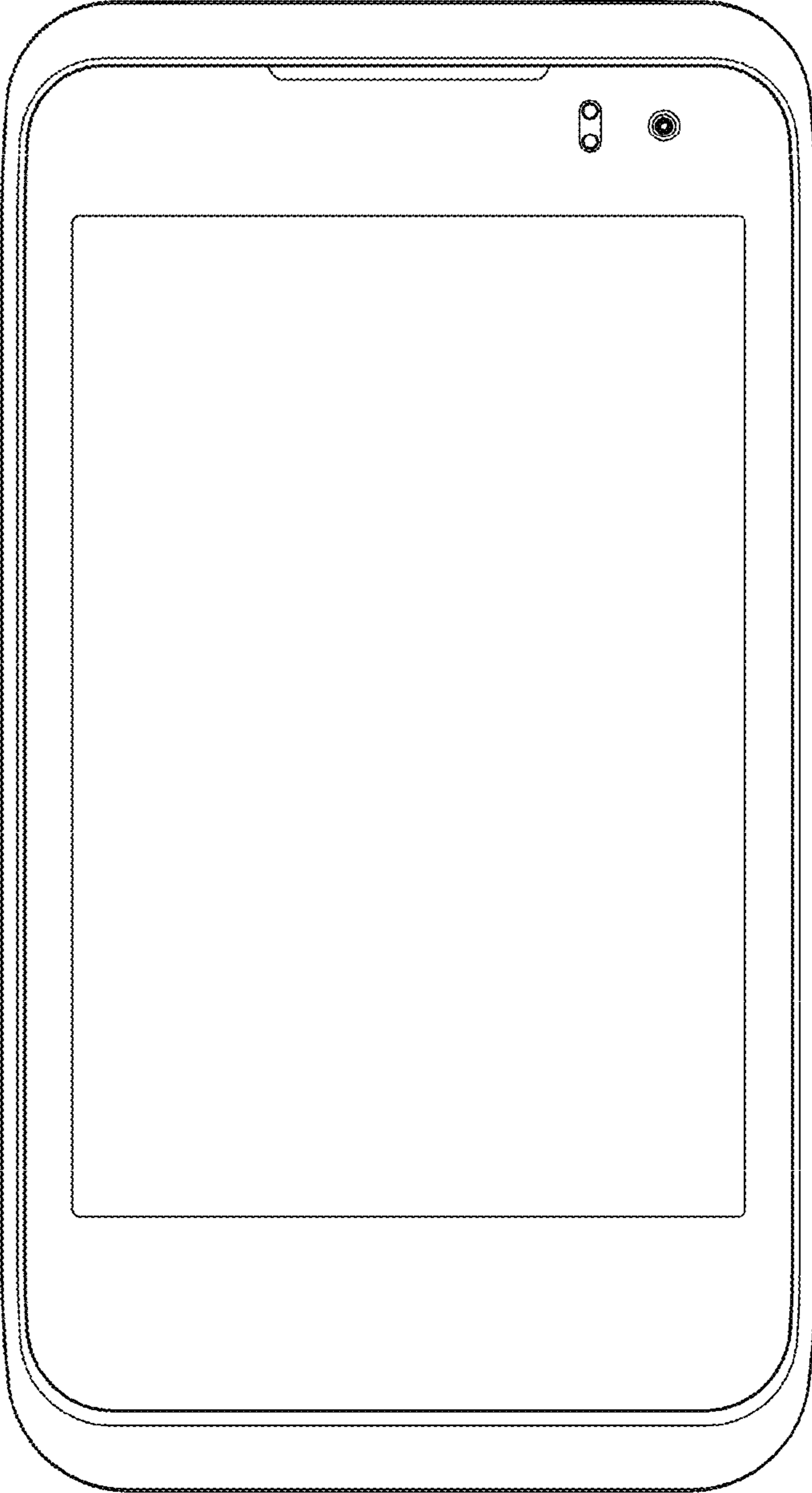

FIG. 3

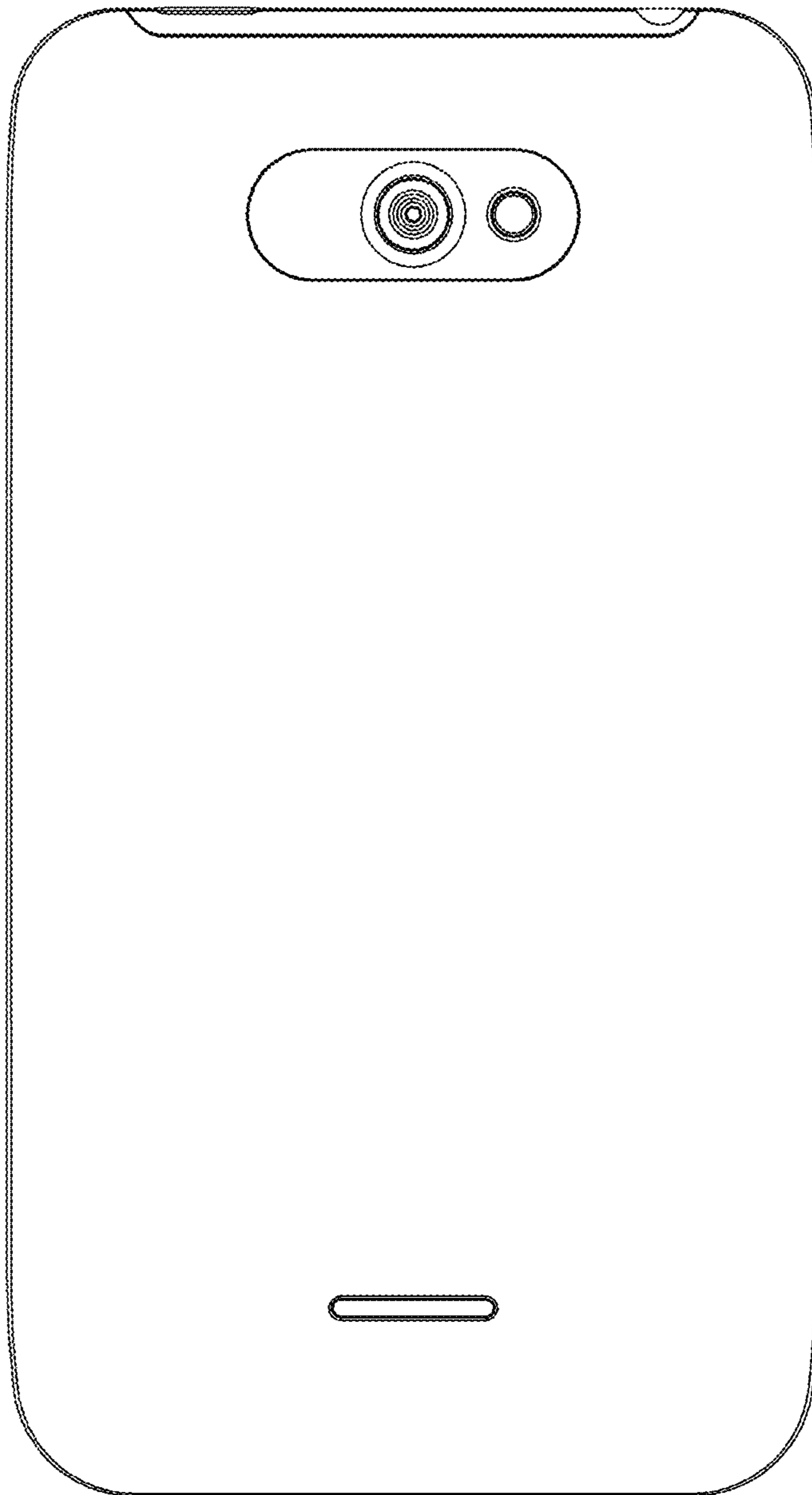

FIG. 4

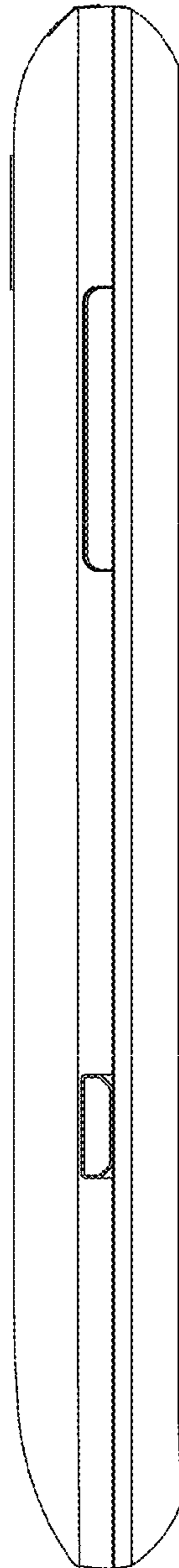

FIG. 5

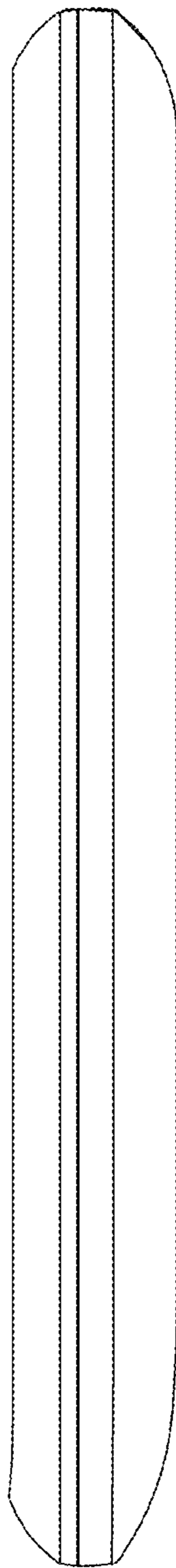

FIG. 6

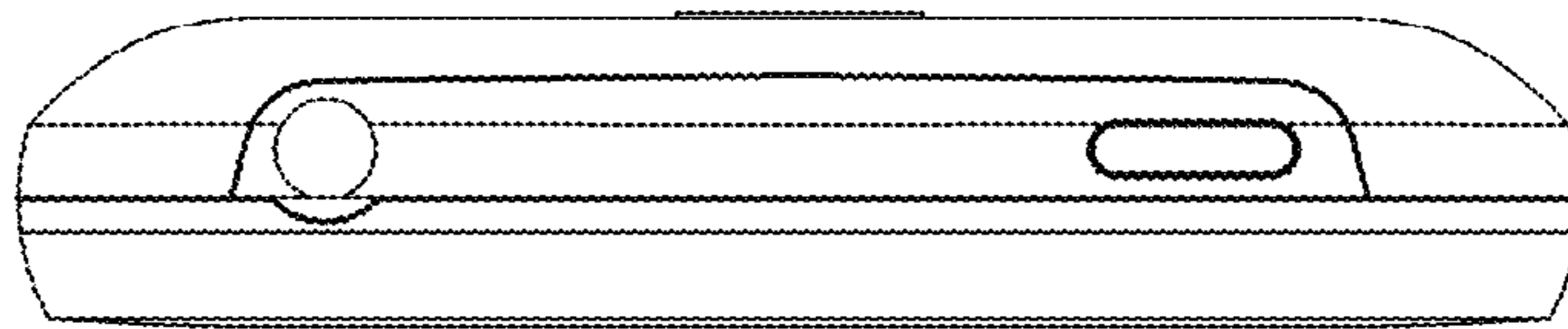

FIG. 7

