



US00D683827S

(12) **United States Design Patent**
Ealer, Sr.

(10) **Patent No.:** **US D683,827 S**
(45) **Date of Patent:** **** Jun. 4, 2013**

(54) **GUTTER COVER**

(76) Inventor: **James Edward Ealer, Sr., St. Clair, MO (US)**

(**) Term: **14 Years**

(21) Appl. No.: **29/386,313**

(22) Filed: **Feb. 28, 2011**

Related U.S. Application Data

(63) Continuation of application No. 29/358,644, filed on Mar. 30, 2010, now abandoned.

(51) **LOC (9) Cl.** **23-01**

(52) **U.S. Cl.**
USPC **D23/267**

(58) **Field of Classification Search**
USPC D23/259-269; 52/11-12, 73.21,
52/302.3; 248/48.1-48.2
See application file for complete search history.

(56) **References Cited**

U.S. PATENT DOCUMENTS

5,010,696 A 4/1991 Knittel
5,072,551 A 12/1991 Manoogian, Jr.

(Continued)

Primary Examiner — Eric Goodman

(74) *Attorney, Agent, or Firm* — Senniger Powers LLP

(57) **CLAIM**

The ornamental design for a gutter cover, as shown and described.

DESCRIPTION

FIG. 1 is a top front perspective view of a first embodiment of a gutter cover of my design.

FIG. 2 is a front view of the gutter cover.

FIG. 3 is a top view of the gutter cover.

FIG. 4 is a right end view of the gutter cover.

FIG. 5 is a rear view of the gutter cover.

FIG. 6 is a bottom view of the gutter cover.

FIG. 7 is a left end view of the gutter cover.

FIG. 8 is a top front perspective view of a second embodiment of a gutter cover of my design.

FIG. 9 is a front view of the gutter cover of FIG. 8.

FIG. 10 is a top view of the gutter cover of FIG. 8.

FIG. 11 is a right end view of the gutter cover of FIG. 8.

FIG. 12 is a rear view of the gutter cover of FIG. 8.

FIG. 13 is a bottom view of the gutter cover of FIG. 8.

FIG. 14 is a left end view of the gutter cover of FIG. 8.

FIG. 15 is a top front perspective view of a third embodiment of a gutter cover of my design.

FIG. 16 is a front view of the gutter cover of FIG. 15.

FIG. 17 is a top view of the gutter cover of FIG. 15.

FIG. 18 is a right end view of the gutter cover of FIG. 15.

FIG. 19 is a rear view of the gutter cover of FIG. 15.

FIG. 20 is a bottom view of the gutter cover of FIG. 15.

FIG. 21 is a left end view of the gutter cover of FIG. 15.

FIG. 22 is a top front perspective view of a fourth embodiment of a gutter cover of my design.

FIG. 23 is a front view of the gutter cover of FIG. 22.

FIG. 24 is a top view of the gutter cover of FIG. 22.

FIG. 25 is a right end view of the gutter cover of FIG. 22.

FIG. 26 is a rear view of the gutter cover of FIG. 22.

FIG. 27 is a bottom view of the gutter cover of FIG. 22; and,

FIG. 28 is a left end view of the gutter cover of FIG. 22.

The broken line showing is included for the purpose of illustrating portions of the article and forms no part of the claimed design.

1 Claim, 28 Drawing Sheets

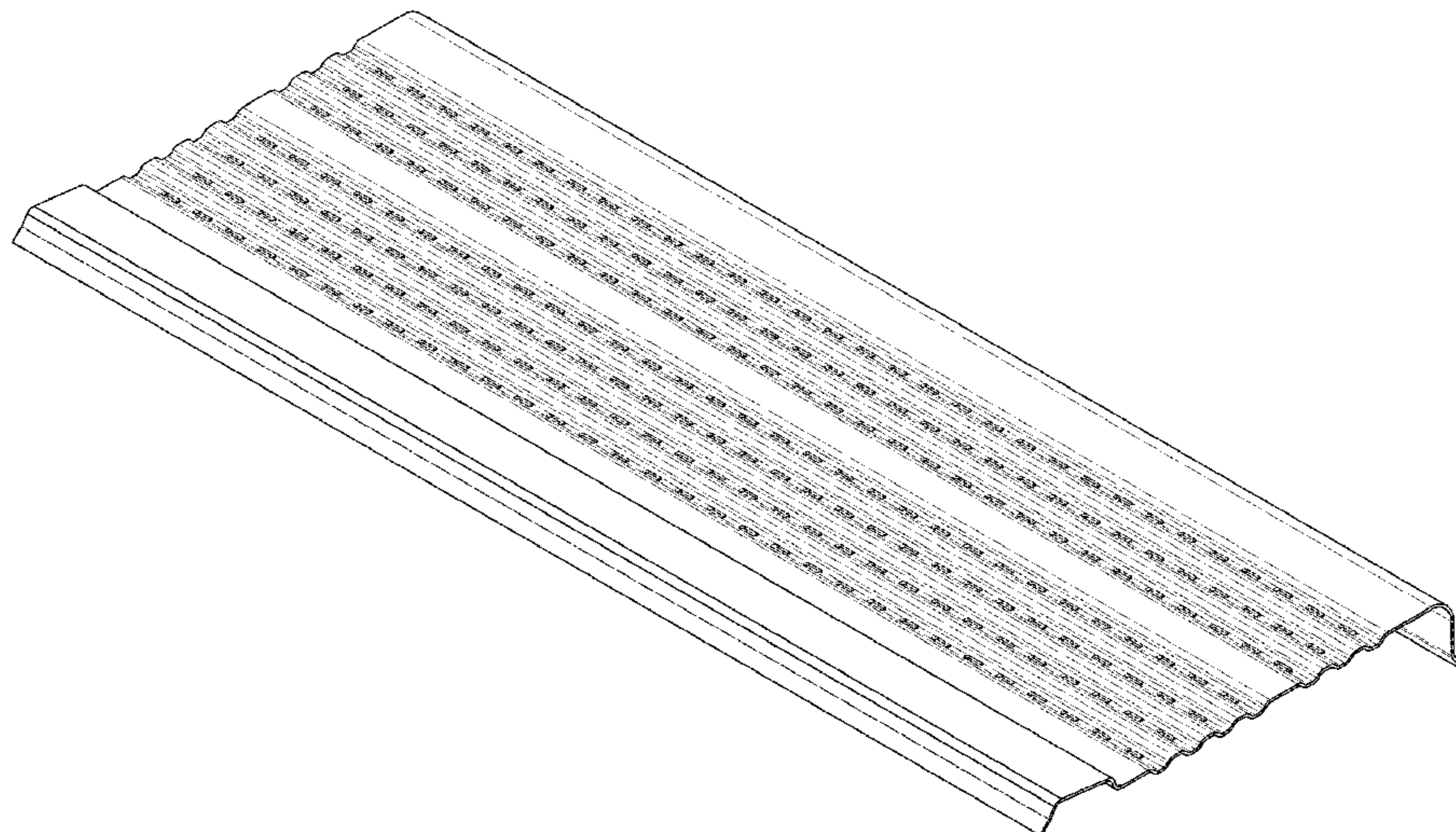

US D683,827 S

Page 2

U.S. PATENT DOCUMENTS										
5,271,192	A	12/1993	Nothum	D638,920	S	*	5/2011	Ealer, Sr.	D23/267
5,619,825	A	4/1997	Leroney	8,322,082	B2	*	12/2012	Neumann	52/12
6,516,577	B2	2/2003	Pelfrey	2006/0201068	A1		9/2006	Shane		
6,941,707	B2	9/2005	Sigmund	2008/0127575	A1		6/2008	Ealer		
6,968,651	B2	11/2005	Bergeron	2010/0071273	A1		3/2010	Joly, Jr.		
D523,538	S	6/2006	Brochu	2010/0287846	A1	*	11/2010	Lenney	52/12
7,143,549	B2	12/2006	Brochu	2011/0138697	A1	*	6/2011	Martin	52/12
7,191,564	B2	3/2007	Higginbotham	2011/0138698	A1	*	6/2011	Neumann	52/12
7,310,912	B2	12/2007	Lenney	2011/0185641	A1	*	8/2011	Snell	52/12
7,913,458	B2	3/2011	Higginbotham	2012/0272586	A1	*	11/2012	Beck et al.	52/12
									

* cited by examiner

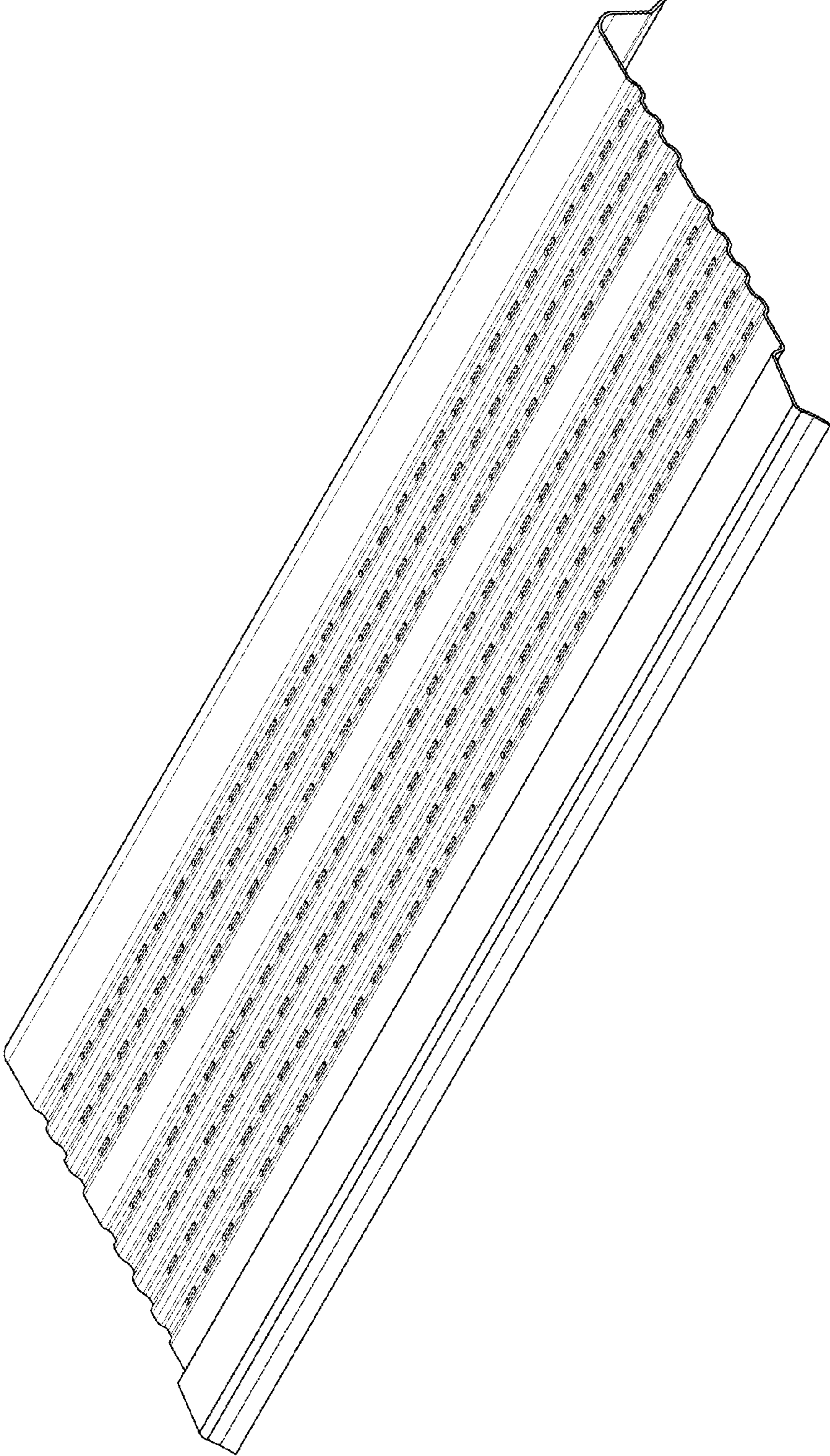

FIG. 1

FIG. 2

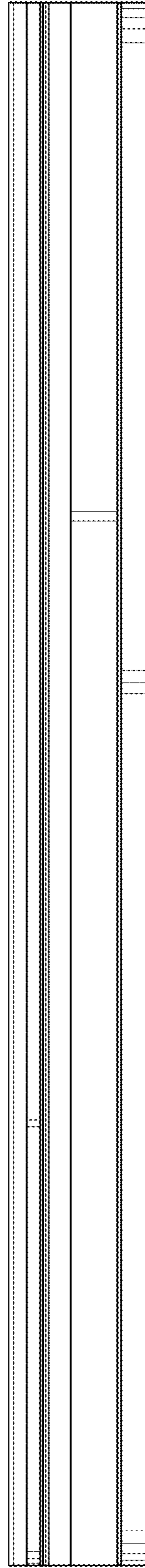

FIG. 3

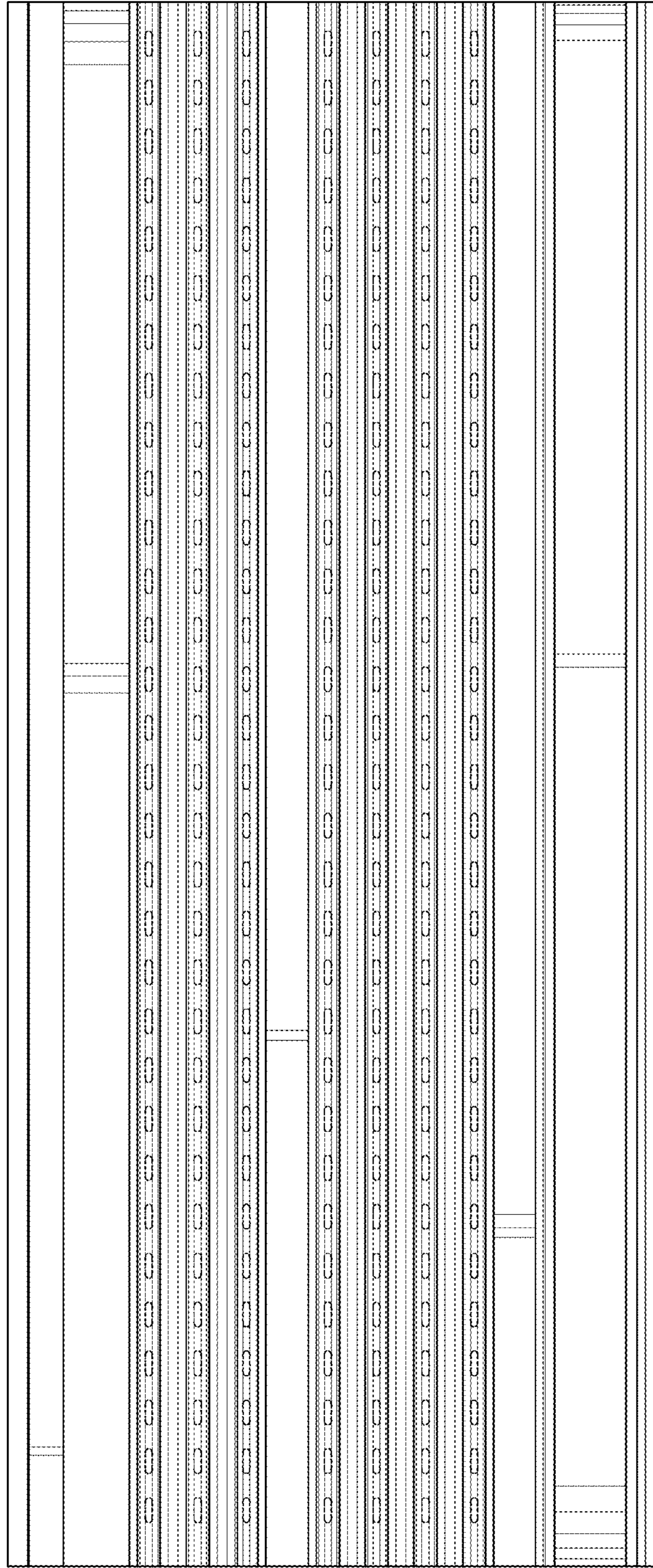

FIG. 4

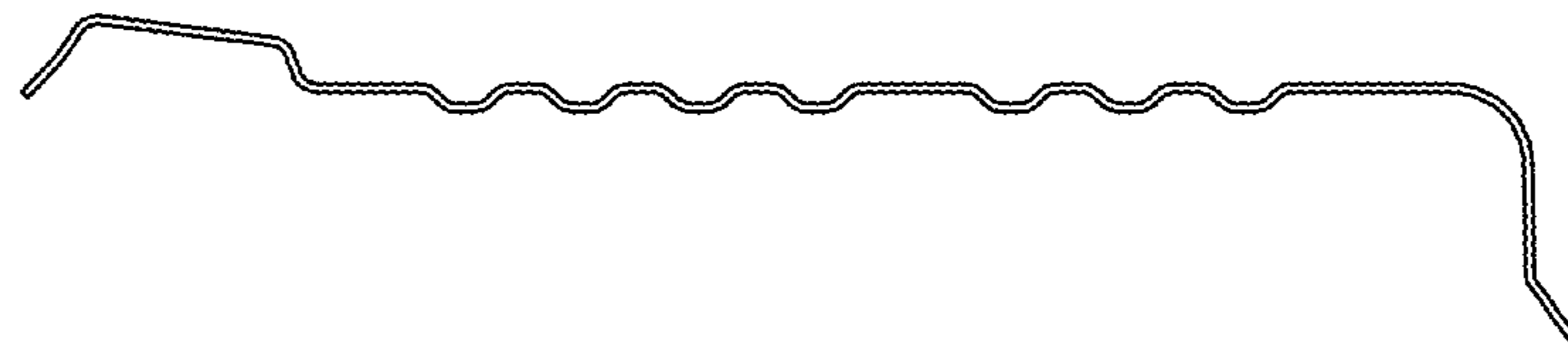

FIG. 5

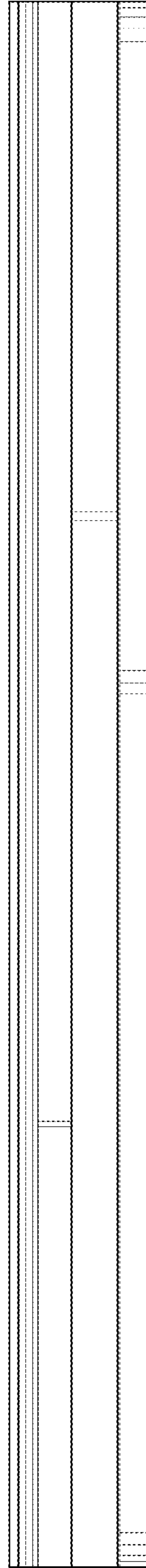

FIG. 6

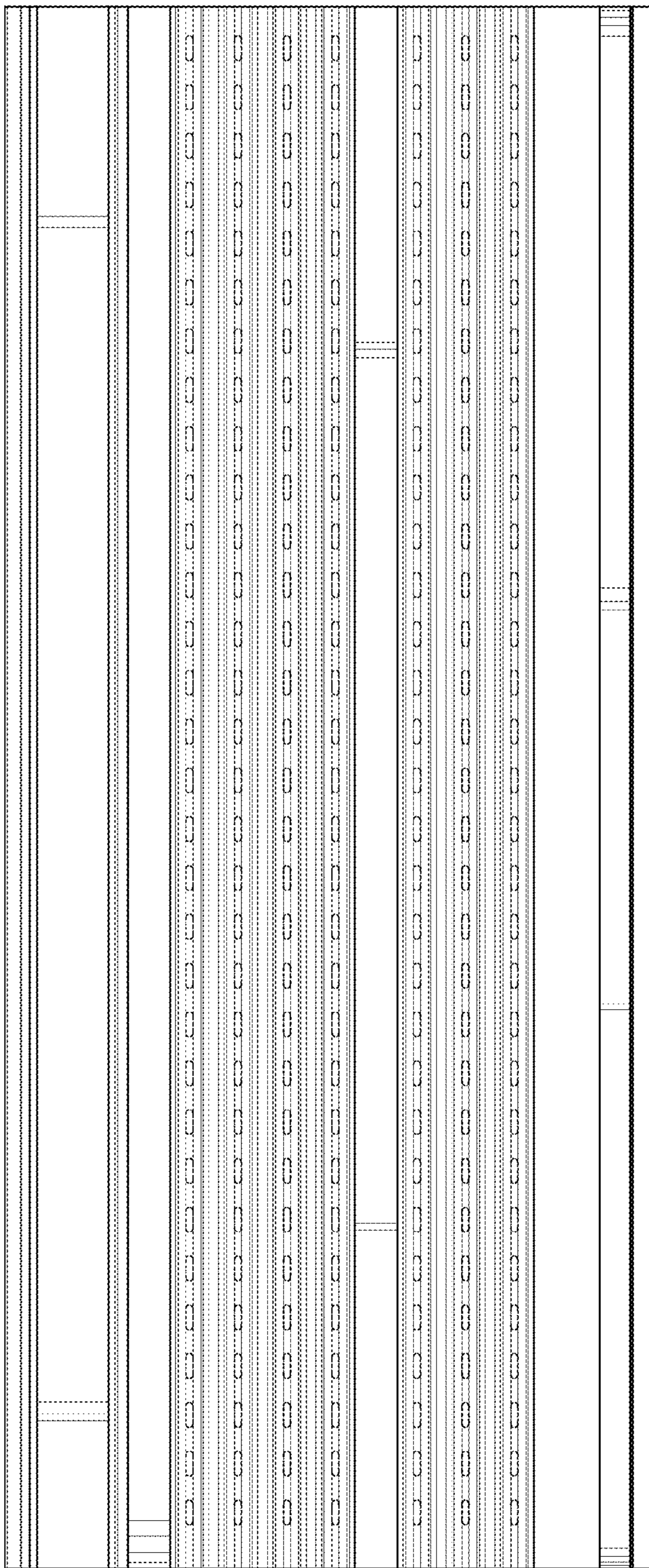
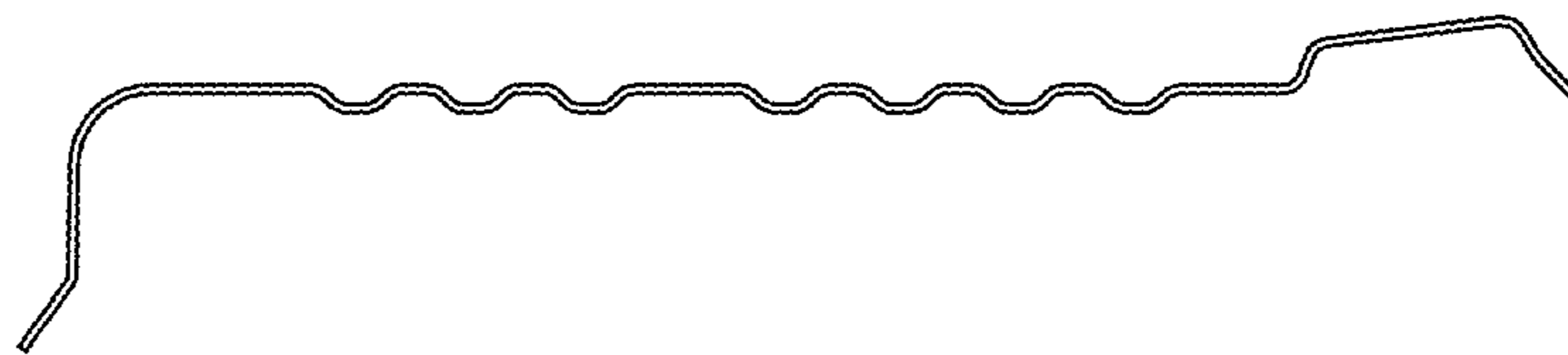

FIG. 7



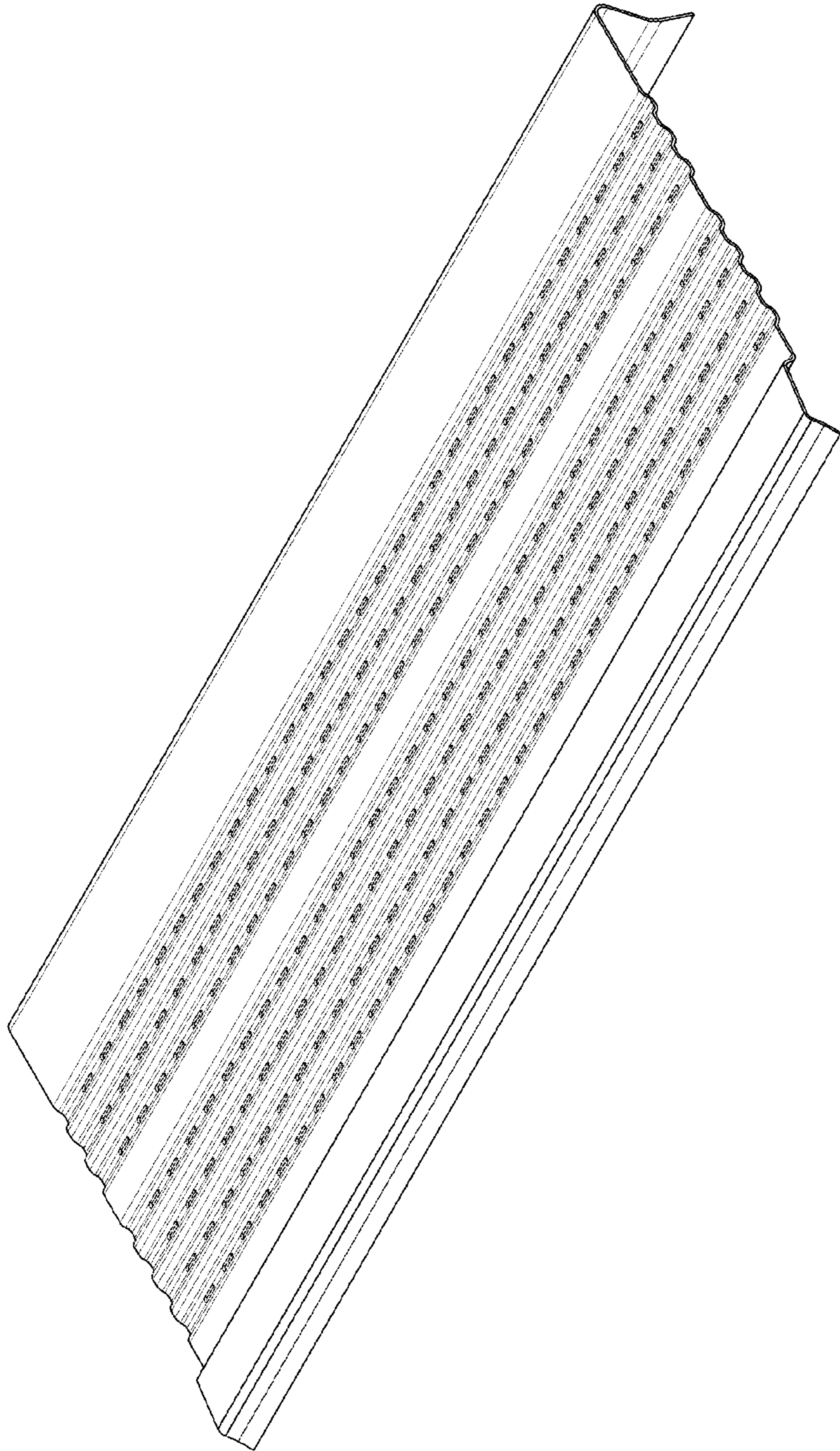

FIG. 8

FIG. 9

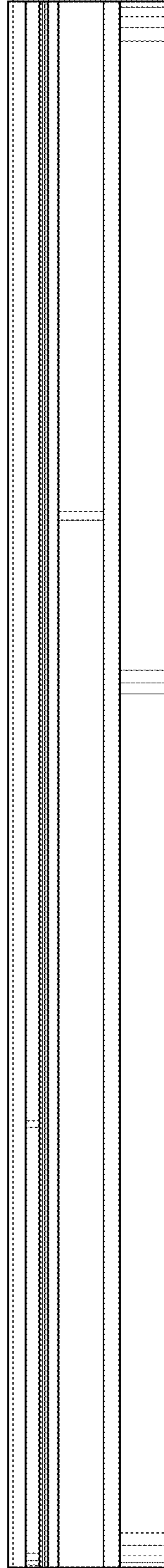

FIG. 10

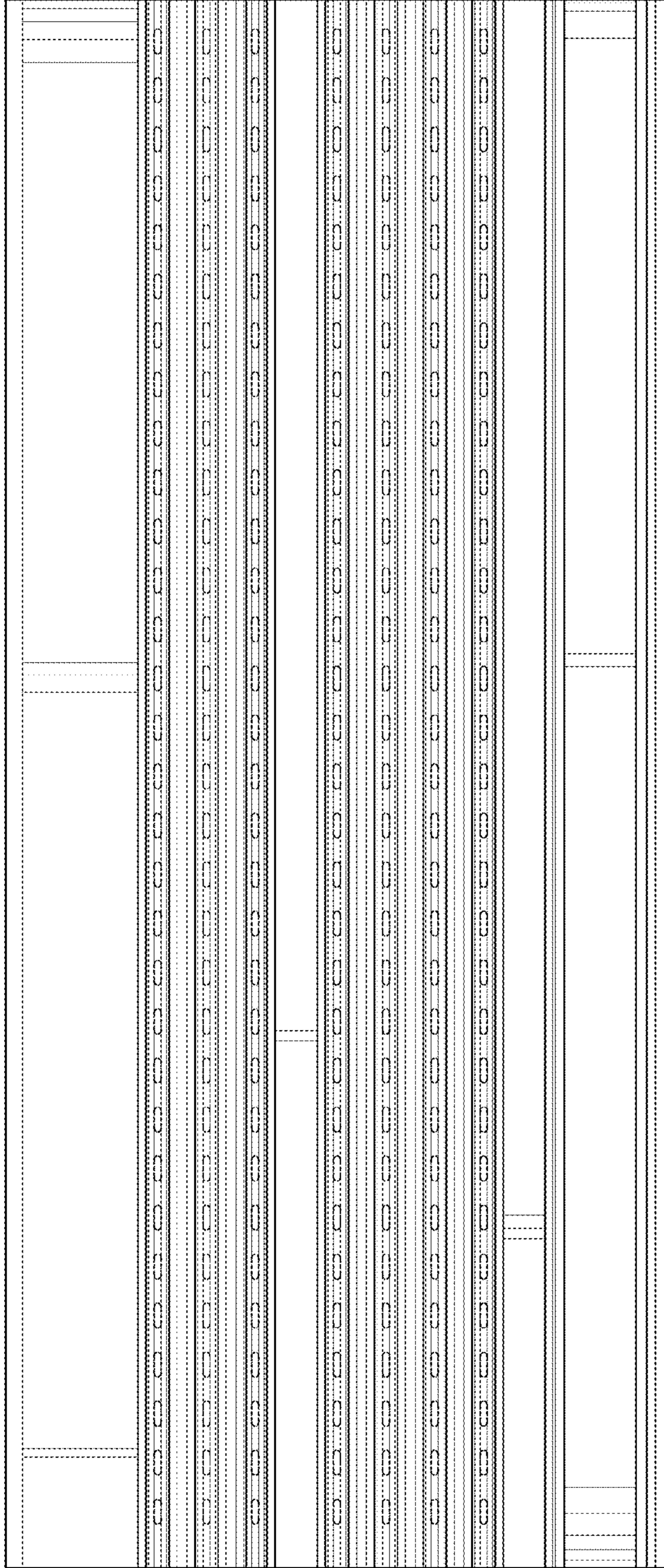

FIG. 11

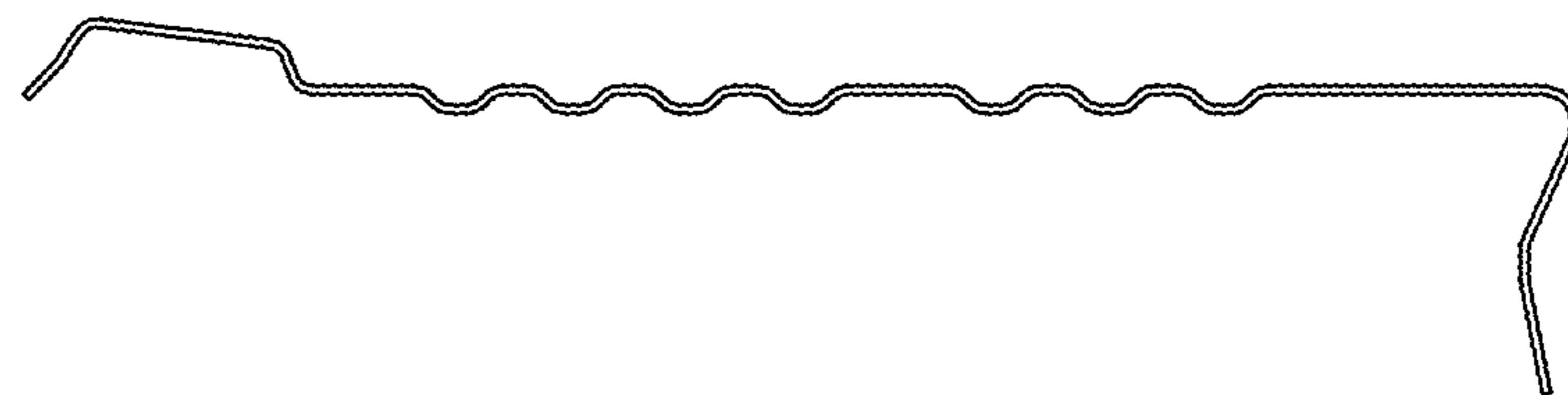

FIG. 12

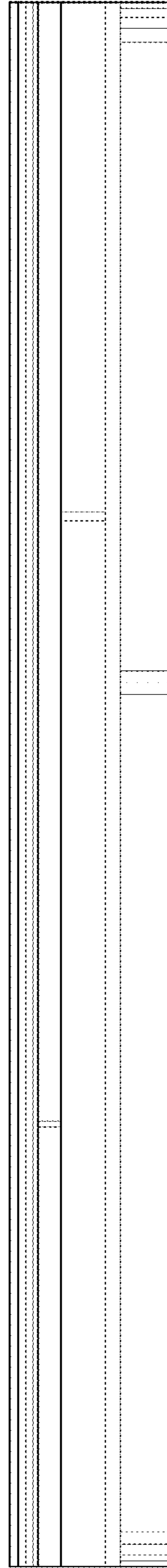

FIG. 13

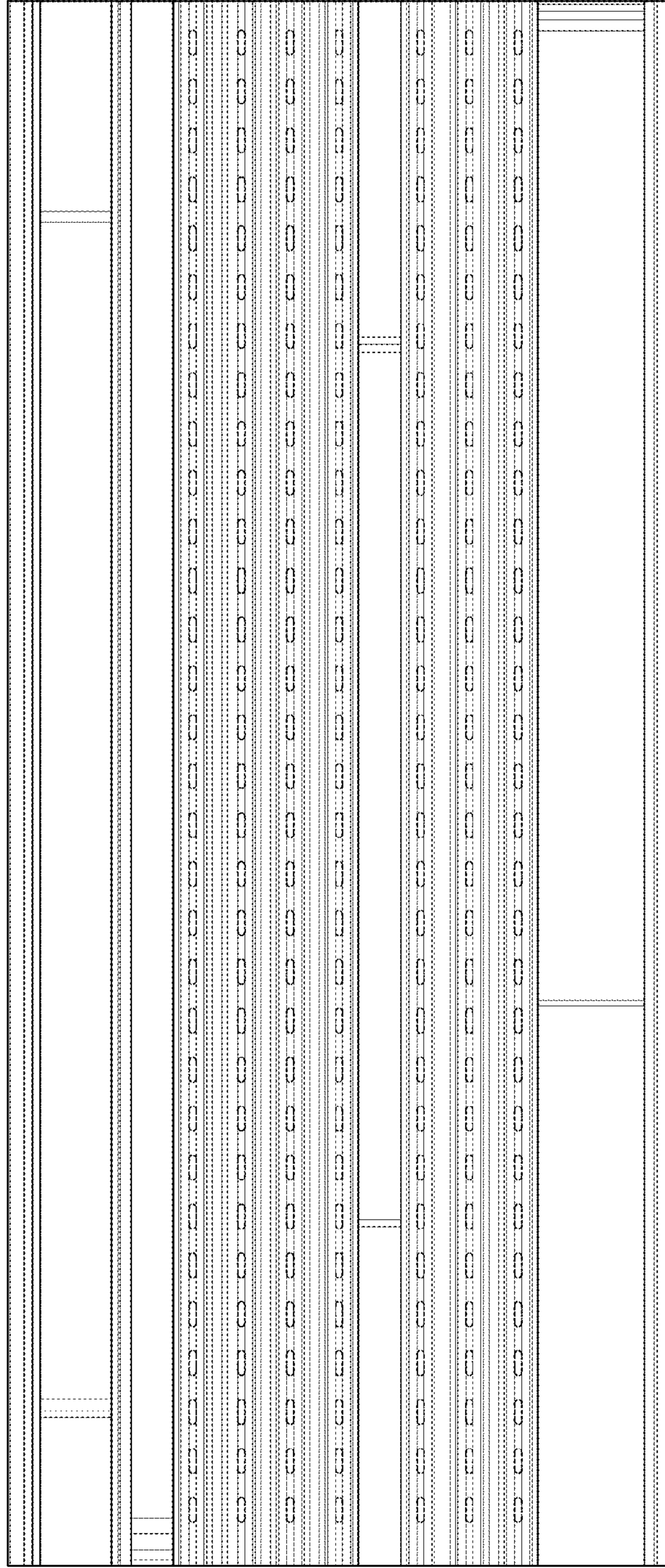
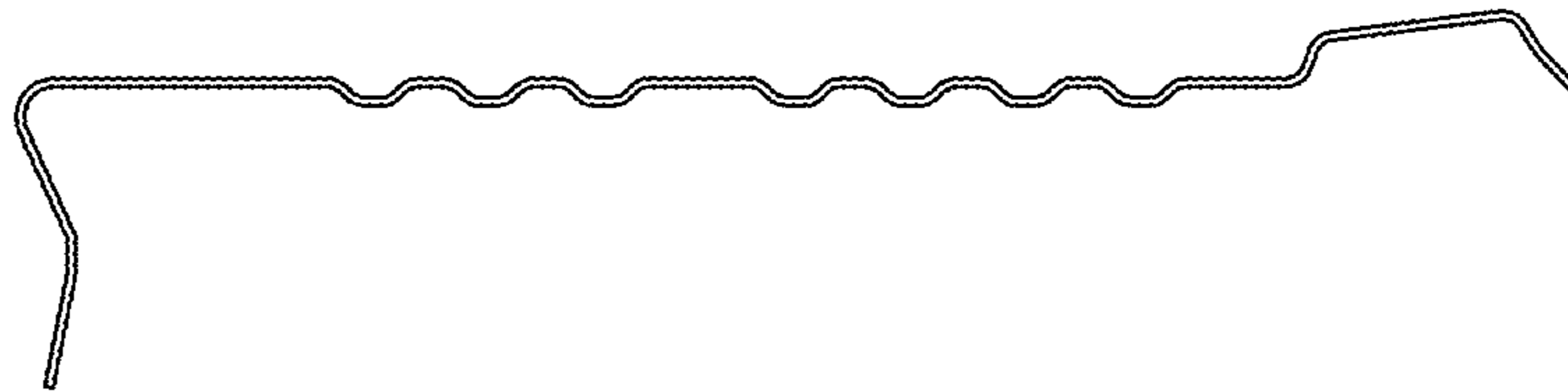

FIG. 14



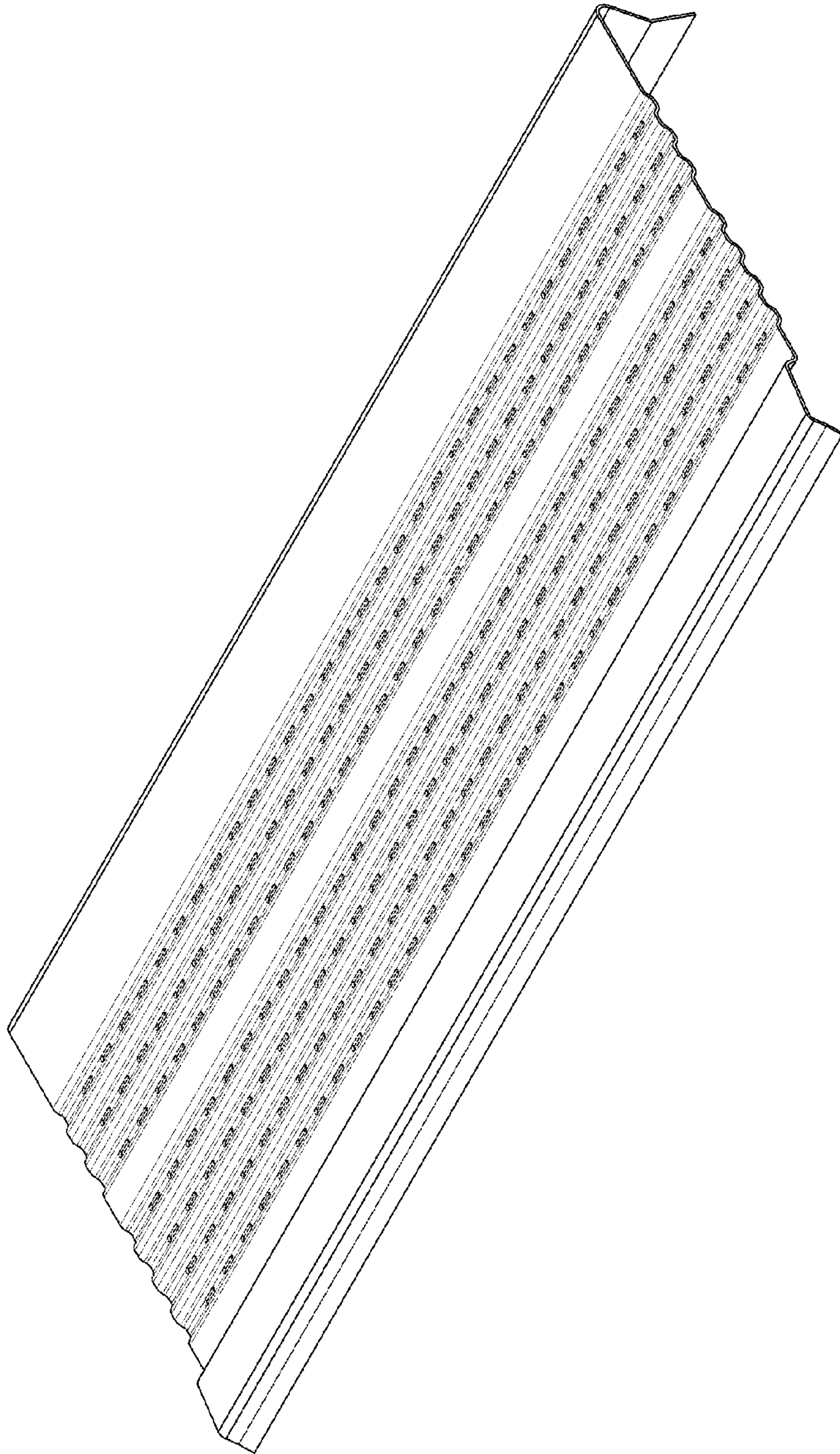

FIG. 15

FIG. 16

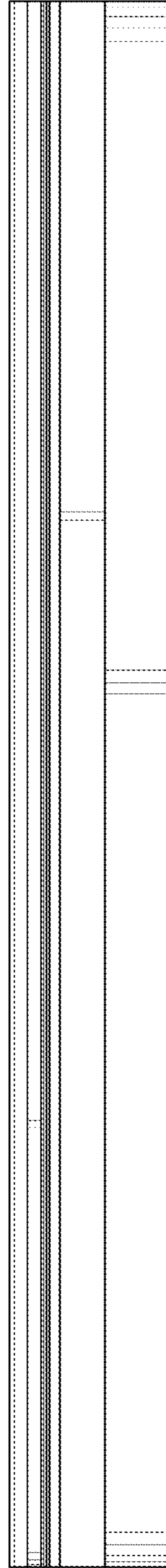

FIG. 17

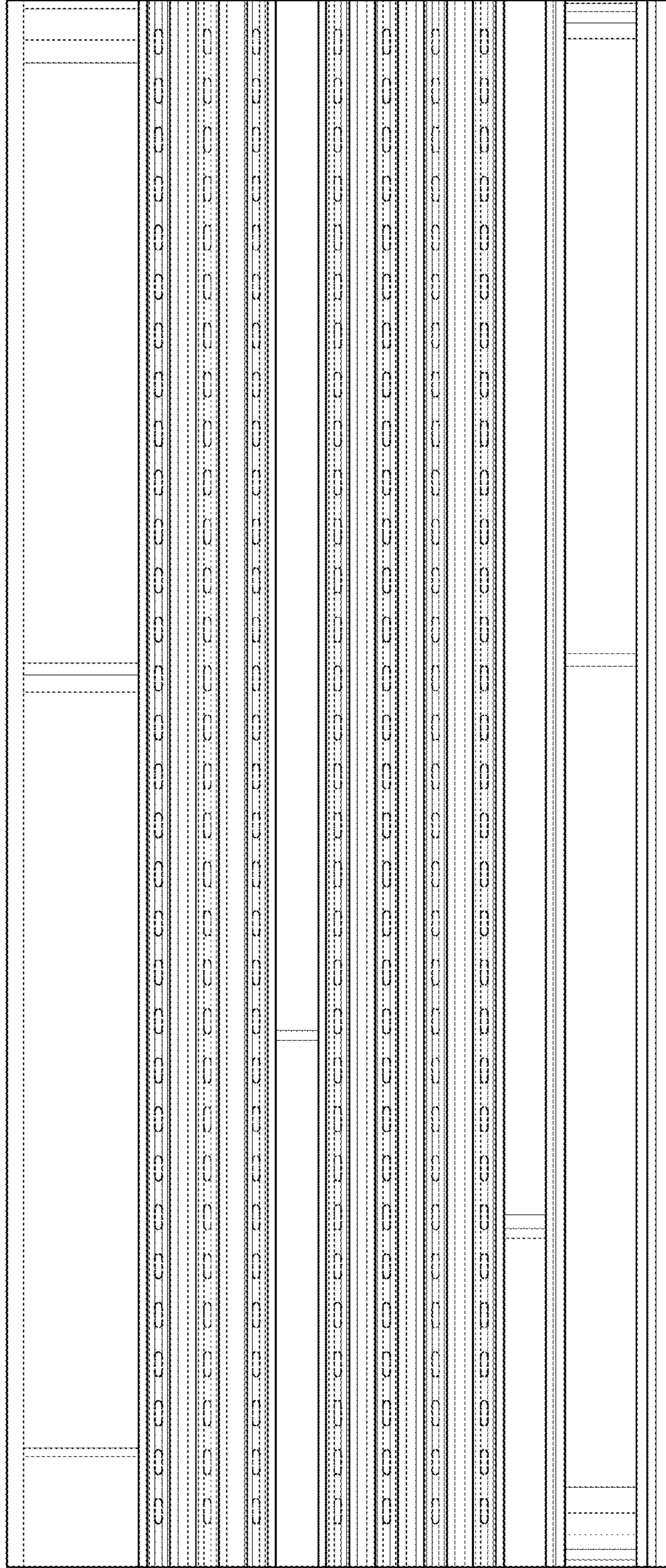

FIG. 18

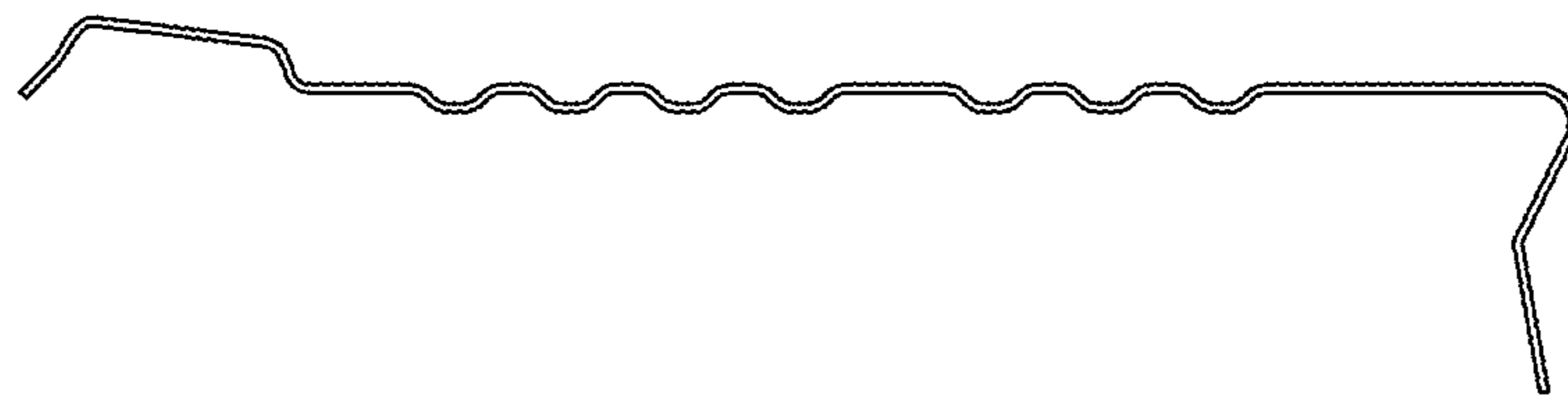

FIG. 19

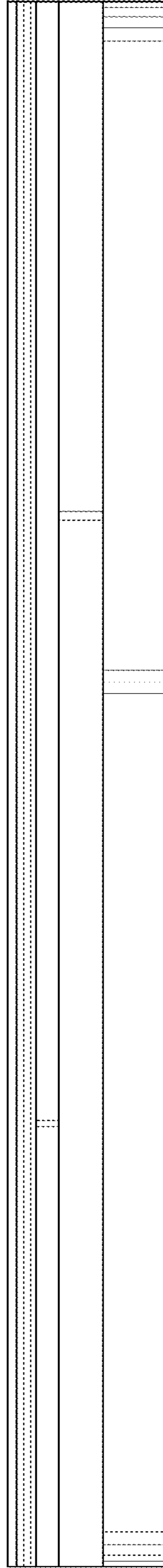

FIG. 20

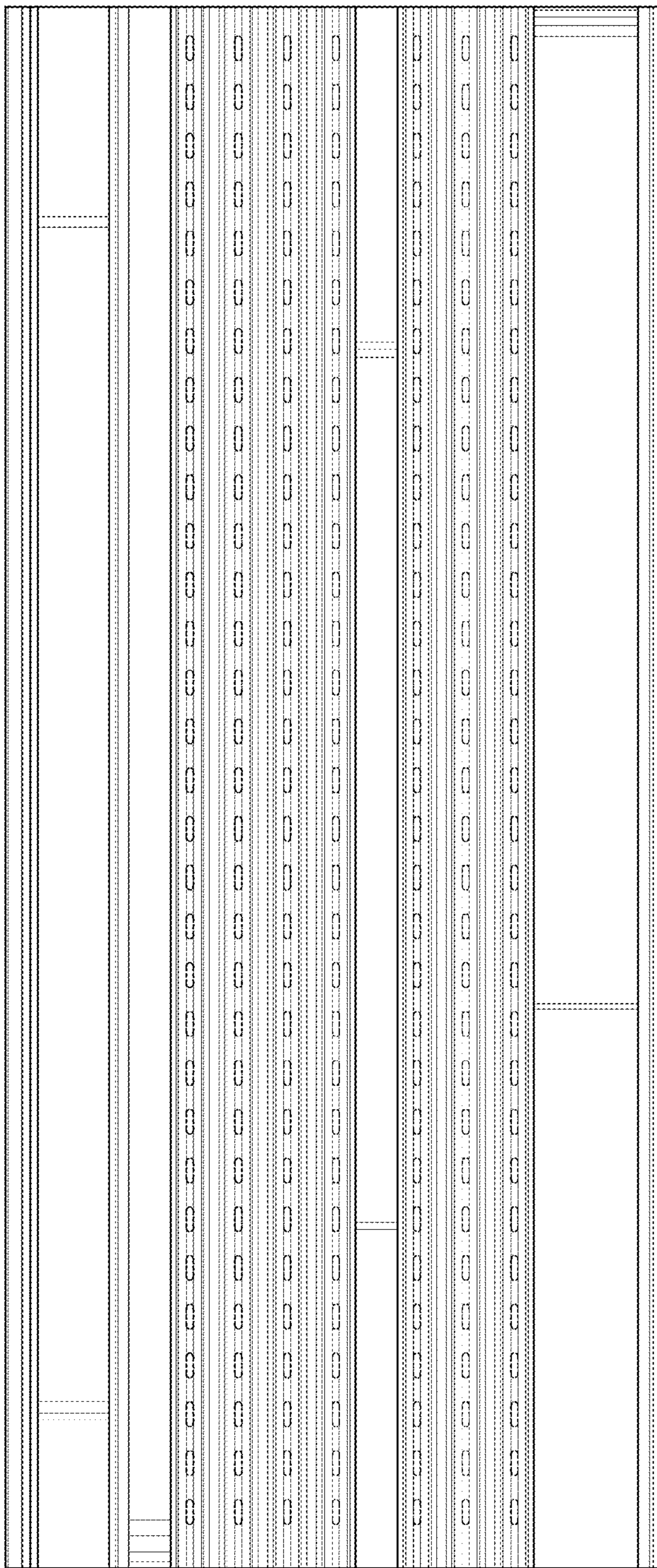
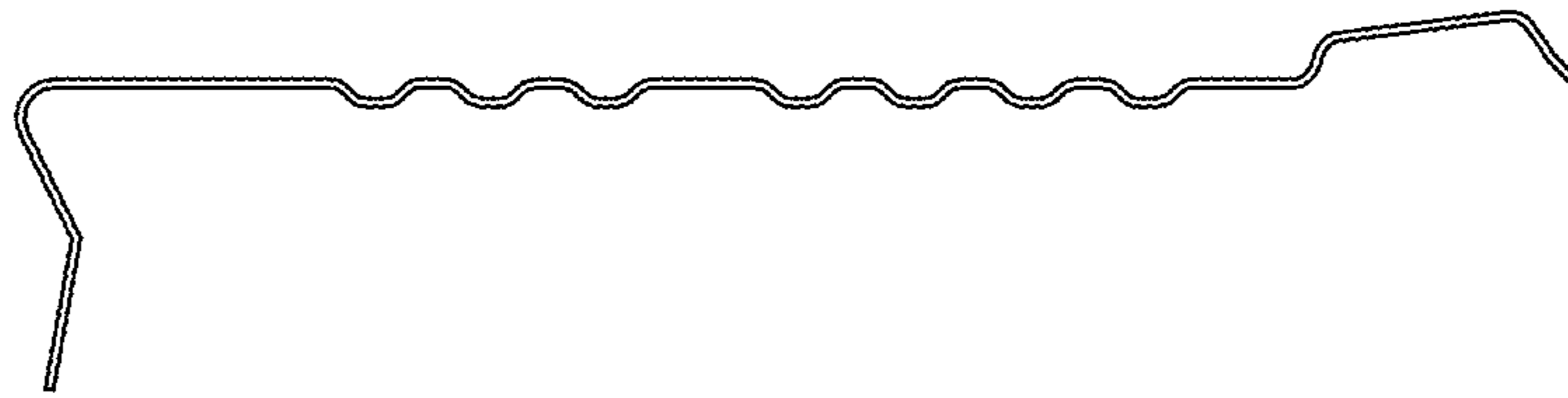

FIG. 21



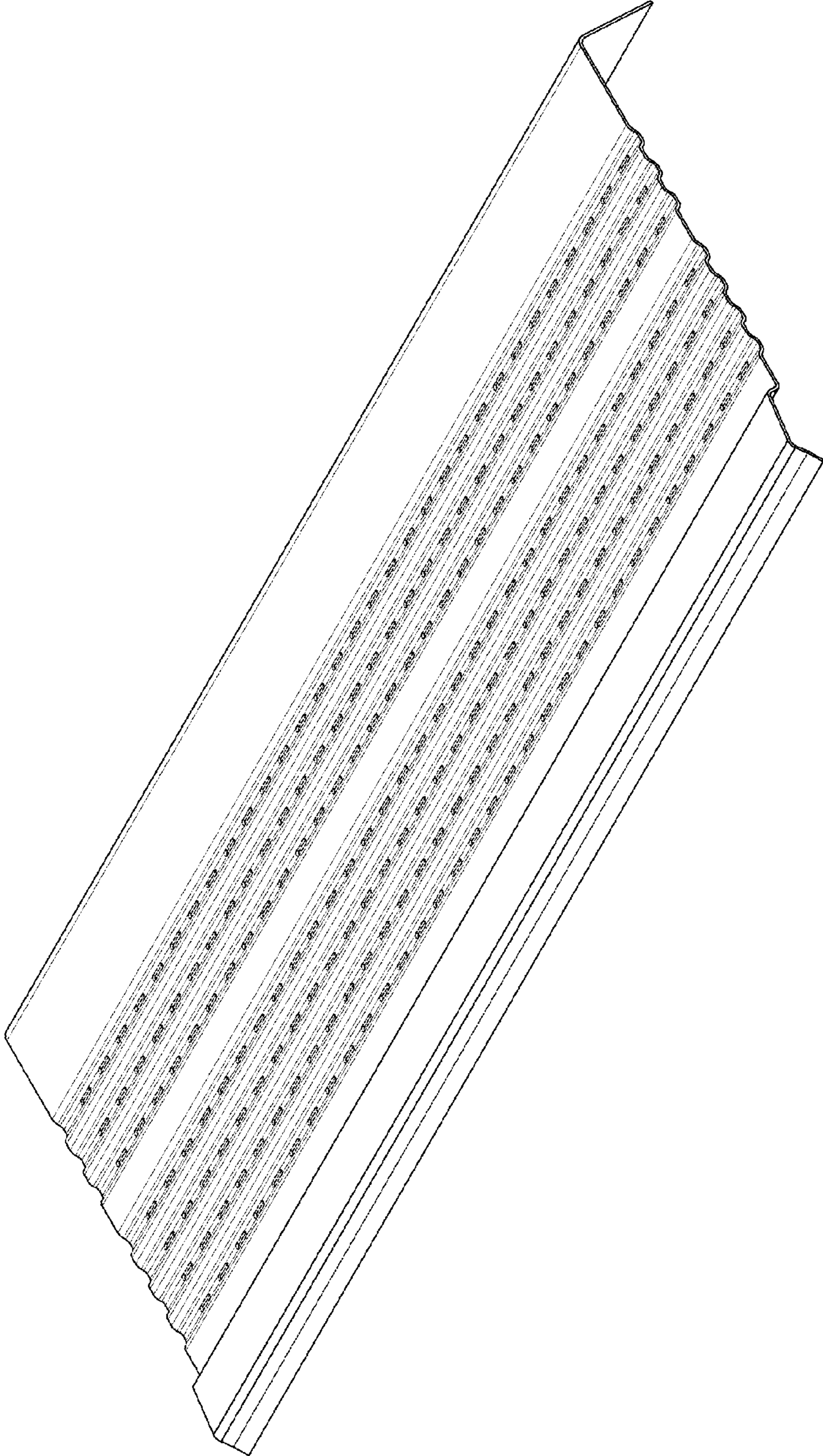

FIG. 22

FIG. 23

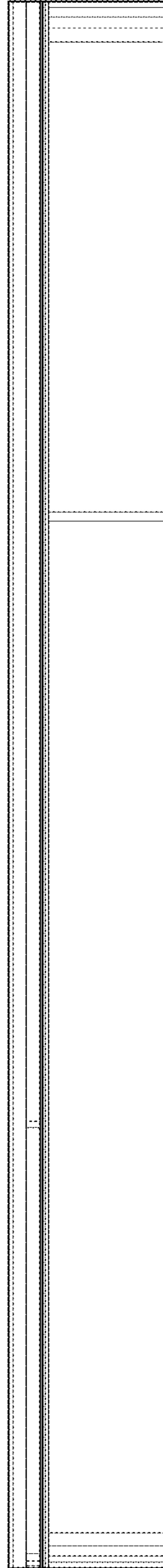

FIG. 24

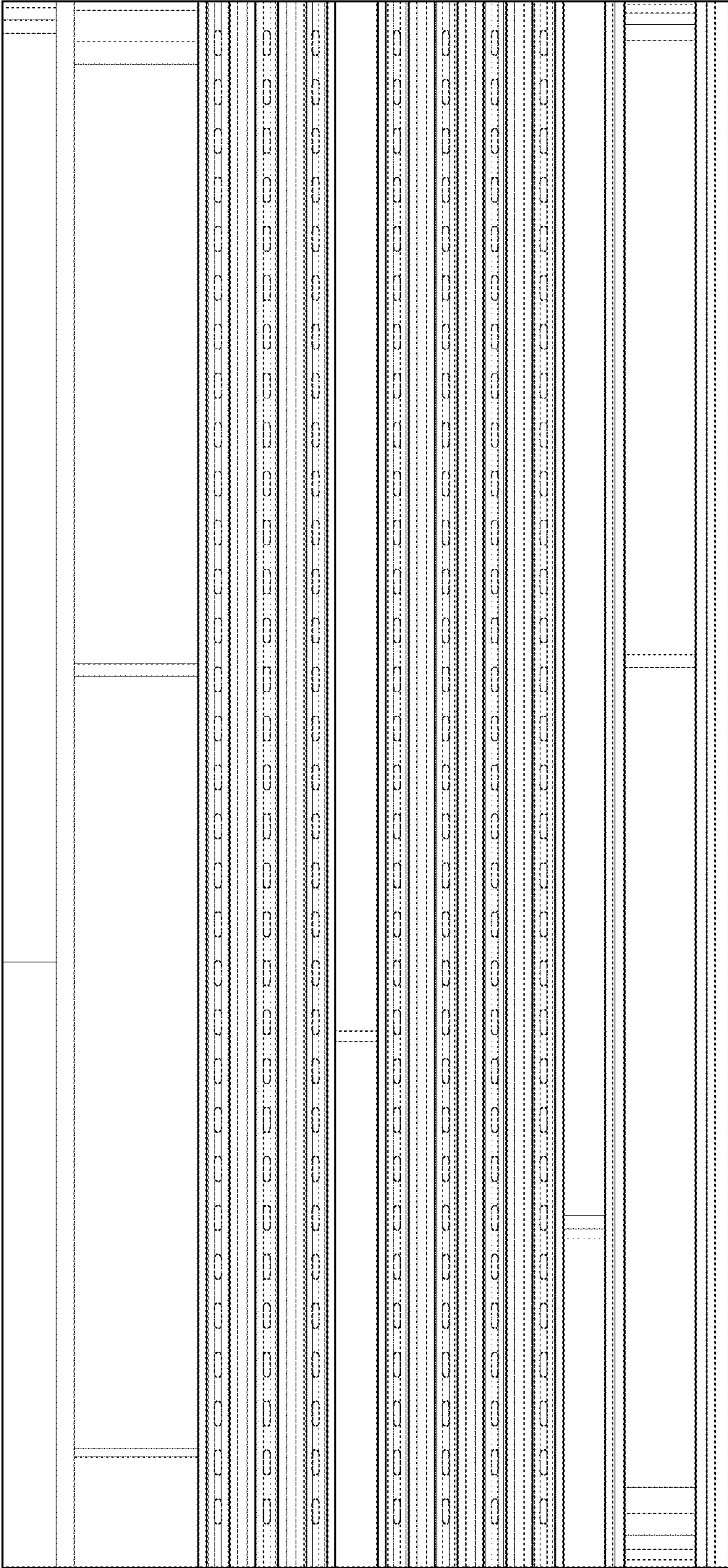

FIG. 25

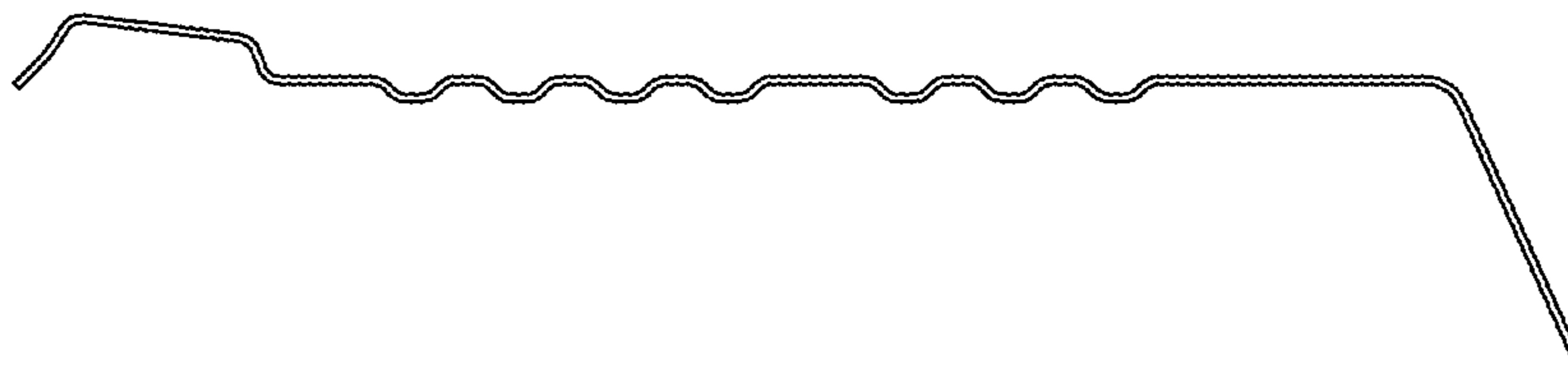

FIG. 26

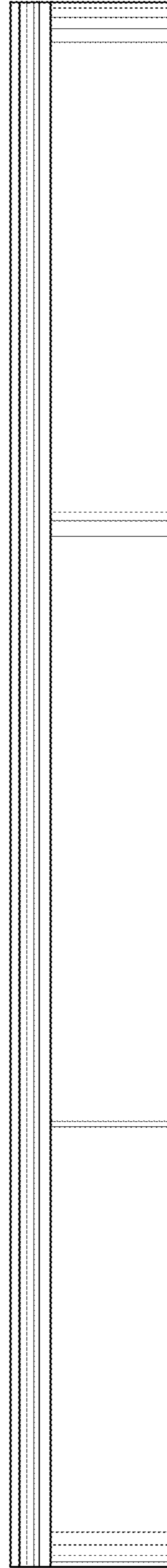

FIG. 27

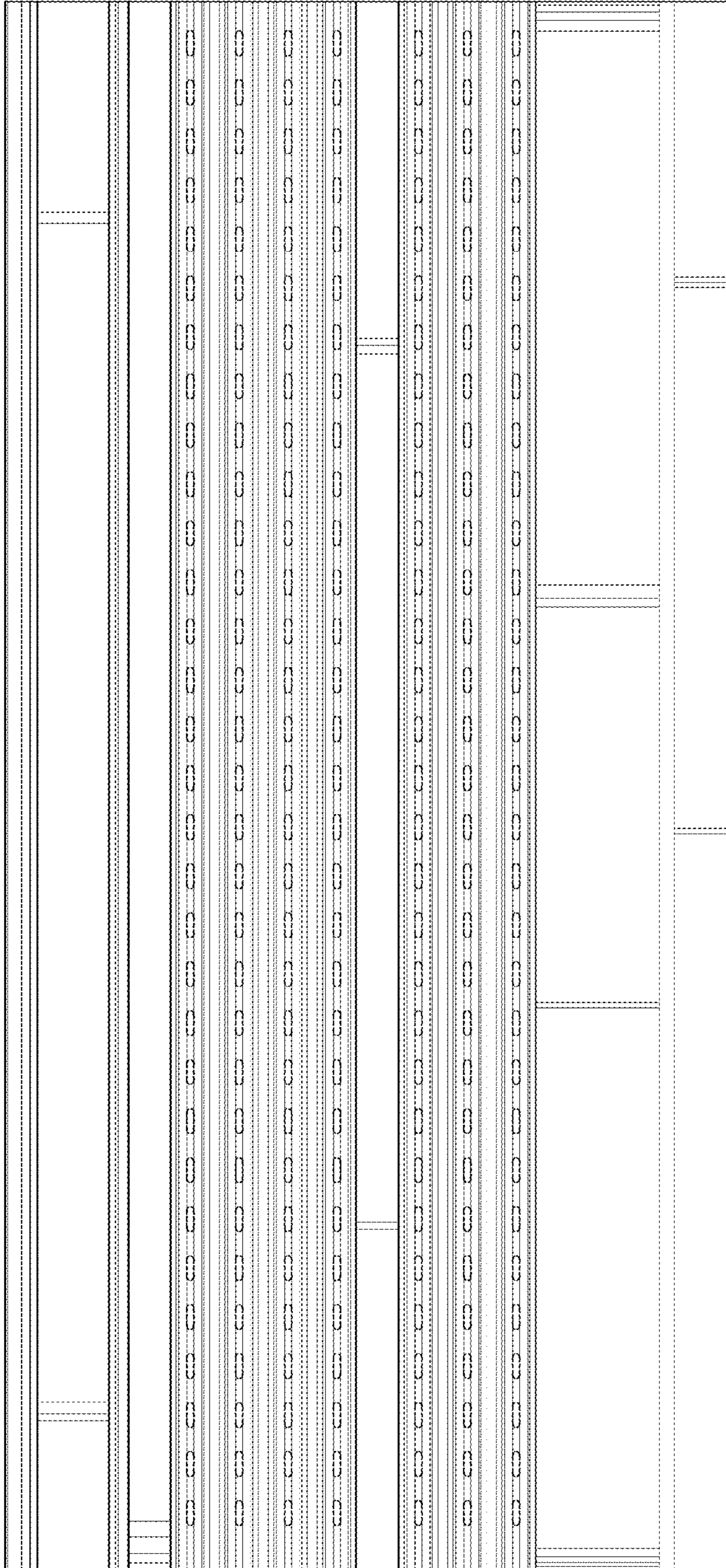

FIG. 28

