



US00D683811S

(12) **United States Design Patent**
Krammes

(10) **Patent No.:** **US D683,811 S**
(45) **Date of Patent:** **** Jun. 4, 2013**

(54) **WEED GUARD FOR A FISHING LURE BODY**

(71) Applicant: **Gary L. Krammes**, Pottsville, PA (US)

(72) Inventor: **Gary L. Krammes**, Pottsville, PA (US)

(**) Term: **14 Years**

(21) Appl. No.: **29/443,593**

(22) Filed: **Jan. 18, 2013**

6,772,553 B2 * 8/2004 Phillips et al. 43/42.39
D544,068 S * 6/2007 Becker D22/144
D585,957 S * 2/2009 White D22/144

* cited by examiner

Primary Examiner — Catheri Oliver-Garcia

(57) **CLAIM**

The ornamental design for a weed guard for a fishing lure body, as shown and described.

DESCRIPTION

FIG. 1 is a right side elevational view of the weed guard projecting upwardly from a rounded mounting portion on the fishing lure body to project above and to the sides of the barb of the hook member extending outwardly from the rounded tail of the body portion, the fishing lure body and hook member being shown in broken lines and not forming a part of this design;

FIG. 2 is a bottom plan view thereof;

FIG. 3 is a left side elevational view thereof;

FIG. 4 is a top plan view thereof;

FIG. 5 is a front elevational view thereof;

FIG. 6 is a rear elevational view thereof;

FIG. 7 is a front perspective view of the weed guard;

FIG. 8 is a front elevational view of an alternative embodiment of the weed guard with the central tine of the weed guard being shown in phantom and not forming a part of the invention; and,

FIG. 9 is a rear elevational view of the weed guard embodiment shown in FIG. 8.

Related U.S. Application Data

(62) Division of application No. 29/410,859, filed on Jan. 12, 2012, now Pat. No. Des. 675,285.

(51) **LOC (9) Cl.** **22-05**

(52) **U.S. Cl.**
USPC **D22/144**

(58) **Field of Classification Search**

USPC D22/144–145, 126–133; 43/42.37,
43/42.41, 42.35, 42.2, 42.4, 42.6, 42.25,
43/42.13, 42.19, 17.6, 42.34, 42.31, 43.2,
43/43.4, 43.6, 42.42, 42.39, 42.52

See application file for complete search history.

(56) **References Cited**

U.S. PATENT DOCUMENTS

D215,090 S * 9/1969 Bruckner D22/126
D272,080 S * 1/1984 Jablonski et al. D22/128
5,077,931 A * 1/1992 Marshall 43/42.52
D405,863 S * 2/1999 Laney D22/126
D439,629 S * 3/2001 Nelson D22/126

1 Claim, 5 Drawing Sheets

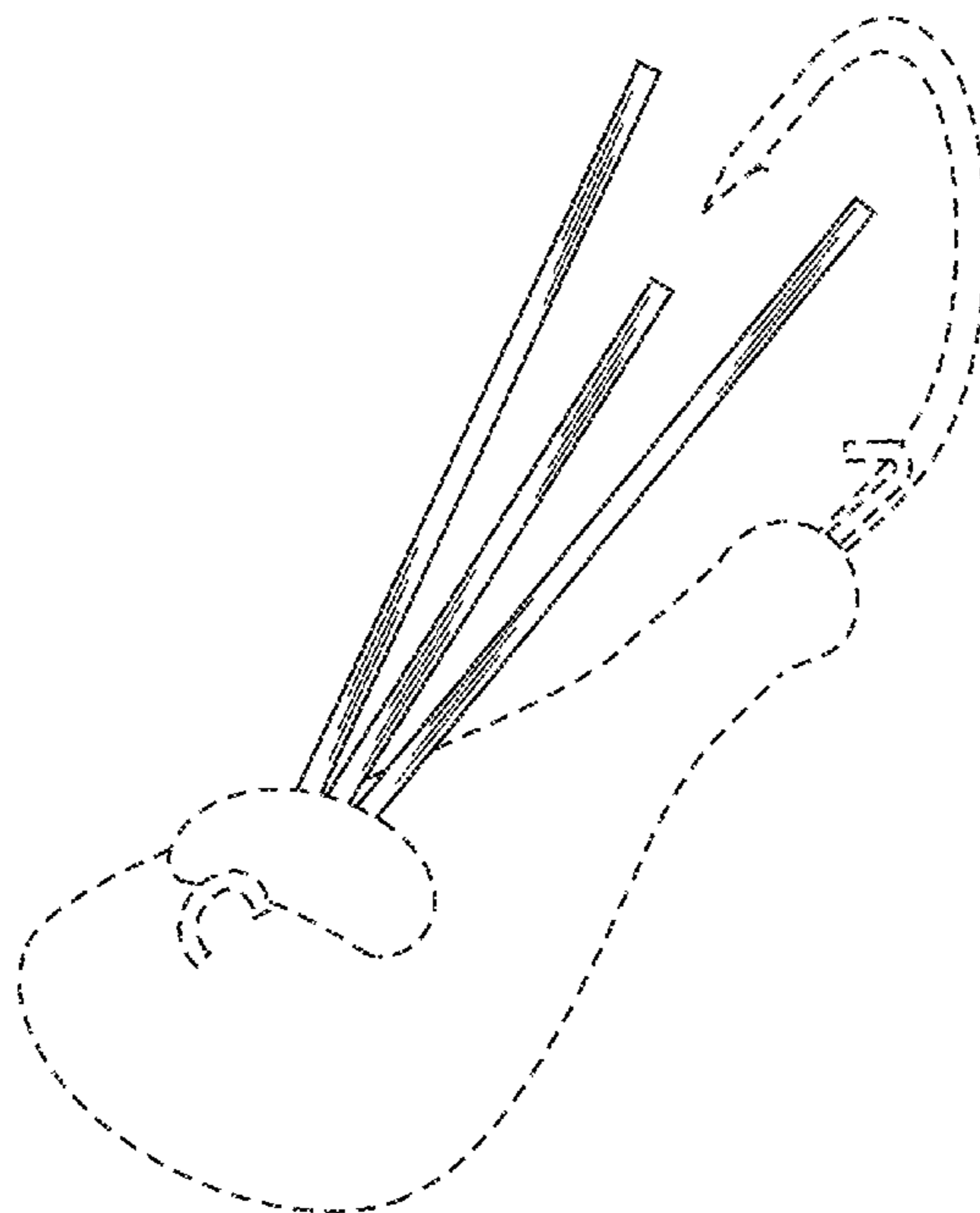

Fig. 1

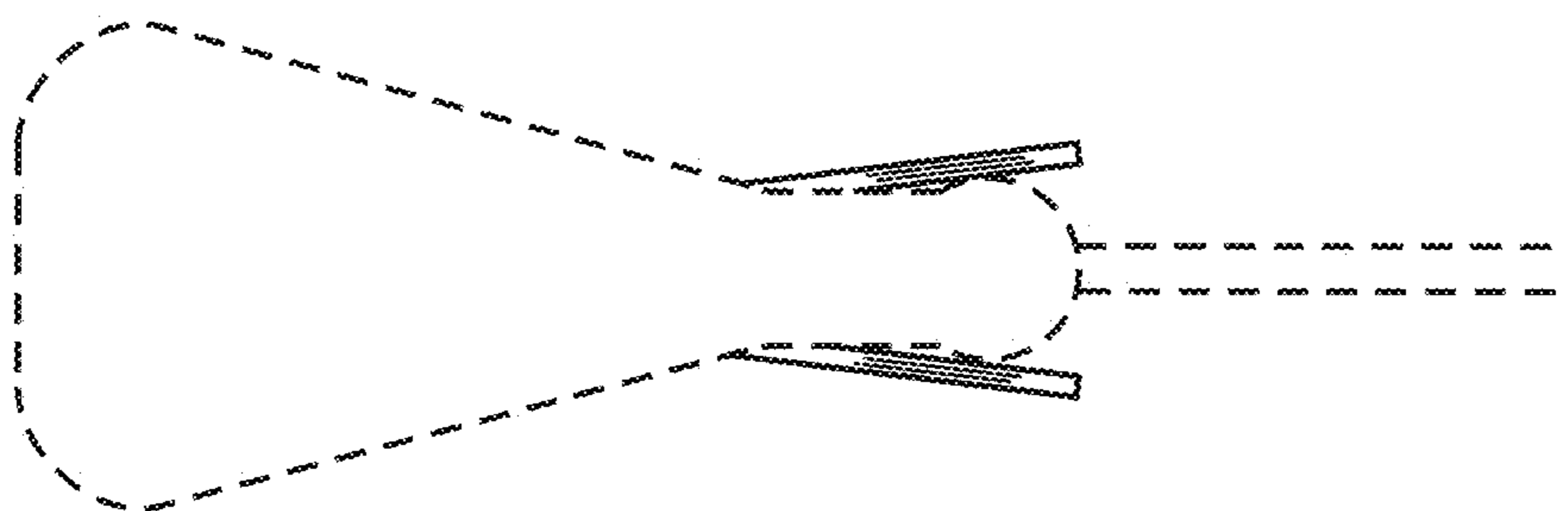
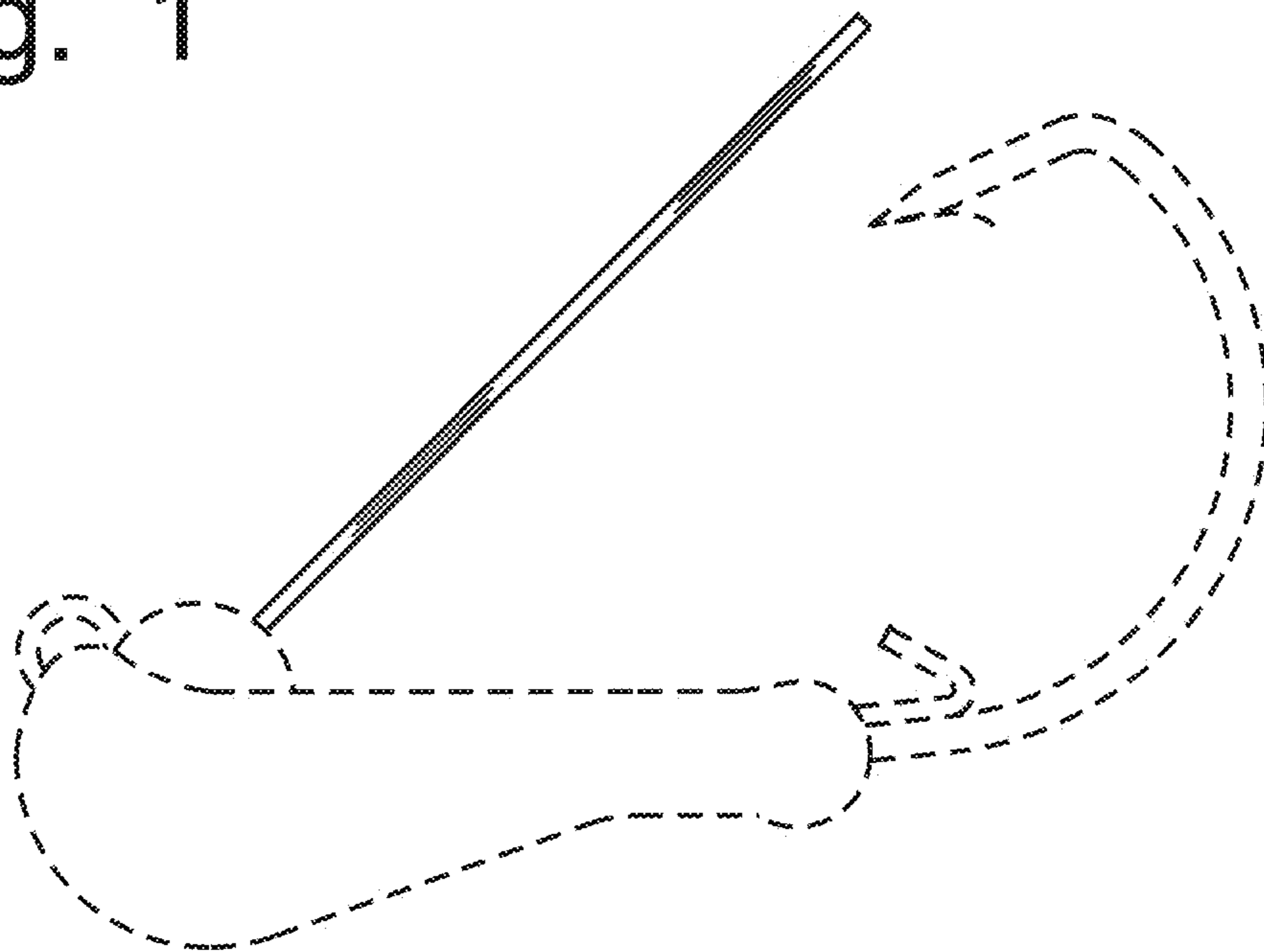

Fig. 2

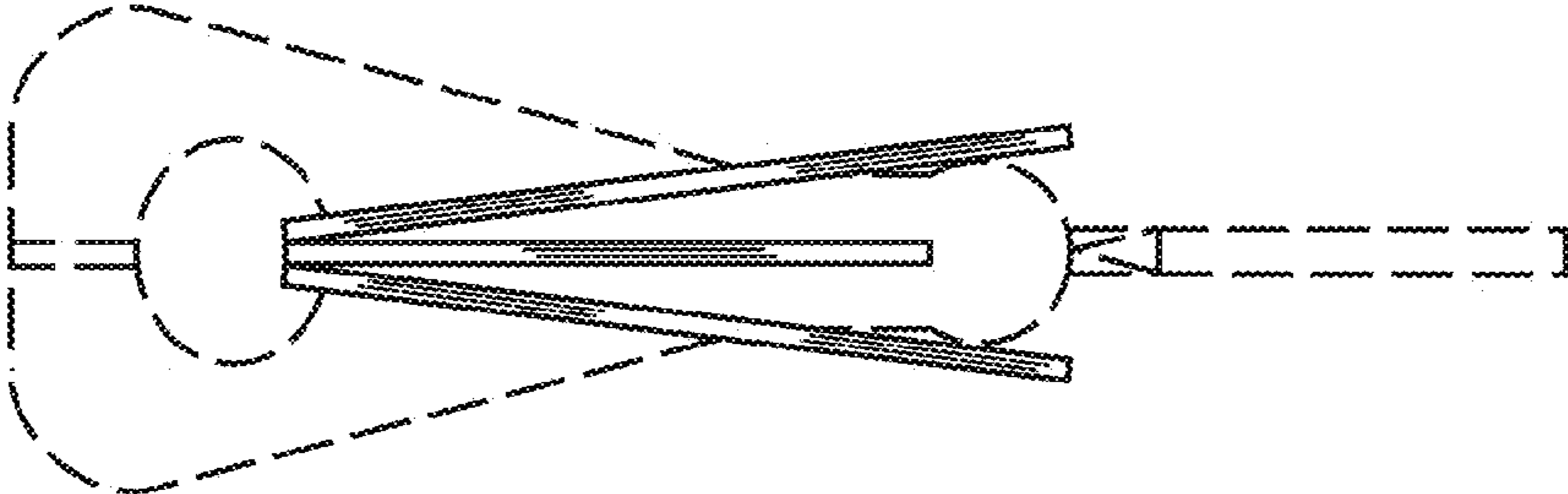
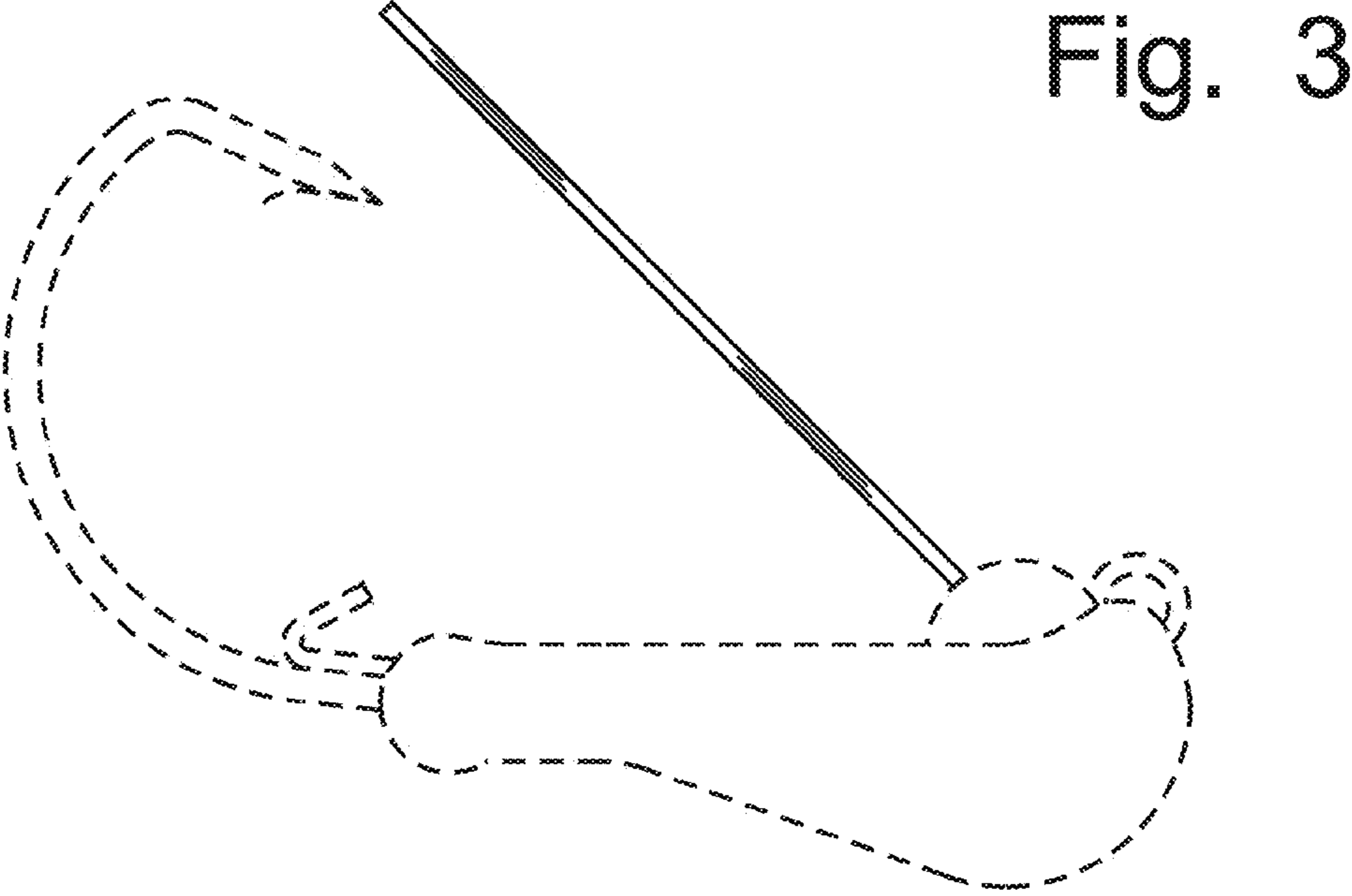

Fig. 4

Fig. 5

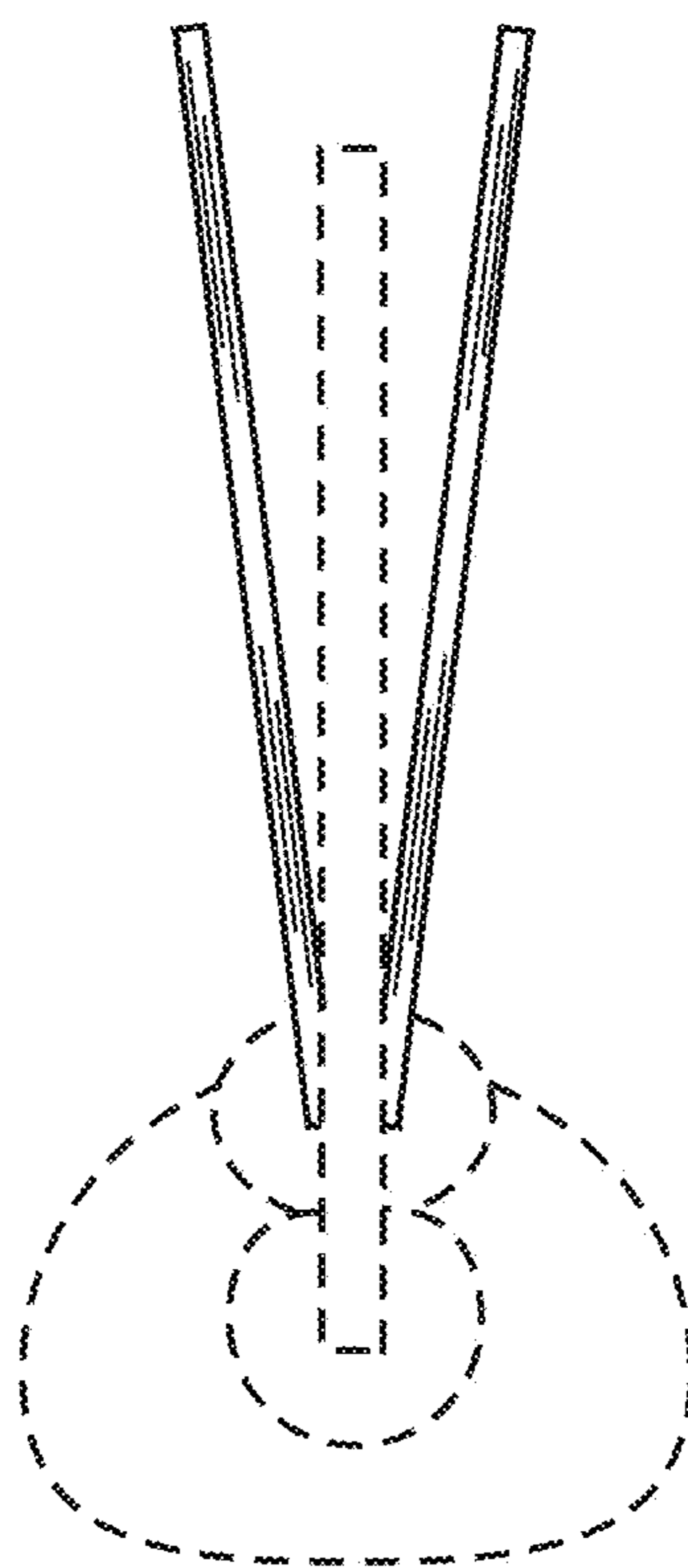
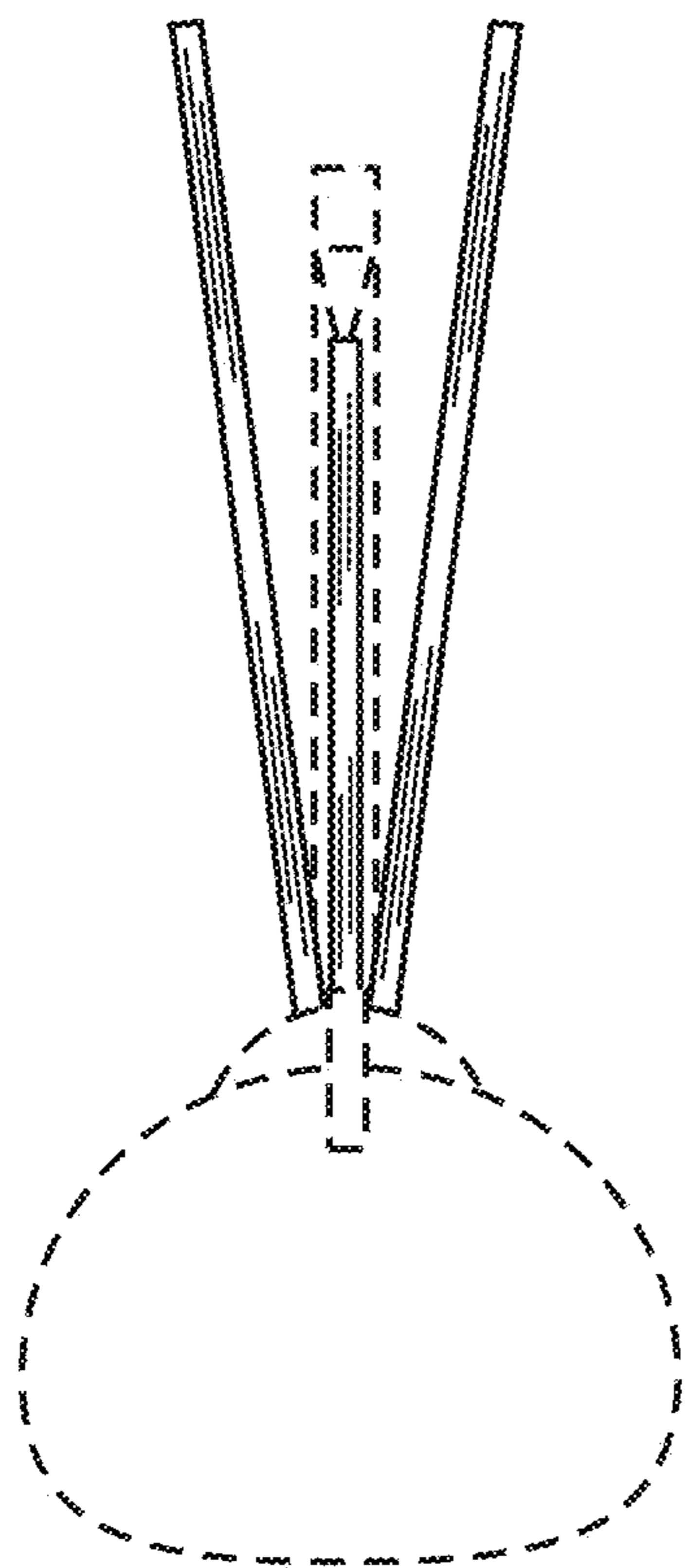

Fig. 6

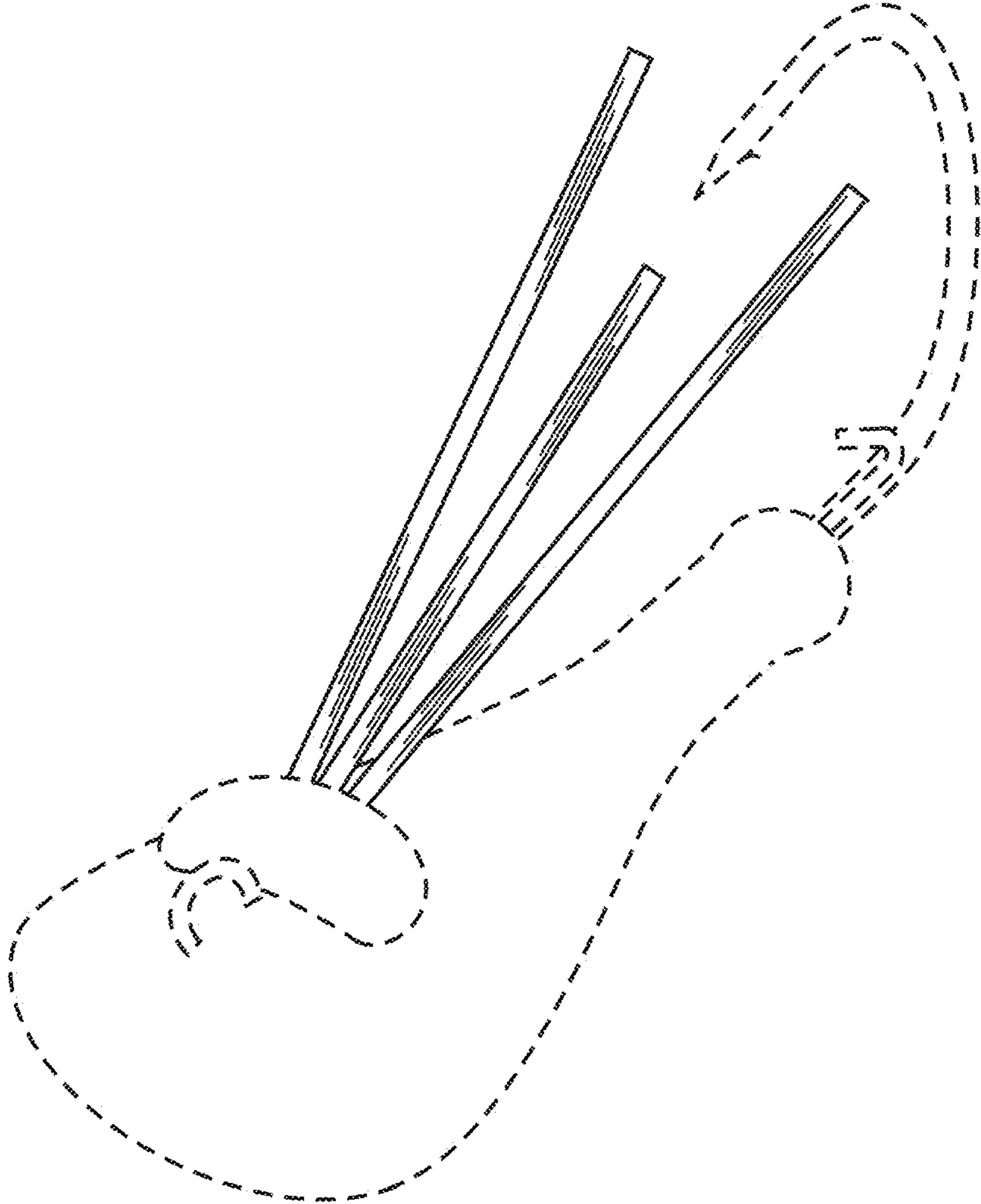

Fig. 7

Fig. 8

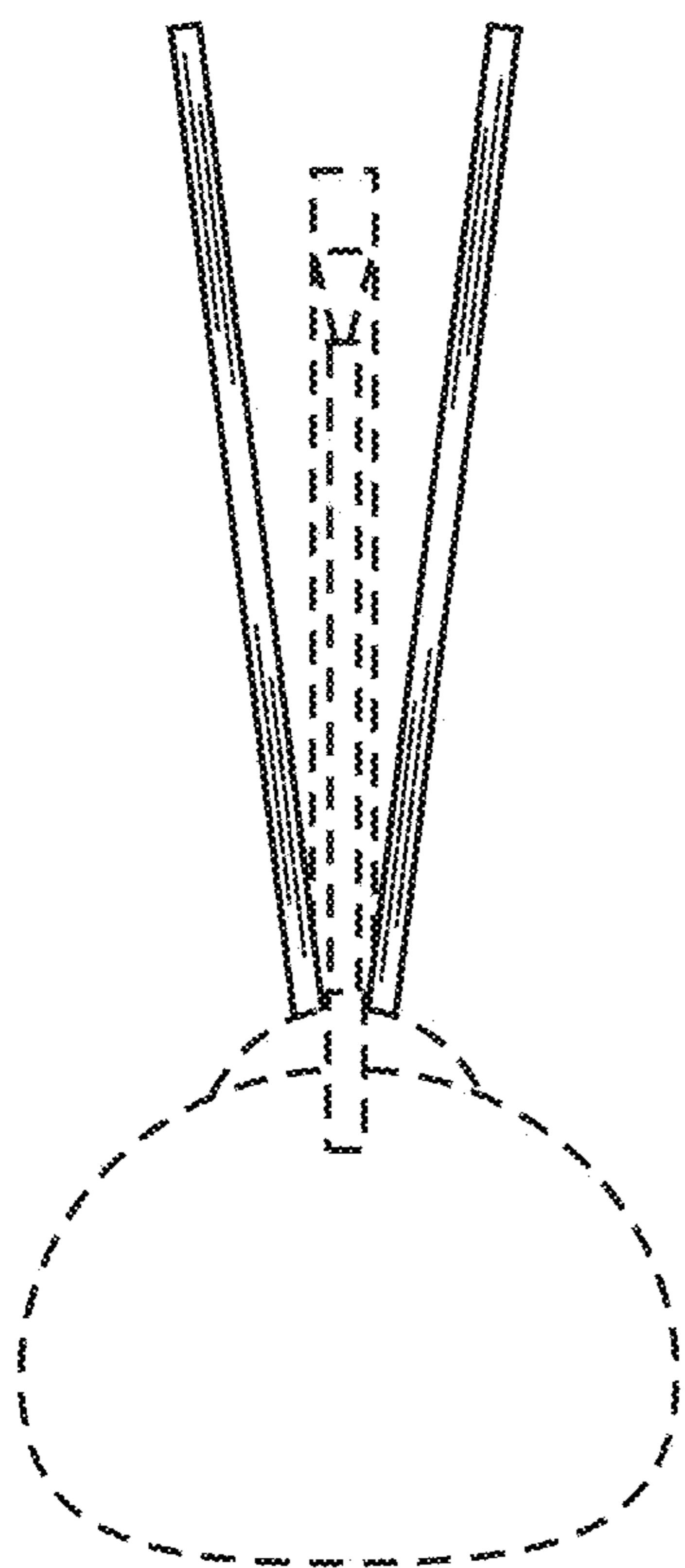

Fig. 9

