



US00D683807S

(12) **United States Design Patent**
Elkaim

(10) **Patent No.:** **US D683,807 S**

(45) **Date of Patent:** **** Jun. 4, 2013**

(54) **GUN SLING PLATE**

(75) **Inventor:** **Phillippe Elkaim**, Scottsdale, AZ (US)

(73) **Assignee:** **Central Pacific Industries (USA) Inc.**,
Scottsdale, AZ (US)

(**) **Term:** **14 Years**

(21) **Appl. No.:** **29/411,869**

(22) **Filed:** **Jan. 27, 2012**

(51) **LOC (9) Cl.** **22-01**

(52) **U.S. Cl.**
USPC **D22/108**

(58) **Field of Classification Search**
USPC D22/108; 42/85, 94; D29/101.1-101.2;
224/150; D3/214-215, 262

See application file for complete search history.

(56) **References Cited**

U.S. PATENT DOCUMENTS

5,303,859	A *	4/1994	Jenkin	224/149
6,263,892	B1 *	7/2001	Baker	135/66
6,536,153	B2 *	3/2003	Lindsey	42/85
6,598,330	B2 *	7/2003	Garrett et al.	42/85
D495,870	S *	9/2004	Verdugo	D3/215
D508,726	S *	8/2005	Storch	D22/108
D525,336	S *	7/2006	Esch	D22/108
7,082,709	B2 *	8/2006	Lindsey	42/85

D568,957	S *	5/2008	Esch	D22/108
D612,895	S *	3/2010	Stein	D21/573
7,841,496	B1 *	11/2010	Schweikert	224/150
D645,930	S *	9/2011	Pearce	D22/108
2002/0020724	A1 *	2/2002	Lindsey	224/150
2007/0257072	A1 *	11/2007	Pena et al.	224/150
2008/0217371	A1 *	9/2008	Wemmer	224/579
2011/0186603	A1 *	8/2011	Alford	224/150
2012/0255976	A1 *	10/2012	Dees	224/150

* cited by examiner

Primary Examiner — Michael A Pratt

(74) *Attorney, Agent, or Firm* — Woods Oviatt Gilman LLP

(57) **CLAIM**

The ornamental design for a gun sling plate, as shown and described.

DESCRIPTION

FIG. 1 is an isometric view of a gun sling plate showing my new design;

FIG. 2 is a top view thereof;

FIG. 3 is a right side view thereof;

FIG. 4 is a front view thereof;

FIG. 5 is a back view thereof;

FIG. 6 is a bottom view thereof; and,

FIG. 7 is a left side view thereof.

1 Claim, 2 Drawing Sheets

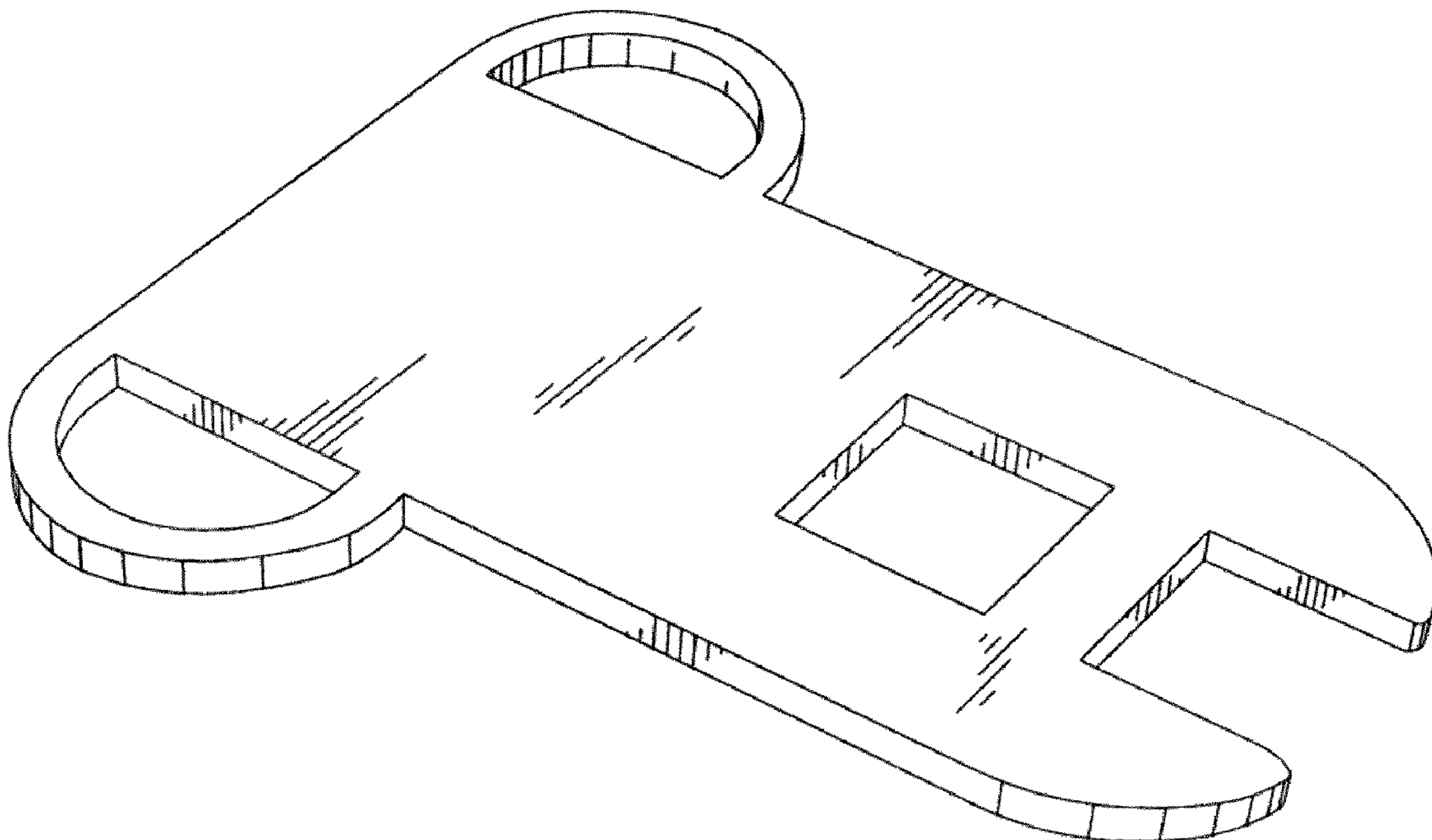

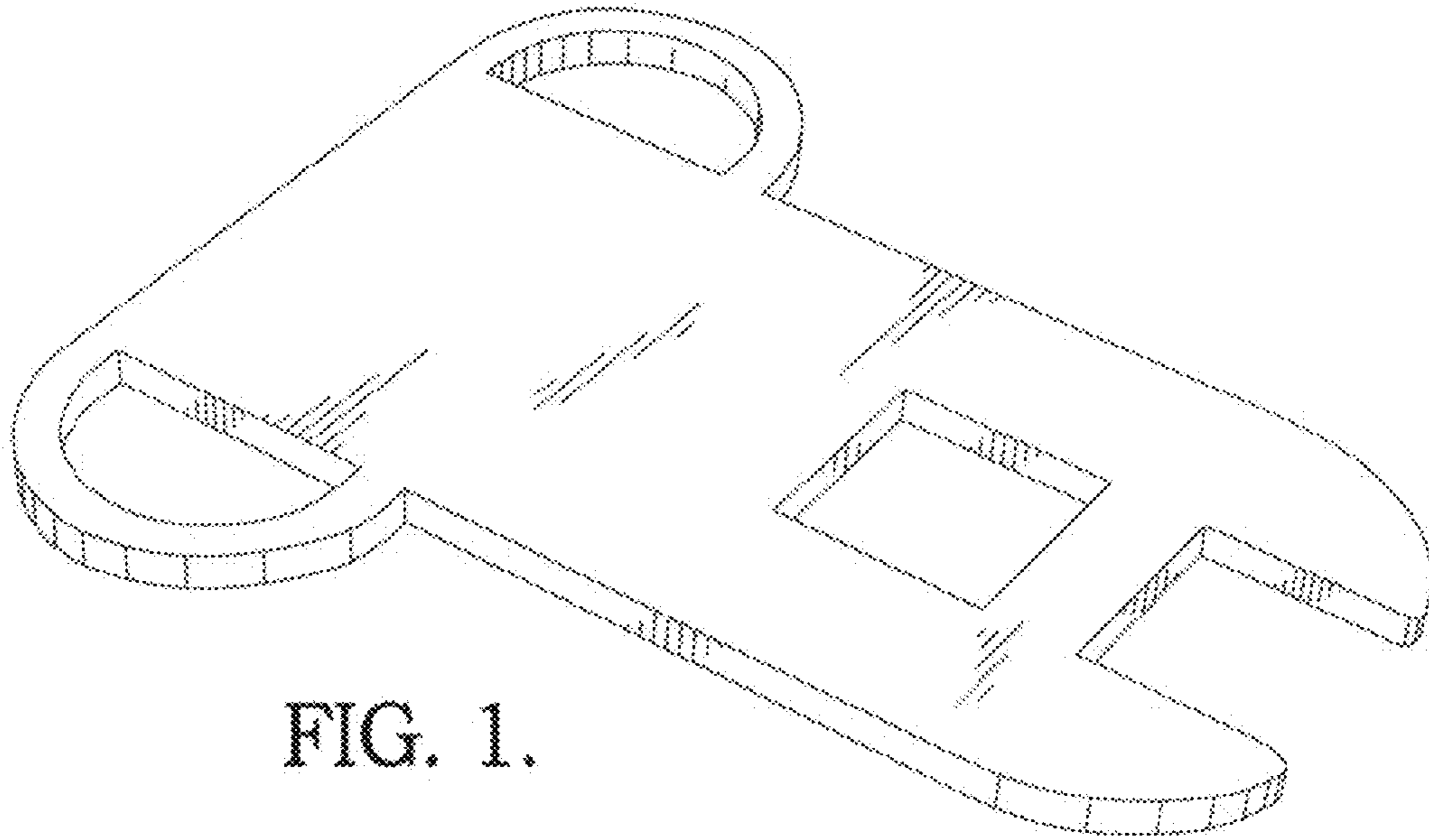

FIG. 1.

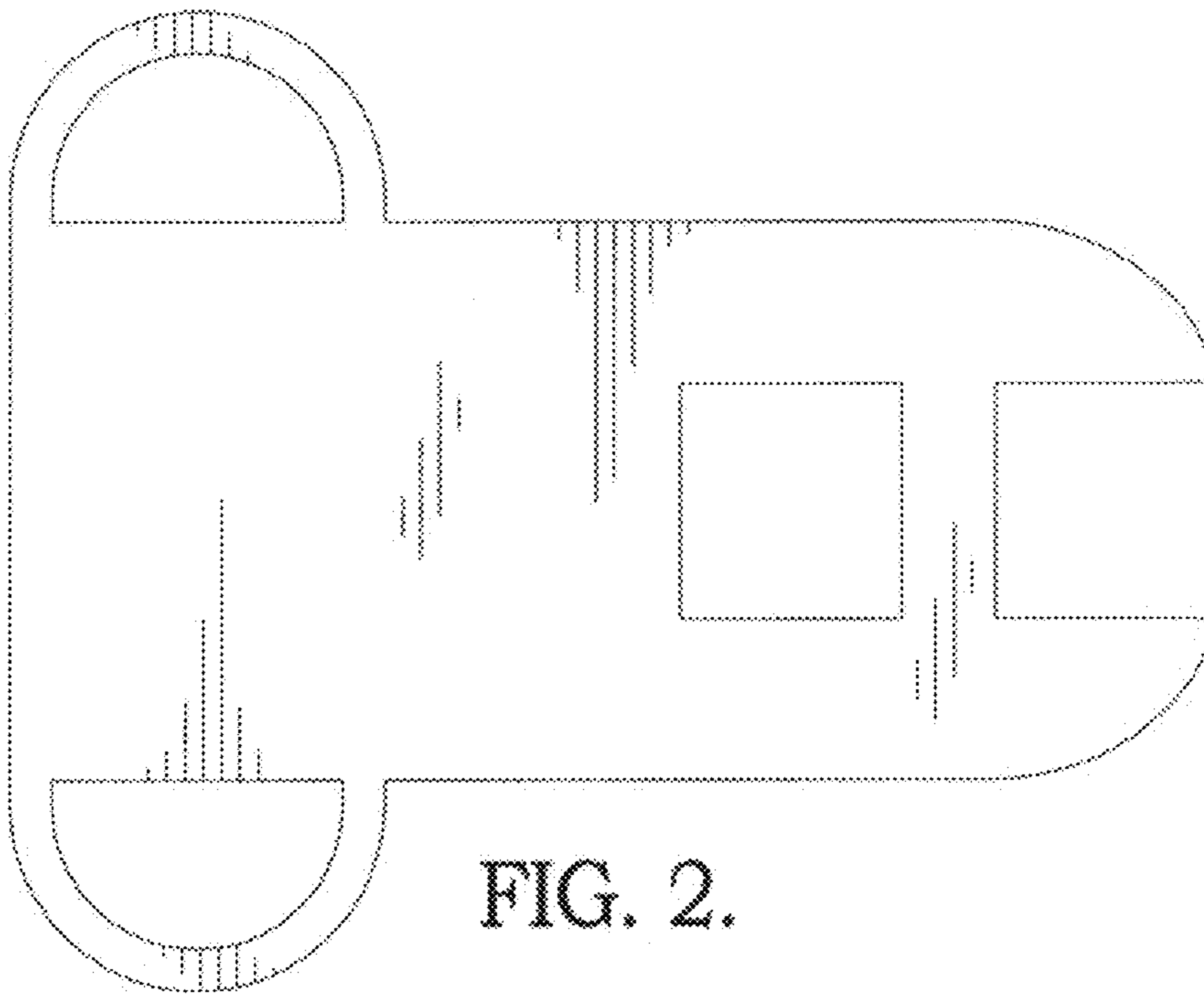

FIG. 2.



FIG. 3.



FIG. 4.



FIG. 5.

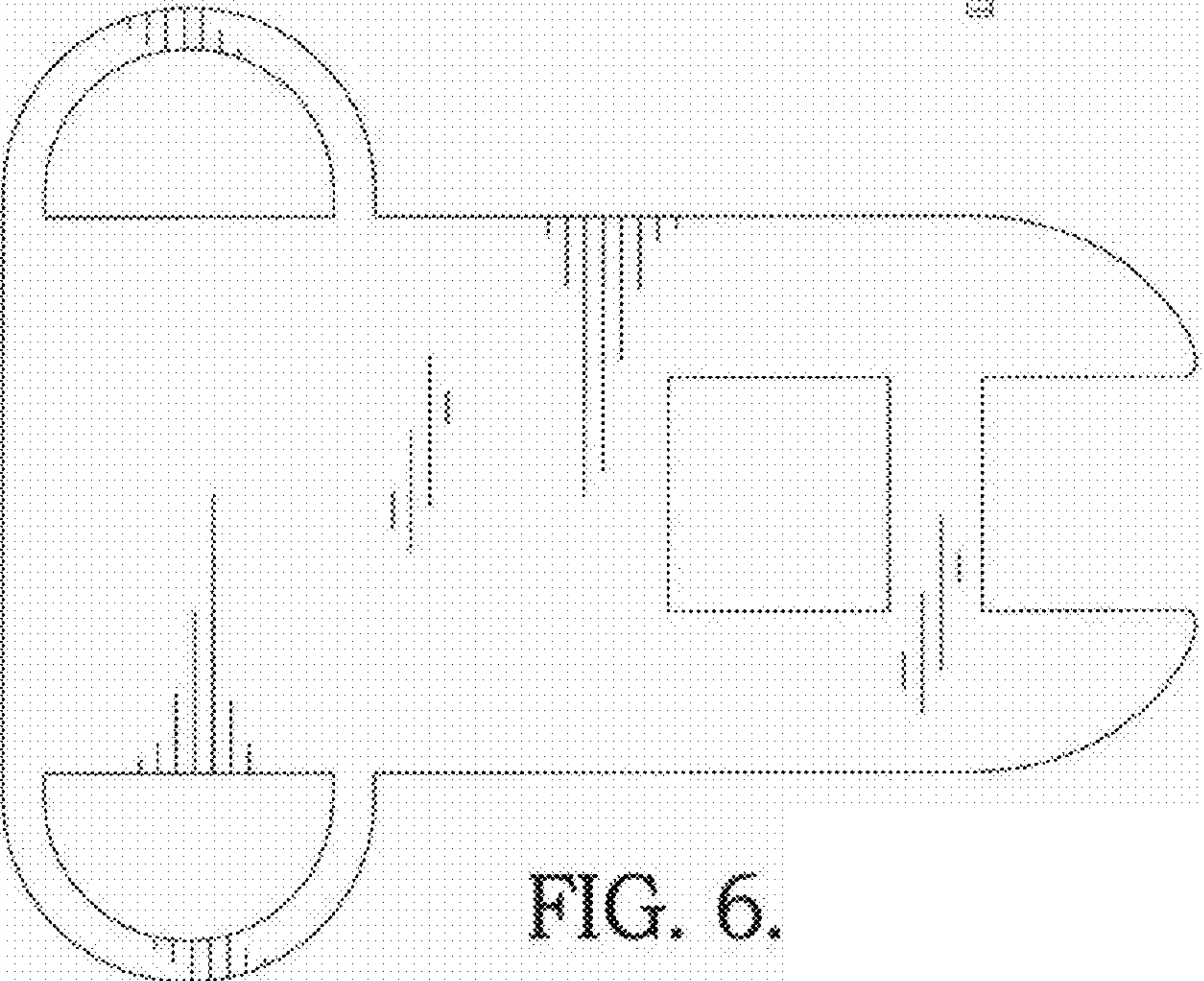

FIG. 6.



FIG. 7.