



US00D683799S

(12) **United States Design Patent**
Kiecker

(10) **Patent No.:** **US D683,799 S**
(45) **Date of Patent:** **** Jun. 4, 2013**

(54) **SET OF TOY BLOCKS**

(76) Inventor: **Kamille Kiecker**, Berwyn, IL (US)

(**) Term: **14 Years**

(21) Appl. No.: **29/387,777**

(22) Filed: **Mar. 17, 2011**

(51) **LOC (9) Cl.** **21-01**

(52) **U.S. Cl.**
USPC **D21/484**

(58) **Field of Classification Search**
USPC D21/386, 389, 404, 468, 470, 471,
D21/479, 484-505; 446/69, 85, 102-128;
434/208, 259, 403; 273/153 R, 156, 157 R,
273/160, 276; D25/113-116, 118
See application file for complete search history.

(56) **References Cited**

U.S. PATENT DOCUMENTS

1,565,901 A * 12/1925 Brandt 273/153 P
1,578,225 A * 3/1926 White 434/238

(Continued)

Primary Examiner — Cynthia M Chin

(74) *Attorney, Agent, or Firm* — QuickPatents; Kevin Prince

(57) **CLAIM**

The ornamental design for a set of toy blocks, as shown and described.

DESCRIPTION

FIG. 1 is a perspective view of a set of toy blocks, showing the new design in an assembled configuration;
FIG. 2 is a front elevational view thereof, a base omitted for clarity of illustration, the rear elevational view, left-side elevational view, and right-side elevational view all being a mirror image thereof;
FIG. 3 is a top plan view of FIG. 2;
FIG. 4 is a bottom plan view of FIG. 2;

FIG. 5 is a perspective view of the base, the blocks omitted for clarity of illustration;
FIG. 6 is a front elevational view of FIG. 5, the rear elevational view, left-side elevational view, and right-side elevational view all being a mirror image thereof;
FIG. 7 is a top plan view of FIG. 5;
FIG. 8 is a bottom plan view of FIG. 5;
FIG. 9 is a perspective view of a first block of the design, the remaining blocks and base omitted for clarity of illustration;
FIG. 10 is a front elevational view of FIG. 9;
FIG. 11 is a rear elevational view of FIG. 9;
FIG. 12 is a left-side elevational view of FIG. 9;
FIG. 13 is a right-side elevational view of FIG. 9;
FIG. 14 is a top plan view of FIG. 9, the bottom plan view being a mirror image thereof;
FIG. 15 is a perspective view of a second block of the design, the remaining blocks and base omitted for clarity of illustration;
FIG. 16 is a front elevational view of FIG. 15, the right-side elevational view being a mirror image thereof;
FIG. 17 is a left-side elevational view of FIG. 15, the rear elevational view being a mirror image thereof;
FIG. 18 is a top plan view of FIG. 15;
FIG. 19 is a bottom plan view of FIG. 15;
FIG. 20 is a perspective view of a third block of the design, the remaining blocks and base omitted for clarity of illustration;
FIG. 21 is a front elevational view of FIG. 20, the rear elevational view, left-side elevational view, and right-side elevational view all being a mirror image thereof;
FIG. 22 is a top plan view of FIG. 20, the bottom plan view being a mirror image thereof;
FIG. 23 is a perspective view of a fourth block of the design, the remaining blocks and base omitted for clarity of illustration;
FIG. 24 is a front elevational view of FIG. 23;
FIG. 25 is a rear elevational view of FIG. 23;
FIG. 26 is a left-side elevational view of FIG. 23;
FIG. 27 is a right-side elevational view of FIG. 23;
FIG. 28 is a top plan view of FIG. 23; and,
FIG. 29 is a bottom plan view of FIG. 23.
Portions of the set of toy blocks shown in broken lines in FIGS. 4 and 8 form no part of the claimed design.

1 Claim, 8 Drawing Sheets

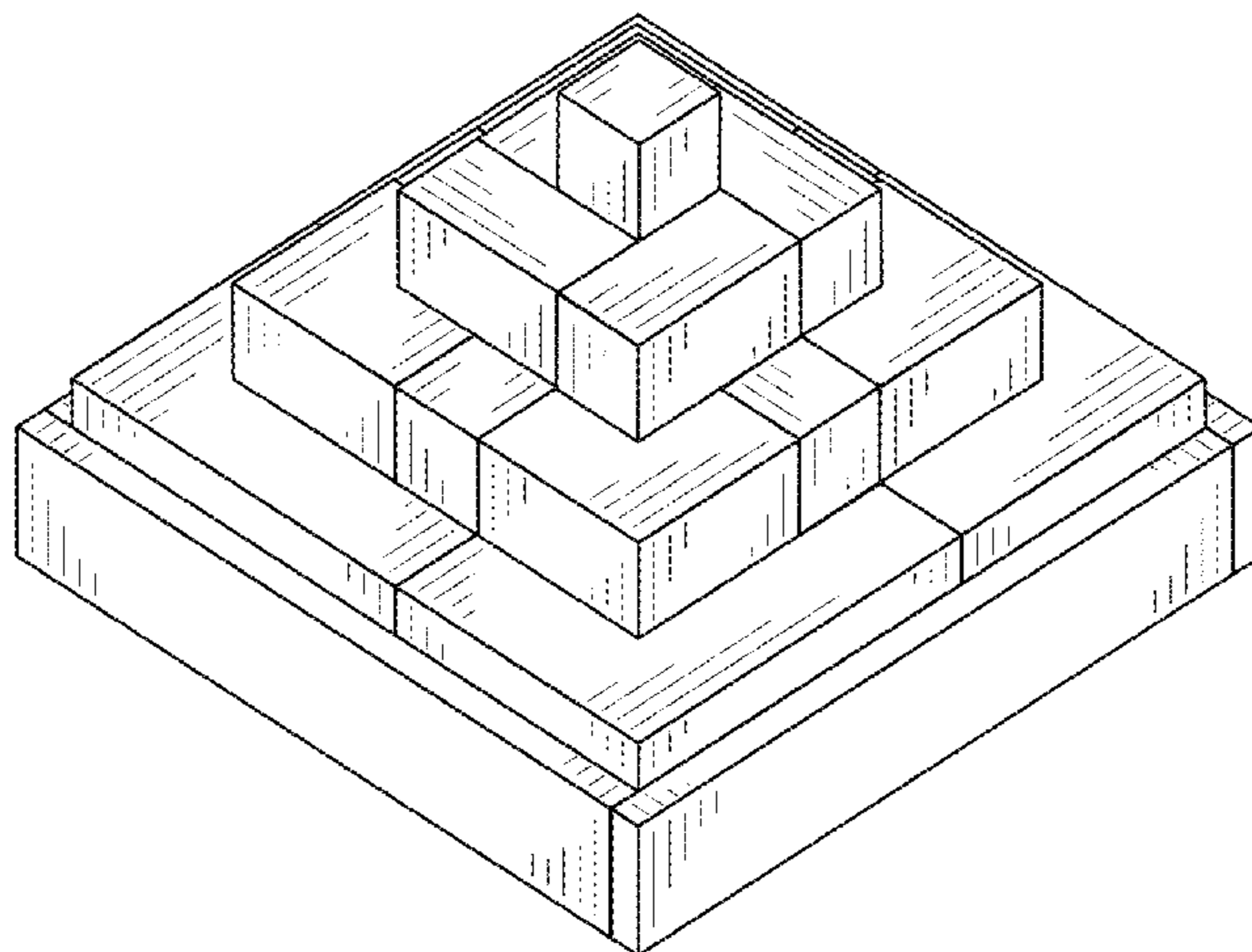

US D683,799 S

Page 2

U.S. PATENT DOCUMENTS

| | | | | | | | | | |
|-----------|------|---------|----------------|-------|-----------|--|--|--|--|
| 3,546,792 | A * | 12/1970 | Sherman | | 434/96 | | | | |
| 4,121,831 | A * | 10/1978 | Greene | | 273/160 | | | | |
| 4,133,538 | A * | 1/1979 | Ambrose | | 273/276 | | | | |
| 4,153,254 | A * | 5/1979 | Marc | | 273/160 | | | | |
| 4,323,245 | A * | 4/1982 | Beaman | | 273/157 R | | | | |
| 4,534,563 | A * | 8/1985 | Guenther | | 273/157 R | | | | |
| 4,662,638 | A * | 5/1987 | Vachek | | 273/160 | | | | |
| 4,844,466 | A * | 7/1989 | Johnson et al. | | 273/157 R | | | | |
| 4,934,701 | A * | 6/1990 | Ting | | 273/157 R | | | | |
| 5,221,223 | A * | 6/1993 | Kao | | 446/85 | | | | |
| D342,103 | S * | 12/1993 | Wong | | D21/479 | | | | |
| 5,407,201 | A * | 4/1995 | Whitehurst | | 273/157 R | | | | |
| D369,630 | S * | 5/1996 | Balanchi | | D21/479 | | | | |
| D370,700 | S * | 6/1996 | Henrichsen | | D21/500 | | | | |
| D375,330 | S * | 11/1996 | Ritzman | | D21/479 | | | | |
| 5,762,529 | A * | 6/1998 | Nizza | | 446/85 | | | | |
| 5,928,052 | A * | 7/1999 | Buscher | | 446/124 | | | | |
| D473,349 | S * | 4/2003 | Willinger | | D30/160 | | | | |
| 6,648,330 | B2 * | 11/2003 | Porter | | 273/153 R | | | | |
| 6,790,118 | B2 * | 9/2004 | Ahn | | 446/125 | | | | |
| 6,910,691 | B2 * | 6/2005 | Shih | | 273/157 R | | | | |

* cited by examiner

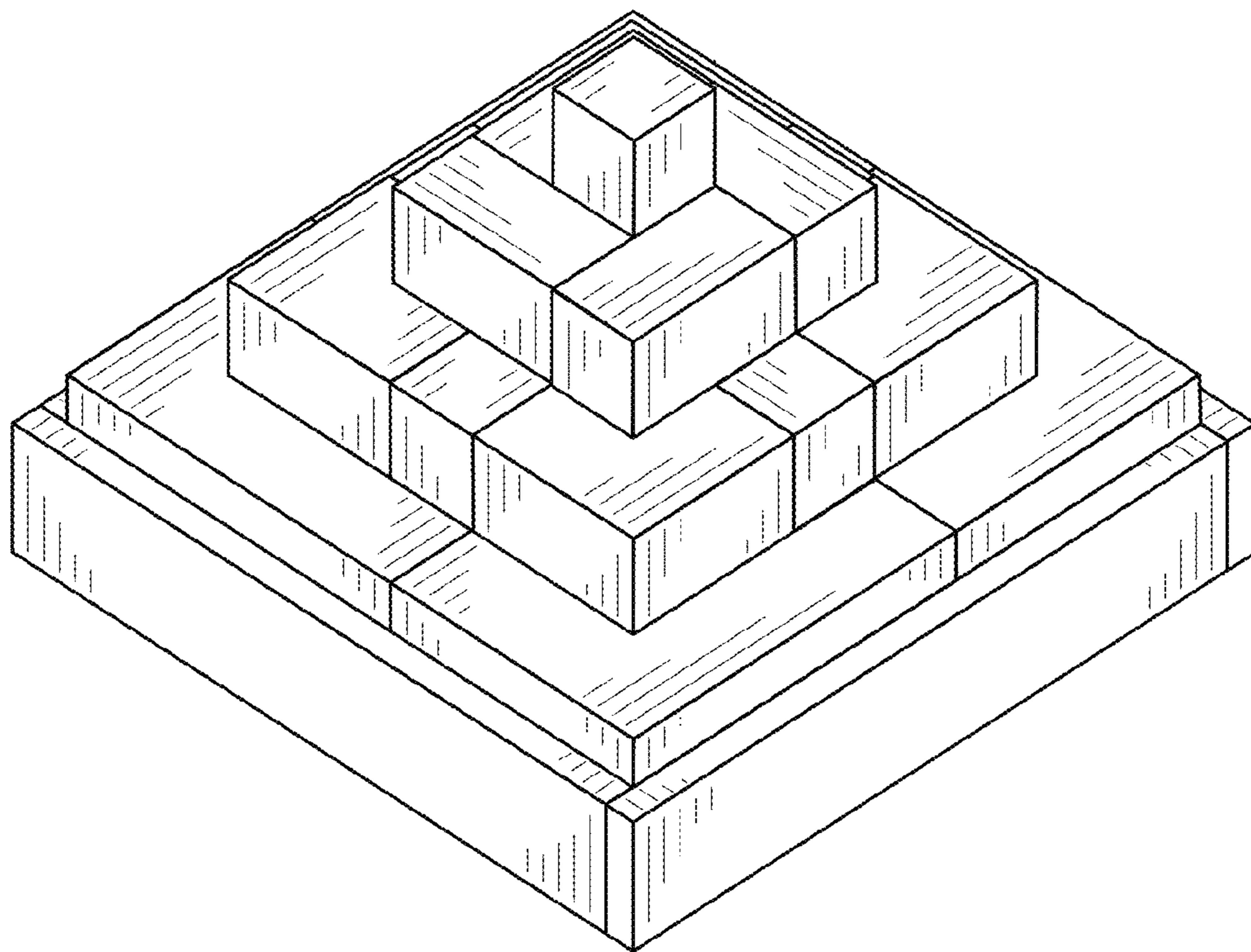

FIG. 1

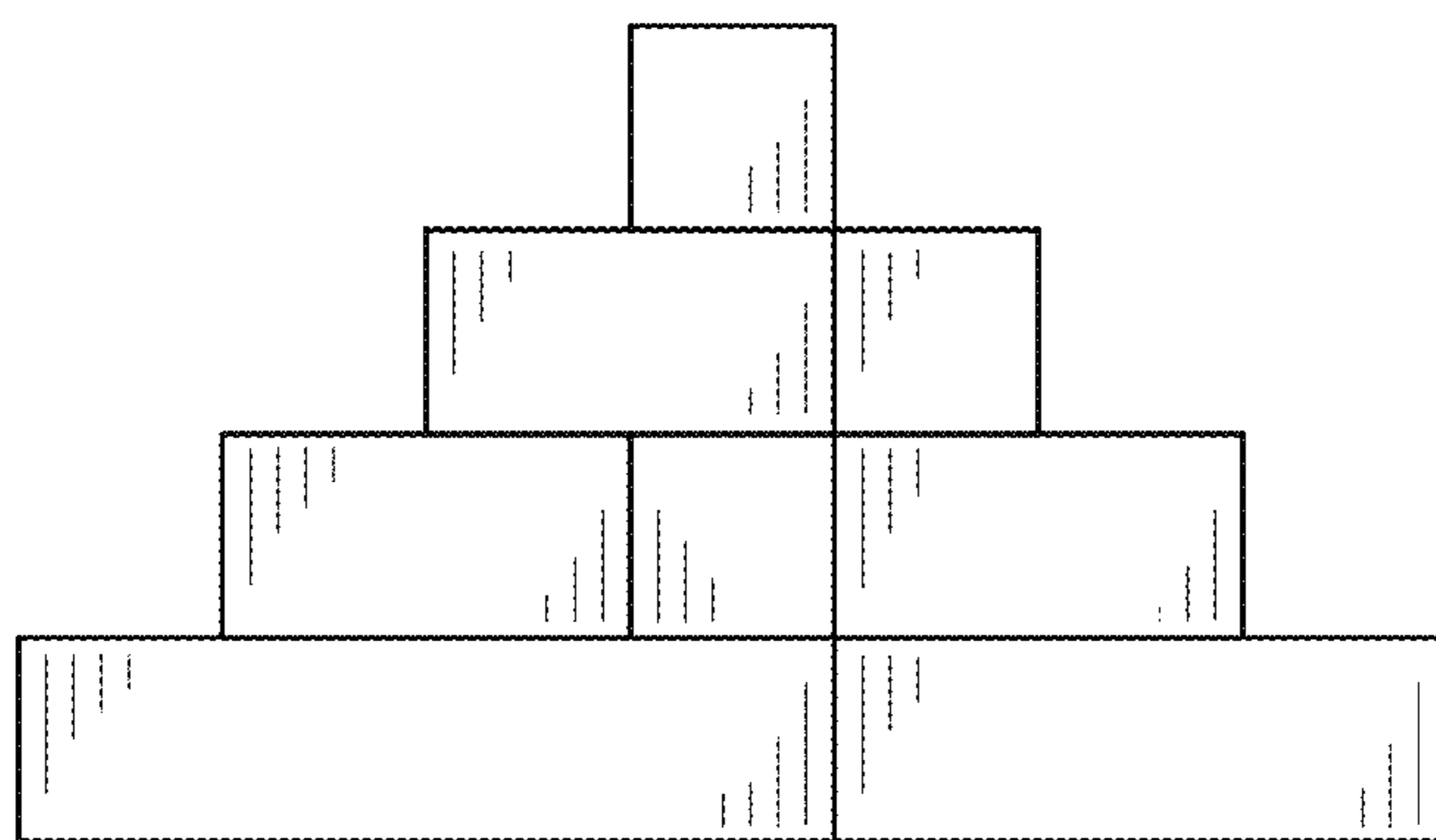

FIG. 2

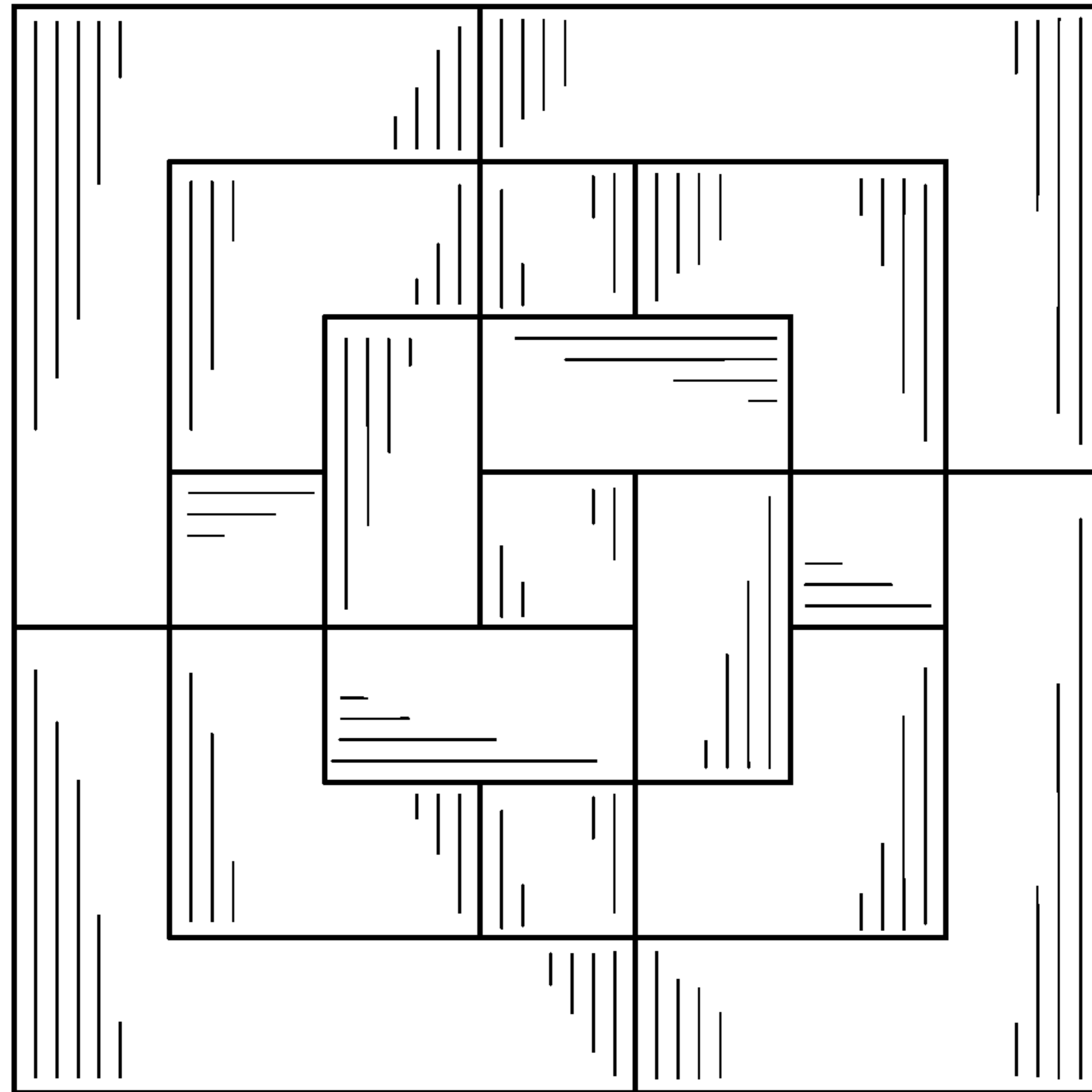

FIG. 3

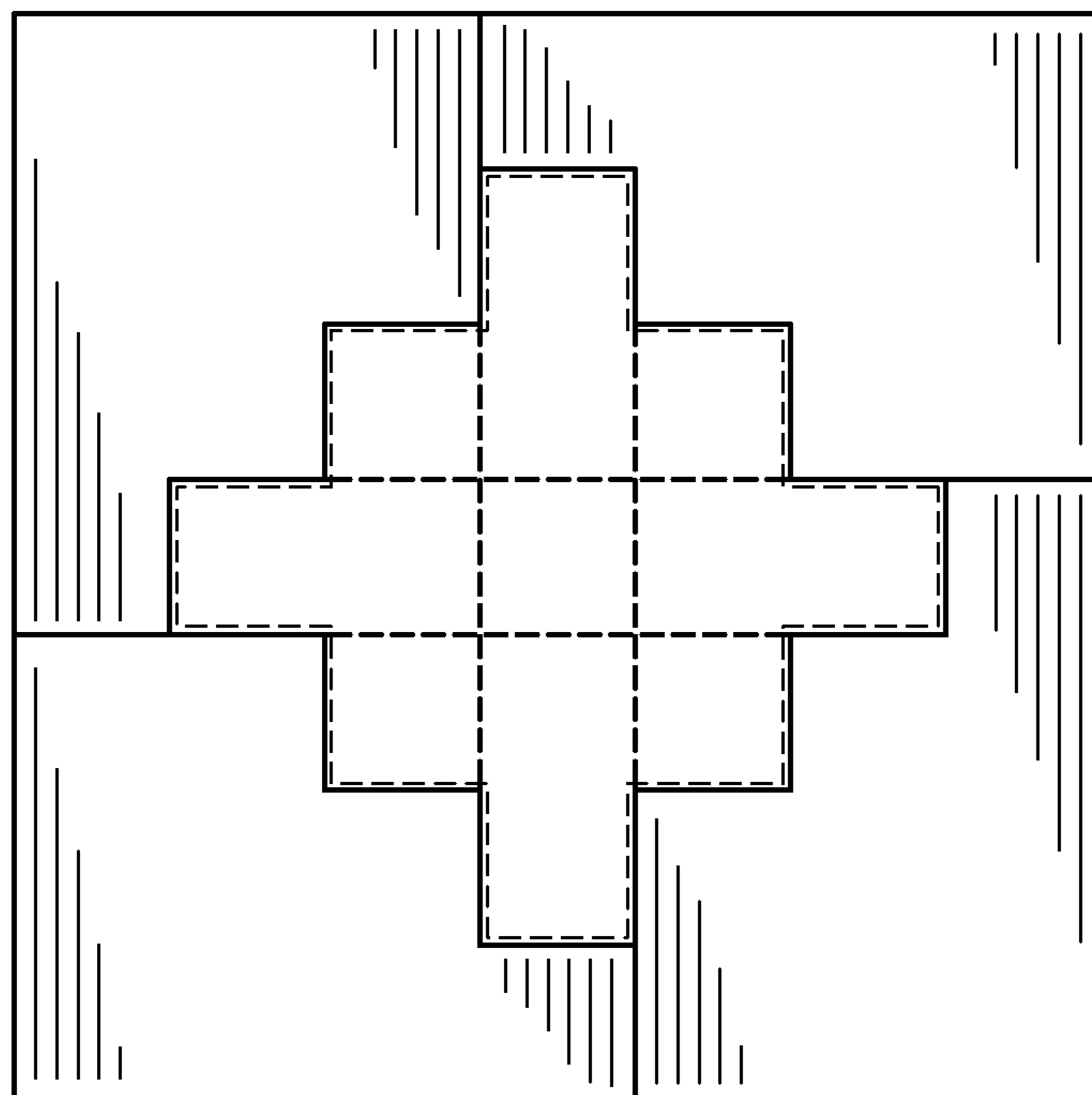

FIG. 4

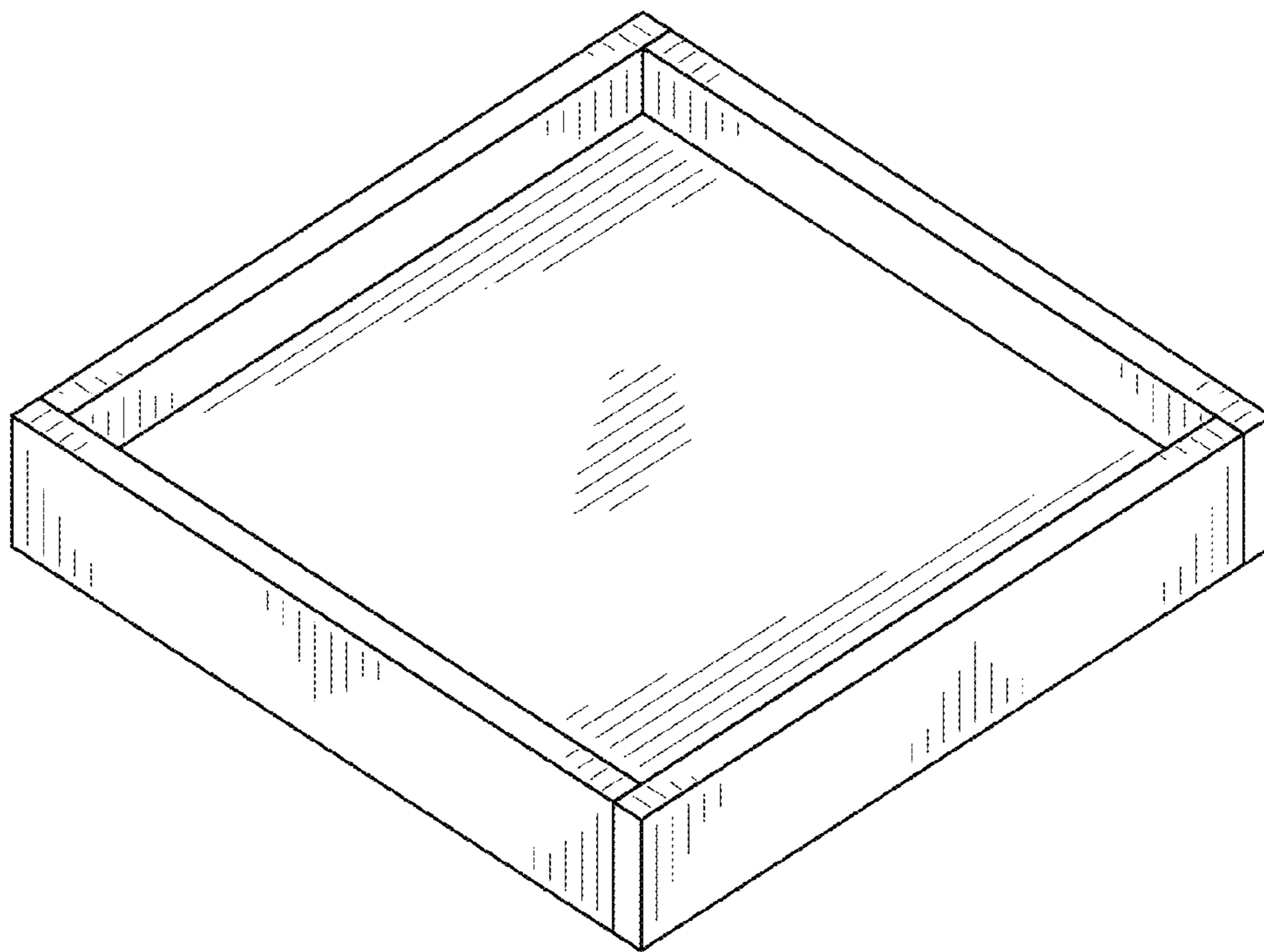

FIG. 5

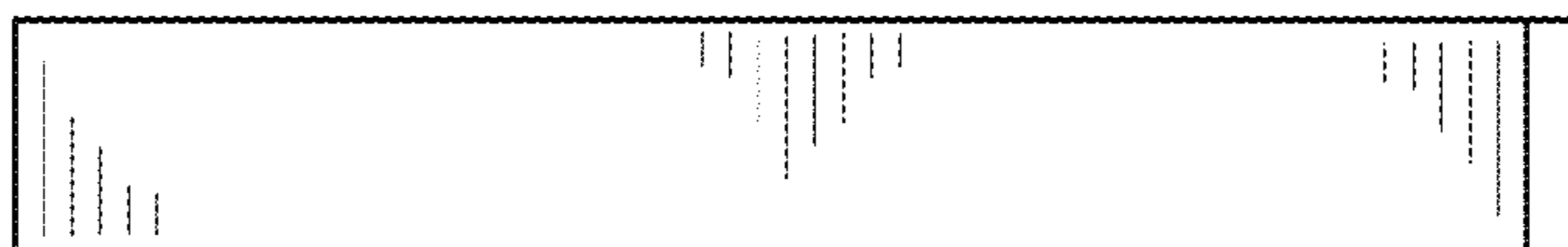

FIG. 6

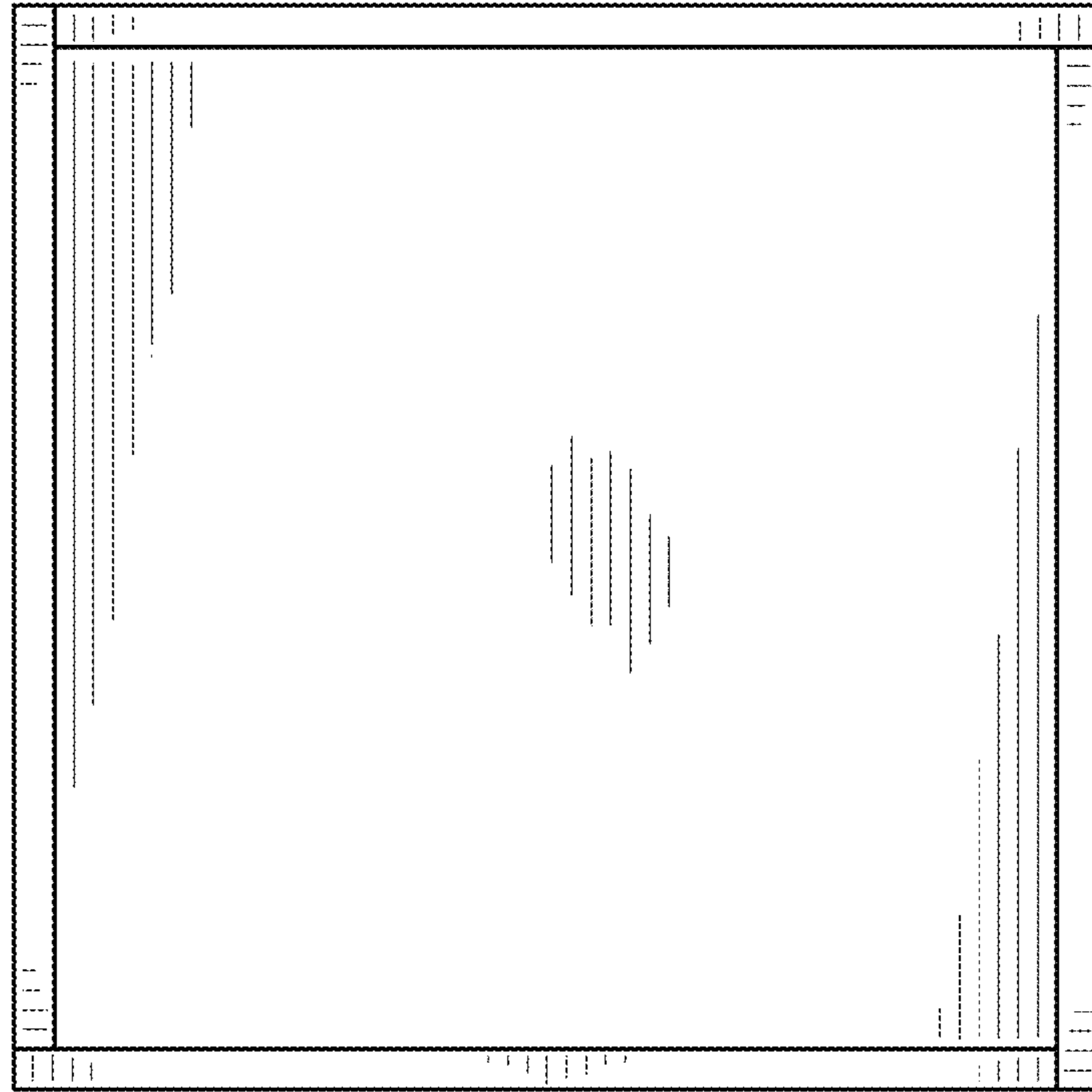

FIG. 7

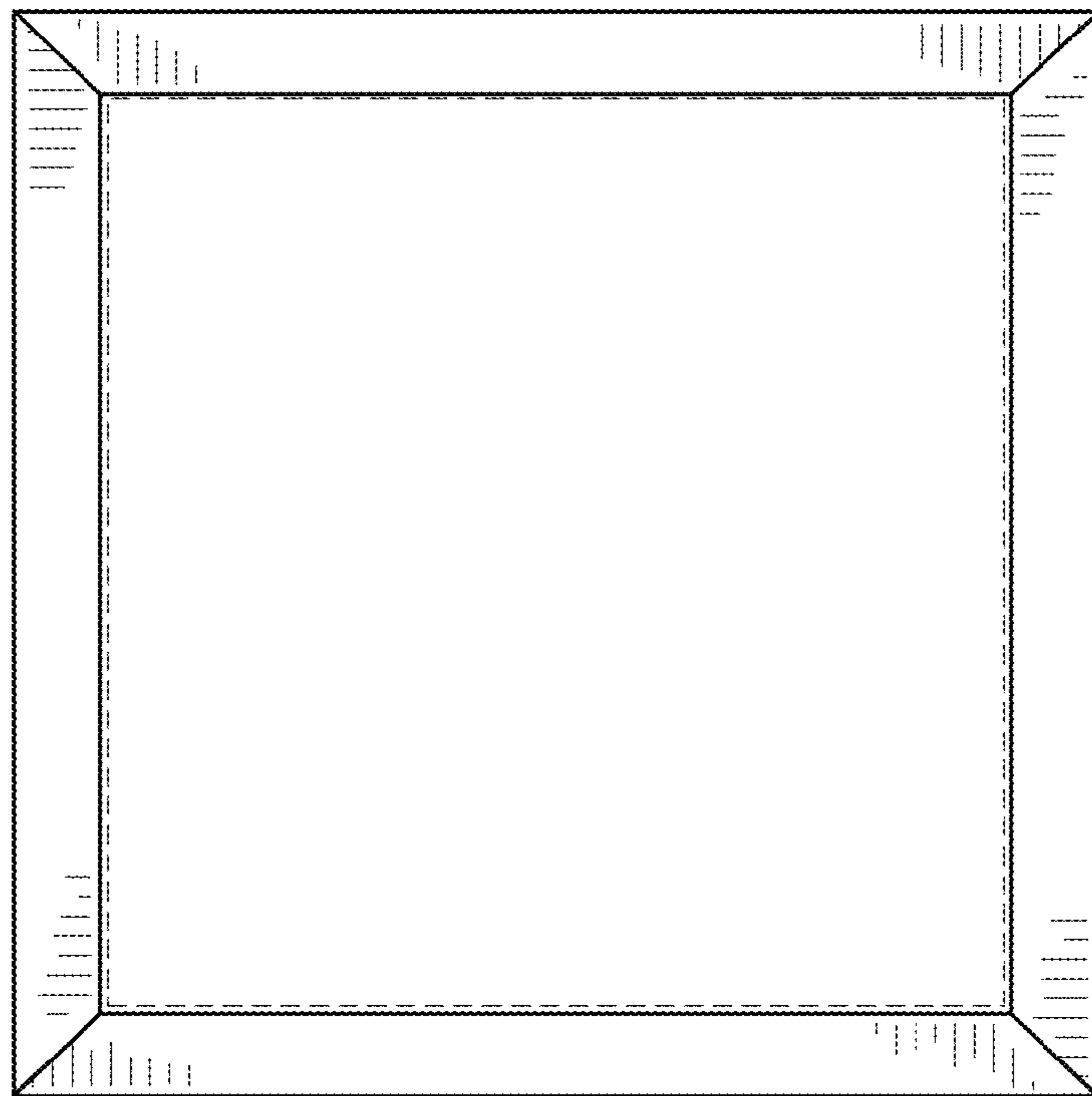

FIG. 8

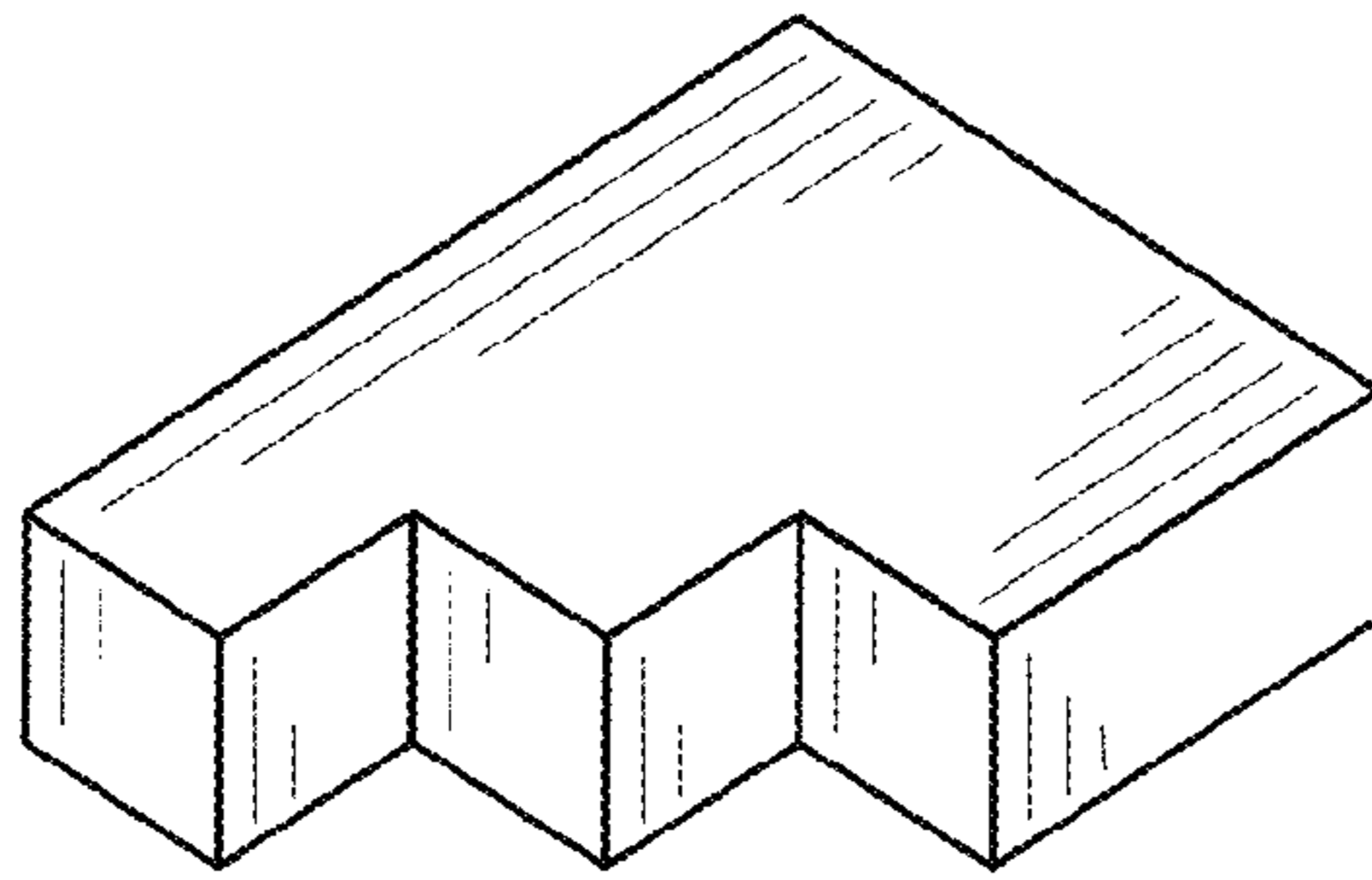

FIG. 9

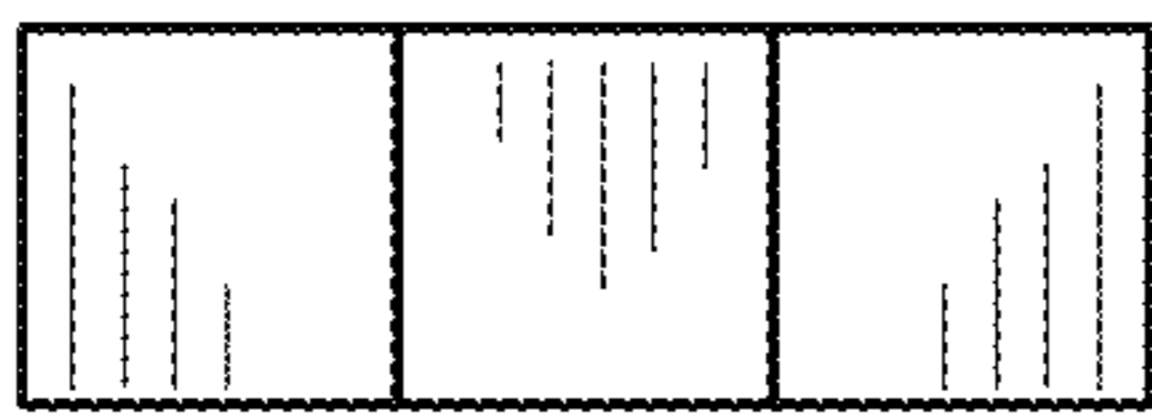

FIG. 10



FIG. 11

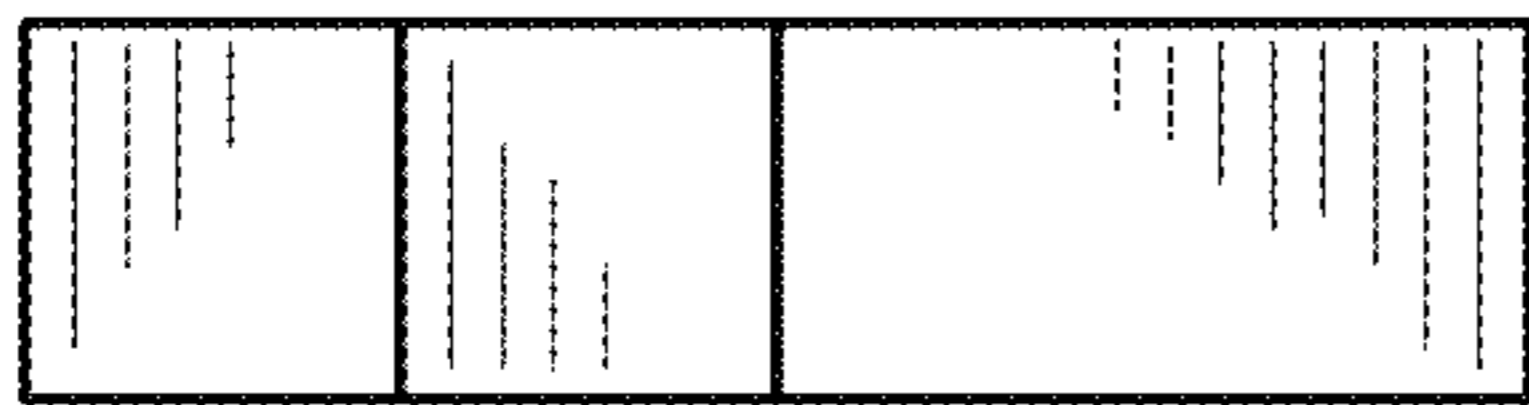

FIG. 12



FIG. 13

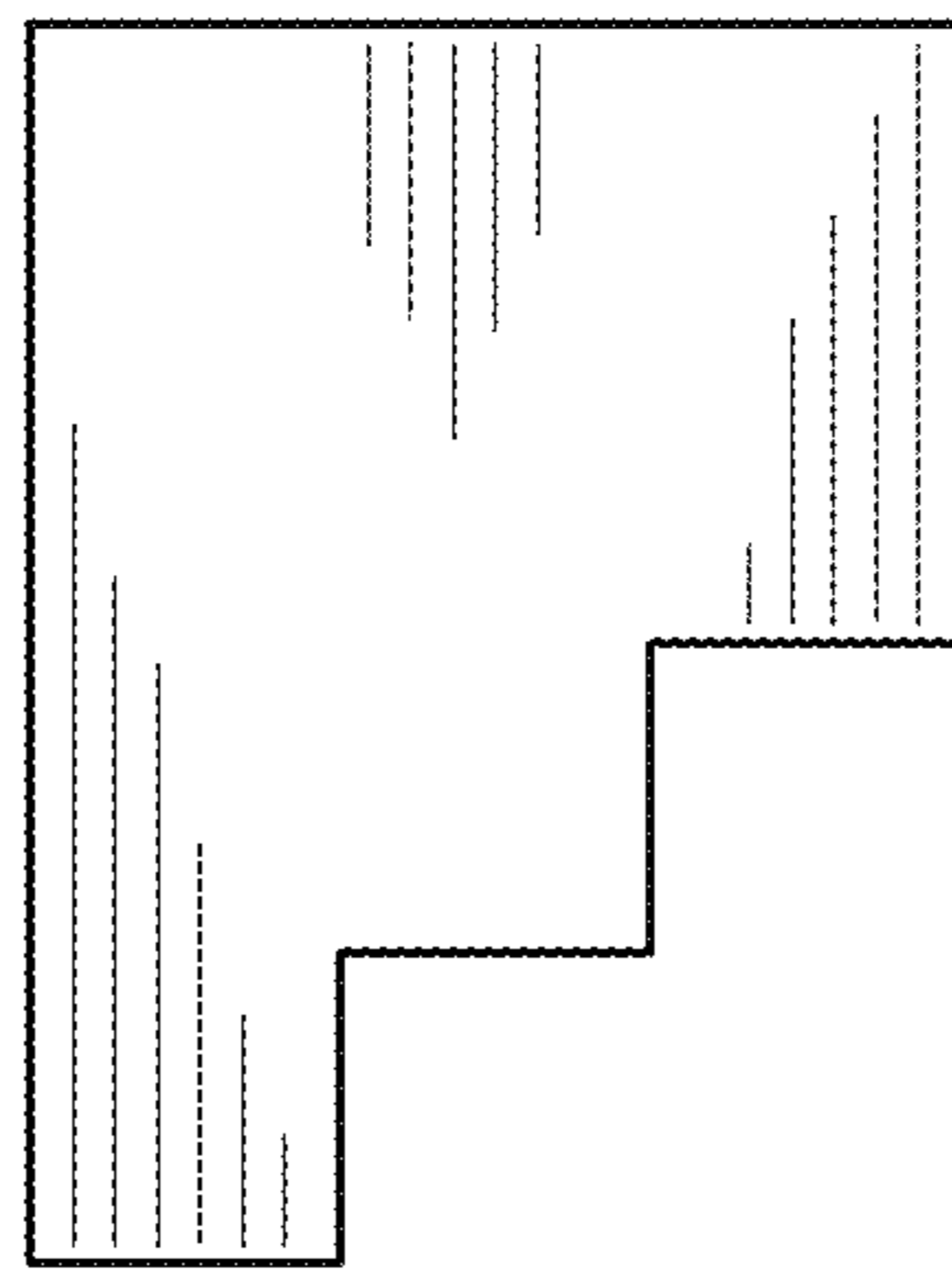

FIG. 14

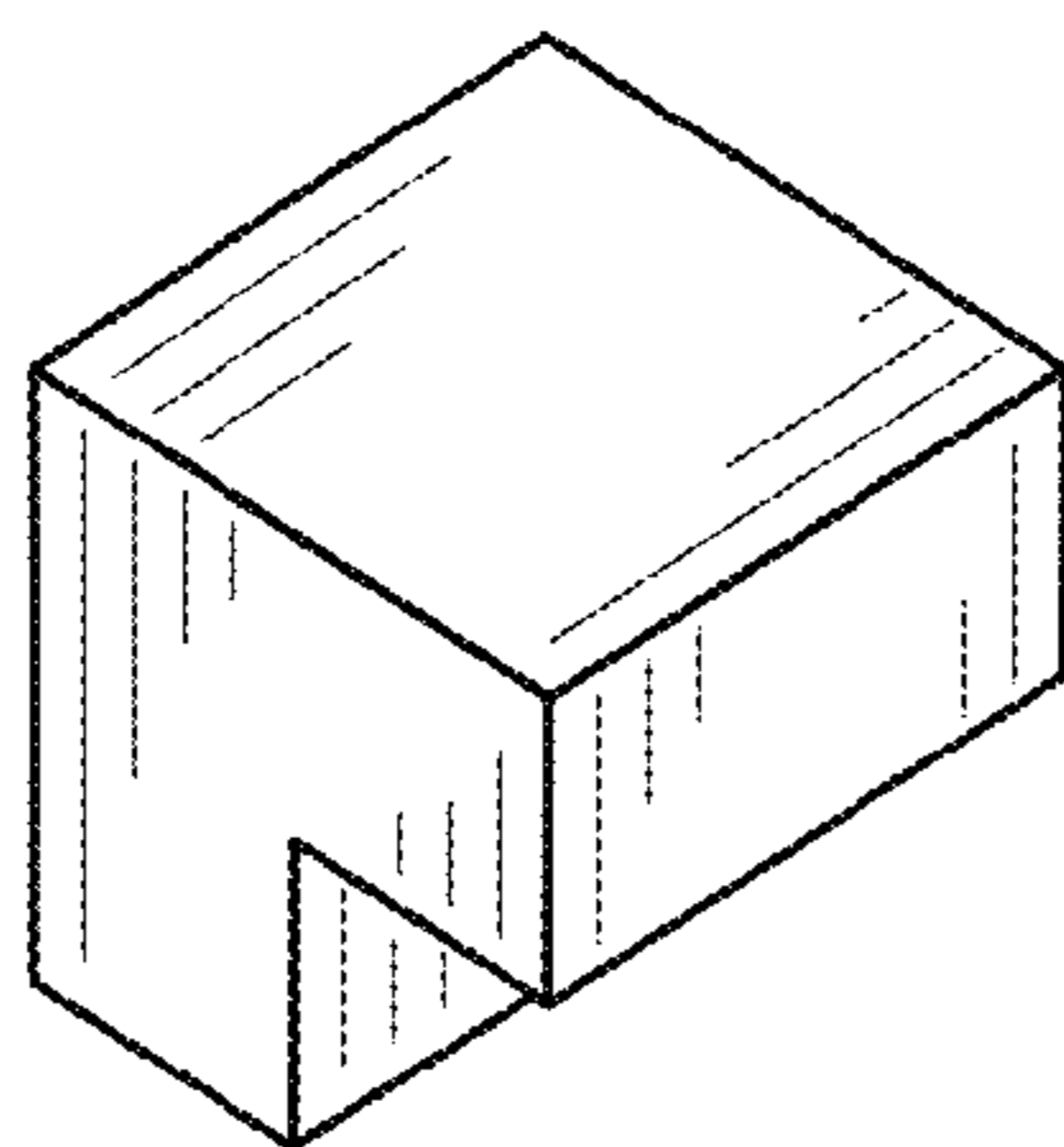

FIG. 15

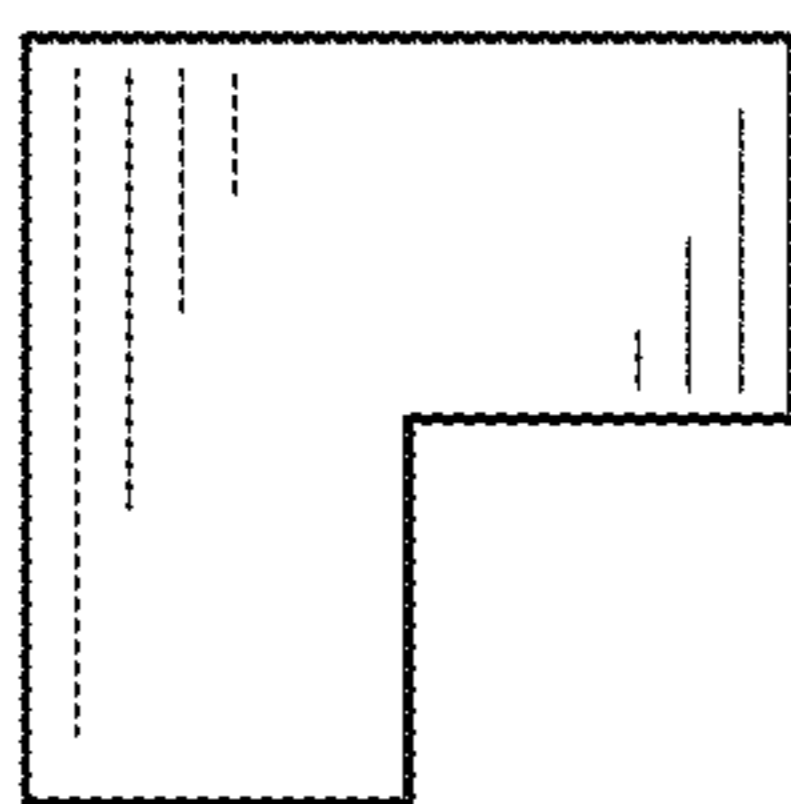

FIG. 16

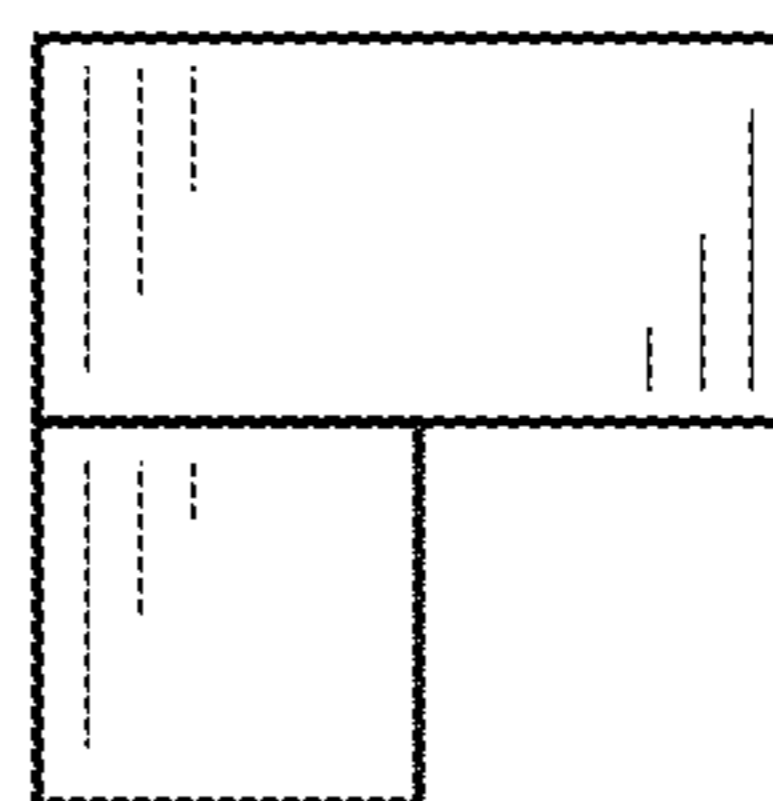

FIG. 17

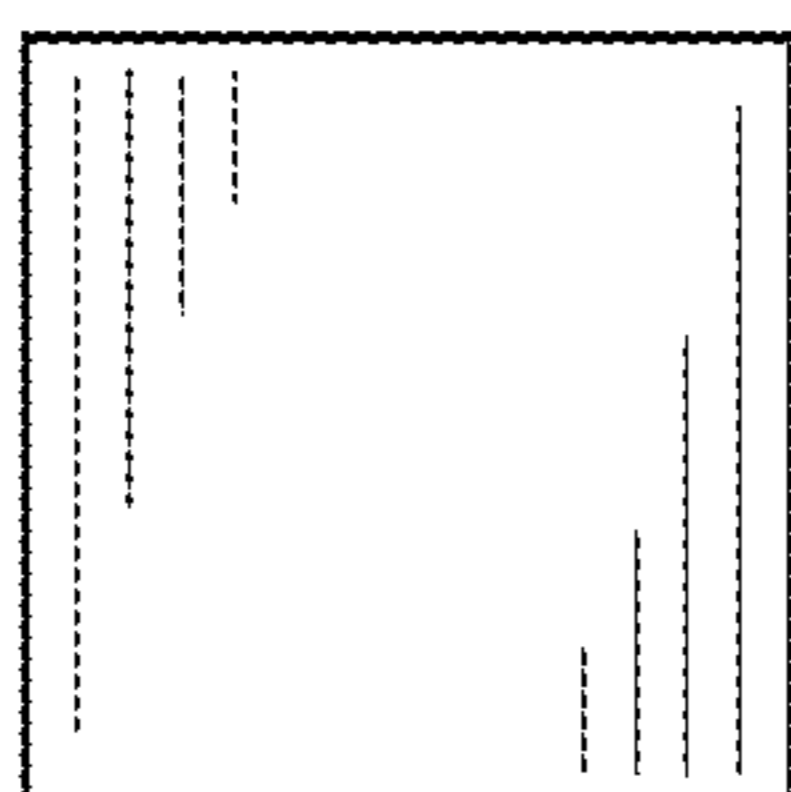

FIG. 18

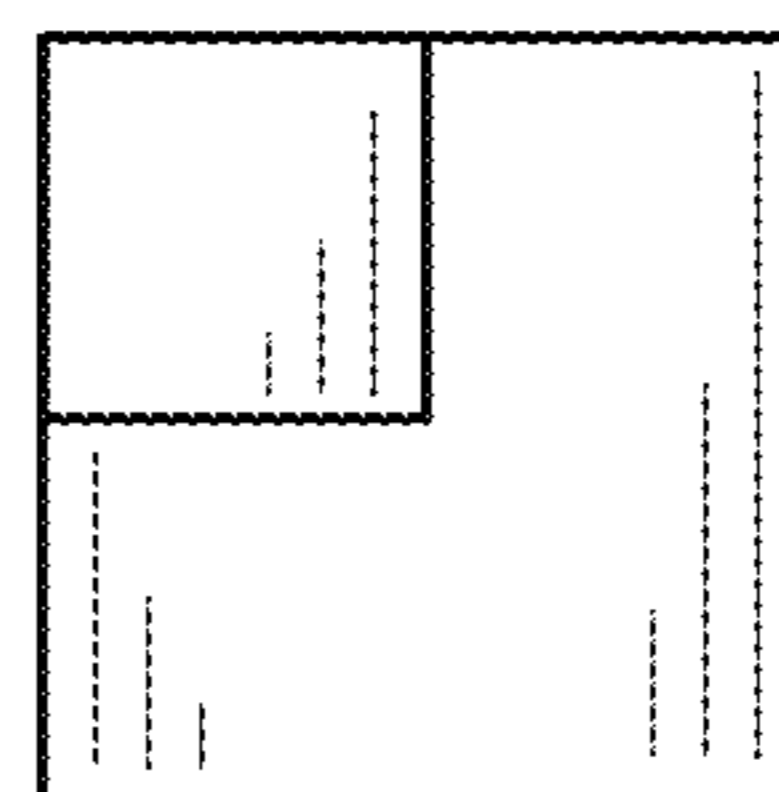

FIG. 19

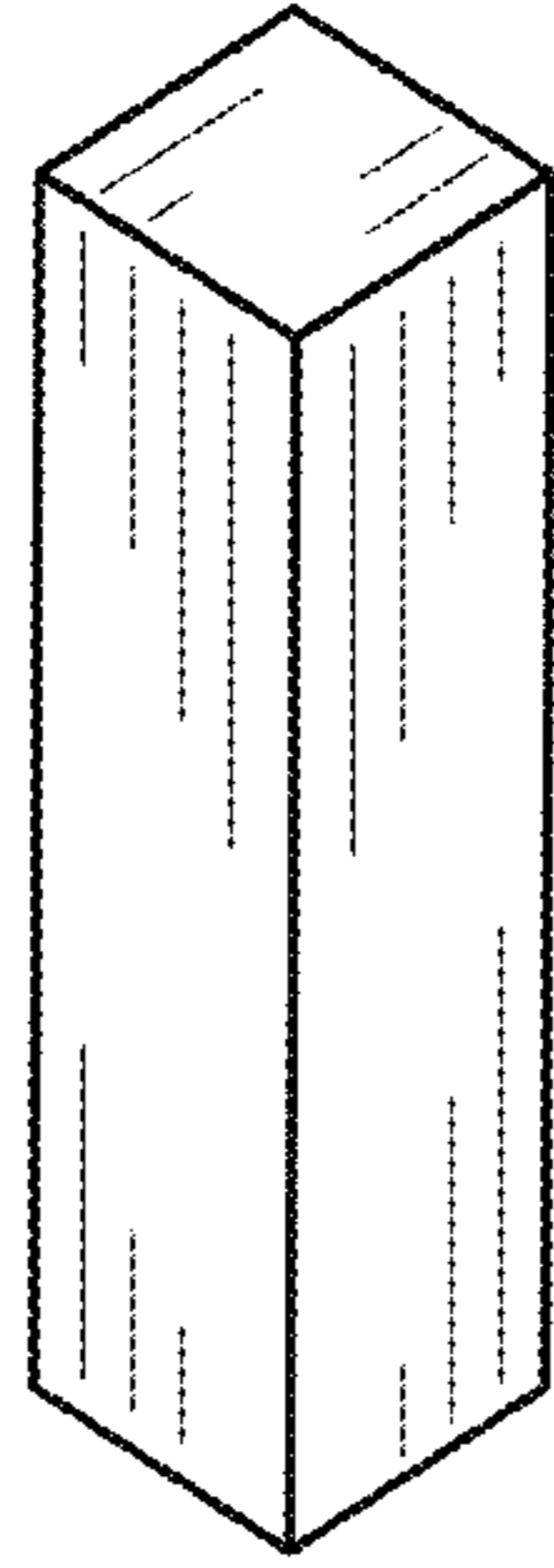

FIG. 20

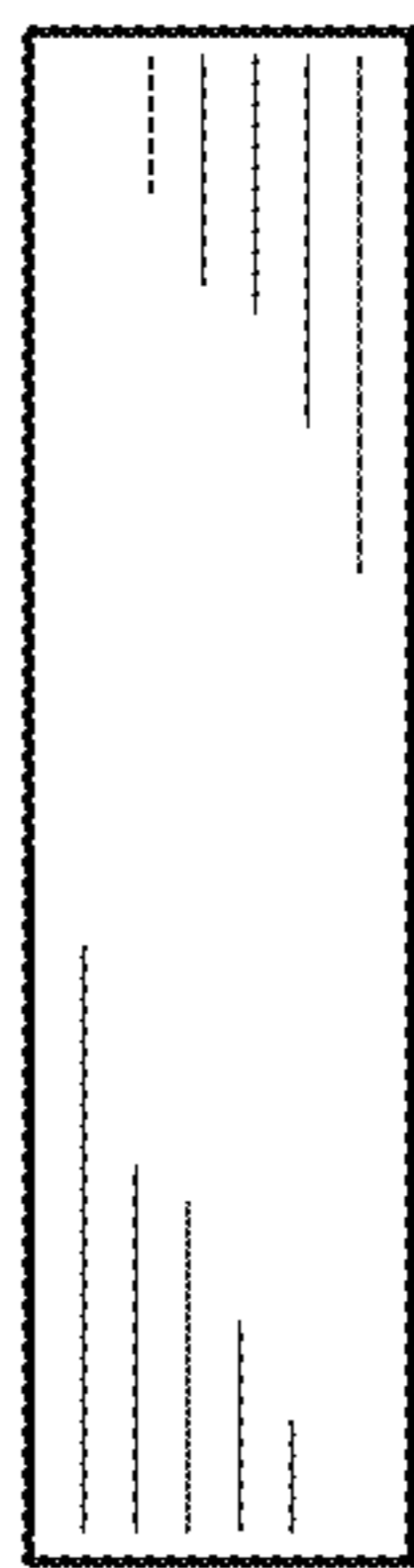

FIG. 21

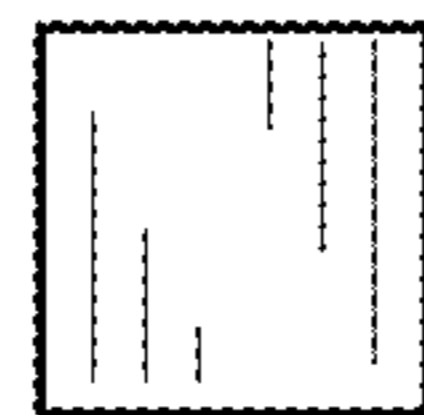

FIG. 22

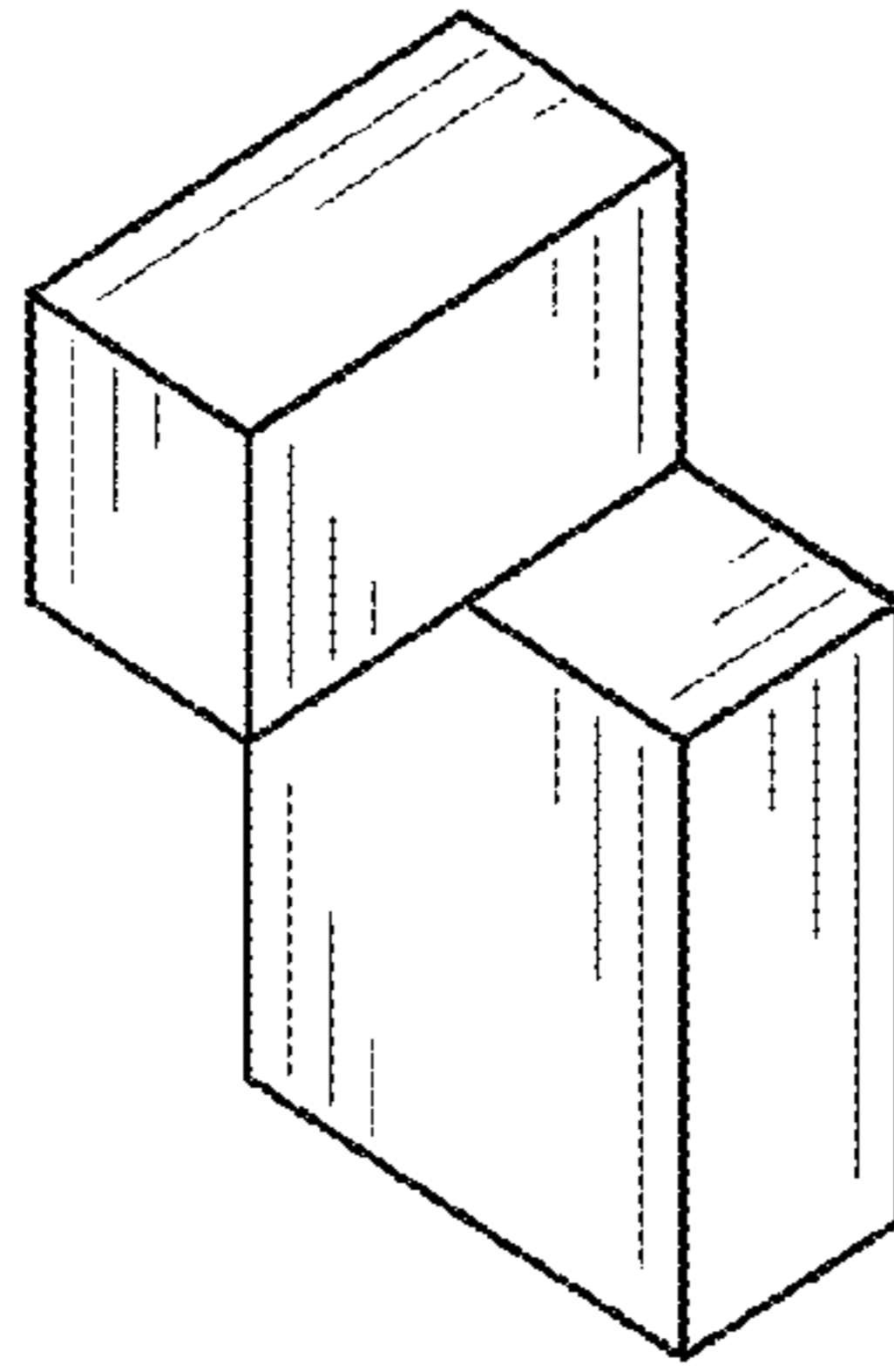

FIG. 23

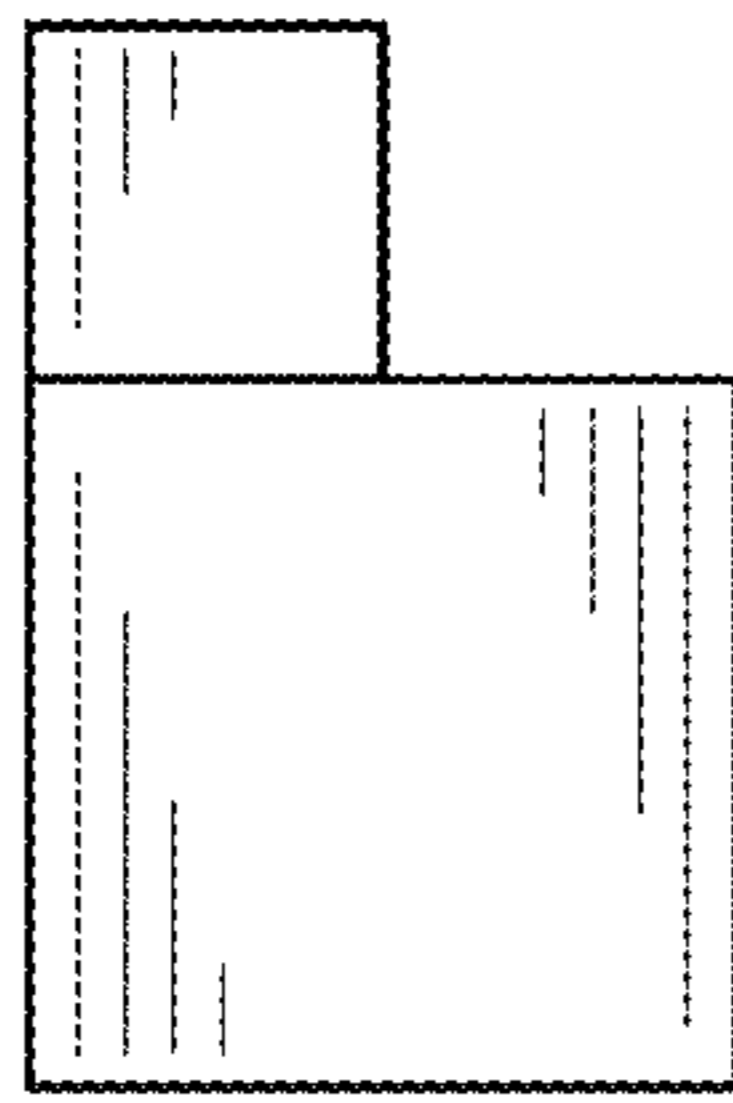

FIG. 24

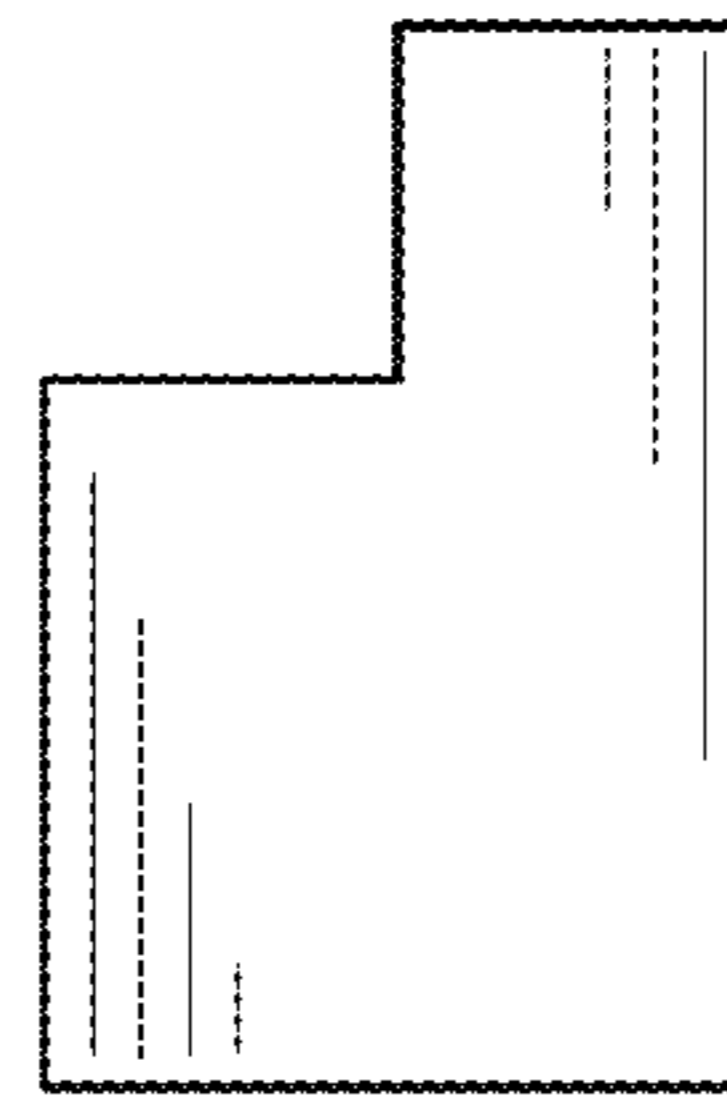

FIG. 25

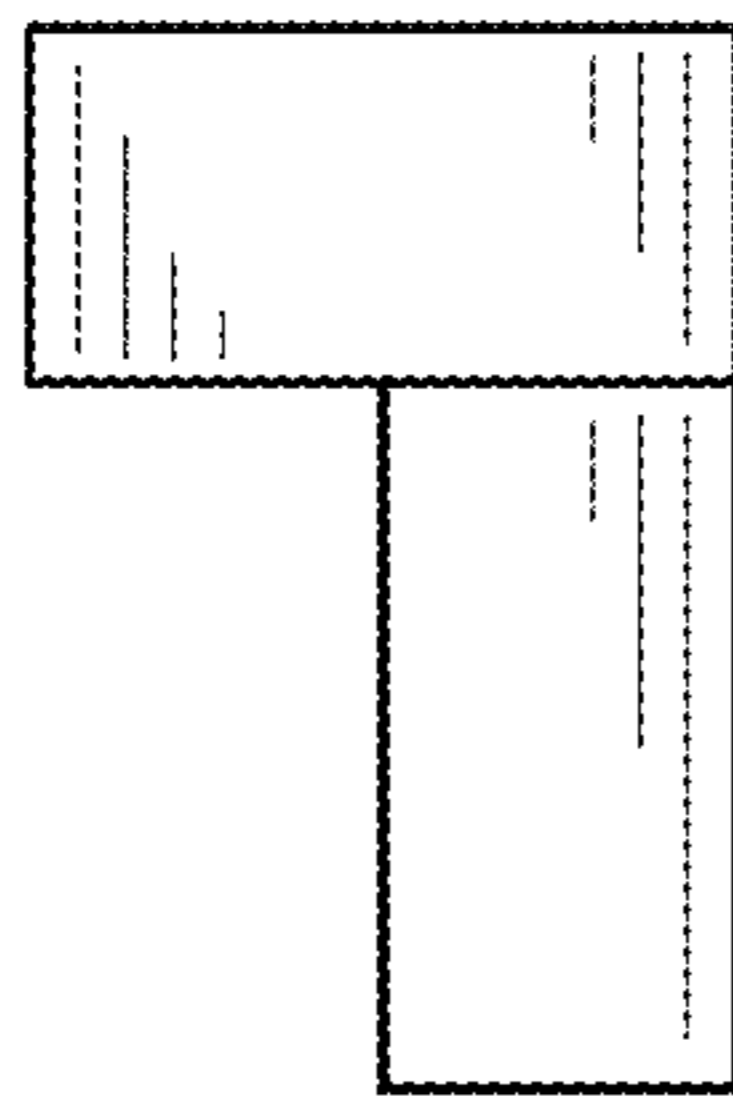

FIG. 26

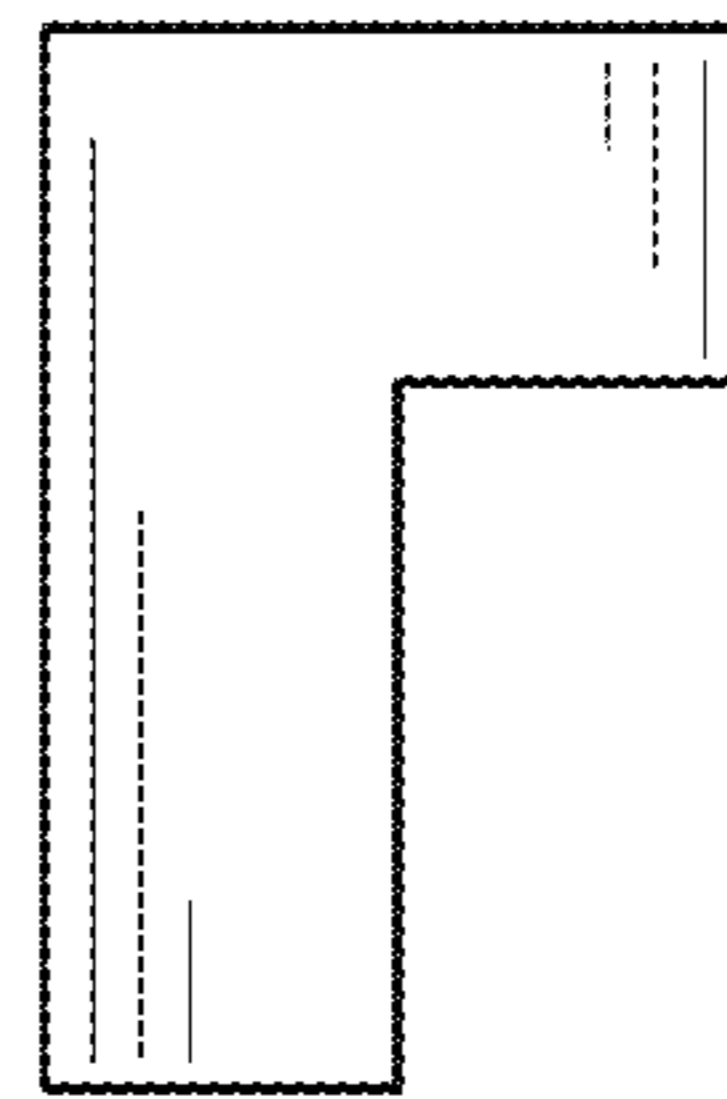

FIG. 27

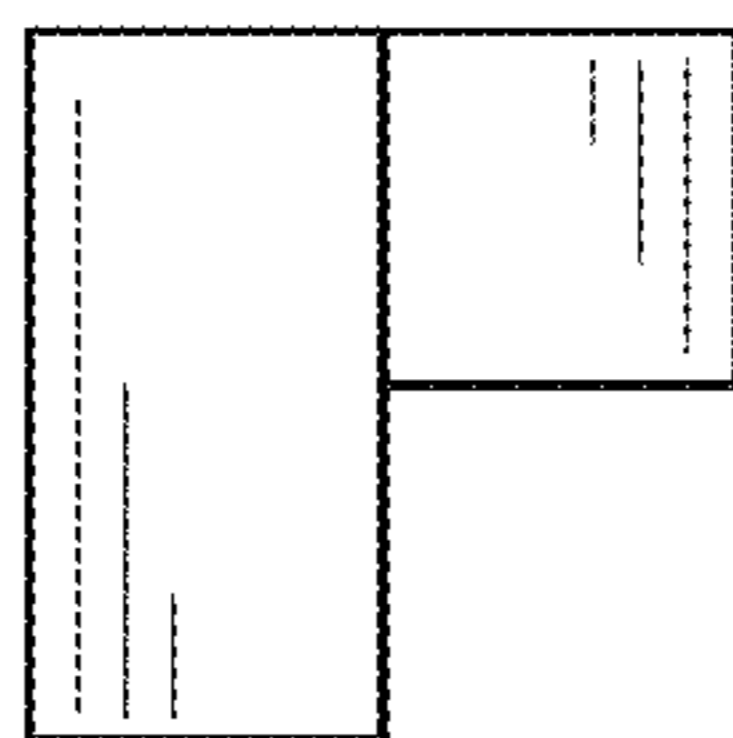

FIG. 28

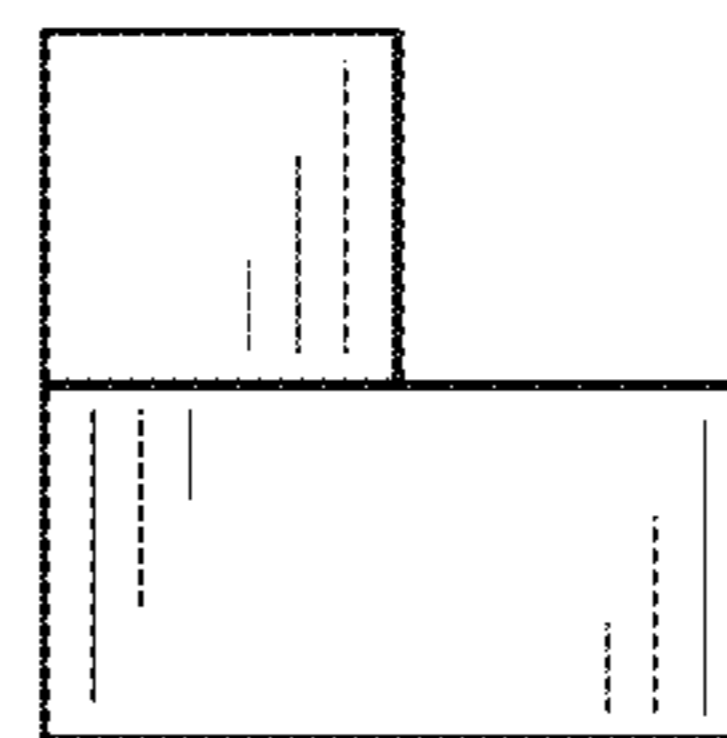

FIG. 29