



US00D683737S

(12) **United States Design Patent**
Brinda et al.

(10) **Patent No.:** **US D683,737 S**
(45) **Date of Patent:** **** Jun. 4, 2013**

(54) **DISPLAY SCREEN WITH GRAPHICAL USER INTERFACE**

D638,441 S * 5/2011 Ording et al. D14/489
D638,842 S * 5/2011 Woods et al. D14/486

(Continued)

(75) Inventors: **David Brinda**, Washington, WA (US);
Sheng-Hsin Huang, Taoyuan County (TW); **Jye Rong**, Taoyuan County (TW);
Yi-Min Chien, Taoyuan County (TW)

FOREIGN PATENT DOCUMENTS

DE 40605937-0020 * 3/2007
EM 001268502-0003 * 4/2011

(Continued)

(73) Assignee: **HTC Corporation**, Taoyuan County (TW)

Primary Examiner — Angela J Lee

(74) *Attorney, Agent, or Firm* — Jianq Chyun IP Office

(**) Term: **14 Years**

(21) Appl. No.: **29/388,004**

(22) Filed: **Mar. 23, 2011**

(51) **LOC (9) Cl.** **14-04**

(52) **U.S. Cl.**
USPC **D14/485**

(58) **Field of Classification Search**

USPC D14/485-495; 715/202, 212, 246,
715/715, 716, 718, 719, 723, 726, 730, 731,
715/732, 764, 768, 779, 780, 782, 792, 793,
715/808, 809, 810, 811, 812, 813, 821, 822,
715/823, 825, 828, 830, 833, 835, 838, 840,
715/841, 845, 848, 859, 860, 861, 864, 963,
715/974, 977

See application file for complete search history.

(56) **References Cited**

U.S. PATENT DOCUMENTS

D624,407 S * 9/2010 Straker D9/434
D627,791 S * 11/2010 Lamb et al. D14/489
D629,419 S * 12/2010 Ording et al. D14/489
D633,508 S * 3/2011 Chou et al. D14/485
D636,405 S * 4/2011 Mays et al. D14/495

(57) **CLAIM**

The ornamental design for a display screen with graphic user interface, as shown and described.

DESCRIPTION

FIG. 1 is a front view of the display screen with graphical user interface showing a first image;

FIG. 2 is a front view thereof showing a second image;

FIG. 3 is a front view thereof showing a third image;

FIG. 4 is a front view thereof showing a fourth image;

FIG. 5 is a front view thereof showing a fifth image;

FIG. 6 is a front view thereof showing a sixth image;

FIG. 7 is a front view thereof showing a seventh image;

FIG. 8 is a front view thereof showing an eighth image; and,

FIG. 9 is a front view thereof showing a ninth image.

The broken line showing of portions of the graphic user interface and the broken line showing of the display screen illustrate unclaimed environment and form no part of the claimed design. The appearance of the transitional image sequentially transitions between the images shown in FIGS. 1-9. The process or period in which one image transitions to another image forms no part of the claimed design.

1 Claim, 9 Drawing Sheets

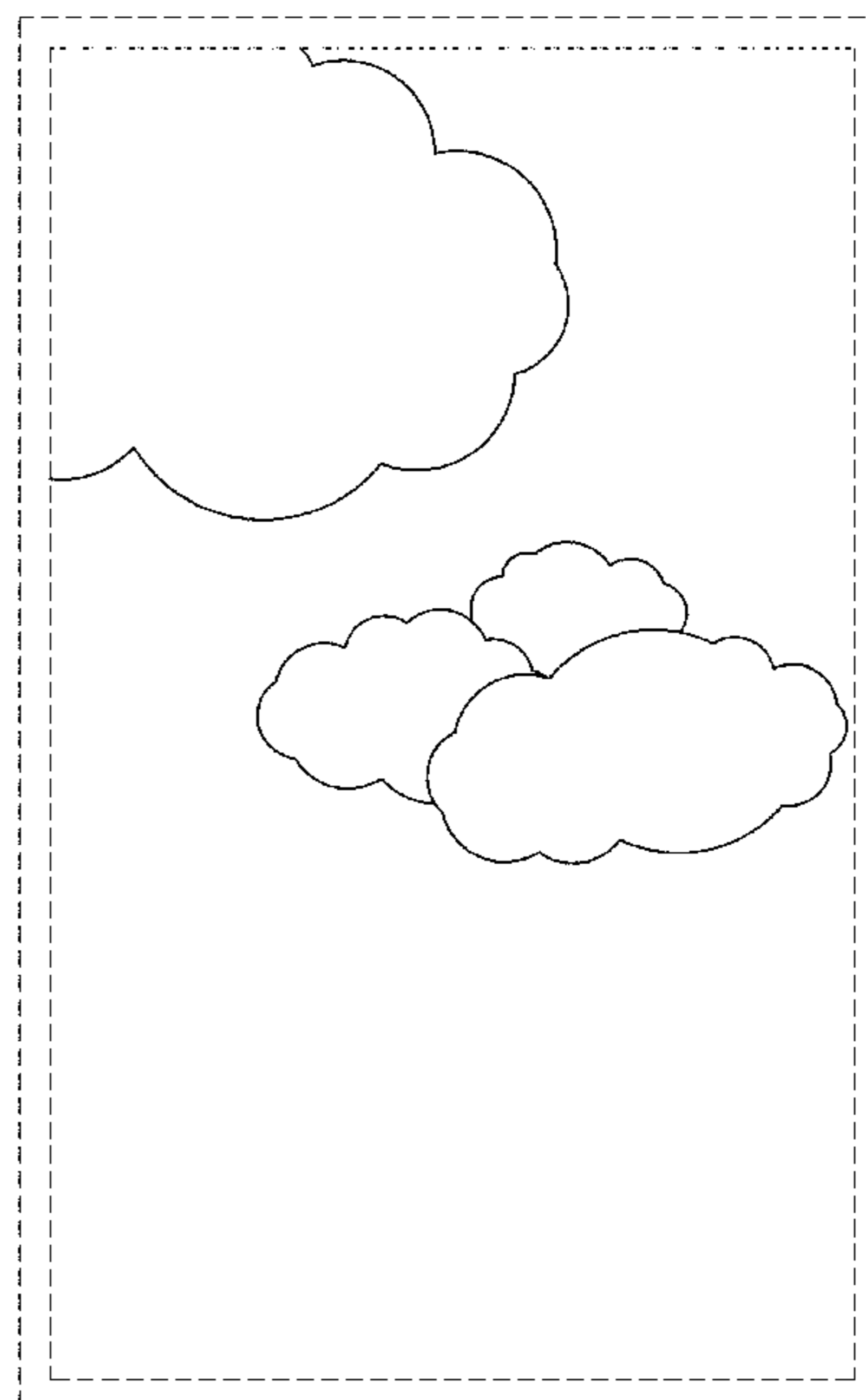
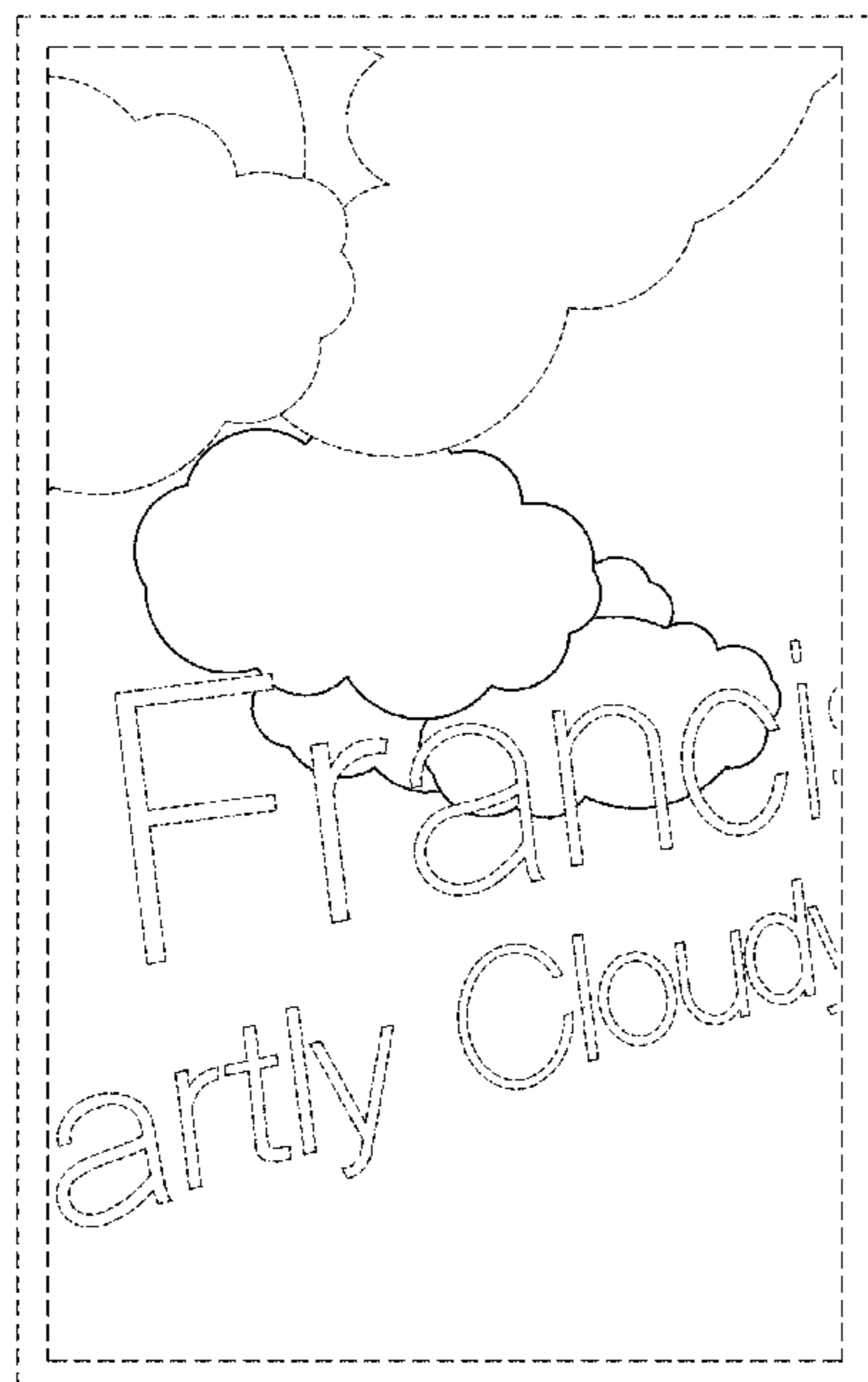

US D683,737 S

Page 2

U.S. PATENT DOCUMENTS

D648,731 S * 11/2011 Chou et al. D14/485
D648,732 S * 11/2011 Chou et al. D14/485
D648,733 S * 11/2011 Chou et al. D14/485
D652,049 S * 1/2012 Chou et al. D14/485
D672,366 S * 12/2012 Duggan et al. D14/492
2012/0150970 A1 * 6/2012 Peterson et al. 709/206

FOREIGN PATENT DOCUMENTS

EM 002107870-0002 * 9/2012
KR 300536866.0000 * 8/2009
WO D070873-001 * 12/2008
WO D070873-003 * 12/2008

* cited by examiner

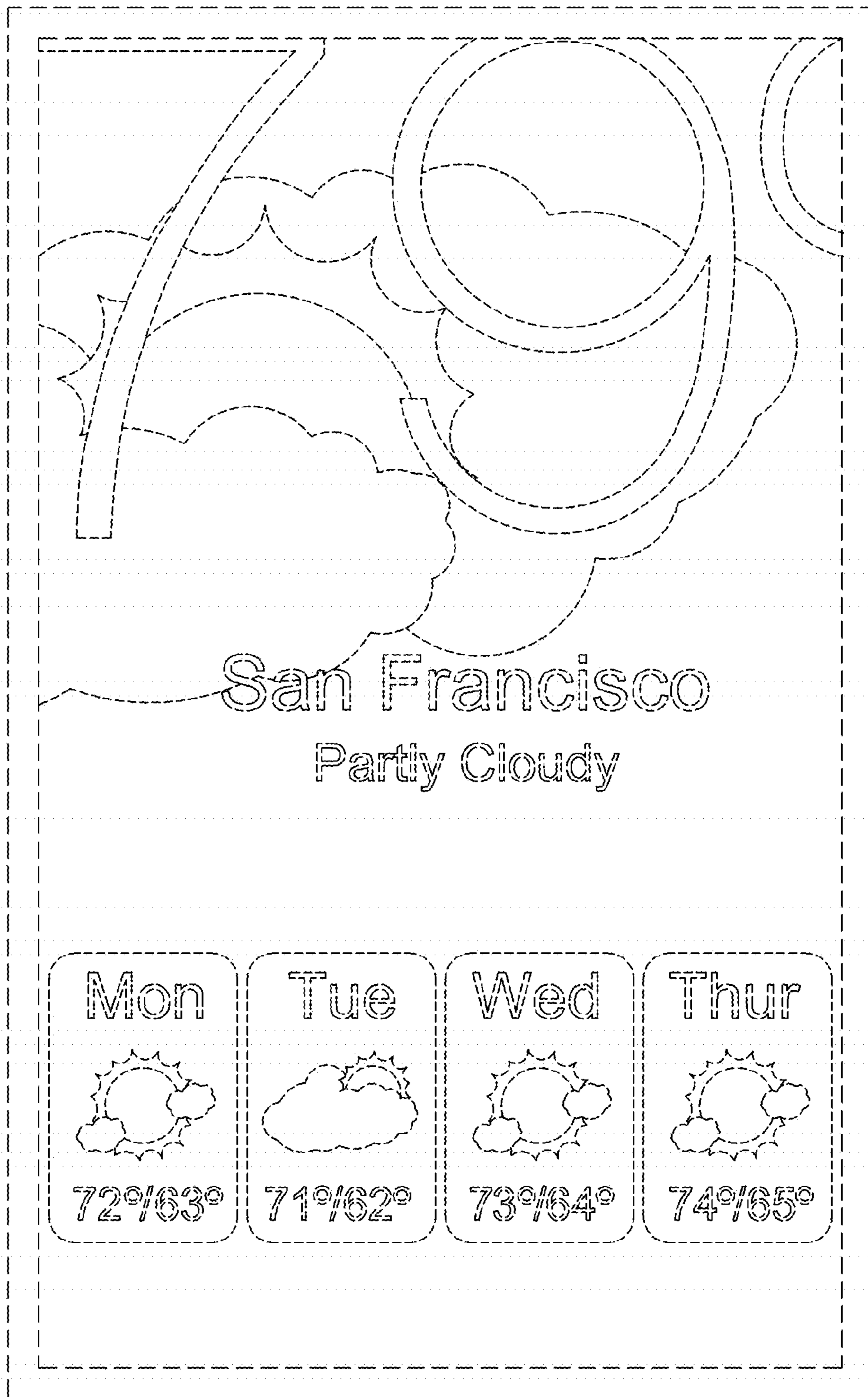

FIG. 1



FIG. 2



FIG. 3

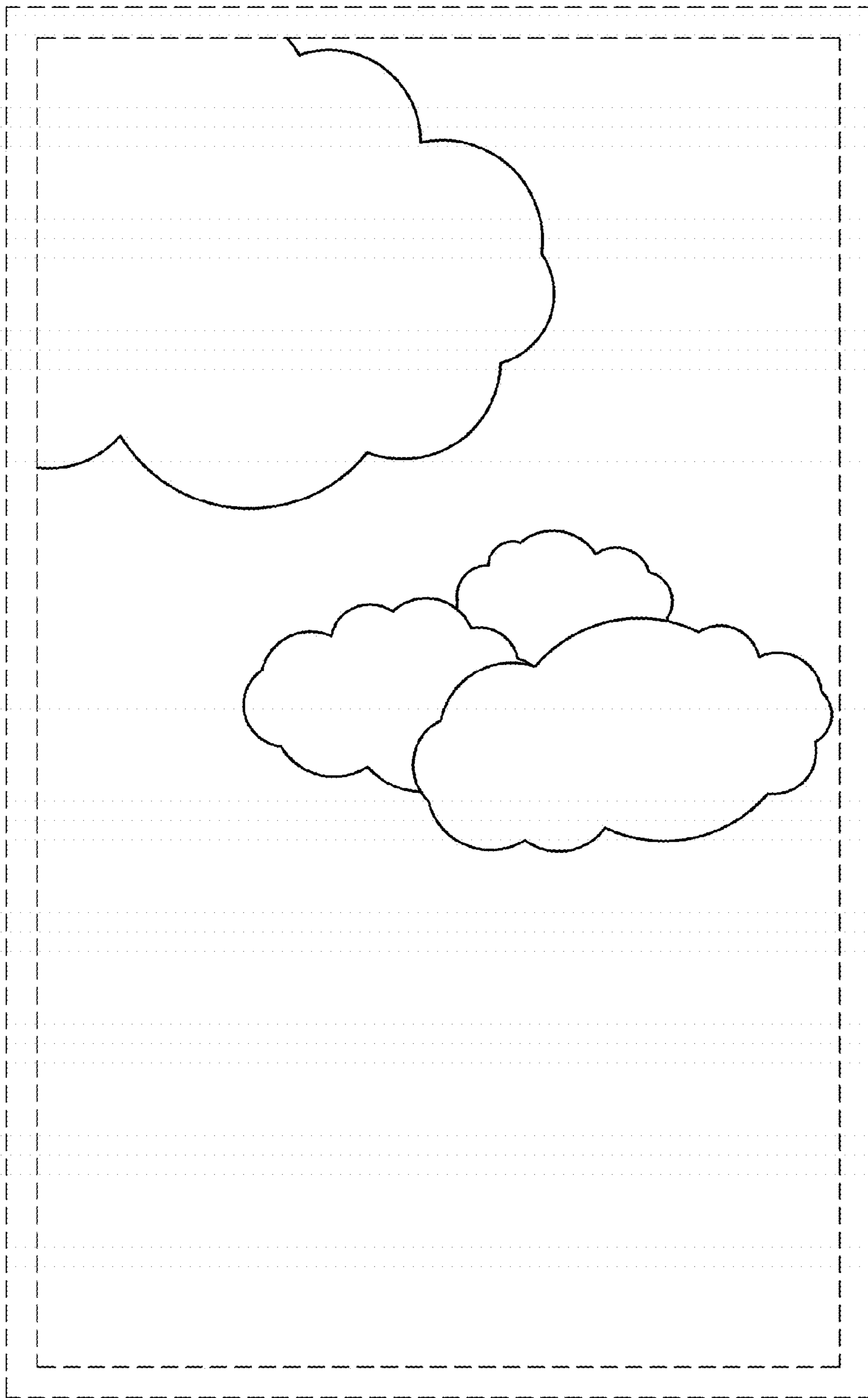

FIG. 4

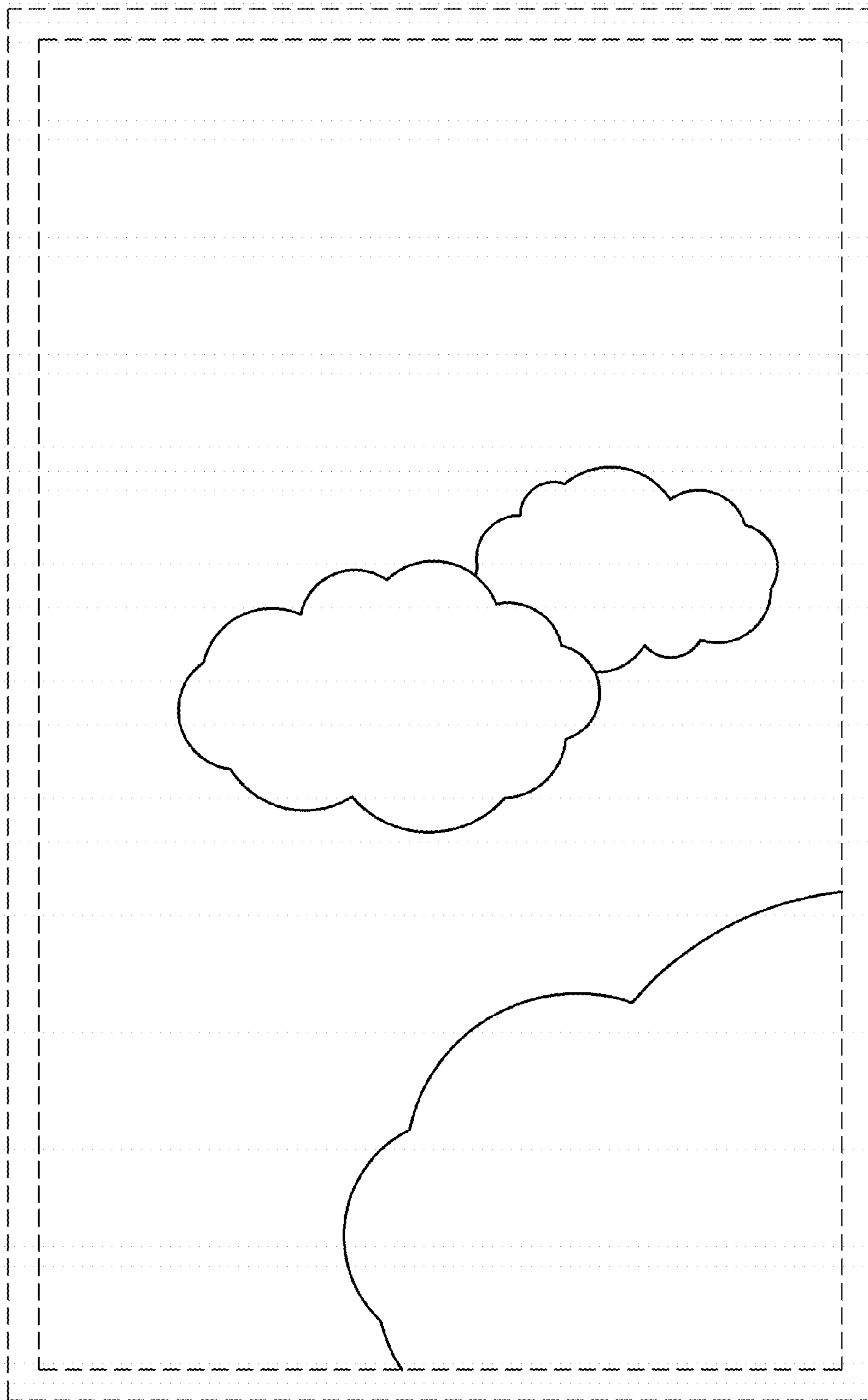

FIG. 5



FIG. 6

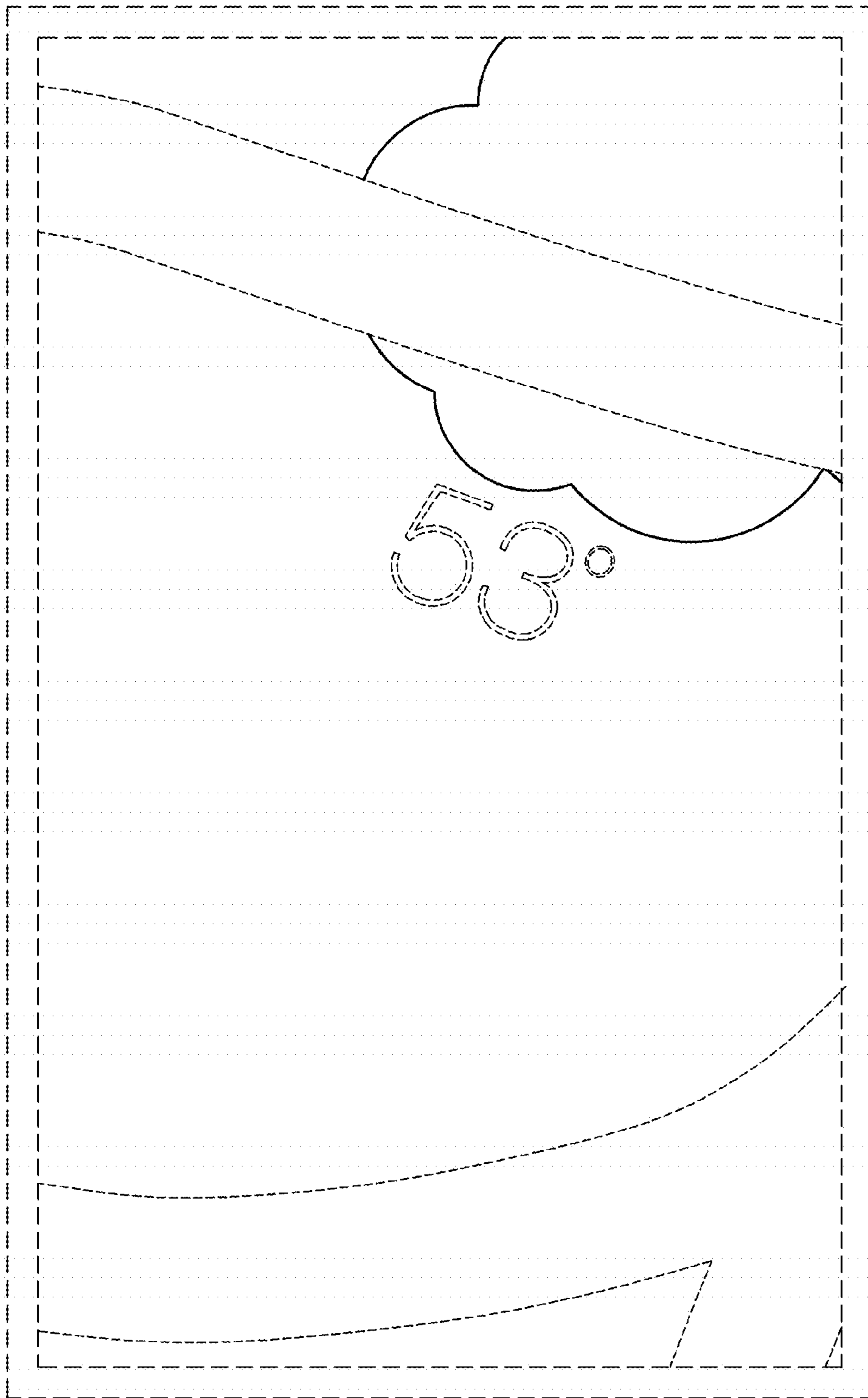

FIG. 7



FIG. 8

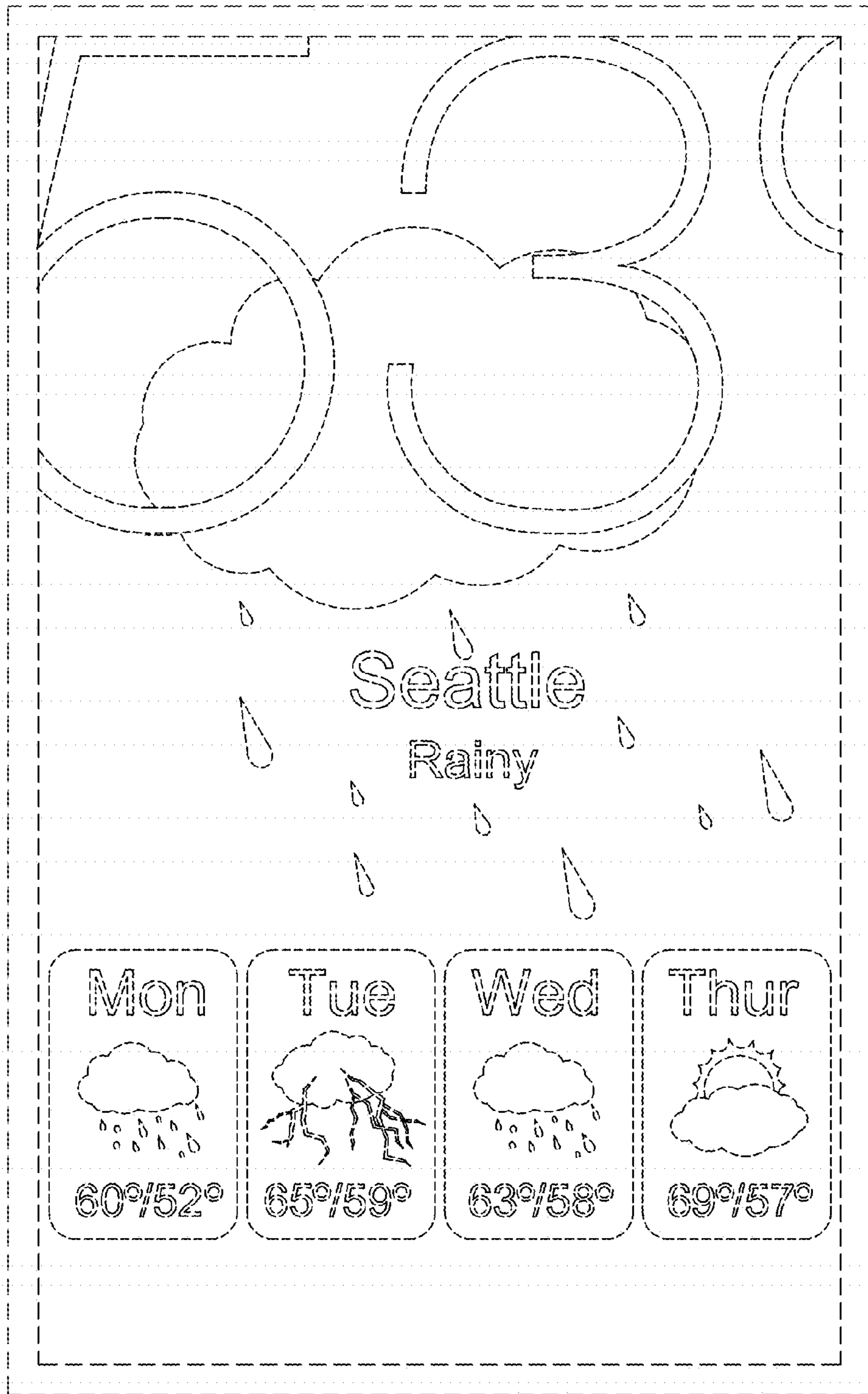

FIG. 9