



US00D683730S

(12) **United States Design Patent**  
**Akana et al.**

(10) **Patent No.:** **US D683,730 S**  
(45) **Date of Patent:** **\*\* Jun. 4, 2013**

(54) **PORTABLE DISPLAY DEVICE WITH GRAPHICAL USER INTERFACE**

D19/60; 345/169, 901, 905; 348/169; 361/814; 341/122; 346/173; 379/433.01, 433.07, 433.11, 379/433.12, 433.13, 910, 916, 433.06

(75) Inventors: **Jody Akana**, San Francisco, CA (US); **Bartley K. Andre**, Menlo Park, CA (US); **Daniel J. Coster**, San Francisco, CA (US); **Elizabeth Caroline Cranfill**, San Francisco, CA (US); **Daniele De Iuliis**, San Francisco, CA (US); **M. Evans Hankey**, San Francisco, CA (US); **Richard P. Howarth**, San Francisco, CA (US); **Mikio Inose**, Cupertino, CA (US); **Jonathan P. Ive**, San Francisco, CA (US); **Steve Jobs**, Palo Alto, CA (US); **Duncan Robert Kerr**, San Francisco, CA (US); **Stephen O. Lemay**, San Francisco, CA (US); **Shin Nishibori**, Portola Valley, CA (US); **Matthew Dean Rohrbach**, San Francisco, CA (US); **Peter Russell-Clarke**, San Francisco, CA (US); **Christopher J. Stringer**, Woodside, CA (US); **Eugene Antony Whang**, San Francisco, CA (US); **Rico Zorkendorfer**, San Francisco, CA (US)

See application file for complete search history.

(56) **References Cited**

U.S. PATENT DOCUMENTS

805,678 A 11/1905 Smith  
2,424,630 A 7/1947 Perez

(Continued)

FOREIGN PATENT DOCUMENTS

AU 315078 7/2007  
CA 72548 5/1993

(Continued)

OTHER PUBLICATIONS

<http://book-of-time-3d-screensaver.kryptile-screensavers.qarchive.org/>; Dec. 13, 2004; "Screenshot"; captured Apr. 20, 2011.\*  
Axiotron, Macworld Expo 2009 Wrap-Up, 4 pages, <http://www.axiotron.com/index.php?id=events>.\*

(Continued)

*Primary Examiner* — Barbara Fox

(74) *Attorney, Agent, or Firm* — Sterne, Kessler, Goldstein & Fox P.L.L.C.

(57) **CLAIM**

The ornamental design for a portable display device with graphical user interface, as shown and described.

**DESCRIPTION**

FIG. 1 is a front view of a portable display device with graphical user interface showing our new design;  
FIG. 2 is a rear view thereof;  
FIG. 3 is a top view thereof;  
FIG. 4 is a left side view thereof;  
FIG. 5 is a right side view thereof; and,  
FIG. 6 is a bottom view thereof.

The broken lines shown in the drawings represent unclaimed portions of the portable display device with graphical user interface and form no part of the claimed design.

**1 Claim, 3 Drawing Sheets**

(73) Assignee: **Apple Inc.**, Cupertino, CA (US)

(\*\*) Term: **14 Years**

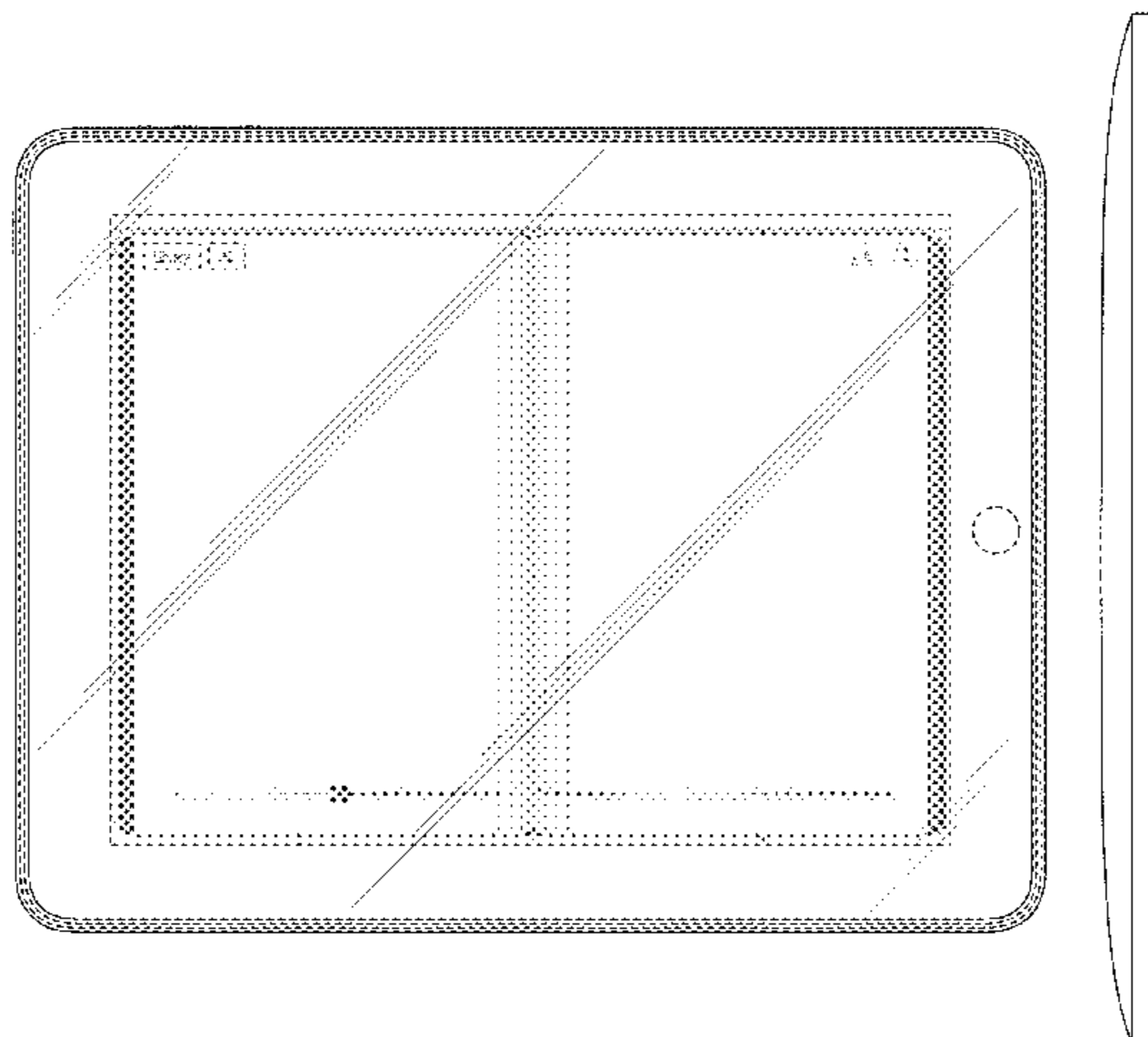
(21) Appl. No.: **29/365,379**

(22) Filed: **Jul. 8, 2010**

(51) **LOC (9) Cl.** ..... **14-02**

(52) **U.S. Cl.**  
USPC ..... **D14/341; D14/493**

(58) **Field of Classification Search**  
USPC ..... D14/341-347, 137, 138, 138.1, 138 AA, D14/138 R, 138 AB, 138 AC, 138 AD, 138 C, D14/138 G, 496, 203.1, 203.3, 203.4, 203.5, D14/203.6, 203.7, 426, 427, 428, 432, 429, D14/129, 130, 420, 439-441, 448, 125, 147, D14/156, 218, 247-248, 250, 389, 336, 485, D14/486, 493; D10/65, 104; D18/6-7; D21/29, D21/686, 33, 329, 330; D6/596, 601, 605;



# US D683,730 S

U.S. PATENT DOCUMENTS							
3,877,729	A	4/1975	Friedman	D466,096	S	11/2002	Takada
D262,151	S	12/1981	Sussman	D466,501	S	12/2002	Hirota
D265,326	S	7/1982	Sugiyama	D467,890	S	12/2002	Lai et al.
D270,061	S	8/1983	Ackeret	6,501,967	B1	12/2002	Mäkelä et al.
D270,062	S	8/1983	Ackeret	D469,413	S	1/2003	To et al.
D270,063	S	8/1983	Ackeret	6,509,907	B1	1/2003	Kuwabara
D270,066	S	8/1983	Ackeret	D469,762	S	2/2003	Iwama et al.
4,420,112	A	12/1983	Cline	D474,163	S	5/2003	Araki
D278,276	S	4/1985	Bakic	D480,721	S	10/2003	Hsieh
4,545,023	A	10/1985	Mizzi	D483,021	S	12/2003	Shih
D284,084	S	6/1986	Ferrara, Jr.	D483,032	S	12/2003	Bertrand et al.
4,610,392	A	9/1986	DaRosa	D483,037	S	12/2003	Whitehorn et al.
D289,873	S	5/1987	Gemmell et al.	D483,359	S	12/2003	Lin et al.
D306,583	S	3/1990	Krolopp et al.	D484,471	S	12/2003	Lin et al.
D308,055	S	5/1990	Tedham et al.	D485,265	S	1/2004	Sato et al.
D317,609	S	6/1991	Wei	D486,149	S	2/2004	Kawami et al.
D321,215	S	10/1991	Shamis	6,690,387	B2	2/2004	Zimmerman et al.
5,123,676	A	6/1992	Donnelly et al.	D488,469	S	4/2004	Batsikas
D332,328	S	1/1993	Lombardi, Jr.	D489,731	S	5/2004	Huang
D333,574	S	3/1993	Ackeret	D490,420	S	5/2004	Solomon et al.
D337,322	S	7/1993	Tso	D491,936	S	6/2004	Jao
D337,569	S	7/1993	Kando	D492,684	S	7/2004	Ozolins et al.
5,237,651	A	8/1993	Randall	D494,164	S	8/2004	Wu et al.
D340,701	S	10/1993	Takeuchi	6,773,195	B2	8/2004	Tims
D340,917	S	11/1993	Sakaguchi et al.	D496,040	S	9/2004	Jobs et al.
D345,346	S	3/1994	Alfonso et al.	D496,362	S	9/2004	Ozolins et al.
D346,589	S	5/1994	Andros	D496,363	S	9/2004	Ozolins et al.
D346,793	S	5/1994	Iino et al.	D497,364	S	10/2004	Ozolins et al.
5,345,543	A	9/1994	Capps et al.	D497,910	S	11/2004	Huang et al.
5,347,295	A	9/1994	Agulnick et al.	D498,763	S *	11/2004	Totten et al. .... D14/493
5,398,310	A	3/1995	Tchao et al.	6,822,635	B2	11/2004	Shahoian et al.
D361,552	S	8/1995	Iino	D500,037	S	12/2004	Ozolins et al.
5,463,725	A	10/1995	Henckel et al.	D502,179	S	2/2005	Cha et al.
D364,153	S	11/1995	Umaba et al.	D502,944	S	3/2005	Kawami et al.
5,488,204	A	1/1996	Mead et al.	D504,889	S	5/2005	Andre et al.
5,495,566	A	2/1996	Kwatinetz	D506,195	S	6/2005	Leveridge et al.
5,499,330	A	3/1996	Lucas et al.	6,924,822	B2	8/2005	Card et al.
D377,169	S	1/1997	Chida	6,989,815	B2	1/2006	Liang et al.
D384,050	S	9/1997	Kodosky	D514,558	S	2/2006	Nagel et al.
5,703,626	A	12/1997	Itoh et al.	D514,568	S	2/2006	Huang et al.
D395,639	S	6/1998	Ham et al.	D515,082	S	2/2006	Moskaluk et al.
D396,215	S	7/1998	Inukai	7,009,596	B2 *	3/2006	Seet et al. .... 345/156
D396,452	S	7/1998	Naruki	D526,661	S	8/2006	Arai
D398,299	S	9/1998	Ballay et al.	D528,517	S	9/2006	Izumi
D408,372	S	4/1999	Ota et al.	7,107,522	B1	9/2006	Morgan et al.
D408,794	S	4/1999	Ogasawara	D532,791	S	11/2006	Kim
D409,185	S	5/1999	Kawashima	D534,516	S	1/2007	Lheem
D410,440	S	6/1999	Carnell	D534,517	S	1/2007	Cho et al.
D412,157	S	7/1999	Stevenson	D535,281	S	1/2007	Yang
D415,136	S	10/1999	Newton et al.	D535,657	S	1/2007	Ording
D420,354	S	2/2000	Morales	7,171,630	B2	1/2007	O'Leary et al.
D422,582	S	4/2000	Bright et al.	D540,203	S	4/2007	Jeon
D422,583	S *	4/2000	Herceg et al. .... D14/493	D543,183	S	5/2007	Cho et al.
D424,535	S	5/2000	Peltola	D543,979	S	6/2007	Lee
D425,887	S	5/2000	Edwards et al.	D548,713	S	8/2007	Lee et al.
6,061,063	A	5/2000	Wagner et al.	D548,747	S	8/2007	Andre et al.
6,067,068	A	5/2000	Hussain	D555,663	S	11/2007	Nagata et al.
D438,201	S	2/2001	Ogawa et al.	D555,664	S	11/2007	Nagata et al.
6,217,443	B1	4/2001	Green, Jr.	D556,211	S	11/2007	Howard et al.
D444,465	S	7/2001	Do	D557,259	S	12/2007	Hirsch
D448,031	S	9/2001	Goetz	7,304,635	B2 *	12/2007	Seet et al. .... 345/156
D448,764	S	10/2001	Marsalka et al.	D558,756	S	1/2008	Andre et al.
6,297,824	B1	10/2001	Hearst et al.	D558,757	S	1/2008	Andre et al.
6,310,610	B1	10/2001	Beaton et al.	D558,758	S	1/2008	Andre et al.
D451,505	S	12/2001	Iseki et al.	D559,858	S *	1/2008	Gusmorino et al. .... D14/492
D452,687	S	1/2002	Yeh	D560,227	S	1/2008	Bennett et al.
D453,166	S	1/2002	Ording	D561,782	S	2/2008	Kim et al.
6,337,698	B1	1/2002	Keely, Jr. et al.	D563,424	S *	3/2008	Gusmorino et al. .... D14/492
D453,333	S	2/2002	Chen	D565,596	S	4/2008	Kim
D453,938	S	2/2002	Graham	D567,819	S	4/2008	Devericks et al.
D454,348	S	3/2002	Yeh	D568,309	S	5/2008	Cebe et al.
D455,433	S	4/2002	Alviar et al.	D568,892	S	5/2008	Stabb et al.
D456,023	S	4/2002	Andre et al.	D572,694	S	7/2008	Park
D456,805	S	5/2002	Ono et al.	D573,143	S	7/2008	Park et al.
D457,530	S	5/2002	Amron	D575,760	S	8/2008	Kim et al.
D458,252	S	6/2002	Palm et al.	D577,703	S	9/2008	Lee et al.
D461,175	S	8/2002	Yokota	7,437,005	B2	10/2008	Drucker et al.
D461,802	S	8/2002	Tu	D580,387	S	11/2008	Andre et al.
				D580,431	S	11/2008	Morita

# US D683,730 S

D581,922 S	12/2008	Andre et al.		D635,952 S	4/2011	Park et al.	
D583,346 S	12/2008	Jung et al.		D635,989 S *	4/2011	Bright et al. ....	D14/493
D583,373 S	12/2008	Chen		D636,390 S	4/2011	Andre et al.	
D584,711 S	1/2009	Kim et al.		D637,596 S	5/2011	Akana et al.	
D584,738 S	1/2009	Kim et al.		D638,027 S	5/2011	Towbin et al.	
D586,800 S	2/2009	Andre et al.		D638,439 S	5/2011	Cavanaugh et al.	
D592,211 S	5/2009	Ichise et al.		D638,835 S	5/2011	Akana et al.	
D592,212 S	5/2009	Hamada et al.		D647,911 S	11/2011	Allen et al.	
D593,059 S	5/2009	Kim et al.		2003/0117425 A1	6/2003	O'Leary et al.	
D593,132 S	5/2009	Kim		2003/0125079 A1	7/2003	Park et al.	
7,536,654 B2	5/2009	Anthony et al.		2003/0125094 A1	7/2003	Hyun et al.	
D594,863 S	6/2009	Ichise et al.		2003/0125959 A1	7/2003	Palmquist	
D597,067 S	7/2009	Oh et al.		2003/0184525 A1	10/2003	Tsai	
D598,016 S	8/2009	Han et al.		2003/0206202 A1	11/2003	Moriya	
7,581,186 B2	8/2009	Dowdy et al.		2003/0210949 A1	11/2003	Tims	
D599,342 S	9/2009	Andre et al.		2004/0021676 A1	2/2004	Chen et al.	
D600,241 S	9/2009	Andre et al.		2004/0039750 A1	2/2004	Anderson et al.	
D600,690 S	9/2009	Miyaji		2004/0041504 A1	3/2004	Ozolins et al.	
D601,170 S *	9/2009	Pell et al. ....	D14/493	2004/0145603 A1	7/2004	Soares	
D601,353 S	10/2009	Sadler et al.		2004/0255254 A1	12/2004	Weingart et al.	
D601,558 S	10/2009	Andre et al.		2005/0144565 A1	6/2005	Hemmings	
D602,014 S	10/2009	Andre et al.		2005/0156902 A1	7/2005	McPherson et al.	
D602,015 S	10/2009	Andre et al.		2006/0066510 A1	3/2006	Takahashi	
D602,016 S	10/2009	Andre et al.		2007/0168883 A1	7/2007	Sugimoto	
D602,017 S	10/2009	Andre et al.		2008/0004083 A1	1/2008	Ohki et al.	
D602,486 S	10/2009	Andre et al.		2009/0247244 A1	10/2009	Mittleman et al.	
D602,488 S	10/2009	Jiang et al.		2011/0167369 A1	7/2011	van Os	
D604,289 S	11/2009	Andre et al.					
D604,290 S	11/2009	Andre et al.					
D604,291 S	11/2009	Andre et al.					
D604,292 S	11/2009	Andre et al.					
D604,293 S	11/2009	Andre et al.					
D604,297 S	11/2009	Andre et al.					
D604,733 S	11/2009	Andre et al.					
D606,129 S	12/2009	Ben-Moshe					
D606,988 S	12/2009	Andre et al.					
D606,989 S	12/2009	Andre et al.					
D606,991 S	12/2009	Liu et al.					
D606,992 S	12/2009	Liu et al.					
D607,428 S	1/2010	Kim et al.					
D607,889 S *	1/2010	Poling et al. ....	D14/485				
D609,705 S	2/2010	Andre et al.					
D609,715 S	2/2010	Chaudhri					
D610,161 S	2/2010	Matas					
7,658,675 B2	2/2010	Hotta					
D611,045 S	3/2010	Andre et al.					
D611,469 S	3/2010	Andre et al.					
7,688,574 B2	3/2010	Zadesky et al.					
D613,300 S	4/2010	Chaudhri					
D613,735 S	4/2010	Andre et al.					
D613,736 S	4/2010	Andre et al.					
D615,083 S	5/2010	Andre et al.					
D615,554 S	5/2010	Andre et al.					
D620,004 S	7/2010	Andre et al.					
D621,825 S	8/2010	Andre et al.					
D622,718 S	8/2010	Andre et al.					
D622,719 S	8/2010	Andre et al.					
D622,720 S	8/2010	Andre et al.					
D624,072 S	9/2010	Andre et al.					
D624,536 S	9/2010	Andre et al.					
D624,914 S	10/2010	Wang					
D624,935 S *	10/2010	Umezawa ....	D14/493				
D625,307 S	10/2010	Cheng					
D625,326 S	10/2010	Allen					
D627,343 S	11/2010	Andre et al.					
D627,777 S	11/2010	Akana et al.					
D627,778 S	11/2010	Akana et al.					
D629,010 S *	12/2010	O'Donnell et al. ....	D14/492				
D629,413 S *	12/2010	Sriver ....	D14/486				
D629,799 S	12/2010	Andre et al.					
D630,207 S	1/2011	Seong					
D630,630 S	1/2011	Andre et al.					
D633,523 S *	3/2011	Trabona et al. ....	D14/493				
D633,908 S	3/2011	Akana et al.					
D633,917 S *	3/2011	Poling et al. ....	D14/485				
D634,319 S	3/2011	Andre et al.					
D634,742 S	3/2011	Andre et al.					
7,898,541 B2	3/2011	Hong et al.					
D635,540 S	4/2011	Kim et al.					

## FOREIGN PATENT DOCUMENTS

CA	89155	3/2000
CA	101263	1/2004
CN	200430011774.1	6/2005
CN	1695105 A	11/2005
CN	200630030574.X	8/2007
CN	200630174414.2	12/2007
CN	200730008464.8	3/2008
CN	200730058820.7	6/2008
CN	200930166104.X	2/2010
CN	200930166516.3	5/2010
CN	200930166757.8	6/2010
CN	301499241 S	3/2011
DE	40104198-0001	9/2001
DE	40301867-0001	9/2003
DE	40705936-0001	5/2008
EM	00048061-0001	8/2003
EM	00046198-0001	11/2003
EM	000181607-0001	8/2004
EM	000317490-0001	5/2005
EM	000328265-0001	6/2005
EM	000257621-0004	7/2005
EM	000375191-0001	9/2005
EM	000401898-0003	11/2005
EM	000493721-0002	5/2006
EM	000569157-0005	9/2006
EM	000614565-0001	12/2006
EM	30-0441230	2/2007
EM	00066789-0001	3/2007
EM	000718770-0007	6/2007
EM	000748280-0001	8/2007
EM	000748280-0006	8/2007
EM	000767959-0001	8/2007
EM	000748314-0001	10/2007
EM	000891809-0003	4/2008
EM	000939731-0001	6/2008
EM	001005839-0007	3/2009
EM	001098149-0001	4/2009
EM	001098149-0005	4/2009
EM	001143010-0005	7/2009
EM	001594771-0004	7/2009
EM	001677816-0002	4/2010
EM	001694712-0001	4/2010
EM	001214290-0003	6/2010
EM	001222905-0001	10/2010
EM	001222905-0002	10/2010
EM	001772252-0001	10/2010
EM	001000152-0001	11/2010
EM	001140115-0001	11/2010
EP	0 701 220 B1	7/2001
ES	I0147763	3/2001

# US D683,730 S

Page 4

ES	D0505712-01	4/2008	KR	30-0304213	8/2002
FI	4897	7/1980	KR	30-0307008	9/2002
FR	990052-001	5/1999	KR	30-0307235	9/2002
FR	985598-001	10/2001	KR	30-0307307	9/2002
FR	985598-002	10/2001	KR	30-0309692	10/2002
FR	985598-003	10/2001	KR	30-0312151	11/2002
FR	985598-004	10/2001	KR	30-0312152	11/2002
GB	1042780	12/1986	KR	30-0327126	6/2003
GB	1058720	10/1988	KR	30-0330831	8/2003
GB	1058721	10/1988	KR	30-0332851	9/2003
GB	2030050	10/1992	KR	30-0336260	10/2003
GB	2033245	8/1993	KR	30-0338781	11/2003
GB	2101448	10/2000	KR	2003-0088374	11/2003
GB	2103809	2/2001	KR	30-0338886	12/2003
GB	3009998	1/2003	KR	30-0326632-2	1/2004
GB	3010002	1/2003	KR	30-0398307	11/2005
GB	3014024	8/2003	KR	30-0394921-1	12/2005
GB	3022447	10/2005	KR	30-0418422-1	7/2006
JP	61-69284	4/1986	KR	30-0418547	7/2006
JP	4-370868	12/1992	KR	30-0422221	8/2006
JP	886431	12/1993	KR	30-0422222	8/2006
JP	887388	12/1993	KR	30-0424148	9/2006
JP	6-102341	4/1994	KR	30-0452432	6/2007
JP	000921403	3/1995	KR	30-0452985	8/2007
JP	949744	3/1996	KR	30-0529167	5/2009
JP	953136	5/1996	KR	30-0533504	7/2009
JP	9-325180	12/1997	KR	30-0546031	11/2009
JP	001009317	5/1998	KR	30-0598018	5/2011
JP	11-112918	4/1999	KR	30-0598021	5/2011
JP	11-126149	5/1999	SE	55044	10/1993
JP	11-189269	10/1999	SE	2001/0343	9/2002
JP	1056385	12/1999	TW	584453	4/2004
JP	2000-163031	6/2000	TW	D106137	8/2005
JP	2000-322495	11/2000	TW	D137754	11/2010
JP	2001-22471	1/2001	WO	WO 00/74240 A1	12/2000
JP	2001-22704	1/2001	WO	WO 01/88679	11/2001
JP	D1098145	1/2001	WO	WO 2004/023272 A2	3/2004
JP	001104685	3/2001			
JP	D1124750	10/2001			
JP	D1133939	2/2002			
JP	001142127	5/2002			
JP	D1143615	6/2002			
JP	D1145748	7/2002			
JP	2002-254614	9/2002			
JP	D1155168	10/2002			
JP	D1155176	10/2002			
JP	D1159881	12/2002			
JP	D1178470	7/2003			
JP	001188041	10/2003			
JP	2003-330613	11/2003			
JP	D1194485	1/2004			
JP	D1204221	5/2004			
JP	2004-290256	10/2004			
JP	001235888	4/2005			
JP	001241638	6/2005			
JP	D1241383	6/2005			
JP	D1247215	8/2005			
JP	D1250487	9/2005			
JP	D1263649	2/2006			
JP	001280315	9/2006			
JP	D1285057	10/2006			
JP	D1295003	2/2007			
JP	D1302929	6/2007			
JP	D1325539	3/2008			
JP	D1351273	2/2009			
KR	30-0037851	8/1982			
KR	30-0109896	11/1990			
KR	30-0110034	11/1990			
KR	30-0213519	4/1998			
KR	30-0222985-1	2/1999			
KR	30-0327641	6/1999			
KR	30-0241312	7/1999			
KR	30-0243584	8/1999			
KR	30-0288858	1/2002			
KR	30-0290725	1/2002			
KR	30-0291915	2/2002			
KR	30-0294002	3/2002			
KR	30-0296928	5/2002			
KR	30-0297741	5/2002			

## OTHER PUBLICATIONS

U.S. Appl. No. 29/350,879, Imran Chaudhri, "Animated Graphical User Interface for a Display Screen or Portion Thereof", filed Nov. 24, 2009.

U.S. Appl. No. 29/354,599, Akana et al., "Portable Display Device", filed Jan. 26, 2010.

U.S. Appl. No. 29/365,378, Akana et al., "Portable Display Device with Graphical User Interface", filed Jul. 8, 2010.

U.S. Appl. No. 29/365,381, Akana et al., "Portable Display Device with Graphical User Interface", filed Jul. 8, 2010.

U.S. Appl. No. 29/365,383, Akana et al., "Portable Display Device with Graphical User Interface", filed Jul. 8, 2010.

U.S. Appl. No. 29/365,385, Anzures et al., "Portable Display Device with Graphical User Interface", filed Jul. 8, 2010.

U.S. Appl. No. 29/366,479, Cranfill et al., "Animated Images for a Display Screen or Portion Thereof", filed Jul. 26, 2010.

U.S. Appl. No. 29/382,846, "Portable Display Device", filed Jan. 7, 2011.

U.S. Appl. No. 29/384,911, "Portable Display Device", filed Feb. 4, 2011.

U.S. Appl. No. 29/384,918, "Portable Display Device with Graphical User Interface", filed Feb. 4, 2011.

U.S. Appl. No. 29/389,638, Akana et al., "Portable Display Device", filed Apr. 14, 2011.

Arrington, Michael, CrunchPad: The Launch Prototype, 17 pages, <http://techcrunch.com/2009/06/03/crunchpad-the-launch-prototype/>, Jun. 3, 2009.

Arrington, Michael, TechCrunch Tablet Update: Prototype B, 25 pages, <http://techcrunch.com/2009/01/19/techcrunch-tablet-update-prototype-b/>, Jan. 19, 2009.

Chubb, Daniel, Amtek's iTablet T221: new to the tabley and UMPC scene, 4 pages, <http://www.product-reviews.net/2008/01/11/amteks-itablt-t221-new-to-the-tablet-and-umpc-scene/>, Jan. 11, 2008.

Coldeway, Devin, TechCrunch Tablet makes an early debut, 26 pages, <http://www.crunchgear.com/2009/04/09/crunchtablet-hits-the-net-a-little-early/>, Apr. 9, 2009.

- Davies, Chris, Are Dell planning a keyboard-less UMPC?, 15 pages, <http://www.slashgear.com/are-dell-planning-a-keyboard-less-umpc-096130/>, Jul. 9, 2007.
- Dunn, Jason, Ultra-Portable Concept PC Shown at WinHEC 2005, 1 page, <http://www.digitalthomethoughts.com/news/show/27459/ultra-portable-concept-pc-shown-at-winhec-2005.html>, Apr. 26, 2005.
- Lerg, Andreas, Billig-Tablet-Computer vom Grabbeltisch, 2 pages, [http://digitalleben.t-online.de/tablet-pc-von-jay-tech-fuer-140-euro-bei-rossmann/id\\_43326132/index](http://digitalleben.t-online.de/tablet-pc-von-jay-tech-fuer-140-euro-bei-rossmann/id_43326132/index), Nov. 3, 2010.
- Layola, Roman, Macworld Video: Axiotron Modbook Pro first look, 4 pages, <http://www.macworld.com/article/137878/2009/01/mwvodcast86.html>, Jan. 5-9, 2009.
- Newgadgets.de, Mysteriöser Tablet-PC?, 6 pages, <http://www.newgadgets.de/6072/mysterioser-tablet-pc/>, Nov. 10, 2009.
- Radioshack, Motorola DEFY with MOTOBUR Black, 1 page, [http://radioshackwireless.com/eCommerce/SpecialOffer.aspx?cid=25578\\_47f08265355e4a8a92dcd57eed6cbc69](http://radioshackwireless.com/eCommerce/SpecialOffer.aspx?cid=25578_47f08265355e4a8a92dcd57eed6cbc69).
- Receipt of an Invalidity Application Notification to the Holder of the Contested RCD, Community Design No. 001222905-0002, File No. ICD 8453, 1 page, mailed May 23, 2011.
- Sierra, Amtek Releases the iTablet T221 Tablet PC, Laptops Arena, 5 pages, <http://www.laptopsarena.com/amtek-releases-the-itablt-t221-tablet-pc/>, Dec. 22, 2007.
- Sze, Amtek has five iTablets for the Computex 2010, iTech News Net, 13 pages, <http://www.itechnews.net/2010/05/27/amtek-has-five-itablt-for-the-computex-2010/>.
- Topolsky, Joshua, Amtek intros the iTablet T221 UMPC, 3 pages, <http://www.engadget.com/2007/12/18/amtek-intros-the-itablt-t221-umpc/>, Dec. 18, 2007.
- Wikipedia, Axiotron Modbook, 4 pages, [http://en.wikipedia.org/wiki/Axiotron\\_Modbook](http://en.wikipedia.org/wiki/Axiotron_Modbook).
- Wikipedia, Datei:Modbook pro.jpg, 4 pages, [http://de.wikipedia.org/wiki/Datei:Modbook\\_pro.jpg](http://de.wikipedia.org/wiki/Datei:Modbook_pro.jpg), Feb. 21, 2009.
- Wikipedia, Datei:VIA Tablet PC Reference Design.jpg, 3 pages, [http://de.wikipedia.org/wiki/Datei:VIA\\_Tablet\\_PC\\_Reference\\_Design.jpg](http://de.wikipedia.org/wiki/Datei:VIA_Tablet_PC_Reference_Design.jpg), Mar. 10, 2009.
- Wikipedia, Dynabook, 2 pages, <http://de.wikipedia.org/wiki/Dynabook>, last updated Apr. 2, 2011.
- Wikipedia, Tablet-Computer, 3 pages, <http://de.wikipedia.org/wiki/Tablet-Computer>, Apr. 7, 2011.
- Wikipedia, Tablet-PC, 2 pages, <http://de.wikipedia.org/wiki/Tablet-PC>, Apr. 14, 2011.
- Request for declaration of invalidity of design No. 001222905-0002, 7 pages, May 5, 2011.
- Search Report for ROC (Taiwan) Design Patent Application No. 099303076, completed May 25, 2011, 1 page.
- Search Report for ROC (Taiwan) Design Patent Application No. 099303077, completed May 25, 2011, 1 page.
- HP Compaq Tablet PC TC1000-TM5800 1GHz-10.4" TFT, CNET Reviews, [http://reviews.cnet.com/tablet-pcs/hp-compaq-tablet-pc/4505-1707\\_7-20627295.html](http://reviews.cnet.com/tablet-pcs/hp-compaq-tablet-pc/4505-1707_7-20627295.html). Download Apr. 20, 2010, 15 pages.
- HP Compaq Tablet PC TC1000, <http://www.tc-one-thousand.com>. Downloaded Apr. 20, 2010, 2 pages.
- HP Compaq Tablet PC TC1000, <http://www.hardwarezone.com.au/reviews/view.php?cid=45&id=533&pg=2>. Downloaded Apr. 20, 2010, 1 page.
- Bookeen—Cybook ePaper—the eBook reading device, <http://www.bookeen.com/ebook/ebook-reading-device.aspx>. Downloaded Apr. 26, 2010, 2 pages.
- BeBook Neo e-reader launches with WiFi and WACOM capabilities—Engadget, <http://www.engadget.com/2010/01/22/bebook-neo-e-reader-launches-with-wifi-and-wacom-capabilities/>. Downloaded Apr. 26, 2010, 2 pages.
- CES: Plastic Logic's Que E-Reader Revealed—PCWorld, [http://www.pcworld.com/article/186224/ces\\_plastic\\_logics\\_que\\_ereader\\_revealed.html](http://www.pcworld.com/article/186224/ces_plastic_logics_que_ereader_revealed.html). Downloaded Apr. 26, 2010, 1 page.
- The Best of CES 2010, [http://www.pcworld.com/article/186511/another\\_excellent\\_ereader.html](http://www.pcworld.com/article/186511/another_excellent_ereader.html). Downloaded Apr. 26, 2010, 1 page.
- iRex Digital Reader 800 with 8-inch touchscreen and wireless | Gadget Folder, <http://www.gadgetfolder.com/irex-digital-reader-800-with-8-inch-touchs...> Downloaded Jun. 29, 2010, 3 pages.
- Amazon, “Developing Tablet PC Applications—(Charles River Media Programming),” (<http://www.amazon.com.uk/Developing-Tablet-Applications-Charles-Programming/dp/1584502525>), retrieved Jul. 20, 2011, 4 pages.
- Association for Computing Machinery, The Open Video Project, “ACM CHI 1995—The Tablet Newspaper: A vision for the Future,” (<http://www.open-video.org/details.php?videoid=8315&surrogate=storyboard>), 3 pages (1994).
- Aumente, J., American Journalism Review, “Panel Vision,” (<http://www.ajr.org/Article.asp?id=1257>), published Oct. 1994, 7 pages.
- Blickstorfer, C., PenComputing Magazine, “Tablet PCs: HP Compaq Tablet PC TC1000,” ([http://www.pencomputing.com/frames/tpc\\_compaq.html](http://www.pencomputing.com/frames/tpc_compaq.html)), 3 pages (Dec. 2002).
- Blickstorfer, C., PenComputing Magazine, “Tablet PCs: Motion Computing M1200,” ([http://www.pencomputing.com/frames/tpc\\_motion1200.html](http://www.pencomputing.com/frames/tpc_motion1200.html)), 3 pages (Dec. 2002).
- Blickstorfer, C., PenComputing Magazine, “Tablet PCs: ViewSonic V1100,” ([http://www.pencomputing.com/frames/tps\\_viewsonic.html](http://www.pencomputing.com/frames/tps_viewsonic.html)), 3 pages (Dec. 2002).
- Chi-atheneum, “Good Design 2003, An International Industrial and Graphic Design Competition,” (<http://www.chi-atheneum.org/gdesign/winners03.htm>), retrieved Sep. 23, 2011, 7 pages.
- Cnet, “HP Compaq tablet PC TC1000 Review,” [http://reviews.cnet.com/tablet-pcs/hp-compaq-tablet-pc/4505-3126\\_7-20627295.html](http://reviews.cnet.com/tablet-pcs/hp-compaq-tablet-pc/4505-3126_7-20627295.html), published Nov. 6, 2002, 8 pages.
- Computing History, “GRidPad 1910,” (<http://computinghistory.org/uk/det/6565/GRidPad-1910>), retrieved Sep. 12, 2011, 2 pages.
- Digibarn Computer Museum, “PenPoint tablet pen computer by GO Corporation,” (<http://www.digibarn.com/collections/systems/go/index.html>), retrieved Jul. 18, 2011, 6 pages.
- DigiBarn Systems, “GRidPad Pen Computing,” (<http://www.digibarn.com/collections/systems/gridpad/index.html>), retrieved Sep. 23, 2011, 2 pages.
- Edible Tablet, “The first Apple Tablet . . . from 1979,” (<http://www.edibleapple.com/the-first-apple-tablet-from-1979/>), published Nov. 23, 2009, 8 pages.
- Electronista, “LG/Prada phone revealed?,” (<http://www.electronista.com/articles/06/12/20/lg.prada.phone.revealed/>), updated Dec. 12, 2006, 9 pages.
- Electrovaya, “Electrovaya Launches Scribbler® SC4000 Series Tablet PC,” published Jan. 9, 2008, 2 pages.
- EngineerBoy, CleverDonkey.com, “2001: A Space Odyssey and the iPad (or is it tamPod?),” (<http://www.cleverdonkey.com/1499-2001a-space-odyssey-and-the-ipad-or-is-it-tampod/>), published Feb. 2, 2010, 5 pages.
- Gizmodo, “Kurztest: JooJoo (Crunchpad)—riesiges Internet-Tablet,” (<http://www.gizmodo.de/2009/12/09/kurztest-joojoo-crunchpad-resiges-internet-tablet.html>), retrieved Sep. 26, 2011, 13 pages.
- Hagen, R., GadgetZone, “iHolic portable Mediaspeler,” (<http://www.gadgetzone.nl/nieuws.php?od=3191>), published Jan. 4, 2007, 3 pages.
- Jarrett, R. et al., Building Tablet PC Applications, pp. 38, Microsoft Press, Redmond, Washington, (2003).
- Kahney, L., Wired, “Apple’s Newton Just Won’t Drop,” (<http://www.wired.com/gadgets/mac/commentary/cultofmac/2002/08/54580>), published Aug. 29, 2002, 2 pages.
- Martin, T., “The Tablet Newspaper: A vision for the Future,” Human Factors in Computing Systems, Chi ’95 Conference Companion, pp. 425, Colorado, United States (May 1995).
- NewLaunches, “LG Prada cell phones are truly iconic,” ([http://www.newlaunches.com/archives/lg\\_prada\\_cell\\_phones\\_are\\_truly\\_iconic.php](http://www.newlaunches.com/archives/lg_prada_cell_phones_are_truly_iconic.php)), retrieved Sep. 12, 2011, 3 pages.
- NewLaunches, “LG Wears Prada,” ([http://www.newlaunches.com/archives/lg\\_wears\\_prada.php](http://www.newlaunches.com/archives/lg_wears_prada.php)), retrieved Sep. 23, 2011, 2 pages.
- NotebookCheck, “Fujitsu-Siemens Stylistic ST5022,” (<http://www.notebookcheck.com/typo3temp/pics/d675d29c1f.jpg>), retrieved Sep. 26, 2011, 1 page.
- PC Magazine, “HP Compaq Tablet PC TC1000,” (<http://www.pcmag.com/article/0,2817%20,939500,00.asp>), published Apr. 8, 2003, 3 pages.

- Samsung, "Samsung F700 razendsnelle alleskunner voor mobiel breedband van Vodafone," ([http://www.samsung.com/nl/mobile/pressView.do?ptype=press&page=13&news\\_seq=22544](http://www.samsung.com/nl/mobile/pressView.do?ptype=press&page=13&news_seq=22544)), published May 25, 2008, 2 pages.
- Samsung, "SAMSUNG Unveils Revolutionary Ultra Smart F700," ([http://www.samsung.com/us/news/newsRead.do?news\\_seq=3516](http://www.samsung.com/us/news/newsRead.do?news_seq=3516)), published Nov. 23, 2009, 2 pages.
- Smith, C., HuffPost Tech, "History of Tablet PCs (PHOTOS): A Pictorial Timeline Of Tablets, From RAND To The iPad," ([http://www.huffingtonpost.com/2010/04/15/history-tablet-pc-photos\\_n\\_538806.html](http://www.huffingtonpost.com/2010/04/15/history-tablet-pc-photos_n_538806.html)), published Apr. 15, 2010, 5 pages.
- Tan, K., Shanghaiist, "ZOMG! Maker of Chinese iPad clone P88 to sue Apple for cloning its tablet!," (<http://shanghaiist.com/2010/29/p88-chinese-ipad-clone-sues-apple.php>), published Jan. 29, 2010, 5 pages.
- Van Reeth, J., "Vantage is showing its colours!," *Home automation journal* 11:1-8, Vantage Ema, Belgium (Jun. 2003).
- Wikipedia, "Etch A Sketch," ([http://en.wikipedia.org/wiki/Etch\\_a\\_sketch](http://en.wikipedia.org/wiki/Etch_a_sketch)), last modified Aug. 24, 2011, 2 pages.
- Wikipedia, "MessagePad," (<http://en.wikipedia.org/wiki/Messagepad>), retrieved Sep. 12, 2011, 10 pages.
- ZDNet, "Viewsonic V1100," (<http://www.zdnet.nl/reviews/24712/viewsonic-v1100/>), published Feb. 17, 2003, 9 pages.
- Ziegler, C., Engadget, "The LG KE850: touchable chocolate," (<http://mobile.engadget.com/2006/12/15/the-lg-ke850-touchable-chocolate/>), published Dec. 15, 2006, 5 pages.
- Search Report for ROC (Taiwan) Design Patent Application No. 099303075 (English Translation), completed Jan. 21, 2011.
- Request for Re-examination of Australian Design Registration Nos. 337931, 337833, 337832, filed Sep. 13, 2011, 3 pages.
- Rothman, W., Gizmodo, "HP's Windows 7 Slate Device Revealed by Steve Ballmer," (<http://gizmodo.com/5442200/hps-windows-7-slate-device-revealed-by-steve-ballmer>), published Jan. 6, 2010, 8 pages.
- Smith, T., RegHardware.com, "First fondleslab found in 1970s kid TV sci-fi gem," ([http://www.reghardware.com/2011/02/07/apple\\_ipad\\_tomorrow\\_people/print.html](http://www.reghardware.com/2011/02/07/apple_ipad_tomorrow_people/print.html)), published Feb. 7, 2011, 3 pages.
- The Internet Movie Database, "The Tomorrow People," (<http://www.imdb.com/title/tt0069647/>), retrieved Oct. 11, 2011, 5 pages.
- 01net, "Fiche Technique Philips SPH8008," (<http://www.01net.com/fiche-produit/fiche-technique-7075/cadres-numeriques-philips-sph8008/>), retrieved Nov. 21, 2011, 7 pages.
- 01net, "Fiche Technique Philips SPH8008," (<http://www.01net.com/images/produit/full/philips-sph8008-1.jpg>), retrieved Nov. 21, 2011, 1 page.
- 01net, "Fiche Technique Philips SPH8008," (<http://www.01net.com/images/produit/fall/philips-sph8008-2.jpg>), retrieved Nov. 21, 2011, 1 page.
- 01net, "Fiche Technique Philips SPH8008," (<http://www.01net.com/images/produit/full/philips-sph8008-3.jpg>), retrieved Nov. 21, 2011, 1 page.
- 01net, "Fiche Technique Philips SPH8008," (<http://www.01net.com/images/produit/full/philips-sph8008-4.jpg>), retrieved Nov. 21, 2011, 1 page.
- Amazon, "STL Deutschland Digitaler Bilderrahmen DF-711 B," (<http://www.amazon.de/STL-Deutschland-Digitaler-Bilderrahmen-DF-711/dp/B002D5K6YK>), retrieved Nov. 21, 2011, 4 pages.
- Apple Computer, Inc., "Apple Cinema Display," 1999, 21 pages.
- Apple Computer, Inc., "Setting Up Your Studio Display 15-Inch flat panel monitor," 1999, 37 pages.
- Apple Inc., "iPod touch (2nd generation)," (<http://support.apple.com/kb/ht1353>), retrieved Nov. 21, 2011, 1 page.
- Arrington, M., TechCrunch, "We Want A Dead Simple Web Tablet For \$200. Help Us Build It.," (<http://techcrunch.com/2008/07/21/we-want-a-dead-simple-web-tablet-help-us-build-it/>), published Jul. 21, 2008, 4 pages.
- Bower, G., MacPredictions, "iPod Tablet [Mockup]," (<http://www.macpredictions.com/2009/04/ipod-tablet-mockup.html>), published Apr. 18, 2009, 8 pages.
- Cashmore, P., Mashable, "Apple Tablet: Ultimate Gallery of Concept Designs and Prototypes," (<http://mashable.com/2009/08/07/apple-tablet-gallery/>), published Aug. 7, 2009, 28 pages.
- Justia, "*Apple v. Samsung Electronics Co. Ltd. et al*, Filing: 427 Attachment: 42," (<http://docsjustia.com/cases/federal/district-courts/california/candce/5:2011cv01846/239768/427/42.html>), dated Nov. 28, 2011, 3 pages.
- Justia, "*Apple v. Samsung Electronics Co. Ltd. et al*, Filing: 427 Attachment: 43," (<http://docsjustia.com/cases/federal/district-courts/california/candce/5:2011cv01846/239768/427/43.html>), dated Nov. 28, 2011, 3 pages.
- Justia, "*Apple v. Samsung Electronics Co. Ltd. et al*, Filing: 427 Attachment: 4," (<http://docsjustia.com/cases/federal/district-courts/california/candce/5:2011cv01846/239768/427/4.html>), dated Nov. 28, 2011, 3 pages.
- Focus Online, "Rollei DF8 DVB-T," ([http://www.focus.de/digital/foto/rollei-df8-dvb-t-femsehen-im-bilderrahmen\\_did\\_27152.html](http://www.focus.de/digital/foto/rollei-df8-dvb-t-femsehen-im-bilderrahmen_did_27152.html)), published Feb. 18, 2010, 3 pages.
- Foto-Branche.de, "Kodak EasyShare S730: Digitaler Bilderrahmen mit integriertem Akku," (<http://www.foto-branche.de/news/singleview/browse/2/article/kodak-easyshare-s730-digitaler-bilderrahmen-mit-integriertem-akku/2.html>), published Jul. 13, 2009, 2 pages.
- Fotofabrikas, "AgfaPhoto AF 5087 MS 8," ([http://www.fotofabrikas.lt/data/images/catalog\\_pics/n\\_preview/Skaitmeniniai%20remeliai%20AgfaPhoto%20AF%205087%20MS%20%20skaitmeninis%20r%20melis\\_01.jpg](http://www.fotofabrikas.lt/data/images/catalog_pics/n_preview/Skaitmeniniai%20remeliai%20AgfaPhoto%20AF%205087%20MS%20%20skaitmeninis%20r%20melis_01.jpg)), retrieved Nov. 22, 2011, 1 page.
- Fotofabrikas, "AgfaPhoto AF 5087 MS 8," (<http://www.fotofabrikas.lt/en/items/Digital-Frames/Digital-photo-frames/2636ee4.2-AgfaPhoto-AF-5087-MS-8.html>), retrieved Nov. 21, 2011, 5 pages.
- Funamizu, M., PetitInvention, "(iPod Touch + iMac + Macbook Air)/3," (<http://petit invention.wordpress.com/2008/05/03/ipod-touch-imac-macbook-air-3/>), published May 3, 2008, 4 pages.
- Kahney, L., Cult of Mac, "Mac Air Tablet Mockup From Isamu Sanada," (<http://www.cultofmac.com/1952/mac-air-tablet-mockup-from-isamu-sanada/>), published May 6, 2008, 13 pages.
- KingVision, "Digital Photo Frame," ([http://www.sz-kingvision.com/product.php?type\\_id=1&weblan=e](http://www.sz-kingvision.com/product.php?type_id=1&weblan=e)), retrieved Nov. 21, 2011, 2 pages.
- KingVision, "DPF-1902," ([http://www.sz-kingvision.com/product\\_disp.php?productid=24&weblan=e](http://www.sz-kingvision.com/product_disp.php?productid=24&weblan=e)), retrieved Nov. 21, 2011, 3 pages.
- Kowalski, M., "Review: Kodak EasyShare S730," Digital Picture Frame Review, (<http://www.digitalpictureframereview.com/2009/07/review-kodak-easyshare-s730>), published Jul. 17, 2009, 4 pages.
- Lazar, L., Cult of Mac, "Mac Pad Mock Up," (<http://www.cultofmac.com/4921/mac-pad-mock-up/>), published Nov. 19, 2008, 12 pages.
- My Burmese Blog, "Apple Touch Screen Netbook Prototypes Hit The Web," (<http://www.htooayzar.com/myblog/2009/03/apple-touch-screen-netbook-prototypes-hit-the-web/>), published Mar. 12, 2009, 10 pages.
- Netzwelt, "Rollei DF8 DVB-T," (<http://www.netzwelt.de/news/81537-rollei-df8-dvb-t-test-digitaler-bilderrahmen-mini-fernseher.html>), retrieved Nov. 21, 2011, 10 pages.
- Samsung, "Samsung Introduces UltraThin Touch of Color Photo Frame," ([http://www.samsung.com/us/news/newsPreviewRead.do?news\\_seq=13462](http://www.samsung.com/us/news/newsPreviewRead.do?news_seq=13462)), published May 23, 2009, 2 pages.
- Samsung, "Samsung's Digital Photo Frames," ([http://www.samsung.co/hk\\_en/consumer/detail/productPreviewRead.do?model\\_cd=LP08IPLSB/XK&group=photography&type=photo-frame&subtype=photo-frame](http://www.samsung.co/hk_en/consumer/detail/productPreviewRead.do?model_cd=LP08IPLSB/XK&group=photography&type=photo-frame&subtype=photo-frame)), retrieved Nov. 21, 2011, 4 pages.
- Savov, V., Engadget, "NVIDIA Tegra Tablet prototype hands-on," (<http://www.engadget.com/2009/11/27/nvidia-tegra-tablet-prototype-hands-on/>), published Nov. 27, 2009, 5 pages.
- Savov, V., Engadget, "NVIDIA Tegra tablet prototype hands-on," (<http://www.engadget.com/photos/nvidia-tegra-tablet-prototype/#2485983>), published Nov. 27, 2009, 2 pages.
- Savov, V., Engadget, "NVIDIA Tegra tablet prototype hands-on," (<http://www.engadget.com/photos/nvidia-tegra-tablet-prototype/#2485984>), published Nov. 27, 2009, 2 pages.
- Savov, V., Engadget, "NVIDIA Tegra tablet prototype hands-on," (<http://www.engadget.com/photos/nvidia-tegra-tablet-prototype/#2485985>), published Nov. 27, 2009, 2 pages.

- Savov, V., Engadget, "NVIDIA Tegra tablet prototype hands-on," (<http://www.engadget.com/photos/nvidia-tegra-tablet-prototype/#2485986>), published Nov. 27, 2009, 2 pages.
- Savov, V., Engadget, "NVIDIA Tegra tablet prototype hands-on," (<http://www.engadget.com/photos/nvidia-tegra-tablet-prototype/#2485987>), published Nov. 27, 2009, 2 pages.
- Savov, V., Engadget, "NVIDIA Tegra tablet prototype hands-on," (<http://www.engadget.com/photos/nvidia-tegra-tablet-prototype/#2485988>), published Nov. 27, 2009, 2 pages.
- Savov, V., Engadget, "NVIDIA Tegra tablet prototype hands-on," (<http://www.engadget.com/photos/nvidia-tegra-tablet-prototype/#2485989>), published Nov. 27, 2009, 2 pages.
- Savov, V., Engadget, "NVIDIA Tegra tablet prototype hands-on," (<http://www.engadget.com/photos/nvidia-tegra-tablet-prototype/#2485990>), published Nov. 27, 2009, 2 pages.
- Savov, V., Engadget, "NVIDIA Tegra tablet prototype hands-on," (<http://www.engadget.com/photos/nvidia-tegra-tablet-prototype/#2485991>), published Nov. 27, 2009, 2 pages.
- Savov, V., Engadget, "NVIDIA Tegra tablet prototype hands-on," (<http://www.engadget.com/photos/nvidia-tegra-tablet-prototype/#2485992>), published Nov. 27, 2009, 2 pages.
- Schulze, S. and Gratz, I., "1999 | Studio Display," in Apple Design, pp. 144-145, Hatje Cantz Verlag, Ostfildern, Germany (2011).
- Softgate, "Fujifilm FinePix Real 3D V1," ([http://www.softgate.ch/ger\\_details\\_31383/Fujifilm\\_FinePix\\_Real\\_3D\\_V1\\_Viewer\\_8TFT.html](http://www.softgate.ch/ger_details_31383/Fujifilm_FinePix_Real_3D_V1_Viewer_8TFT.html)), published Apr. 16, 2010, 2 pages.
- Testberichte.de, "Fuji FinePix Real 3D V1," (<http://www.testberichte.de/p/philipstests/digital-photoframe-sph8008-testbericht.html>), retrieved Nov. 21, 2011, 3 pages.
- Testberichte.de, "Philips Digital PhotoFrame SPH8008," (<http://www.testberichte.de/p/philips-tests/digital-photoframe-sph8008-testbericht.html>), retrieved Nov. 21, 2011, 4 pages.
- Touch User Guide, "What will the new Apple Tablet look like? Apple tablet images leaked?," (<http://www.touchuserguide.com/2009/07/29/what-will-the-new-apple-tablet-look-like/>), published Jul. 29, 2009, 29 pages.
- Toxel.com, "12 Cool Apple Tablet Concepts," (<http://www.toxel.com/tech/2009/08/31/12-cool-apple-tablet-concepts/>), published Aug. 31, 2009, 16 pages.
- Verkehrsrundschau, "Details zum Digitalen Bilderrahmen," ([http://www.verkehrsrundschau.de/fotowettbewerb-mein-tag-der-logistik-835123.html?\\_apg=2](http://www.verkehrsrundschau.de/fotowettbewerb-mein-tag-der-logistik-835123.html?_apg=2)), published Apr. 27, 2009, 1 page.
- Vilas-Boas, R., "Nokia I.D.," (<http://rdvb-designshowcase.blogspot.com/p/cheddar-1-2009.html>), retrieved Nov. 7, 2011, 6 pages.
- Yatego Shopping, "Lenco Digitaler Bilderrahmen DF-911 B," (<http://www.yatego.com/index.htm?cl=spotshopping&popup=media&pid=4a13d0ce891ff>), retrieved Nov. 21, 2011, 1 page.
- Ballmer, S., Spiegel Online, "Bill Gates, Tablet PC: 'Mira' war 2002 die große Vision des Microsoft-Gründers—kam aber wohl zu früh für den Markt," (<http://www.spiegel.de/netzwelt/gadgets/bild-670427-46770.html>), products announced 2002, 4 pages.
- Baller, S., Spiegel Online, "Tablet PC," (<http://www.spiegel.de/netzwelt/gadgets/0,15181670427,00.html>), published Jan. 6, 2010, 6 pages.
- Cesweb, "MPIO," ([http://www.cesweb.org/shared\\_files/innovations/innovations\\_2003/1616/mainphoto1616.jpg](http://www.cesweb.org/shared_files/innovations/innovations_2003/1616/mainphoto1616.jpg)), retrieved Feb. 24, 2012, 1 page.
- Chip Online, "VIA: Zwitter-PC für Schöngesteir," ([http://www.chip.de/ii/202812385\\_78f68afa8e.jpg](http://www.chip.de/ii/202812385_78f68afa8e.jpg)), published May 8, 2002, 1 page.
- Chip Online, "VIA: Zwitter-PC für Schöngesteir," ([http://www.chip.de/news/VIA-Zwitter-PC-fuer-schoengeister\\_34204096.html](http://www.chip.de/news/VIA-Zwitter-PC-fuer-schoengeister_34204096.html)), published May 8, 2002, 3 pages.
- Cnet, "Sony Clie," (<http://reviews.cnet.com/sc/30733801-2-440-overview-1.gif>), Feb. 26, 2012, 1 page.
- Computer Museum, "Toshiba Dynapad T100X (1992)," (<http://www.computermuseum.li/Testpage/Toshiba-Dynapad-1992.htm>), product announced Nov. 1992, 1 page.
- De Herrera, C., tabletpctalk, "Tatung Tablet PC Picture," (<http://www.tabletpctalk.com/pictures/tatung.shtml>), 2003, 3 pages.
- Dg2000, Flickr, "Sony CLIE PEG-TH55/E1," (<http://www.flickr.com/photos/derekwilkinson/1323901259/>), photo taken Sep. 4, 2007, 2 pages.
- DigiBarn Computer Museum, "Image of the GO tablet," (<http://www.digibarn.com/collections/systems/go/DSC02917.JPG>), retrieved Feb. 24, 2012, 1 page.
- Digibarn Computer Museum, "Image of the GO tablet," (<http://www.digibarn.com/collections/systems/go/DSCO2942.JPG>), retrieved Feb. 24, 2012, 1 page.
- Falcone, J., Cnet, "Digitalway MPIO-FL100 (128 MB)," ([http://reviews.cnet.com/mp3-players/digitalway-mpio-fl100-128/4505-6490\\_7-20763548.html](http://reviews.cnet.com/mp3-players/digitalway-mpio-fl100-128/4505-6490_7-20763548.html)), published Apr. 18, 2003, 8 pages.
- Gilder, G. "Digital Dark Horse—Newspapers," Forbes ASAP, published Oct. 25, 1993, 2 pages.
- Gollwitzer, M., et al., Chip Online, "Microsofts CeBIT-Neuheiten 2002," ([http://www.chip.de/artikel/c\\_druckansicht\\_9668117.html](http://www.chip.de/artikel/c_druckansicht_9668117.html)), published Mar. 13, 2002, 5 pages.
- Heimi, "MPIO," (<http://www.heimi.net/FlashPlayer/MPIOFL100/pics/01a%20FL100Backlight.jpg>), retrieved Feb. 24, 2012, 1 page.
- Heomkino Markt, "CeBIT 2004 News: FALTRON tablet—TFT-Monitor von LG mit Stifteingabemöglichkeit/Ideal für Industrie- und Designanwendungen," (<http://www.heimkinomarkt.de/News/643/LG/CeBIT%202004%20News%20FLATRON%20TabletTFT%20Monitor%20von/>), published Mar. 25, 2004, 3 pages.
- Justia, "*Apple v. Samsung Electronics Co. Ltd. et al.*, Filing: 166 Attachment: 10," (<http://docs.justia.com/cases/federal/district-courts/california/candce/5:2011cv01846/239768/166/10.html>), dated Aug. 22, 2011, 2 pages.
- Justia, "*Apple v. Samsung Electronics Co. Ltd. et al.*, Filing: 166 Attachment: 11," (<http://docs.justia.com/cases/federal/district-courts/california/candce/5:2011cv01846/239768/166/11.html>), dated Aug. 22, 2011, 2 pages.
- Justia, "*Apple v. Samsung Electronics Co. Ltd. et al.*, Filing: 166 Attachment: 14," (<http://docs.justia.com/cases/federal/district-courts/california/candce/5:2011cv01846/239768/166/14.html>), dated Aug. 22, 2011, 2 pages.
- Justia, "*Apple v. Samsung Electronics Co. Ltd. et al.*, Filing: 166 Attachment: 15," (<http://docs.justia.com/cases/federal/district-courts/california/candce/5:2011cv01846/239768/166/15.html>), dated Aug. 22, 2011, 2 pages.
- Justia, "*Apple v. Samsung Electronics Co. Ltd. et al.*, Filing: 166 Attachment: 16," (<http://docs.justia.com/cases/federal/district-courts/california/candce/5:2011cv01846/239768/166/16.html>), dated Aug. 22, 2011, 2 pages.
- Justia, "*Apple v. Samsung Electronics Co. Ltd. et al.*, Filing: 166 Attachment: 9," (<http://docs.justia.com/cases/federal/district-courts/california/candce/5:2011cv01846/239768/166/9.html>), dated Aug. 22, 2011, 2 pages.
- Justia, "*Apple v. Samsung Electronics Co. Ltd. et al.*, Filing: 456 Attachment: 5," (<http://docs.justia.com/cases/federal/district-courts/california/candce/5:2011cv01846/239768/456/5.html>), dated Dec. 7, 2011, 3 pages.
- Justia, "*Apple v. Samsung Electronics Co. Ltd. et al.*, Filing: 456 Attachment: 6," (<http://docs.justia.com/cases/federal/district-courts/california/candce/5:2011cv01846/239768/456/6.html>), dated Dec. 7, 2011, 3 pages.
- Justia, "*Apple v. Samsung Electronics Co. Ltd. et al.*, Filing: 456 Attachment: 7," (<http://docs.justia.com/cases/federal/district-courts/california/candce/5:2011cv01846/239768/456/7.html>), dated Dec. 7, 2011, 3 pages.
- Long, B., Macworld, "PL500 LCD Pen Tablet System," (<http://images.macworld.com/images/legacy/2001/02/images/content/wacom.gif>), published Feb. 1, 2001, 1 page.
- Long, B., Macworld, "PL500 LCD Pen Tablet System," (<http://www.macworld.com/article/1938/2001/02/wacomtablet.html>), published Feb. 1, 2001, 1 page.
- Markoff, J., "A Media Pioneer's Quest: Portable Electronic Newspapers," The New York Times, published Jun. 28, 1992, p. 11.
- Microsoft, "Bill Gates Highlights the Magic of Consumer Software And the Coming Digital Decade at Consumer Electronics Show," (<http://www.microsoft.com/presspass/press/2002/jan02/01-07ces2002keynotepr.mspx>), published Jan. 7, 2002, 3 pages.
- Monitor4u, "Flatron L1530TM," (<http://www.monitor4u.co.kr/review/review4u/content.asp?idx=580&leftcode=16>), published Mar. 17, 2004, 7 pages.

- Old Computers, "Toshiba T100-X Dynapad," (<http://www.old-computers.com/museum/computer.asp?st=1&c=801>), product released 1993, 2 pages.
- Oullette, D., "Dynapad weighs in at just 3.3 pound," *Info World*, vol. 15, Issue 31, Aug. 2, 1993, 2 pages.
- PDA Museum, "Sony Clie," ([http://www.pdamuseum.com/sony\\_clie/clie\\_pics/th-55j2.jpg](http://www.pdamuseum.com/sony_clie/clie_pics/th-55j2.jpg)), retrieved Feb. 26, 2012, 1 page.
- Presstime, "Life After Viewtron? Enter the E-Paper," *Presstime*, published Aug. 1993, p. 18-19.
- Scrapin\_frame, s10forum, "fs: 2 lg flatron tablet monitors," (<http://www.s10forum.com/forum/f296/fs-2-lg-flatron-tablet-monitors-483210/>), published Nov. 27, 2011, 5 pages.
- Sony, "The Sony CLIÉ PEG-TH55 heralds The Next Generation Of Digitaler Organisers," (<http://dpnow.com/595.html>), published Feb. 13, 2004, 2 pages.
- Tatung, "Comdex Fall 2003 Tatung Booth# 10248," (<http://www.tatung.com/en/news/comdex2003.htm>), published Nov. 17, 2003, 2 pages.
- Toshiba, "Dynapad T100X," product announced Nov. 1992, 2 pages.
- Wacom, "Company History, PL-500," (<http://wacom.jp/en/company/history/>), product released Jun. 2000, 1 page.
- Wikimedia, "MPIO," ([http://upload.wikimedia.org/wikipedia/commons/e/e9/M-Pio\\_FL100.jpg](http://upload.wikimedia.org/wikipedia/commons/e/e9/M-Pio_FL100.jpg)), retrieved Feb. 24, 2012, 1 page.
- Wiley, M., IGN, "MPIO FL100 Review," (<http://uk.ign.com/articles/2003/01/21/mpio-fl100-review>), published Jan. 21, 2003, 4 pages.
- "A Day in the Life of InfoLink," Stanford University Libraries, published May 1, 2003.
- "The Oracle: The Personal Computer of the Year 2000," Stanford University Libraries.
- "The Organizer: The Personal Computer of the Year 2000," Stanford University Libraries.
- Alicexpress.com, "WACOM PL-500 15" LCD Tablet Mint," (<http://www.aliexpress.com/product-fm/430172068-WACOM-PL-500-15-LCD-Tablet-Mint-Worldwide-Free-Shipping-wholesalers.html>), accessed Nov. 14, 2011, 3 pages.
- Amazon.com, "Digitalway MPIO FL100 128 MB MP3 Player" (<http://www.amazon.com/Digitalway-MPIO-FL100-128-Player/dp/B00008V6NI>), accessed Nov. 17, 2011, 7 pages.
- Amazon.com, "Whirlpool Gold: GH7208XRS 2.0 cu. ft. Velos Speedcook Over the Range Microwave Oven," (<http://www.amazon.com/Whirlpool-Gold-GH7208XRS-Speedcook-Microwave/dp/B000ZIPHM8>), accessed May 23, 2012, 5 pages.
- AndroidTabletFanatic.com "16 Old-Skool Tablets Rocking it Before the iPad," (<http://www.androidtabletfanatic.com/android-tablet-news/16-old-skool-tablets-rocking-it-before-the-ipad/>), published May 16, 2011, 10 pages.
- Blandford, "Nokia N92 Preview," ([http://www.allaboutsymbian.com/features/item/Nokia\\_92\\_Preview.php](http://www.allaboutsymbian.com/features/item/Nokia_92_Preview.php)), published Nov. 23, 2005, 10 pages.
- Block, "Olympus @ CES Hands-on with the m:robe MR 500i and MR-100," *Engadget.com*, (<http://www.engadget.com/2005/01/10/olympus-ces-hands-on-with-the-m-robe-mr-500i-and-mr-100/>), published January 10, 2005, 3 pages.
- Cell Phones.About.com, "More pictures of the LG KG800," ([http://cellphones.about.com/library/b1-pi-lg\\_kg800.htm](http://cellphones.about.com/library/b1-pi-lg_kg800.htm)), accessed Feb. 13, 2012, 1 page.
- Clarke, "Newspad by Arthur C. Clarke fro 2001: A Space Odyssey," (<http://www.technovelgy.com/ct/content.asp?Bnum=529>), published 1968, 3 pages.
- Computer.biz, "Tatung Tablet PC," ([http://www.computex.biz/tatung/Default.aspx?pagetype=ProductDetail&pdt\\_id=36&cid=3...](http://www.computex.biz/tatung/Default.aspx?pagetype=ProductDetail&pdt_id=36&cid=3...)), accessed Nov. 4, 2011, 3 pages.
- Flickr.com, "Apple Graphics Tablet" ([http://farm3.static.flickr.com/2691/4126733086\\_b24c987b0e\\_o.jpg](http://farm3.static.flickr.com/2691/4126733086_b24c987b0e_o.jpg)), accessed Nov. 15, 2011, 1 page.
- Fried, "Live-blogging Steve Ballmer," *CNET*, ([http://www.cnet.com/8301-31045\\_1-10426723-269.html?tag=mncol%3btxt](http://www.cnet.com/8301-31045_1-10426723-269.html?tag=mncol%3btxt)), published Jan. 6, 2010, 6 pages.
- Itbusiness.ca, "Microsoft Mira eHome Wireless Smart Display," ([http://www.itbusiness.ca/images/articles/Jun10/clip\\_image003\\_0087.jpg](http://www.itbusiness.ca/images/articles/Jun10/clip_image003_0087.jpg)), accessed Nov. 15, 2011, 1 page.
- iTechNews.net, "Samsung K3 MP3 Player," (<http://www.itechnews.net/2006/12/02/samsung-k3-mp3-player/>), published Dec. 2, 2006, 9 pages.
- Justia, "*Apple v. Samsung Electronics Co. Ltd. et al.*," Filing: 943 Attachment: 5," (<http://docs.justia.com/cases/federal/district-courts/california/candce/5:5011cv01846/239768/943/5.html>), dated May 18, 2012, 2 pages.
- Knowyourmobile.com, "LG KG800 technical specifications," ([http://www.knowyourmobile.com/lg/lgkg800chocolate/lgkg800reviews/137/lg\\_kg800\\_technical\\_specifications.html](http://www.knowyourmobile.com/lg/lgkg800chocolate/lgkg800reviews/137/lg_kg800_technical_specifications.html)), published Mar. 9, 2007, 3 pages.
- McCracken, "The iPad. Of 2000. As Envisioned in 1988," *Technologizer.com*, (<http://technologizer.com/2010/05/14/the-ipad-of-2000-as-envisioned-in-1988/>), published May 14, 2010, 12 pages.
- Mel et al., "Tablet: Personal Computer in the Year 2000," *Communications of the ACM* 31:638-646, ACM (Jun. 1988).
- Mobilegazette.com, "Nokia N92," (<http://www.mobilegazette.com/nokia-n92-051102.htm>), published Nov. 2, 2005, 2 pages.
- Needleman, "Hands-on with the JooJoo," ([http://news.cnet.com/8301-19882\\_3-10410960-250.html](http://news.cnet.com/8301-19882_3-10410960-250.html)), *CNET News*, published Dec. 7, 2009, 31 pages.
- Newlaunches.com, "Pidion BM-200 sleek Windows CE PDA phone from Bluebird," ([http://www.newlaunches.com/archives/pidion\\_bm200\\_sleek\\_windows\\_ce\\_pda\\_phone\\_from\\_bluebird.php](http://www.newlaunches.com/archives/pidion_bm200_sleek_windows_ce_pda_phone_from_bluebird.php)), published Dec. 15, 2005, 3 pages.
- NYTimes.com, "iRiver U10 (1GB)," (<http://www.nytimes.com/technology/personaltech/music-players/iRiver-U10-1GB-/31432102.html>), published Feb. 12, 2012, 2 pages.
- Patel, "The HP Slate" (<http://www.engadget.com/2010/01/06/the-hp-slate/>), *Engadget.com*, published Jan. 6, 2010, 4 pages.
- PDAdb.net, "Acer n20 Specs," (<http://pdadb.net/index.php?m=specs&id=257&c=acern20>), published May 13, 2005, 3 pages.
- PDAdb.net, "Casio Computer IT-10 M20BR Specs," ([http://pdadb.net/index.php?m=specs&id=95&c=casio\\_cassiopeia\\_it-10\\_m20br](http://pdadb.net/index.php?m=specs&id=95&c=casio_cassiopeia_it-10_m20br)), published Dec. 30, 2004, 3 pages.
- PDAdb.net, "Dell Axim X3 Basic Specs," ([http://pdadb.net/index.php?m=specs&id=81&c=dell\\_axim\\_x3\\_basic](http://pdadb.net/index.php?m=specs&id=81&c=dell_axim_x3_basic)), published Dec. 30, 2004, 3 pages.
- PDAdb.net, "MiTAC Mio 338 Plus Digi-Walker Specs," ([http://pdadb.net/index.php?m=specs&id=60&c=mitac\\_mio\\_338\\_plus\\_digi-walker](http://pdadb.net/index.php?m=specs&id=60&c=mitac_mio_338_plus_digi-walker)), published Dec. 25, 2004, 3 pages.
- PDAdb.net, "O2 XDA (HTC Wallaby) Specs," ([http://pdadb.net/index.php?m=specs&id=117&c=o2\\_xda\\_htc\\_wallaby](http://pdadb.net/index.php?m=specs&id=117&c=o2_xda_htc_wallaby)), published Feb. 3, 2005, 3 pages.
- PDAdb.net, "Sony Clie PEG-SL10/PEG-SL10U/PEG-S10E Specs," ([http://pdadb.net/index.php?m=specs&id=1198&c=sony\\_clie\\_peg-s10\\_peg-s110u\\_peg-s110e](http://pdadb.net/index.php?m=specs&id=1198&c=sony_clie_peg-s10_peg-s110u_peg-s110e)), published Mar. 4, 2008, 3 pages.
- PDAdb.net, "Sony Clie PEG-T665C/PEG-T675C Specs," ([http://pdadb.net/index.php?m=specs&id=1192&c=sony\\_clie\\_peg-t665c\\_peg-t675c](http://pdadb.net/index.php?m=specs&id=1192&c=sony_clie_peg-t665c_peg-t675c)), published Mar. 4, 2008, 3 pages.
- PDAdb.net, "Toshiba Genio e330 Specs," ([http://pdadb.net/index.php?m=specs&id=29&c=toshiba\\_genio\\_e330](http://pdadb.net/index.php?m=specs&id=29&c=toshiba_genio_e330)), published Dec. 9, 2004, 3 pages.
- PDAdb.net, "Toshiba Genio e570 Specs," ([http://pdadb.net/index.php?m=specs&id=229&c=toshiba\\_genio\\_e570](http://pdadb.net/index.php?m=specs&id=229&c=toshiba_genio_e570)), published May 4, 2006, 3 pages.
- Ricker, "LG's KE850 PRADA official: iPhone says, wha?" *Engadget.com*, (<http://www.engadget.com/2007/01/18/lgs-ke850-prada-official-iphone-says-wha/>), published Jan. 18, 2007, 4 pages.
- Ricker, "The Pidion BM-200: it's time to move to Seoul," (<http://www.engadget.com/2005/10/04/the-pidion-bm-200-its-time-to-move-to-seoul/>), *Engadget.com*, published Oct. 4, 2005, 4 pages.
- Rojas, "Hands-on with the Nokia N92," *Engadget.com*, (<http://www.engadget.com/2005/12/01/hands-on-with-the-nokia-n92/>), published Dec. 1, 2005, 4 pages.
- S. Dimitris, "Pidion BM200 Smartphone," *PDASNews*, ([www.pdasnews.com/articles/pidion-bm200-smartphone.html](http://www.pdasnews.com/articles/pidion-bm200-smartphone.html)), accessed Mar. 7, 2012, 2 pages.
- Salestores.com, "LG L1530TM Tablet LCD Monitor," (<http://salestores.com/lgl1talcdmos.html>), accessed Nov. 17, 2011, 2 pages.
- WebdesignerDepot.com "The Evolution of Cell Phone Design Between 1983-2009" (<http://www.webdesignerdepot.com/2009/05/the-evolution-of-cell-phone-design-between-1983-2009/>), accessed May 6, 2011, 56 pages.
- Wikipedia.org, "CLIEÉ," (<http://en.wikipedia.org/wiki/CLIE%C3%89>), last modified February 12, 2011, 3 pages.
- Wikipedia.org, "E-Ten" (<http://en.wikipedia.org/wiki/E-TEN>), last modified Dec. 15, 2010, 2 pages.



- Wikipedia.org, "File:LG KE850 Prada Hauptmentü.jpg," ([http://en.wikipedia.org/wiki/File:LG\\_KE850\\_Prada\\_Hauptmen%C3%BC.jpg](http://en.wikipedia.org/wiki/File:LG_KE850_Prada_Hauptmen%C3%BC.jpg)), accessed Feb. 12, 2012, 4 pages.
- Wikipedia.org, "iPAQ" (<http://en.wikipedia.org/wiki/IPAQ>), last modified May 4, 2011, 7 pages.
- Wikipedia.org, "Pocket viewer," ([http://en.wikipedia.org/wiki/Pocket\\_viewer](http://en.wikipedia.org/wiki/Pocket_viewer)), last modified Apr. 10, 2011, 4 pages.
- Wikipedia.org, "Zire Handheld" ([http://en.wikipedia.org/wiki/Zire\\_Handheld](http://en.wikipedia.org/wiki/Zire_Handheld)), last modified Dec. 11, 2010, 4 pages.
- Bhargal, S., O'Reilly Media, "The Page Turn Effect in Flash MX," (<http://oreilly.com/javascript/archive/flashhacks.html>), published Sep. 3, 2004, 3 pages.
- FlippingBook, "Flipping Book Publisher 2.2 Demonstrations," (<http://flippingbook.com/products/publisher/#demonstrations>), retrieved Apr. 25, 2012, 2 pages.
- Hosteasy Solutions, "Flipping Book Publisher 2.0," (<http://www.hosteasysolutions.com/what-we-offer.html>), retrieved Apr. 25, 2012, 2 pages.
- Skyhool, naver.com, "FLEX," (<http://blog.naver.com/PostView.nhn?blogId=skyhool&logNo=150027158023&widgetTypeCall=true>), published Jan. 25, 2008, 3 pages.
- Block, "Philips PET830 and PET1030 media players," Engadget, (<http://www.engadget.com/2006/11/29/philips-pet830-and-pet1030-media-players/>), published Nov. 29, 2006, 2 pages.
- Boggs, "Electrovaya Scribbler SC4000 Review," Tablet PC Review, (<http://www.tabletpcreview.com/default.asp?newsID=1130>), published Apr. 15, 2008, 6 pages.
- Fidler, "Mediamorphosis: Understanding New Media," pp. 220, 222-225, and 236-242, Pine Forge Press, Thousand Oaks, CA (1997).
- Fidler, "Predicting e-readers in 1981: A look back at the future," Associated Press Managing Editors, (<http://www.snd.org/2010/01/predicting-e-readers-in-1981-a-look-back-at-the-future/>) published Jan. 14, 2010, 5 pages.
- Flatley, "BoEye MID700 unveiled with Android OS, vaguely familiar form factor," Engadget.com, ([http://engadget.com/2009/11/11/boeye-mid700-unveiled-with-android-os-vaguely-familiar-form-fac/?icid=eng\\_Dubai\\_art](http://engadget.com/2009/11/11/boeye-mid700-unveiled-with-android-os-vaguely-familiar-form-fac/?icid=eng_Dubai_art)), published Nov. 11, 2009, 2 pages.
- Ganapati, "Hands on With the JooJoo, Formerly Known as CrunchPad," (<http://www.wired.com/gadgetlab/2009/12/hands-on-joo-joo-crunchpad/all/1>), published Dec. 7, 2009, 3 pages.
- Justia, "*Apple v. Samsung Electronics Co. Ltd. et al.*, Filing: 166 Attachment: 2," (<http://docs.justia.com/cases/federal/district-courts/california/candce/5:2011cv01846/239768/166/2.html>), dated Aug. 22, 2011.
- Justia, "*Apple v. Samsung Electronics Co. Ltd. et al.*, Filing: 166 Attachment: 3," (<http://docs.justia.com/cases/federal/district-courts/california/candce/5:2011cv01846/239768/166/3.html>), dated Aug. 22, 2011.
- Justia, "*Apple v. Samsung Electronics Co. Ltd. et al.*, Filing: 166 Attachment: 4," (<http://docs.justia.com/cases/federal/district-courts/california/candce/5:2011cv01846/239768/166/4.html>), dated Aug. 22, 2011.
- Miles, "56 Apple iTablet concept designs: Could any be real?," (<http://www.pocket-lint.com/news/26500/56-apple-it-tablet-concept-designs/>), published Aug. 21, 2009, 14 pages.
- Miller, "MSI shows off 10-inch Android tablet running new Tegra chipset," Engadget.com, (<http://www.engadget.com/2010/01/08/msi-shows-off-10-inch-android-tablet-running-new-tegra-chipset/>), published Jan. 8, 2010, 11 pages.
- Perton, "Samsung digital picture frame stores pics, movies, music," Engadget, (<http://www.engadget.com/2006/03/09/samsung-digital-picture-frame-stores-pics-movies-music/>), published Mar. 9, 2006, 1 page.
- Rothman, "HP's Windows 7 Slate Device Revealed by Steve Ballmer," Gizmodo.com, (<http://gizmodo.com/5442200/hps-windows-7-slate-device-revealed-by-steve-ballmer>), published Jan. 6, 2010, 2 pages.
- Stevens, "ICD confirms Vega tablet, includes Android 2.0, Tegra processor, our hearts," Engadget.com, (<http://www.engadget.com/2009/11/13/icd-confirms-vega-tablet-includes-android-2-0-tegra-processor/>), published Nov. 13, 2009, 2 pages.
- TechLahore.com, "China's Boeye releases 'Apple tablet' before Apple can—TechLahore@GITEX," (<http://www.techlahore.com/2009/11/08/chinas-boeye-releases-apple-tablet-before-apple-can-techlahoregitex/>), published Nov. 8, 2009, 3 pages.
- The Apple Collection, "Apple PowerPad G3 Pro—Apple Design & Prototype," ([www.theapplecollection.com/design/macdesign/Apple\\_PowerPad\\_G3\\_Pro.shtml](http://www.theapplecollection.com/design/macdesign/Apple_PowerPad_G3_Pro.shtml)), updated Oct. 31, 2011, 2 pages.
- The Apple Collection, "MyPal," ([www.theapplecollection.com/design/macdesign/MyPal.shtml](http://www.theapplecollection.com/design/macdesign/MyPal.shtml)), updated Oct. 31, 2011, 2 pages.
- The Apple Collection, "PowerPad," ([www.theapplecollection.com/design/macdesign/PowerPad2.shtml](http://www.theapplecollection.com/design/macdesign/PowerPad2.shtml)), updated Oct. 31, 2011, 2 pages.
- Tingle, "ICD Vega Android 2.0 Tablet Available in 2010 [Vega Android Tablet, Nvidia Tegra Chipset Touting 'Low Cost Tablet' Confirmed]," (<http://nexus404.com/Blog/2009/11/13/icd-vega-android-2-0-tablet-available-in-2010-vega-android-tablet-nvidia-tegra-chipset-touting-low-cost-tablet-confirmed/>), TFTS, published Nov. 13, 2009, 2 pages.
- To, "Boeye MID 700 tablet runs Android with Apple-esque aesthetics," Pcketables.com, (<http://www.pocketables.net/2009/11/boeye-mid-700-tablet-runs-android-with-applesque-aesthetics.html>), published Nov. 12, 2009, 2 pages.
- Topolsky, "Leaked pics of the CrunchPad make it look dangerously close to availability," Engadget.com, (<http://www.engadget.com/2009/04/09/leaked-pics-of-the-crunchpad-make-it-look-dangerously-close-to-a/>), published Apr. 9, 2009, 2 pages.
- Topolsky, "NVIDIA CEO shows off mystery tablet, makes zero statements about mystery tablet," Engadget.com, (<http://www.engadget.com/2009/11/09/nvidia-ceo-shows-off-mystety-tablet-makes-zero-statements-about/>), published Nov. 9, 2009, 1 page.
- Weiss, "Hands-On: NVIDIA Tegra Tablet Prototyp ICD Vega (Video)," (<http://de.engadget.com/2009/11/28/hands-on-nvidia-tegra-tablet-prototyp-icd-vega-video/>), Engadget German, published Nov. 28, 2009, 13 pages.
- Klass, C., "Plastic Logic Reader—erste Partner bekannt," (<http://www.golem.de/0902/65175.html>), published Feb. 10, 2009, 9 pages.
- JKKMobile.com, "Hanvon TouchPad BC10C tablet review," (<http://www.jkkmobile.com/2010/03/hanvon-touchpad-bc10c-tablet-review.html>), published Mar. 13, 2010, 2 pages.
- MacTablet, "More Pictures of MacTablet Revealed ...," (<http://www.mactablet.co.uk/2009/11/more-pictures-of-mactablet-revealed.html>), published Nov. 27, 2009, 3 pages.
- Stromer, G., "CES 2010: Plastic Logic zeigt superflachen und -teuren eBook-Reader Que," (<http://www.cnet.de/41525409/ces-2010-plastic-logic-zeigt-superflachen-und-teuren-ebook-reader-que/>), published Jan. 10, 2010, 2 pages.
- Vantage Emea, "TPT1210-1 Web Tablet," ([http://www.vantageemea.com/technical/User%20Interfaces/Touchscreens/Cutsheets/TPT1210-1%20Web%20Tablet\\_cutsheet.pdf](http://www.vantageemea.com/technical/User%20Interfaces/Touchscreens/Cutsheets/TPT1210-1%20Web%20Tablet_cutsheet.pdf)), published 2008, Belgium, 2 pages.
- Cranfill et al., "Display Screen or Portion Thereof with Animated Graphical User Interface," U.S. Control No. 90/012,756, filed Dec. 31, 2012 (pending ex parte reexamination of U.S. Pat. No. D670,713).
- Cranfill et al., "Display Screen or Portion Thereof with Animated Graphical User Interface," U.S. Control No. 90/012,757, filed Dec. 31, 2012 (pending ex parte reexamination of U.S. Pat. No. D669,906).
- Girvan, R., "Spitfire 40," [http://www.rolandandcaroline.co.uk/html/spitfire\\_40.html](http://www.rolandandcaroline.co.uk/html/spitfire_40.html), accessed Jan. 8, 2013, 4 pages.
- Gorenje Kitchen 2008 Online Catalog, <http://web.archive.org/web/20090301042519/http://page-flip.com/new-demos/03-kitchen-gorenje-2008/index.html>, dated Nov. 3, 2008, accessed Jan. 11, 2013.
- Liesaputra et al., "Creating and Reading Realistic Electronic Books," *Computer*, vol. 42, No. 2, pp. 72-81, IEEE Computer Society (Feb. 2009).
- Untitled Video, <http://cogentlogic.com/apple/>, accessed Jan. 11, 2013.

\* cited by examiner

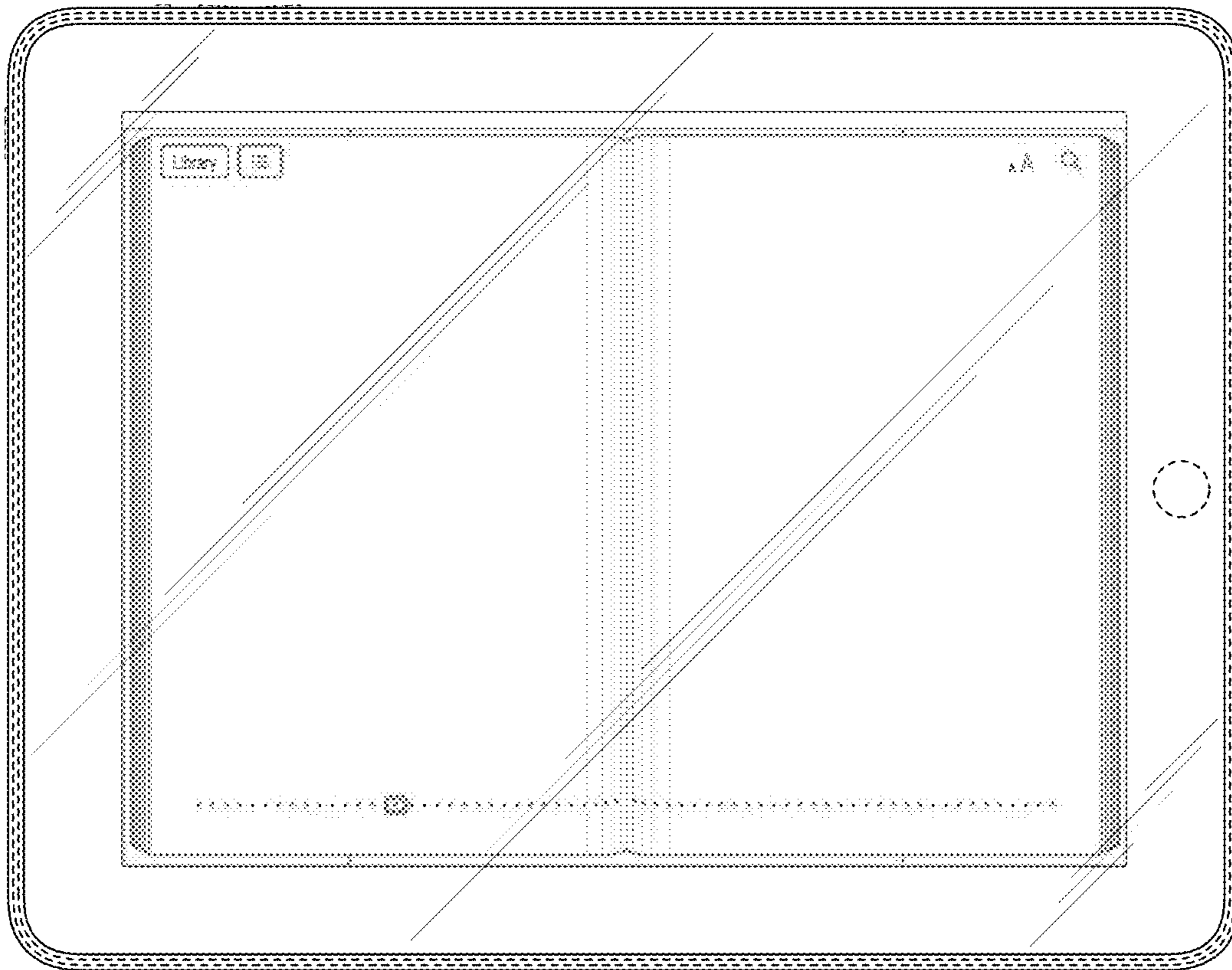
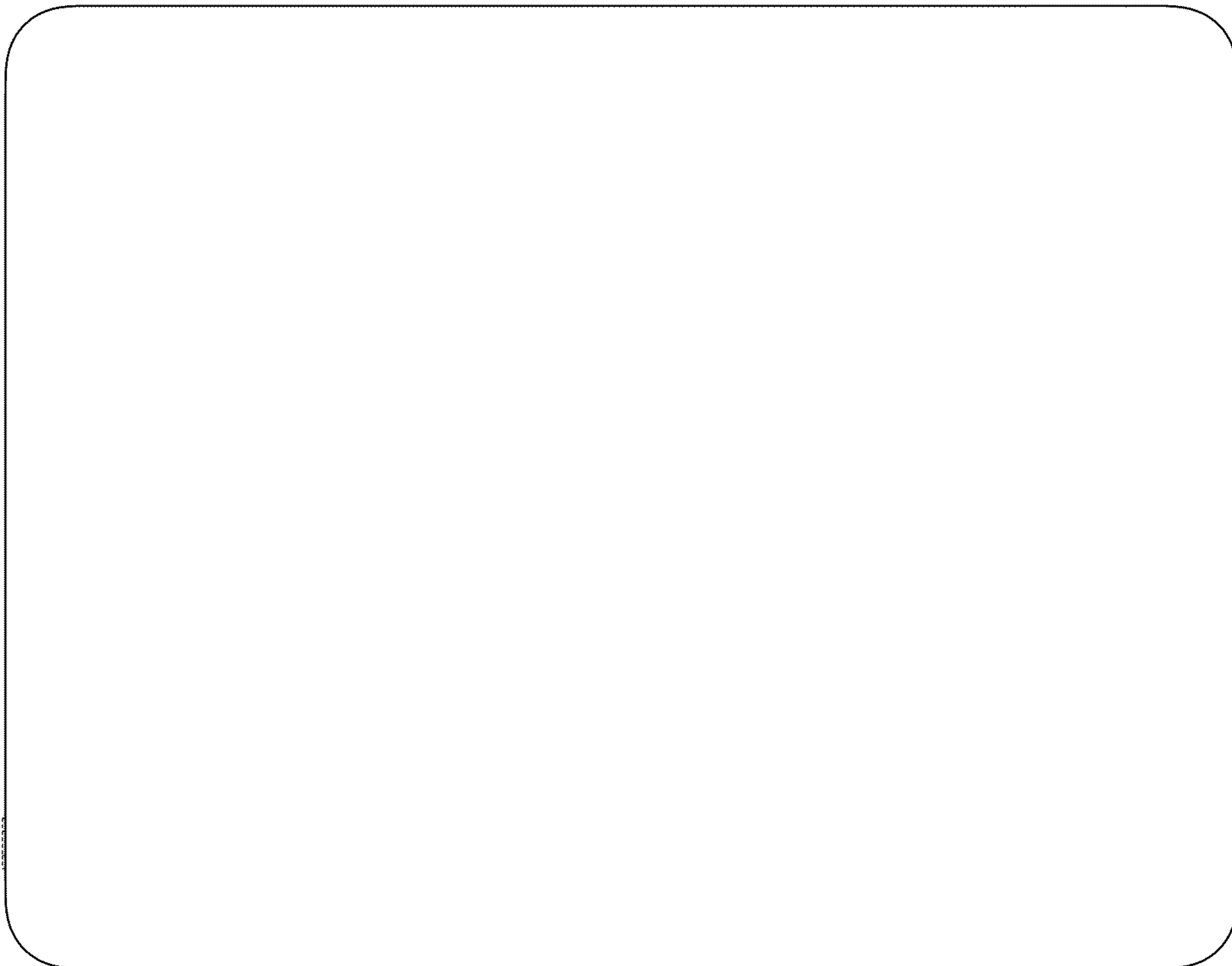
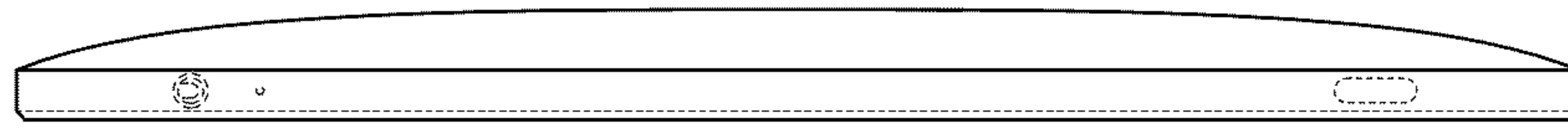


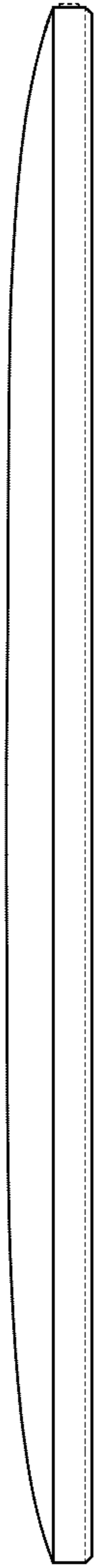
FIG. 1



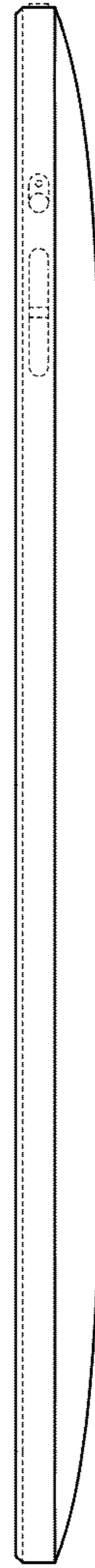
***FIG. 2***



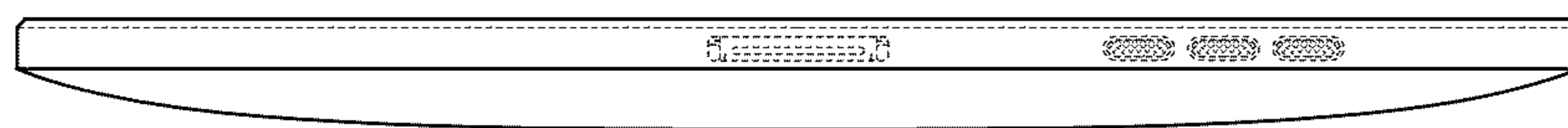
**FIG. 3**



**FIG. 4**



**FIG. 5**



**FIG. 6**

UNITED STATES PATENT AND TRADEMARK OFFICE  
**CERTIFICATE OF CORRECTION**

PATENT NO. : D683,730 S  
APPLICATION NO. : 29/365379  
DATED : June 4, 2013  
INVENTOR(S) : Jody Akana et al.

Page 1 of 6

It is certified that error appears in the above-identified patent and that said Letters Patent is hereby corrected as shown below:

The title page showing the illustrative figure should be deleted to be replaced with the attached title page.

**In the Drawings**

In the drawing sheets, consisting of Figs. 3-6, 9-12, 15-18 and 21-24, should be deleted to be replaced with the drawing sheets, consisting of Figs. 3-6, 9-12, 15-18, as shown on the attached pages.

Signed and Sealed this  
Seventh Day of July, 2015



Michelle K. Lee  
*Director of the United States Patent and Trademark Office*

(12) **United States Design Patent** (10) **Patent No.:** **US D683,730 S**  
**Akana et al.** (45) **Date of Patent:** **\*\* Jun. 4, 2013**

(54) **PORTABLE DISPLAY DEVICE WITH GRAPHICAL USER INTERFACE**

D19/60; 345/169, 901, 905; 348/169; 361/814; 341/122; 346/173; 379/433.01, 433.07, 433.11, 379/433.12, 433.13, 910, 916, 433.06

(75) Inventors: **Jody Akana**, San Francisco, CA (US); **Bartley K. Andre**, Menlo Park, CA (US); **Daniel J. Coster**, San Francisco, CA (US); **Elizabeth Caroline Cranfill**, San Francisco, CA (US); **Daniele De Iullis**, San Francisco, CA (US); **M. Evans Hankey**, San Francisco, CA (US); **Richard P. Howarth**, San Francisco, CA (US); **Mikio Inose**, Cupertino, CA (US); **Jonathan P. Ive**, San Francisco, CA (US); **Steve Jobs**, Palo Alto, CA (US); **Duncan Robert Kerr**, San Francisco, CA (US); **Stephen O. Lemay**, San Francisco, CA (US); **Shin Nishibori**, Portola Valley, CA (US); **Matthew Dean Rohrbach**, San Francisco, CA (US); **Peter Russell-Clarke**, San Francisco, CA (US); **Christopher J. Stringer**, Woodside, CA (US); **Eugene Antony Whang**, San Francisco, CA (US); **Rico Zorkendorfer**, San Francisco, CA (US)

See application file for complete search history.

(56) **References Cited**

**U.S. PATENT DOCUMENTS**

805,678 A 11/1905 Smith  
 2,424,630 A 7/1947 Perez

(Continued)

**FOREIGN PATENT DOCUMENTS**

AU 315078 7/2007  
 CA 72548 5/1993

(Continued)

**OTHER PUBLICATIONS**

<http://book-of-time-3d-screensaver.kryptile-screensavers.qarchive.org/>; Dec. 13, 2004; "Screenshot"; captured Apr. 20, 2011.\*  
 Axiotron, Macworld Expo 2009 Wrap-Up, 4 pages, <http://www.axiotron.com/index.php?id=events>.\*

(Continued)

*Primary Examiner* — Barbara Fox

(74) *Attorney, Agent, or Firm* — Sterne, Kessler, Goldstein & Fox P.L.L.C.

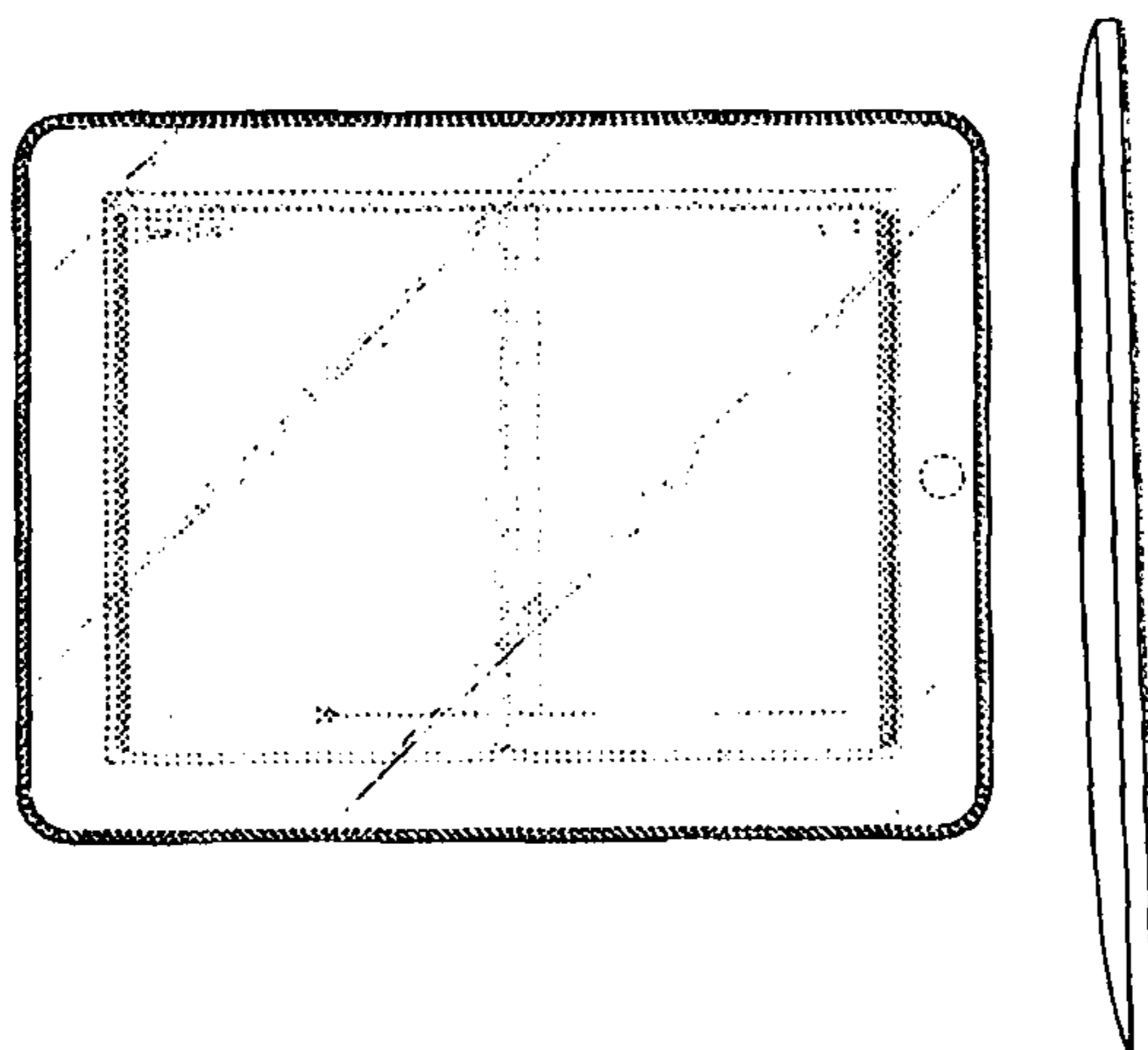
(57) **CLAIM**

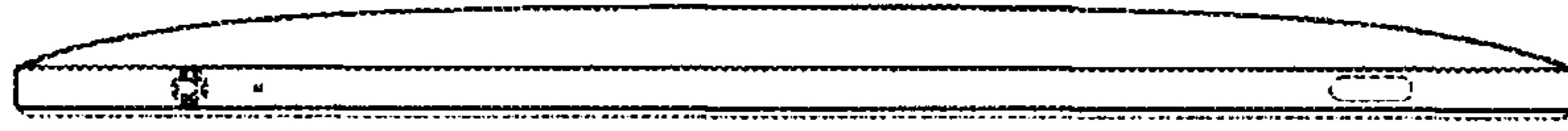
The ornamental design for a portable display device with graphical user interface, as shown and described.

**DESCRIPTION**

FIG. 1 is a front view of a portable display device with graphical user interface showing our new design;  
 FIG. 2 is a rear view thereof;  
 FIG. 3 is a top view thereof;  
 FIG. 4 is a left side view thereof;  
 FIG. 5 is a right side view thereof; and,  
 FIG. 6 is a bottom view thereof.  
 The broken lines shown in the drawings represent unclaimed portions of the portable display device with graphical user interface and form no part of the claimed design.

1 Claim, 6 Drawing Sheets

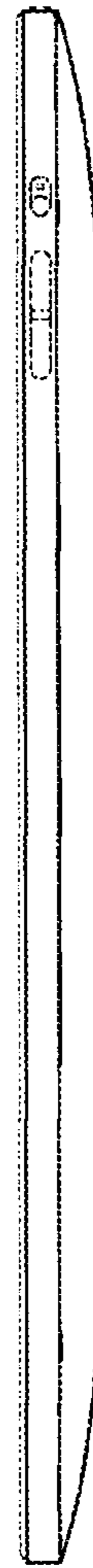




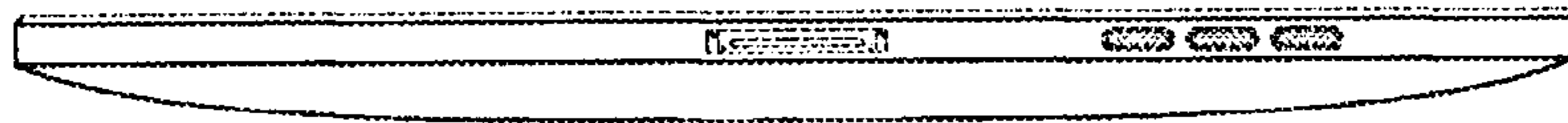
**FIG. 3**



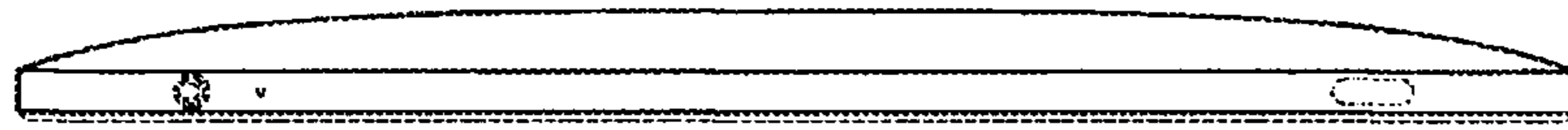
**FIG. 4**



**FIG. 5**



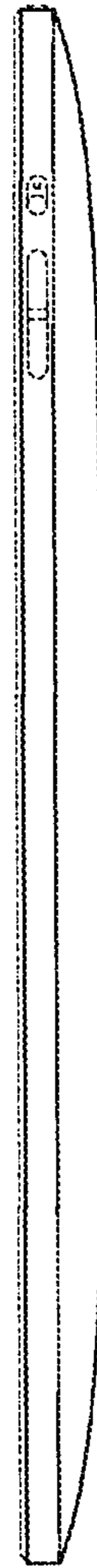
**FIG. 6**



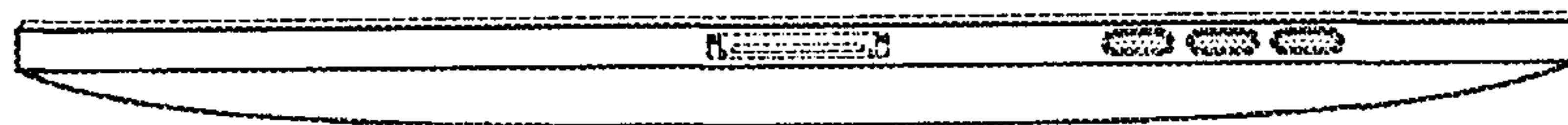
**FIG. 9**



**FIG. 10**

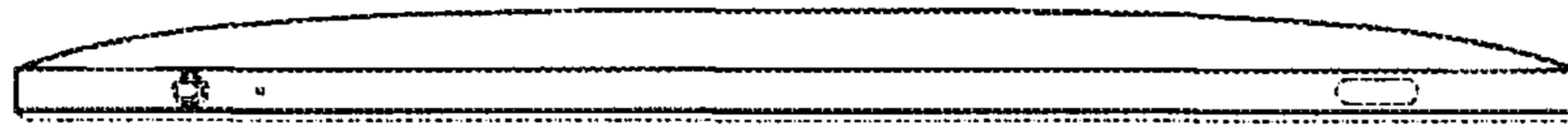


**FIG. 11**

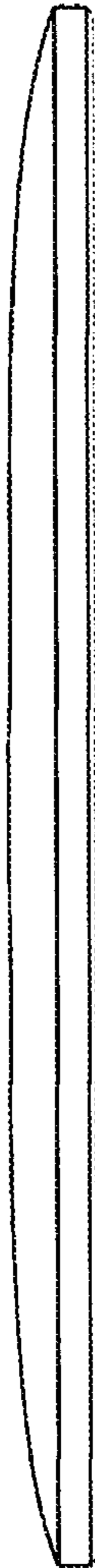


**FIG. 12**

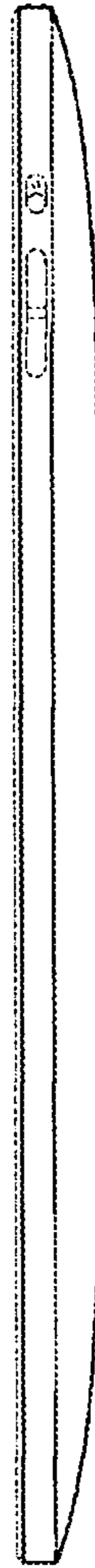




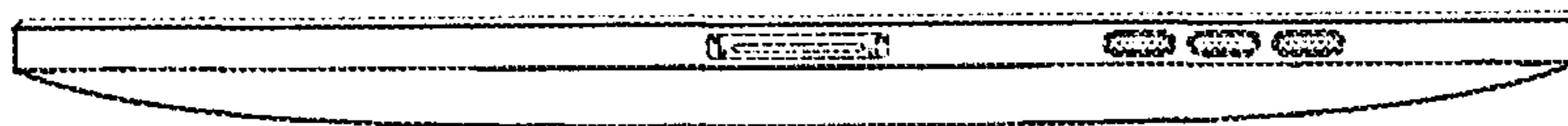
**FIG. 15**



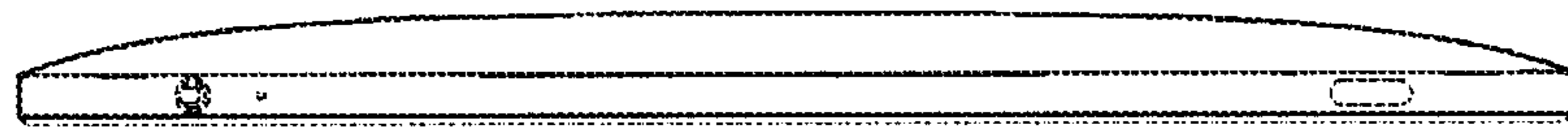
**FIG. 16**



**FIG. 17**



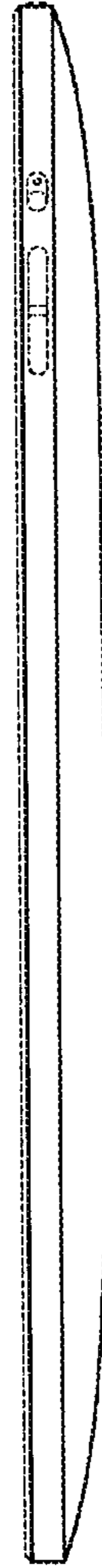
**FIG. 18**



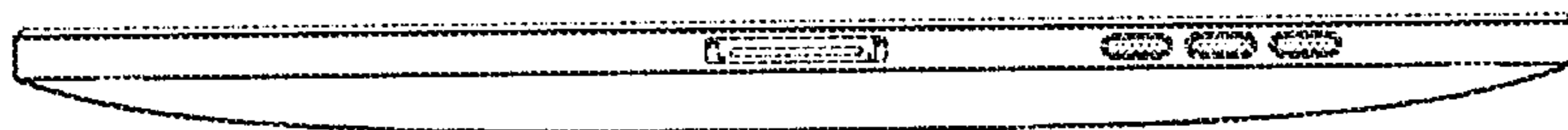
**FIG. 21**



**FIG. 22**



**FIG. 23**



**FIG. 24**