



US00D683726S

(12) **United States Design Patent**
Morisawa

(10) **Patent No.:** **US D683,726 S**
(45) **Date of Patent:** **** Jun. 4, 2013**

(54) **COMPUTER**

(75) Inventor: **Yujin Morisawa**, Tokyo (JP)

(73) Assignee: **Sony Corporation**, Tokyo (JP)

(**) Term: **14 Years**

(21) Appl. No.: **29/371,898**

(22) Filed: **Jan. 6, 2012**

(51) **LOC (9) Cl.** **14-02**

(52) **U.S. Cl.**
USPC **D14/315**

(58) **Field of Classification Search**
USPC ... D14/315-327; D18/1, 2, 7, 11; 235/145 A,
235/145 R; 341/22, 23; 345/104, 156, 168,
345/169, 173; 361/679.08, 679.09, 679.11,
361/679.26, 679.27

See application file for complete search history.

(56) **References Cited**

U.S. PATENT DOCUMENTS

D422,569	S	4/2000	Ogasawara	
6,067,224	A *	5/2000	Nobuchi	361/679.27
D447,740	S *	9/2001	Johansson	D14/138 AA
6,519,139	B2 *	2/2003	Kambayashi	361/679.09
D517,063	S *	3/2006	Nakajima et al.	D14/318
D559,245	S *	1/2008	Iseki	D14/318
D559,246	S	1/2008	Kawase	
D570,344	S	6/2008	Isonaga	
D574,382	S *	8/2008	Tsukahara	D14/432
D577,013	S *	9/2008	Harris et al.	D14/317
D578,125	S *	10/2008	Iseki	D14/432
D581,410	S *	11/2008	Kumano	D14/318
D620,002	S *	7/2010	Tsai et al.	D14/315
D624,911	S *	10/2010	Lee et al.	D14/315
2005/0018396	A1 *	1/2005	Nakajima et al.	361/683
2005/0041378	A1 *	2/2005	Hamada et al.	361/680

FOREIGN PATENT DOCUMENTS

JP	D1257200	S	12/2005
JP	D1369717	S	9/2009

* cited by examiner

Primary Examiner — Freda S Nunn

(74) *Attorney, Agent, or Firm* — Rader, Fishman & Grauer PLLC

(57) **CLAIM**

The ornamental design for a computer, as shown and described.

DESCRIPTION

FIG. 1 is a front, top, right perspective view of a computer showing my new design;
 FIG. 2 is a rear, top, right perspective view thereof;
 FIG. 3 is a front elevational view thereof;
 FIG. 4 is a rear elevational view thereof;
 FIG. 5 is a left side elevational view thereof;
 FIG. 6 is a right side elevational view thereof;
 FIG. 7 is a top plan view thereof; and
 FIG. 8 is a bottom plan view thereof.
 FIG. 9 is a front, top, right perspective view of the computer of FIG. 1 wherein the screen portion is in the closed position;
 FIG. 10 is a rear, top, right perspective view thereof;
 FIG. 11 is a front elevational view thereof;
 FIG. 12 is a left side elevational view thereof; and
 FIG. 13 is a right side elevational view thereof.
 FIG. 14 is a top plan view thereof; and
 FIG. 15 is a bottom plan view thereof.
 FIG. 16 is a front, top, right perspective view of a second embodiment computer showing my new design;
 FIG. 17 is a rear, top, right perspective view thereof;
 FIG. 18 is a front elevational view thereof;
 FIG. 19 is a rear elevational view thereof;
 FIG. 20 is a left side elevational view thereof;
 FIG. 21 is a right side elevational view thereof;
 FIG. 22 is a top plan view thereof; and
 FIG. 23 is a bottom plan view thereof.
 FIG. 24 is a front, top, right perspective view of the computer of FIG. 16 wherein the screen portion is in the closed position;
 FIG. 25 is a rear, top, right perspective view thereof;
 FIG. 26 is a front elevational view thereof;
 FIG. 27 is a left side elevational view thereof;
 FIG. 28 is a right side elevational view thereof; and
 FIG. 29 is a top plan view thereof.
 FIG. 30 is a front, top, right perspective view of a third embodiment computer showing my new design;

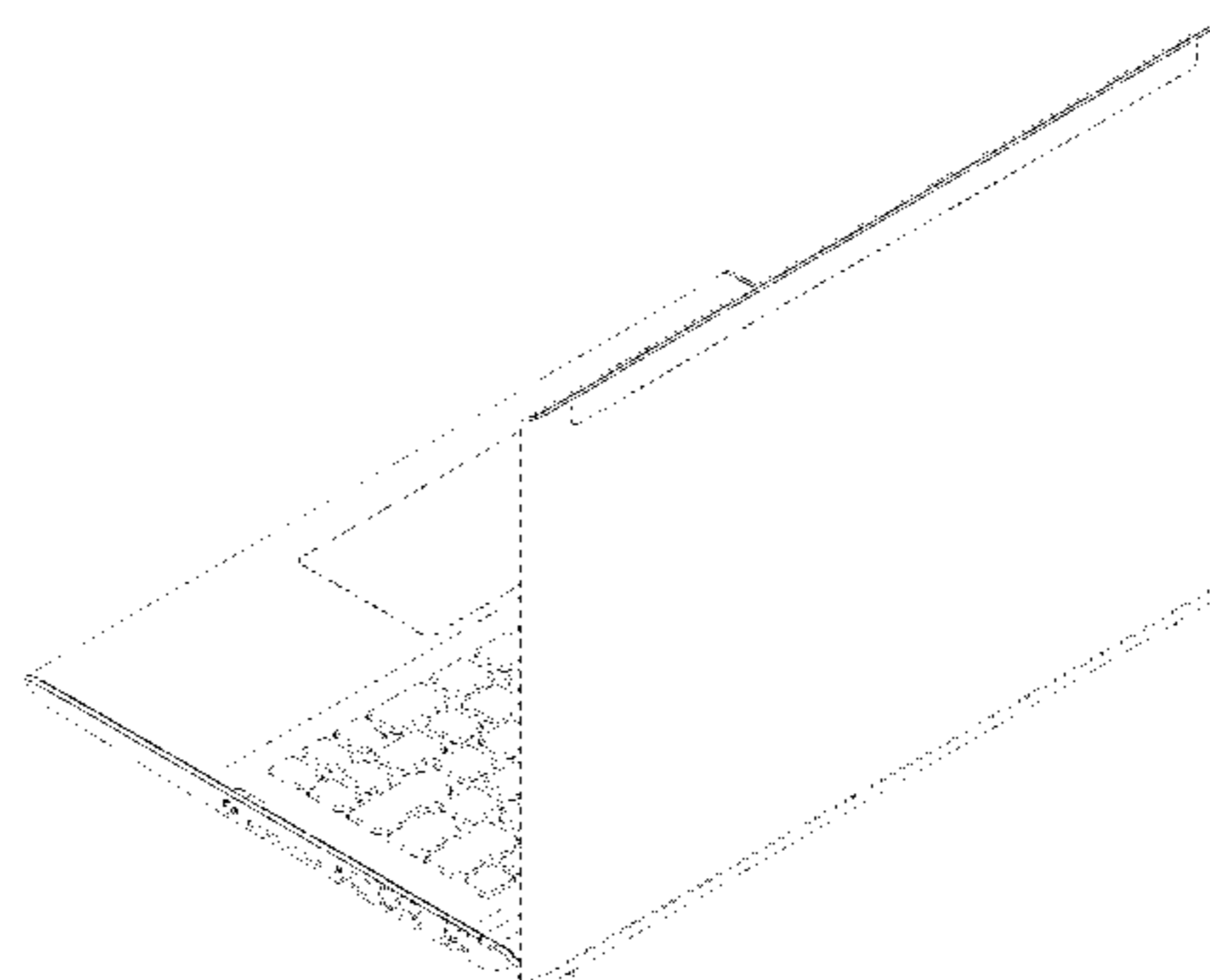
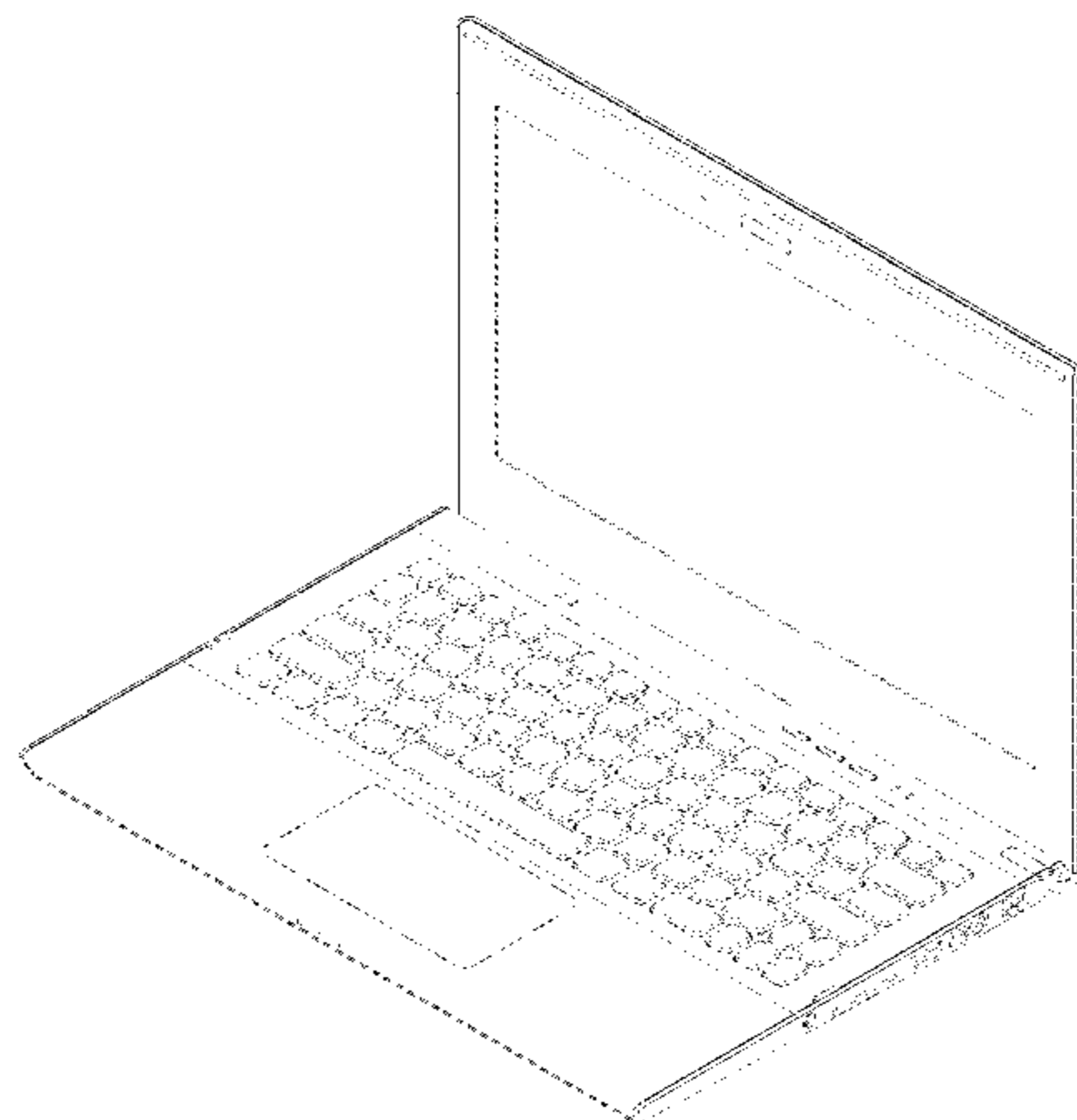

FIG. 31 is a rear, top, right perspective view thereof;
FIG. 32 is front elevational view thereof;
FIG. 33 is a rear elevational view thereof;
FIG. 34 is a left side elevational view thereof;
FIG. 35 is a right side elevational view thereof;
FIG. 36 is a top plan view thereof; and
FIG. 37 is a bottom plan view thereof.
FIG. 38 is a front, top, right perspective view of the computer of FIG. 30 wherein the screen portion is in the closed position;
FIG. 39 is a rear, top, right perspective view thereof;
FIG. 40 is a front elevational view thereof;
FIG. 41 is a left side elevational view thereof;
FIG. 42 is a right side elevational view thereof;
FIG. 43 is a top plan view thereof; and
FIG. 44 is a bottom plan view thereof.
FIG. 45 is a front, top, right perspective view of a fourth embodiment computer showing my new design;
FIG. 46 is a rear, top, right perspective view thereof;
FIG. 47 is front elevational view thereof;
FIG. 48 is a rear elevational view thereof;
FIG. 49 is a left side elevational view thereof;

FIG. 50 is a right side elevational view thereof;
FIG. 51 is a top plan view thereof; and
FIG. 52 is a bottom plan view thereof.
FIG. 53 is a front, top, right perspective view of the computer of FIG. 45 wherein the screen portion is in the closed position;
FIG. 54 is a rear, top, right perspective view thereof;
FIG. 55 is a front elevational view thereof;
FIG. 56 is a left side elevational view thereof;
FIG. 57 is a right side elevational view thereof;
FIG. 58 is a top plan view thereof; and
FIG. 59 is a bottom plan view thereof.
FIG. 60 is an enlarged front elevational view along the lines 60-60 of FIG. 55; and,
FIG. 61 is an enlarged front elevational view along the line 61-61 of FIG. 55.
Portions shown as broken lines are for illustrative purposes only and form no part of the claimed design. Dot-dash lines define the boundaries of, but not included in, the claimed design.

1 Claim, 52 Drawing Sheets

FIG. 1

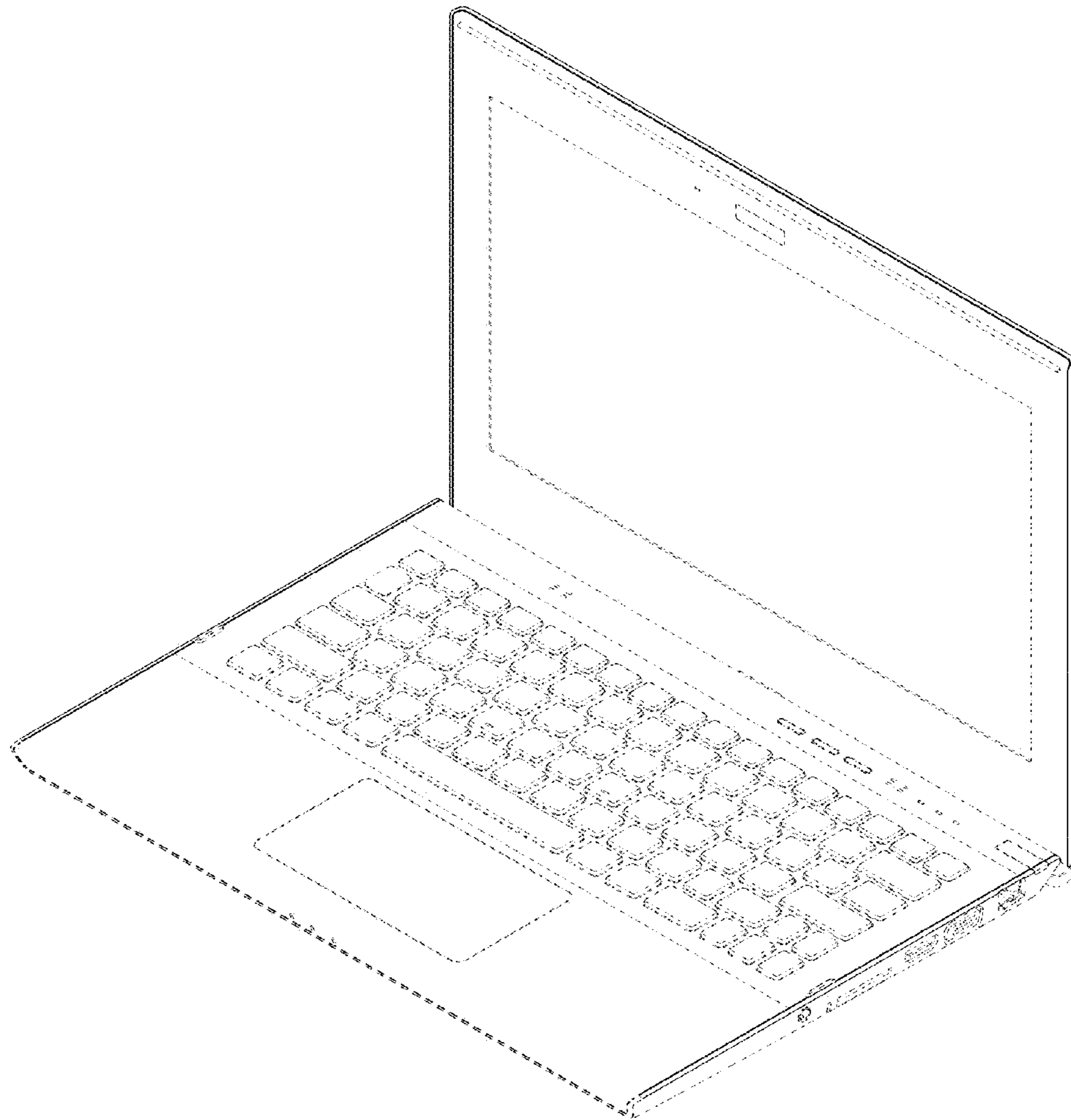

FIG.2

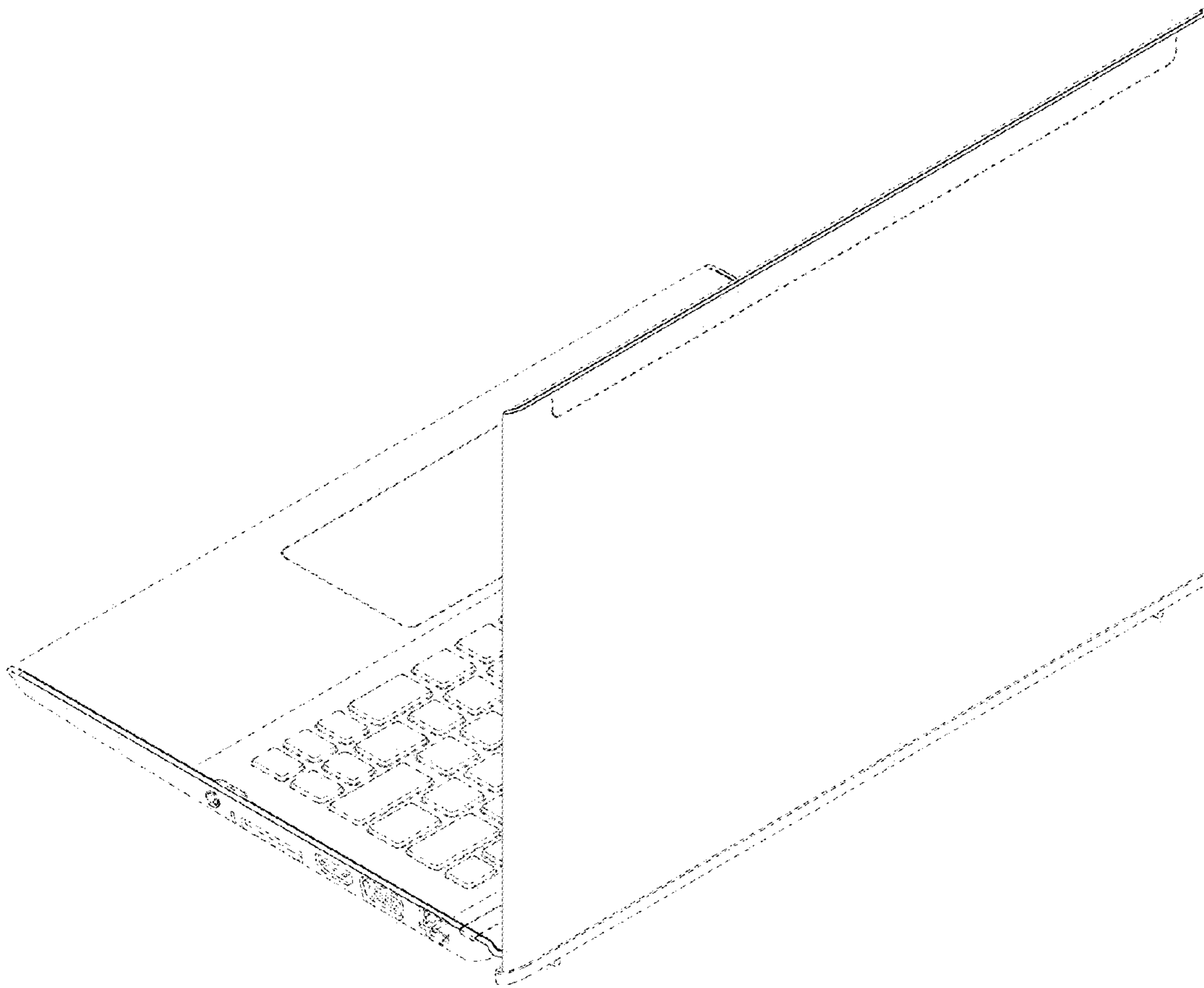

FIG. 3

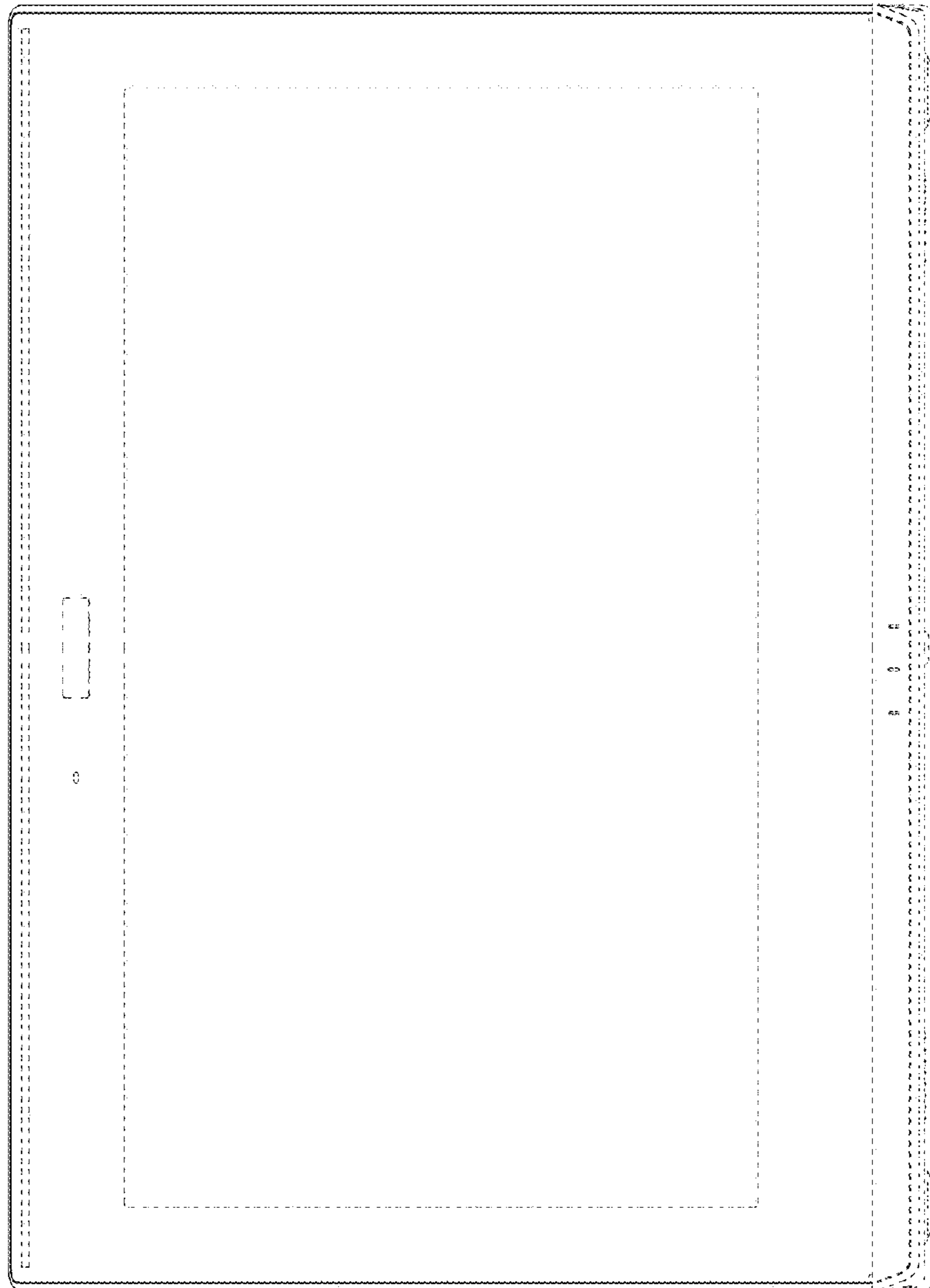

FIG.4

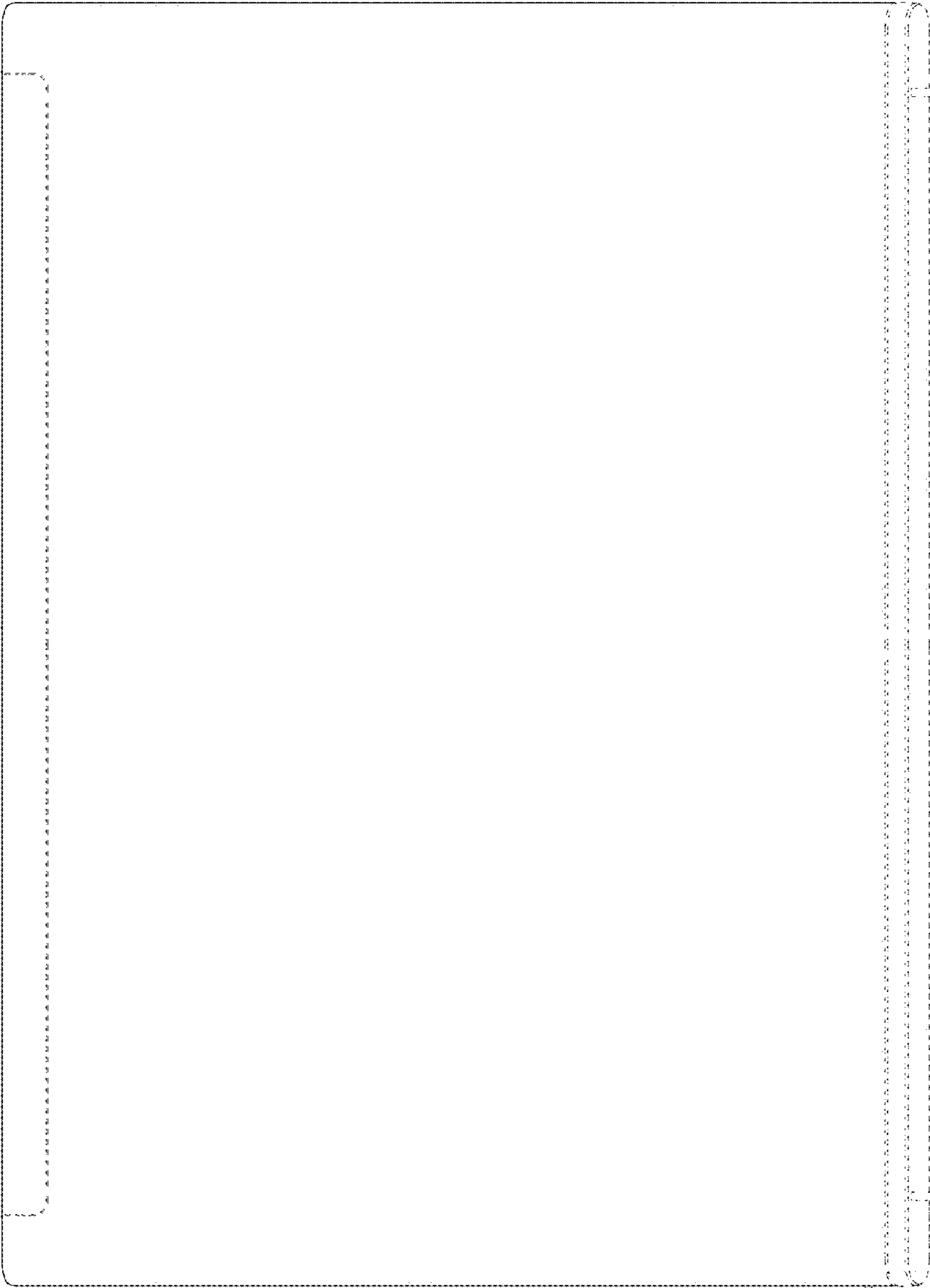

FIG. 5

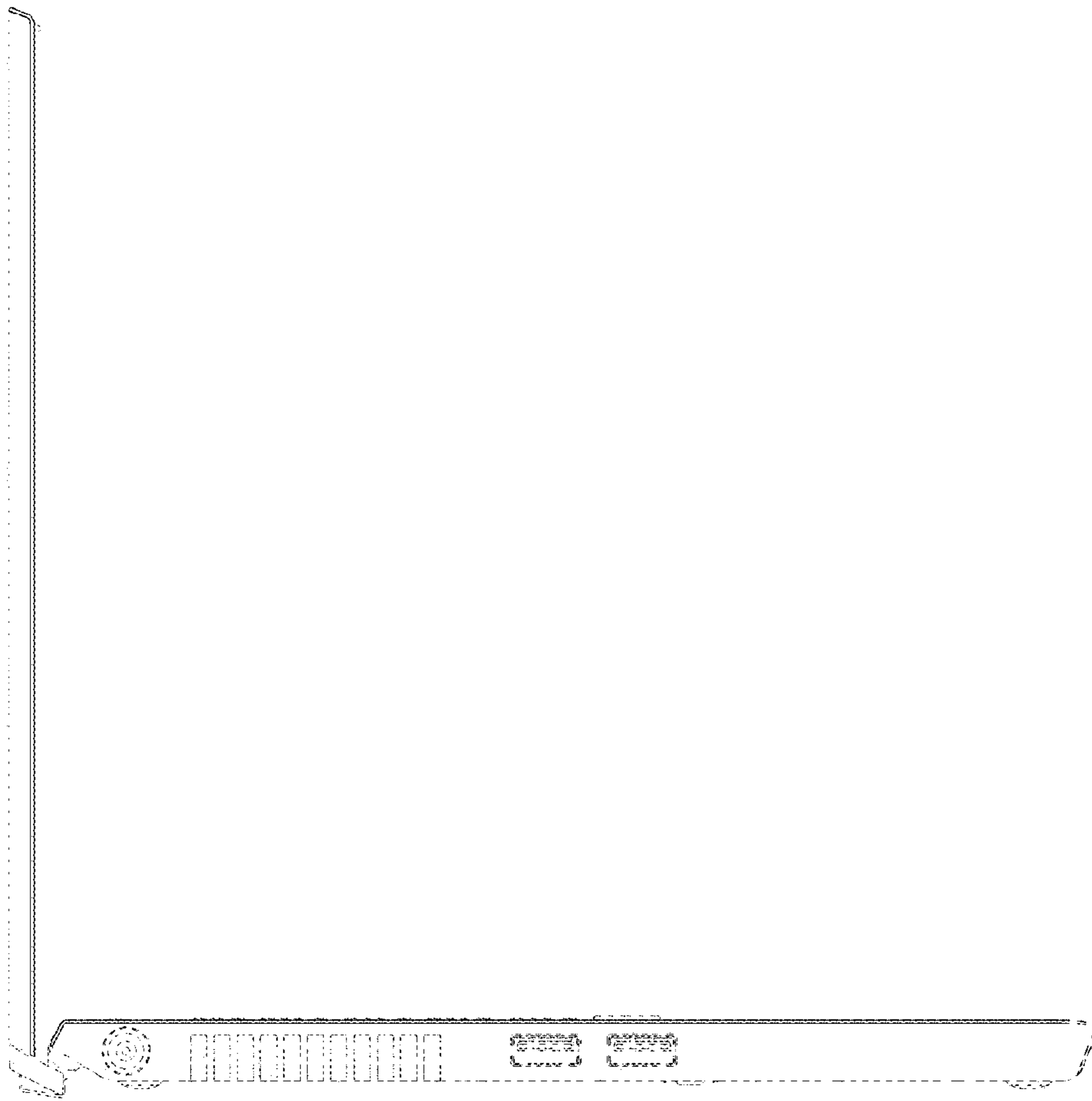

FIG.6

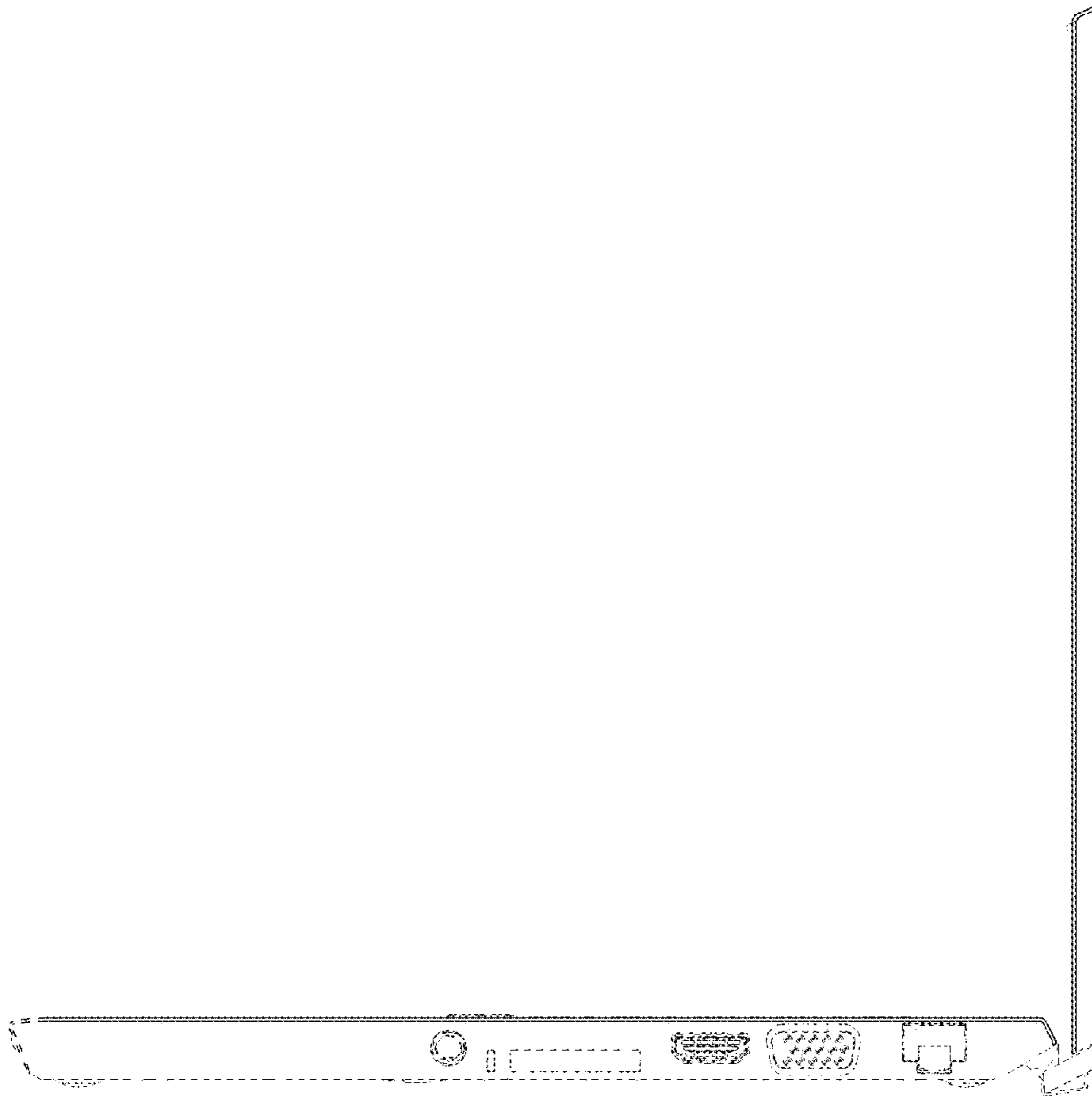

FIG. 7

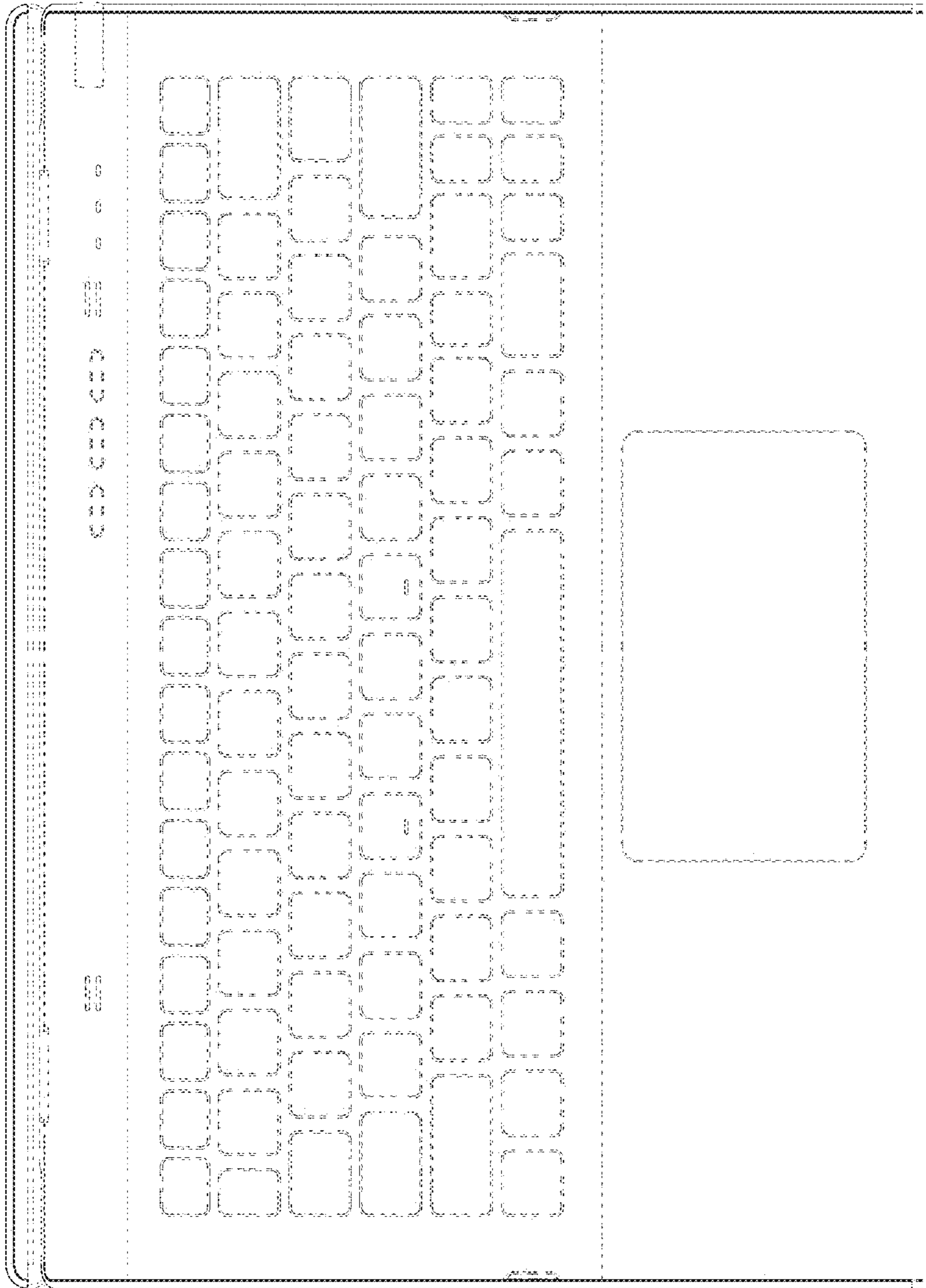

FIG. 8

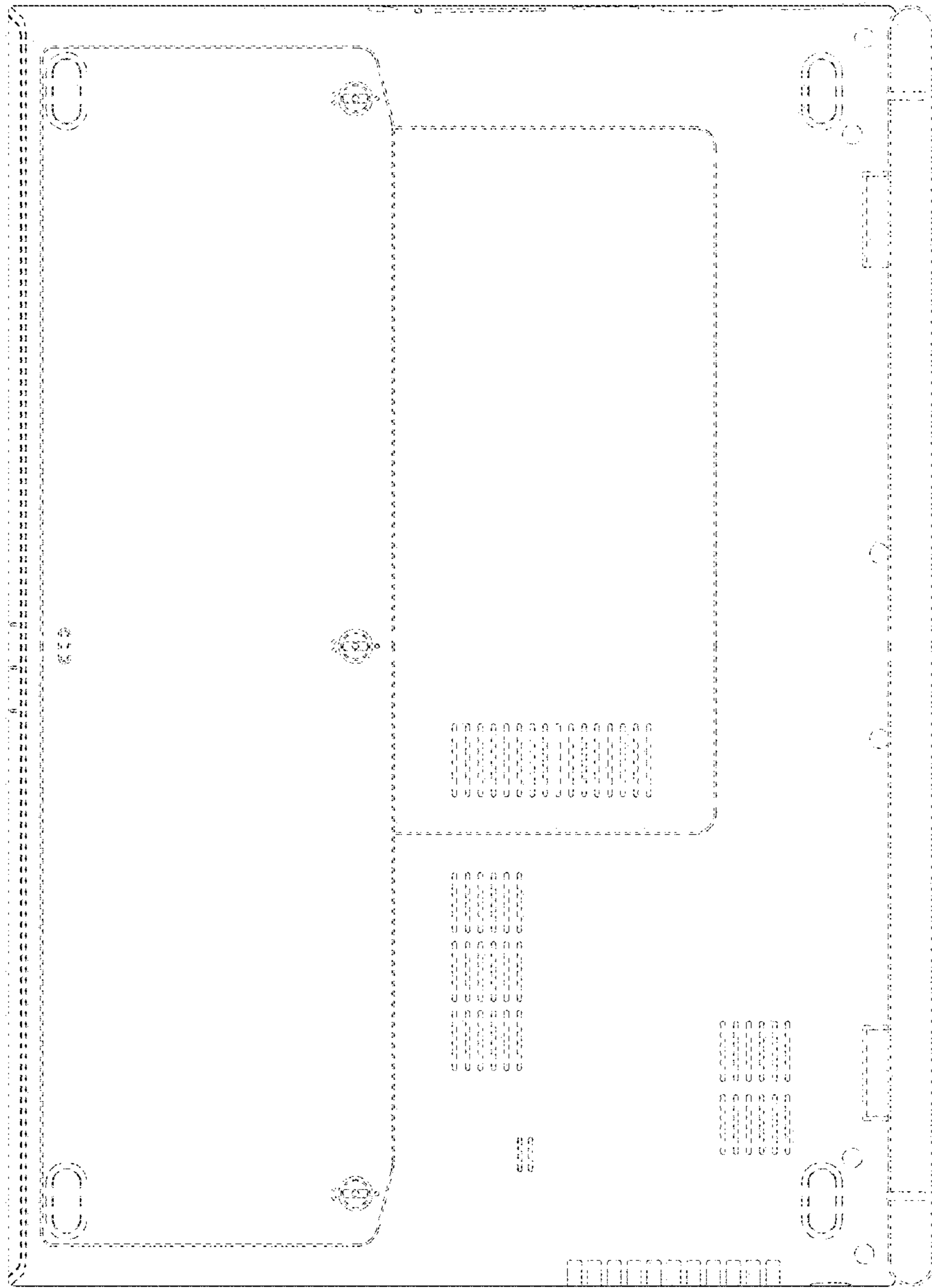

FIG.9

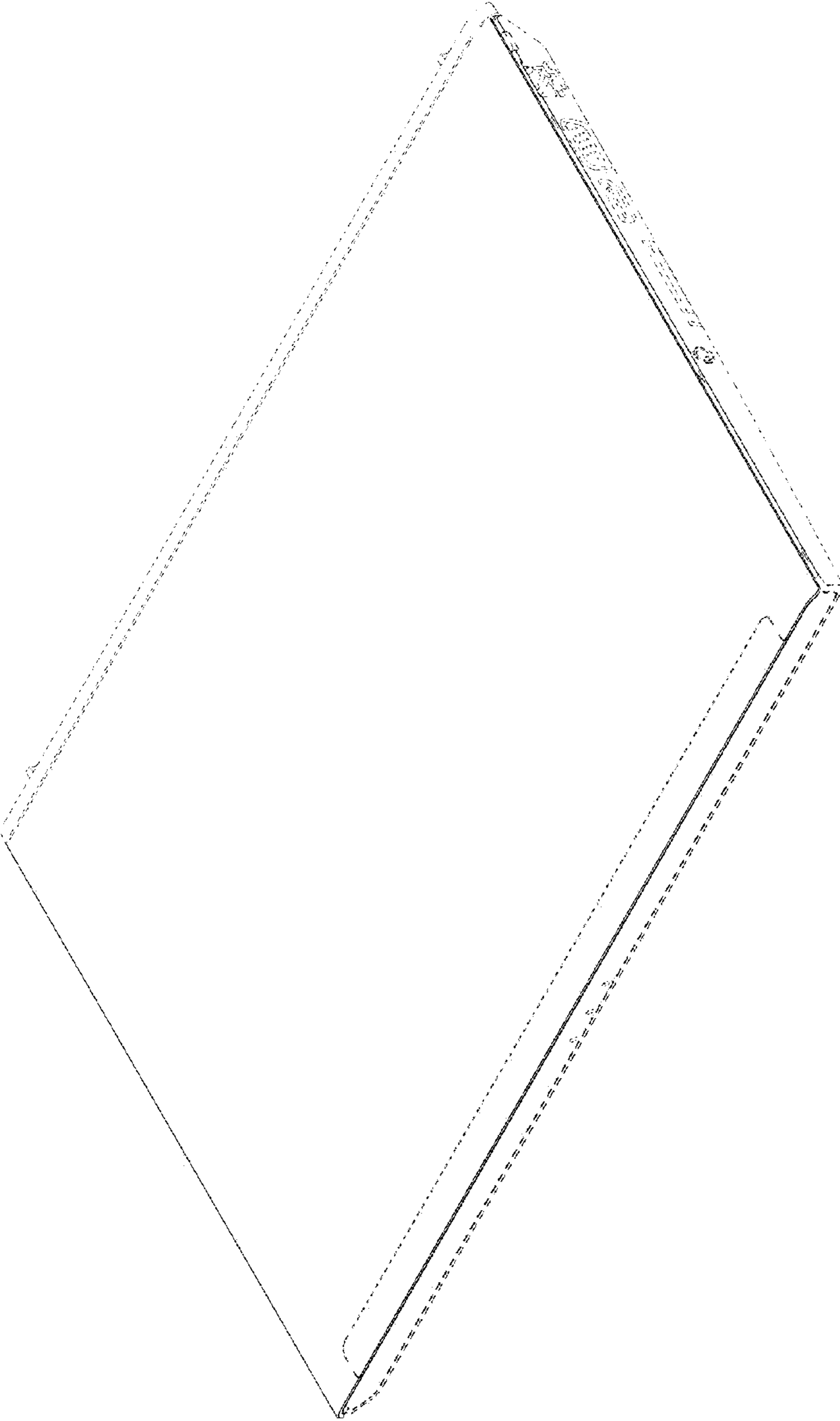

FIG.10

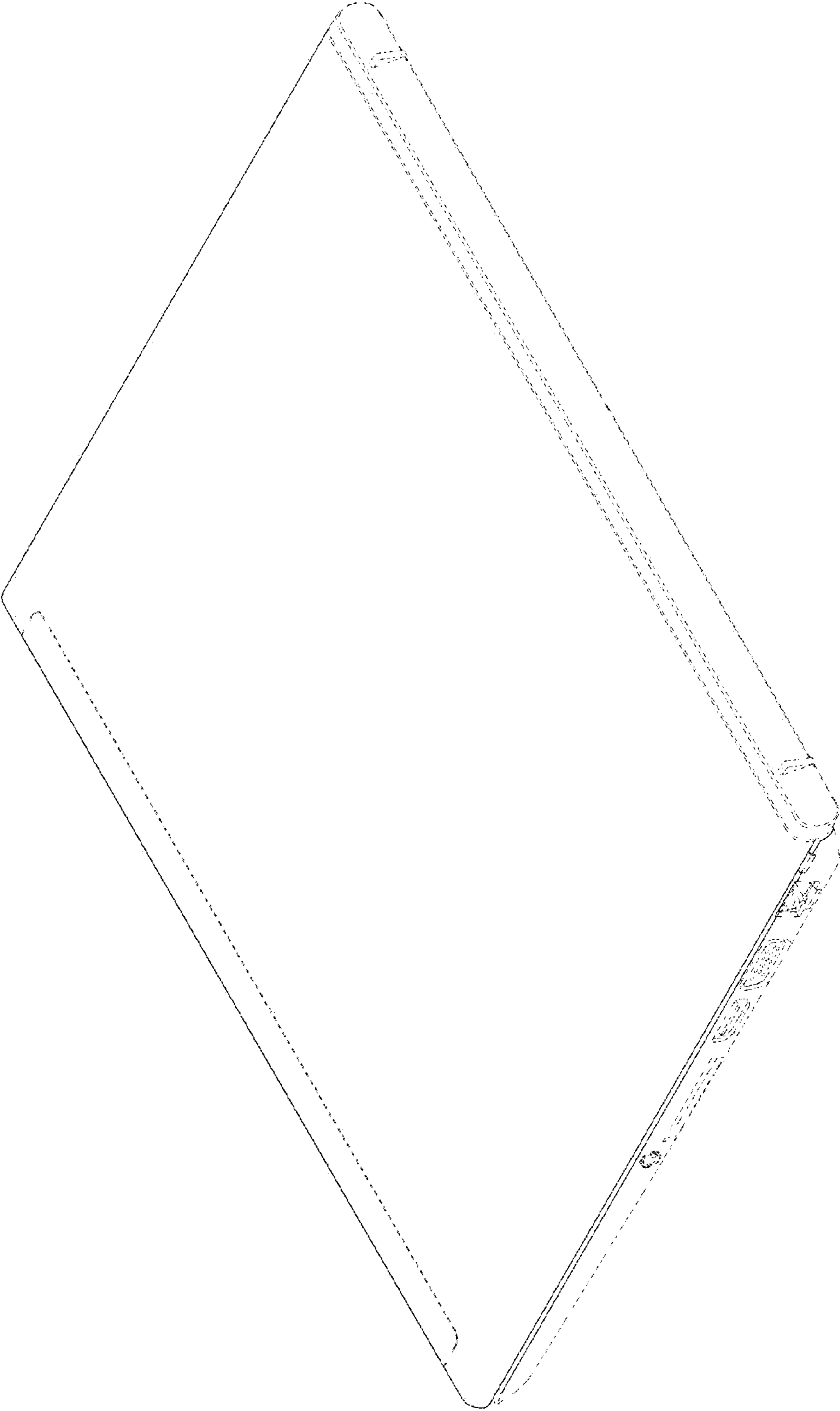

FIG.11

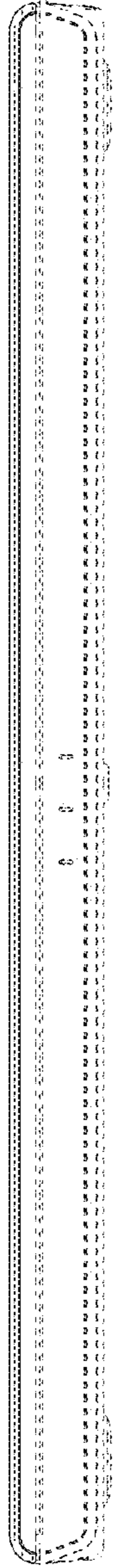

FIG.12

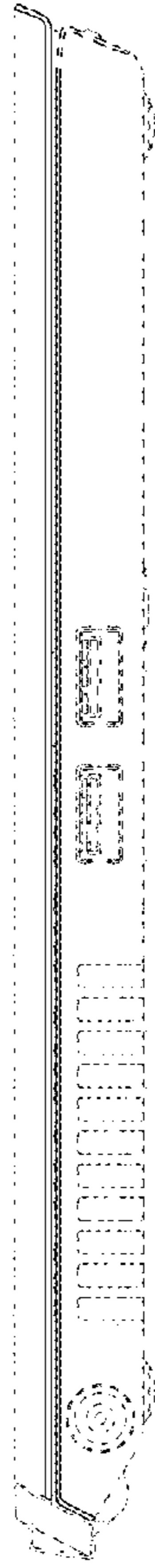

FIG.13

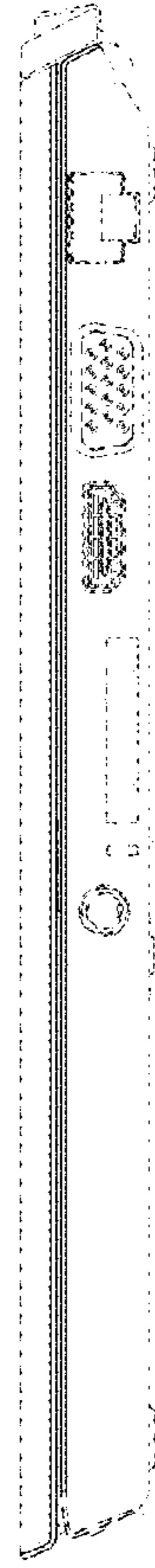

FIG.14

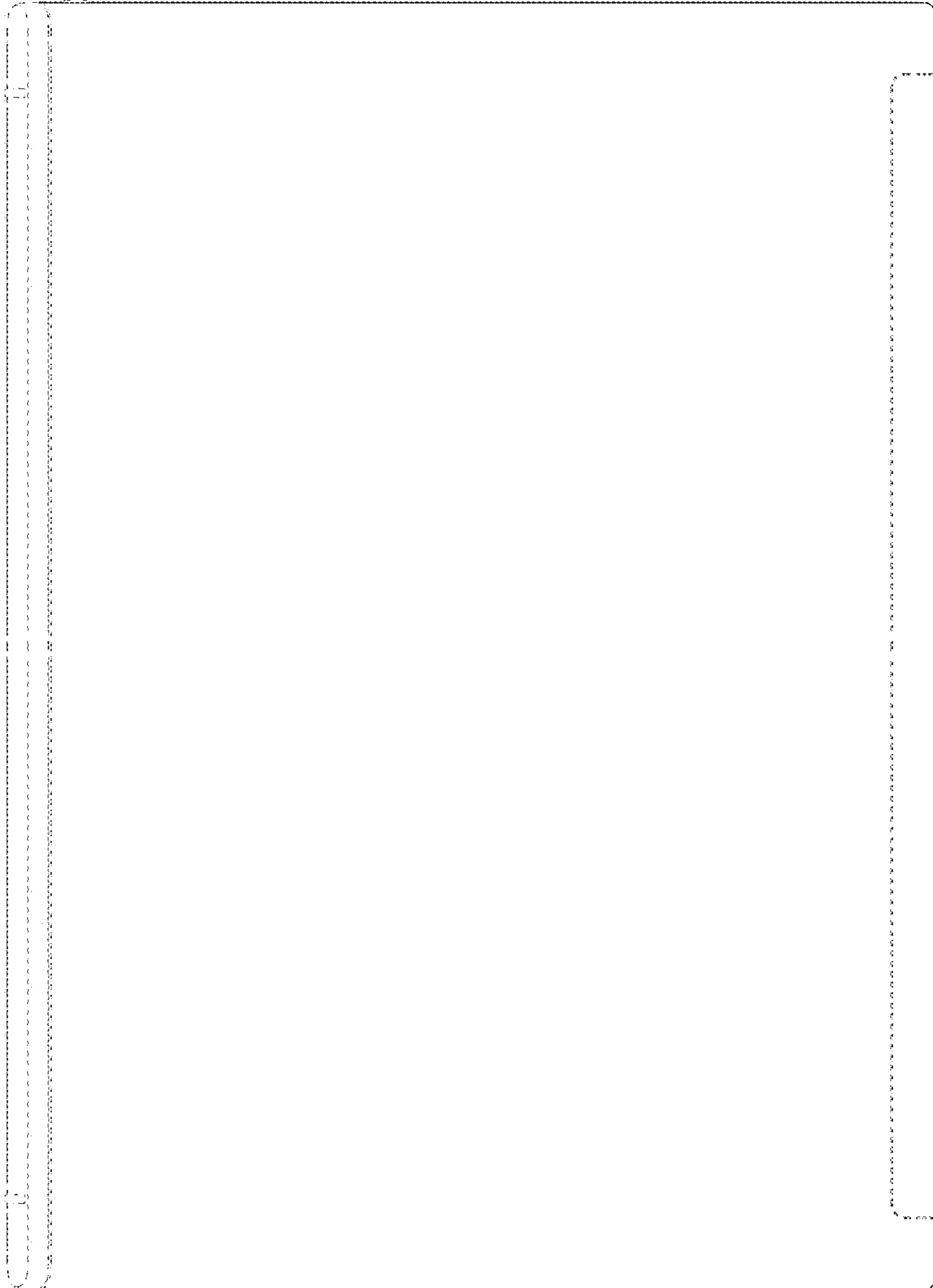

FIG.15

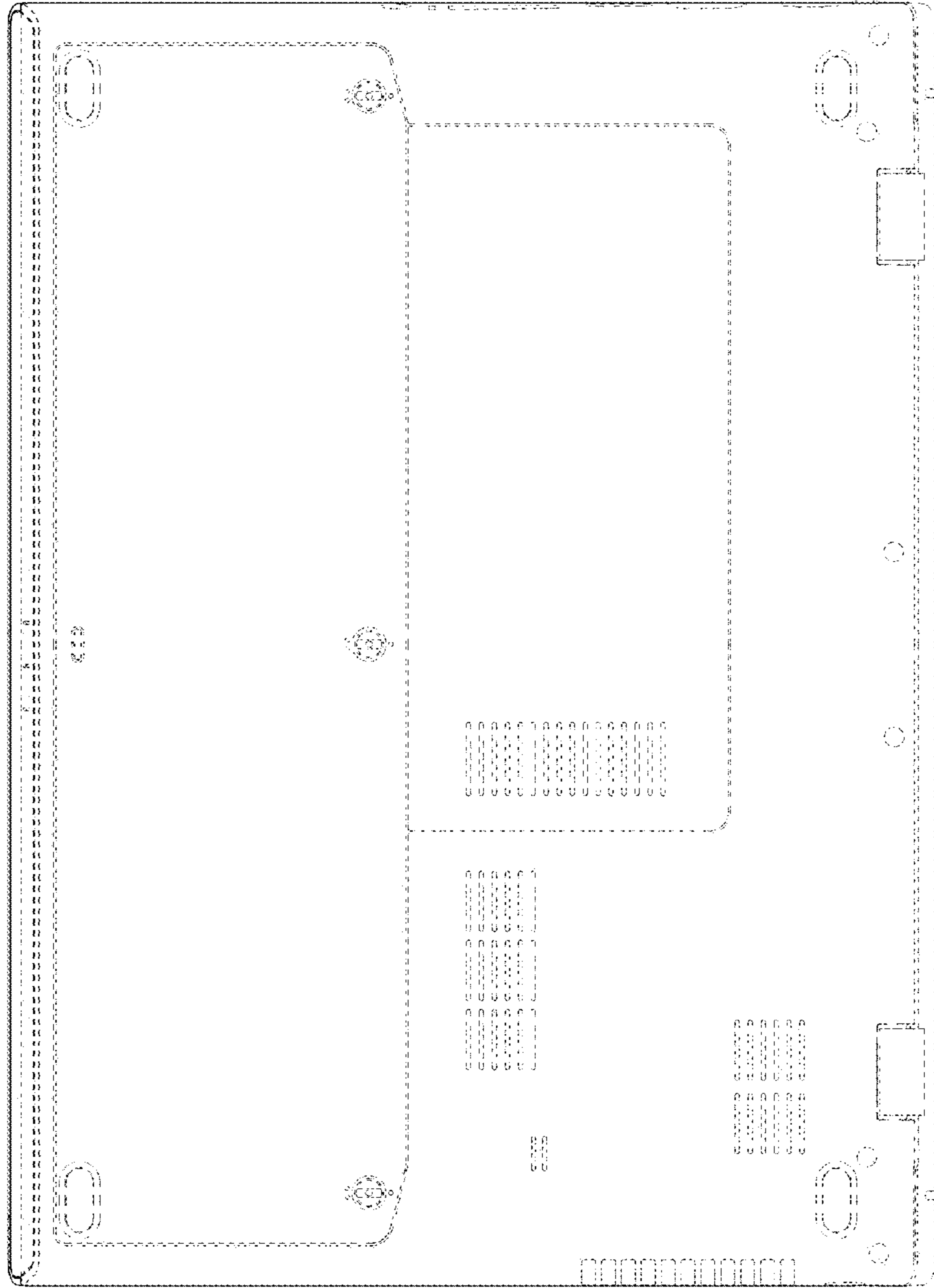

FIG. 16

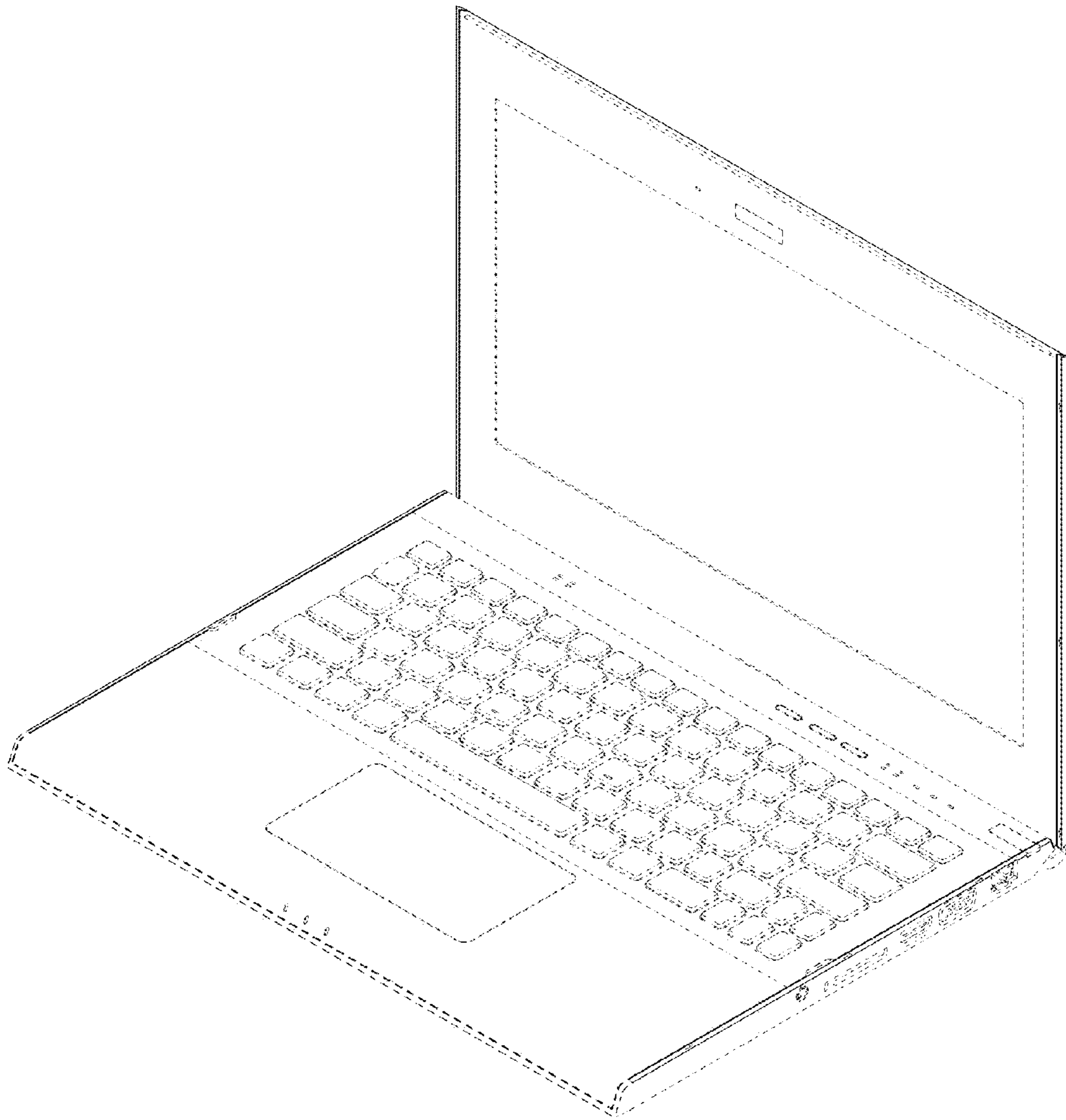

FIG.17

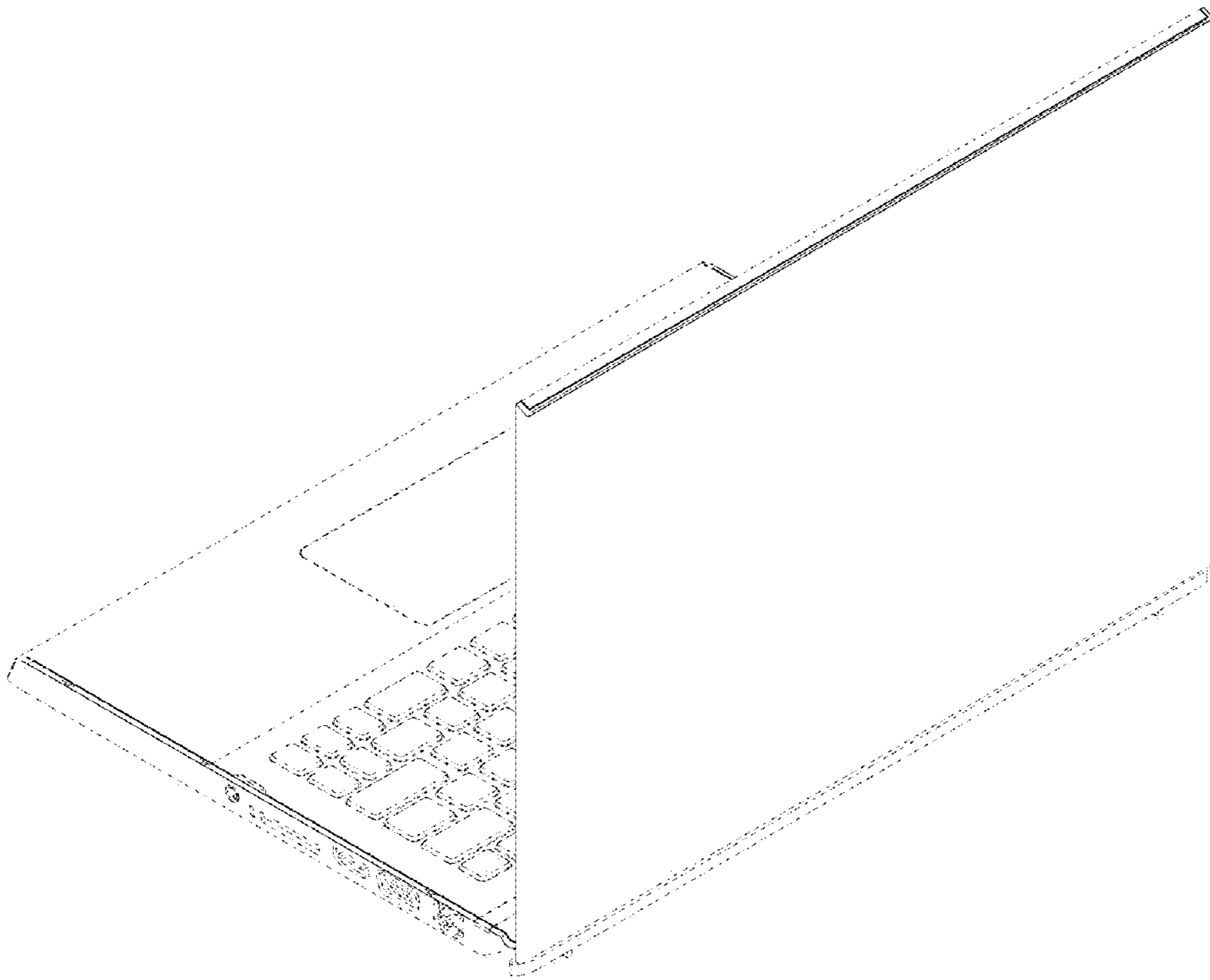

FIG. 18

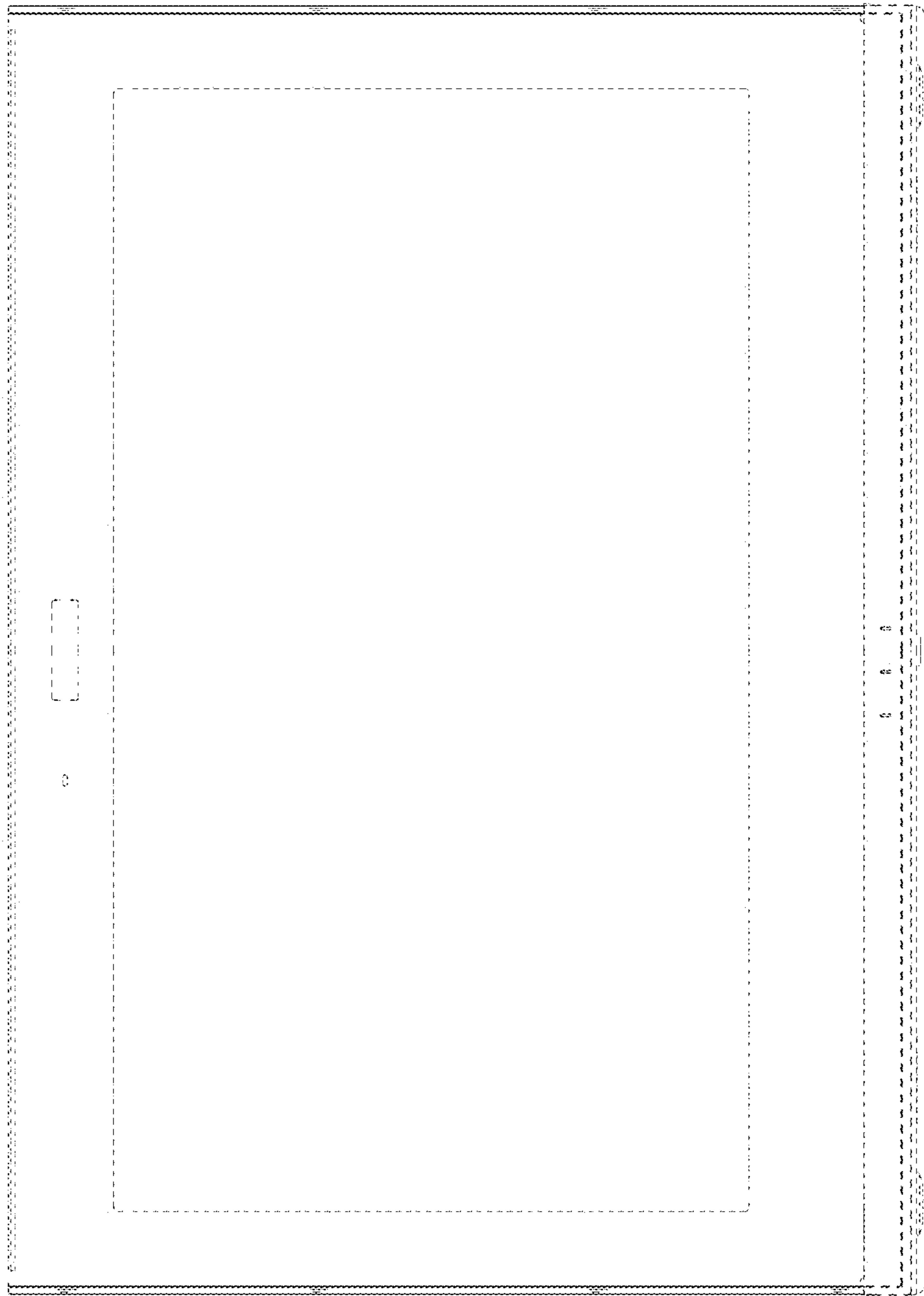

FIG. 19

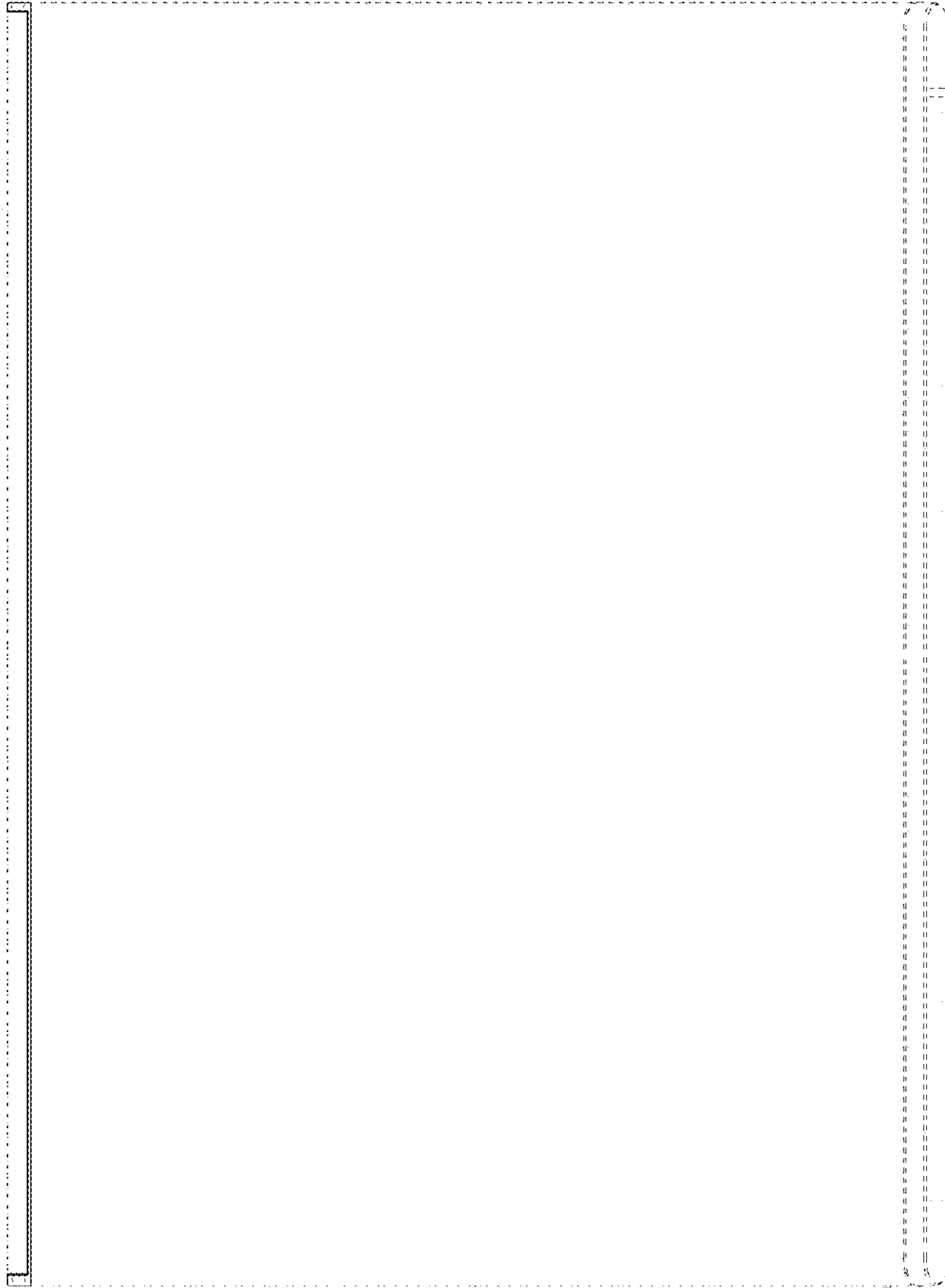

FIG.20

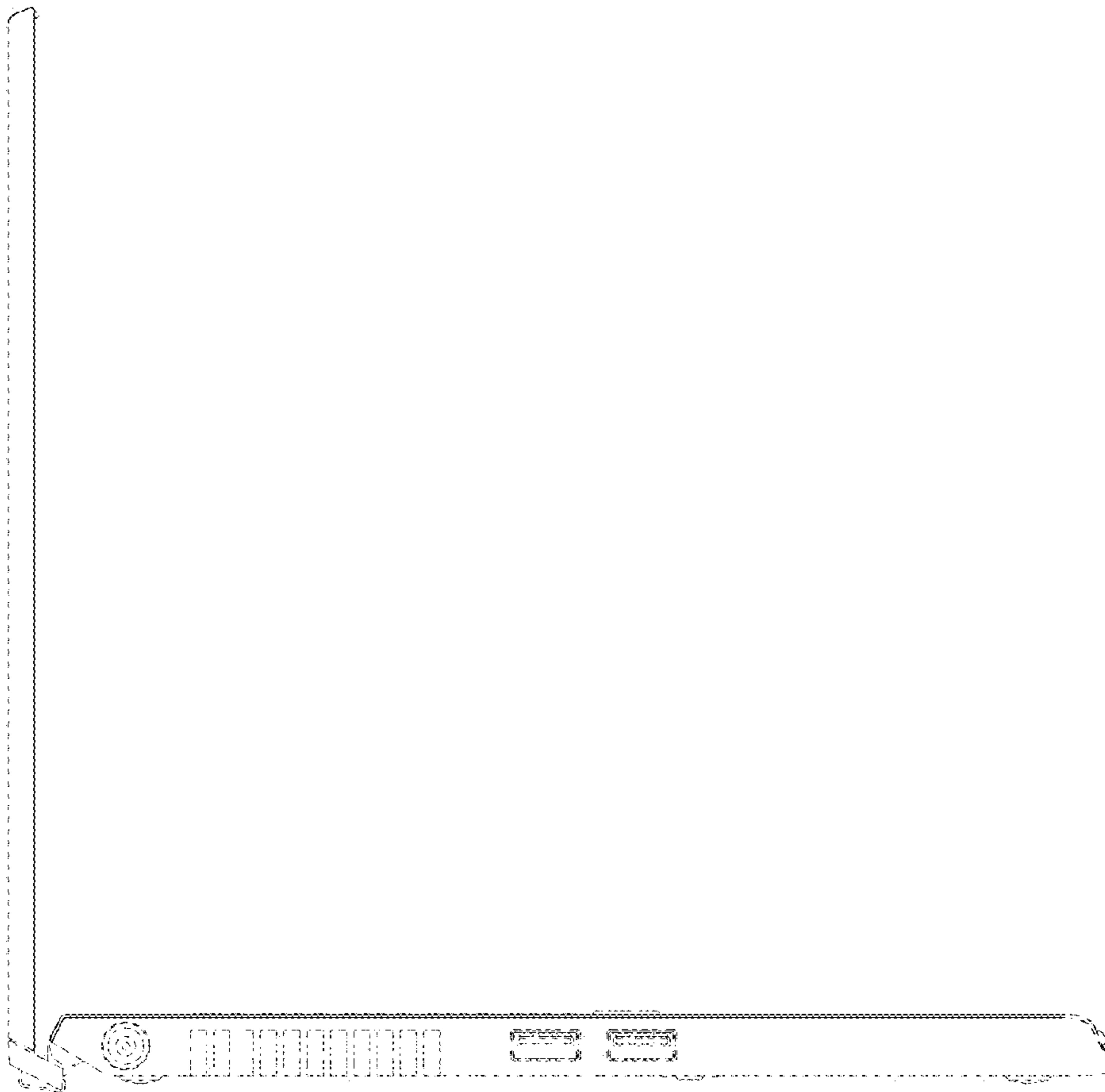

FIG.21

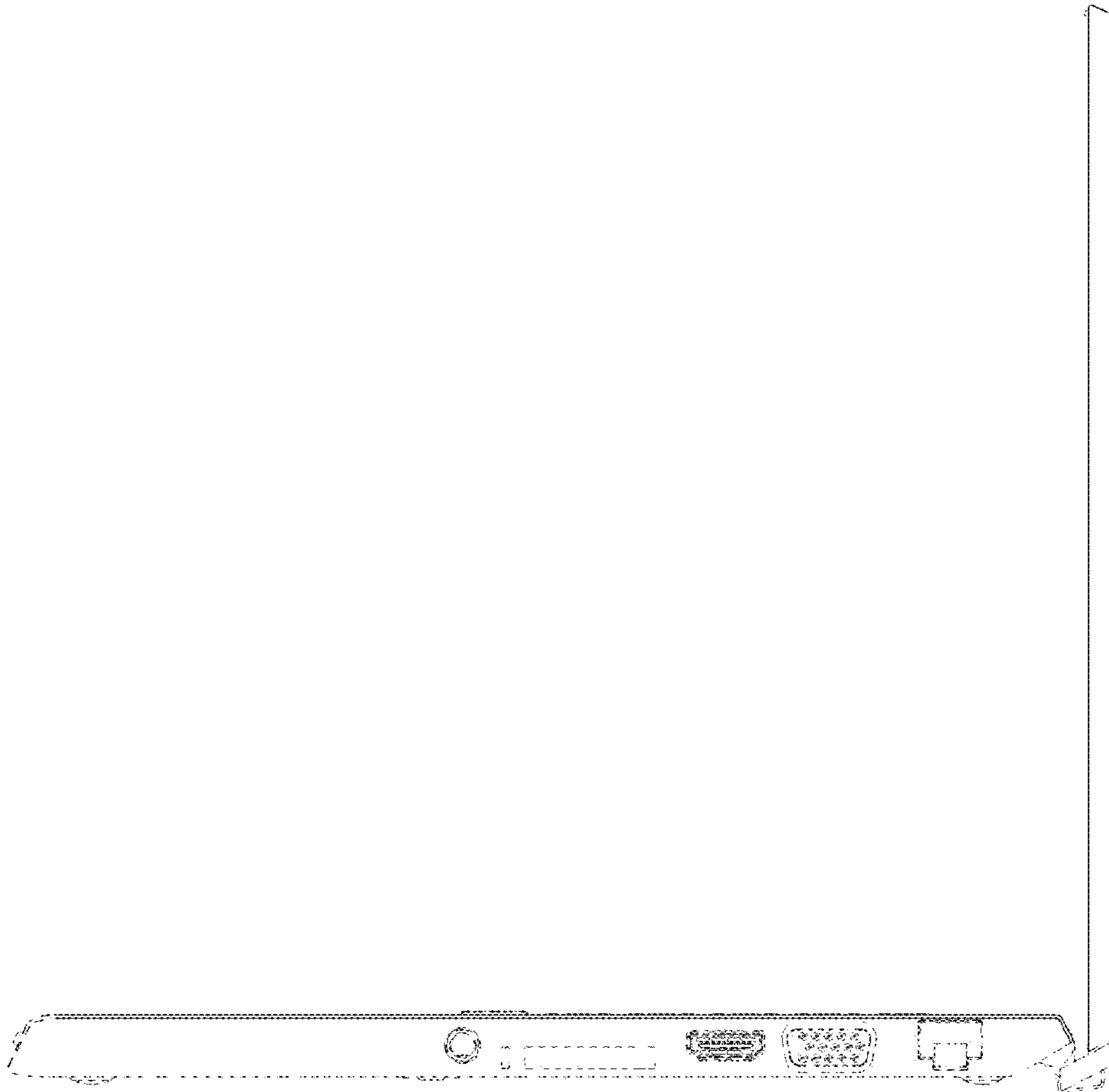

FIG. 22

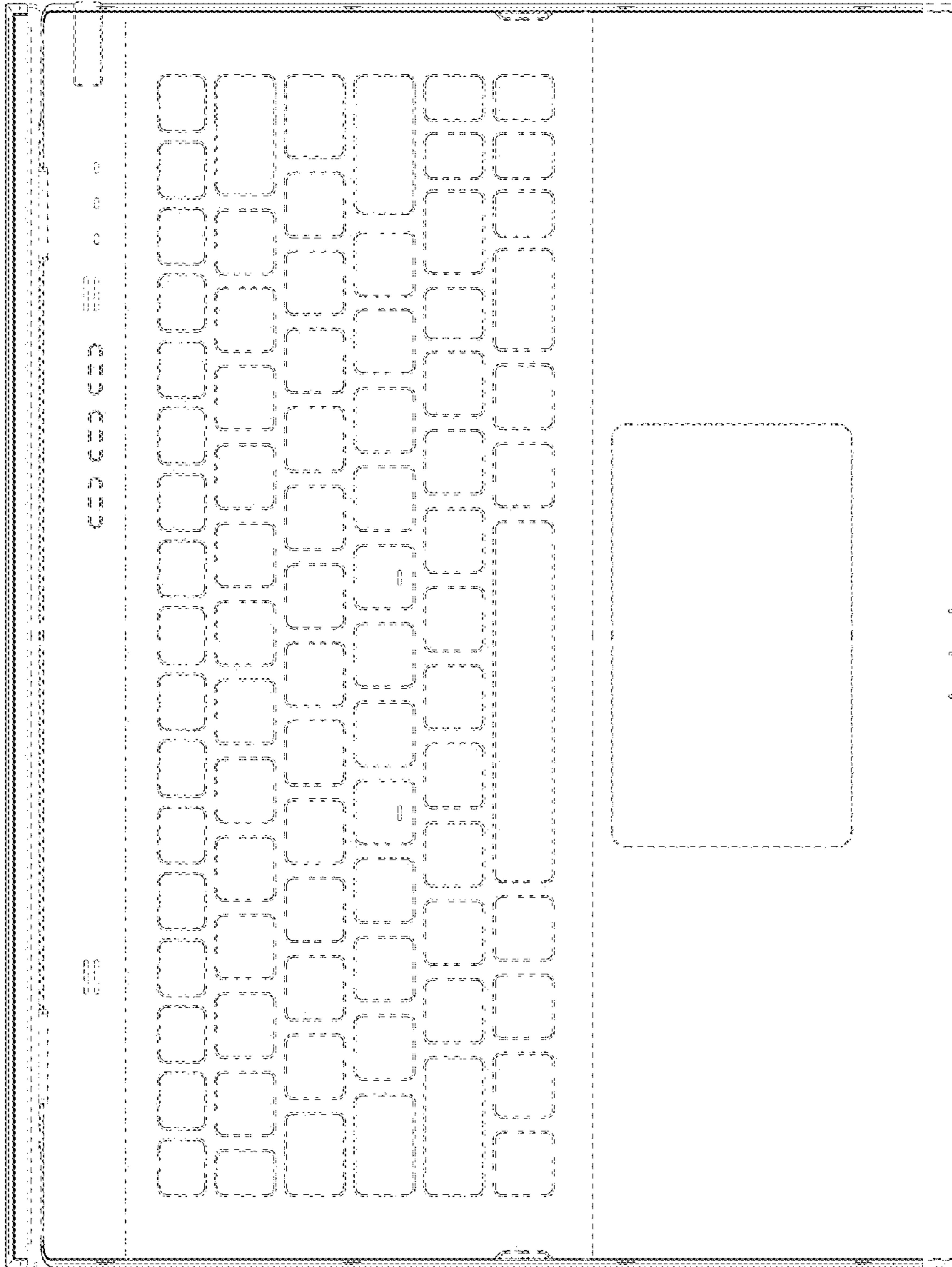

FIG.23

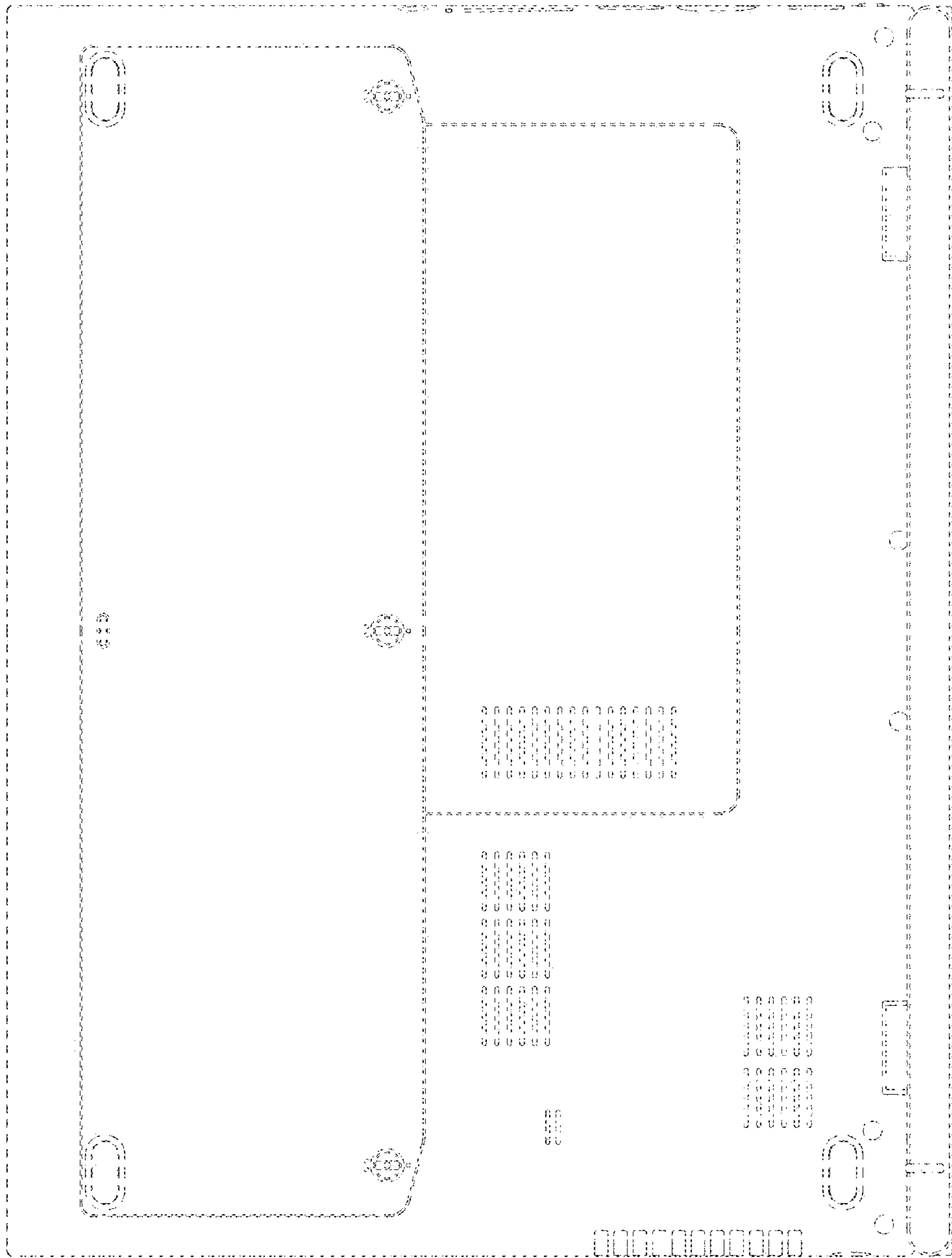

FIG.24

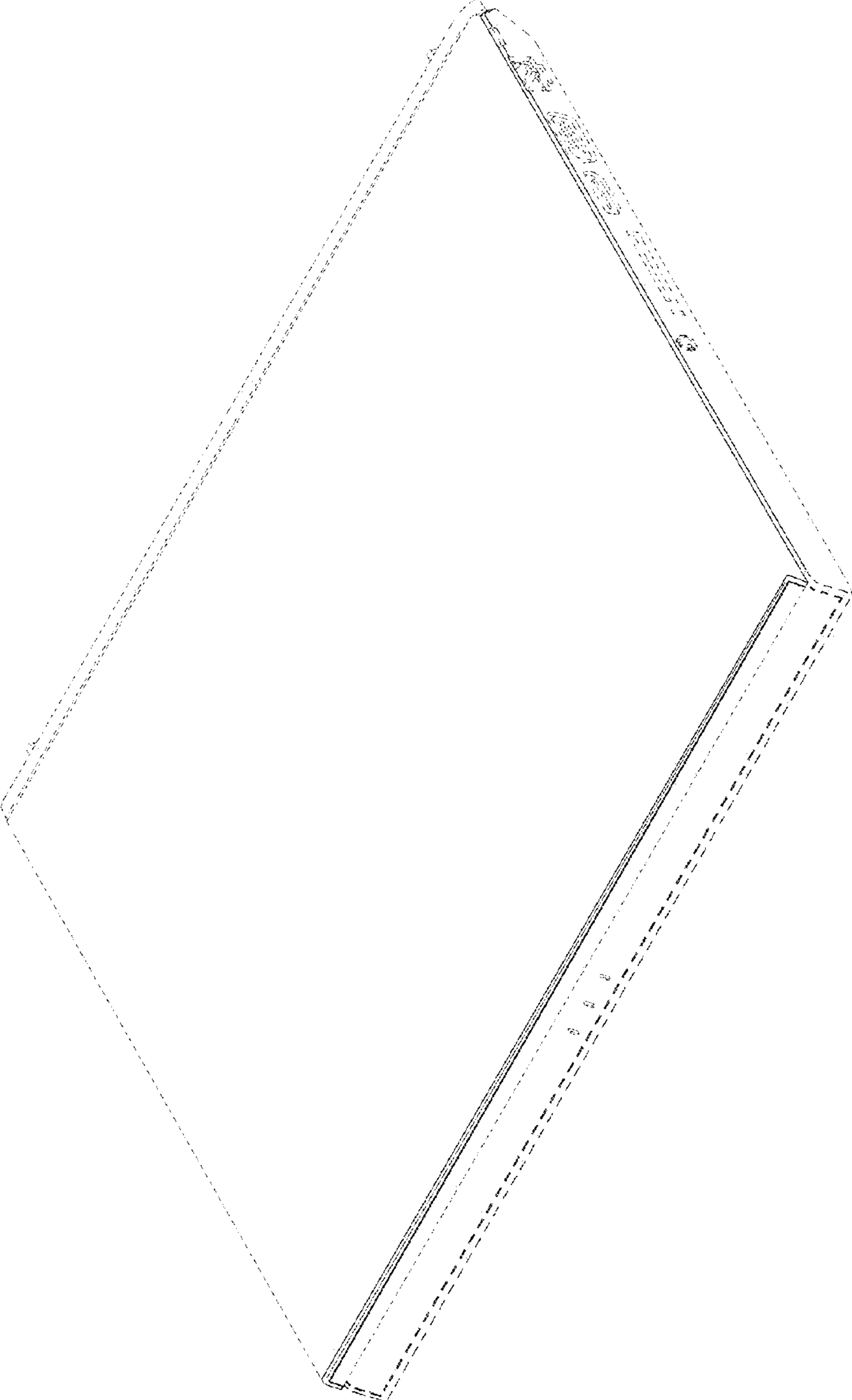

FIG.25

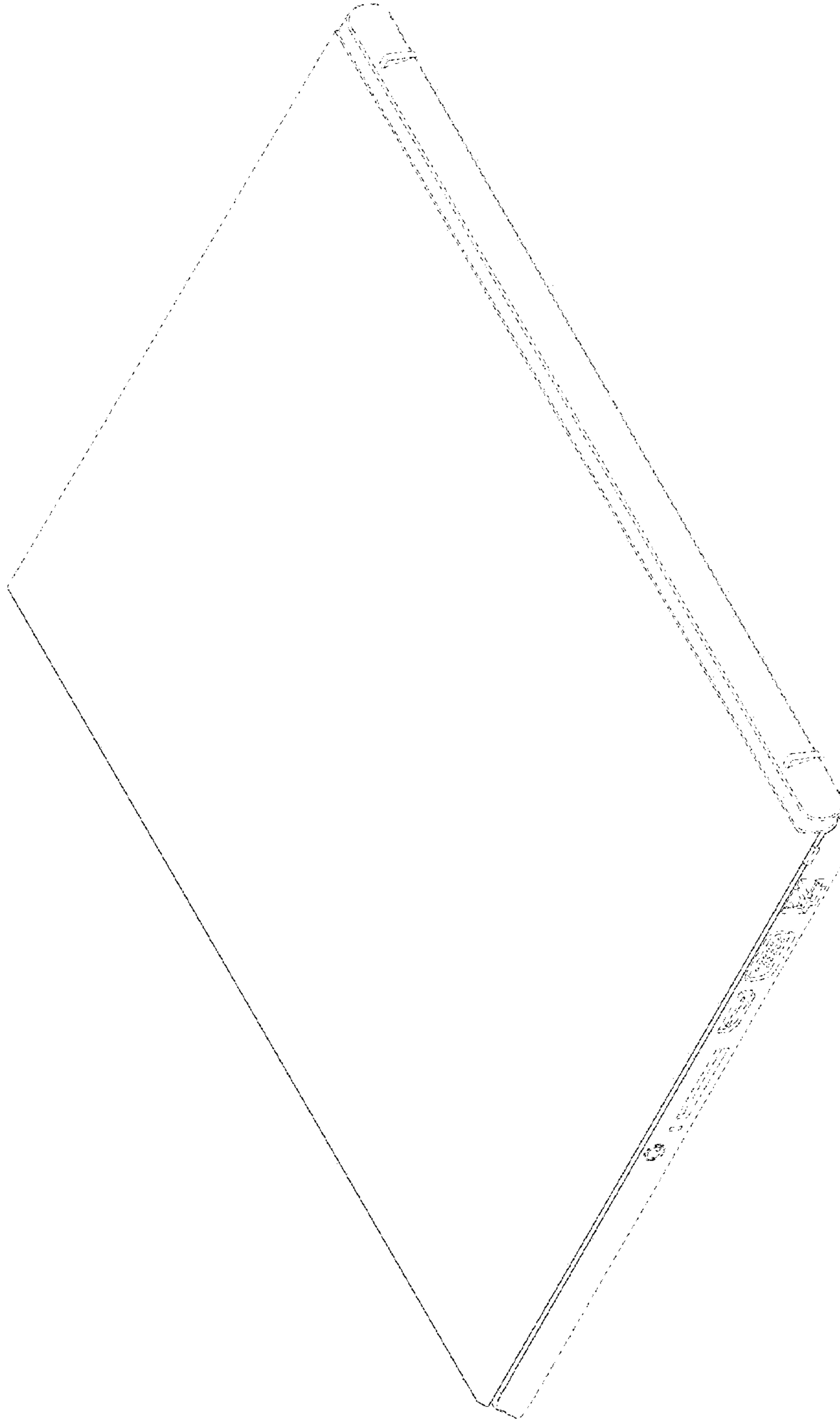

FIG.26



FIG.27



FIG.28

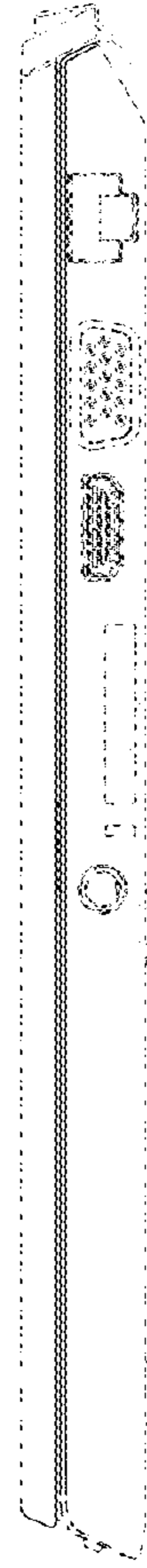

FIG. 29

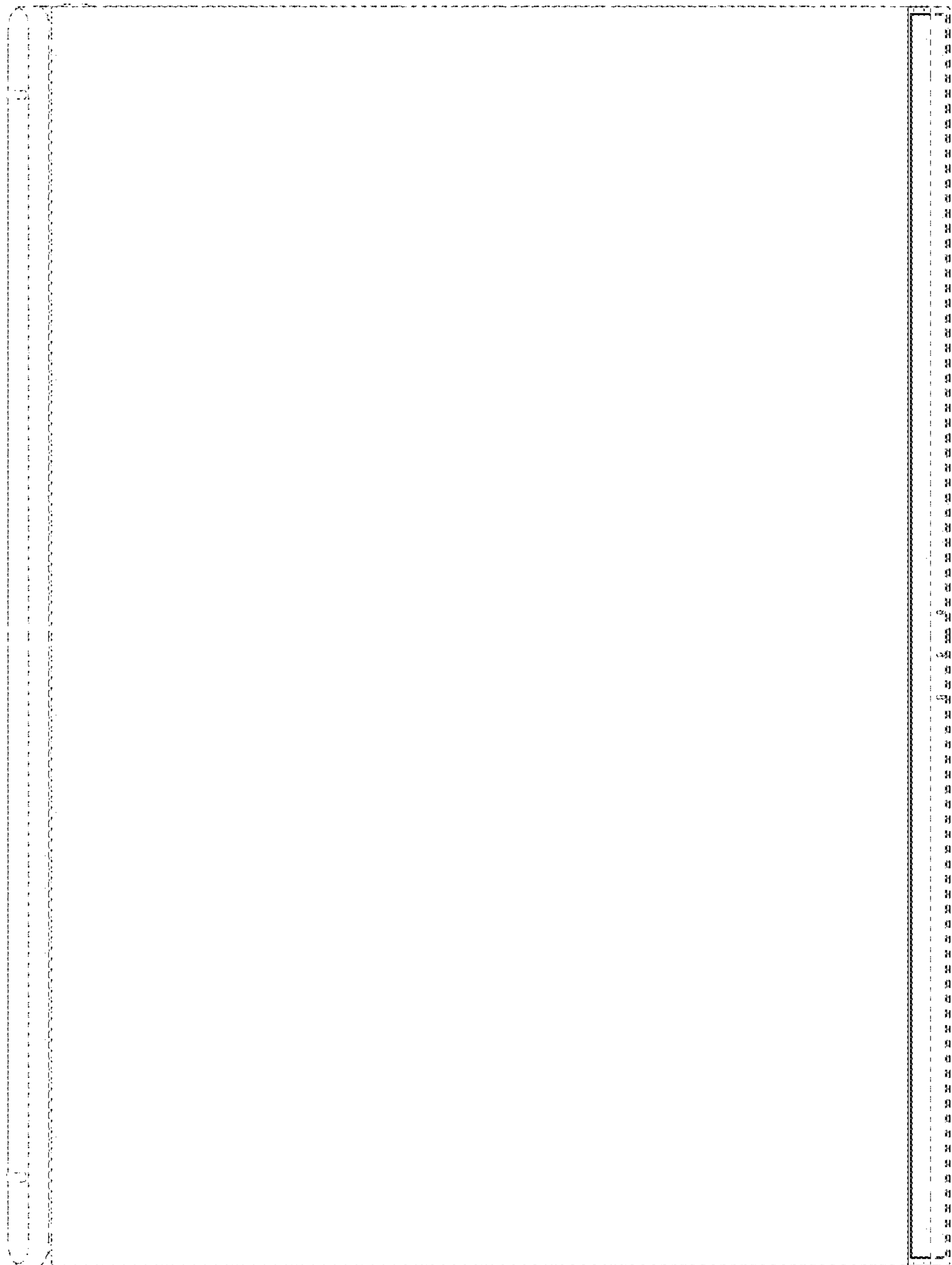

FIG.30

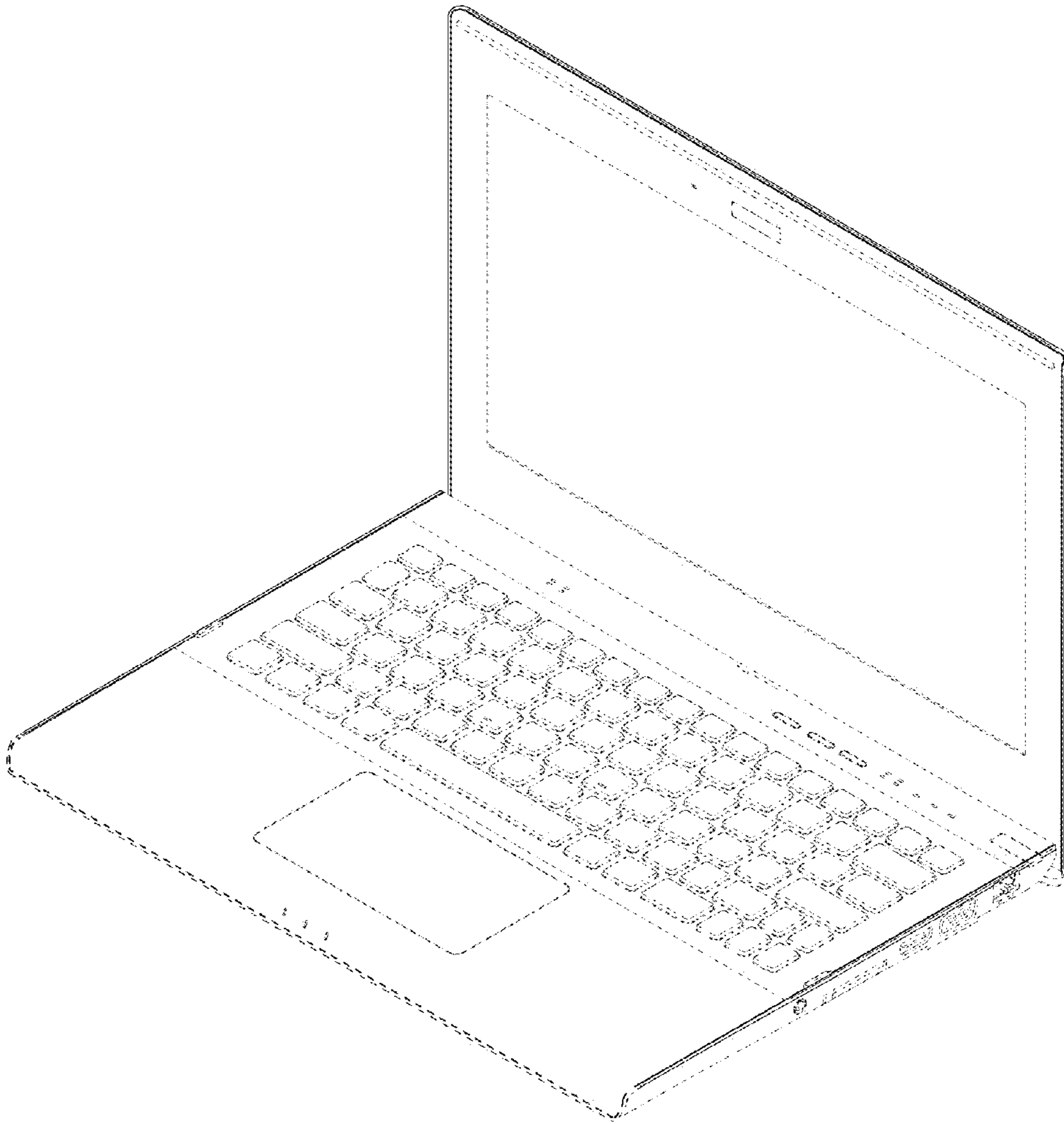

FIG.31

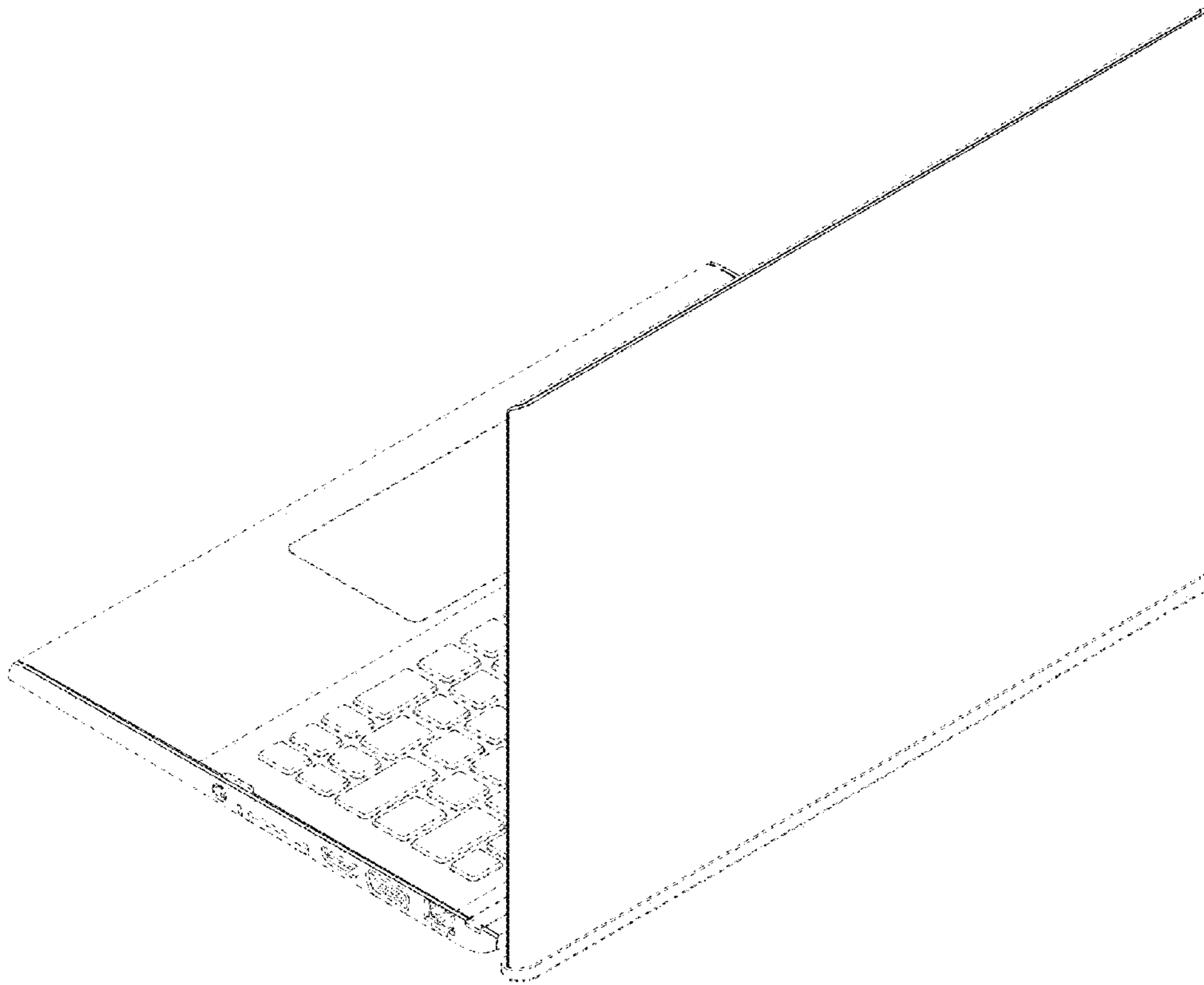

FIG.32

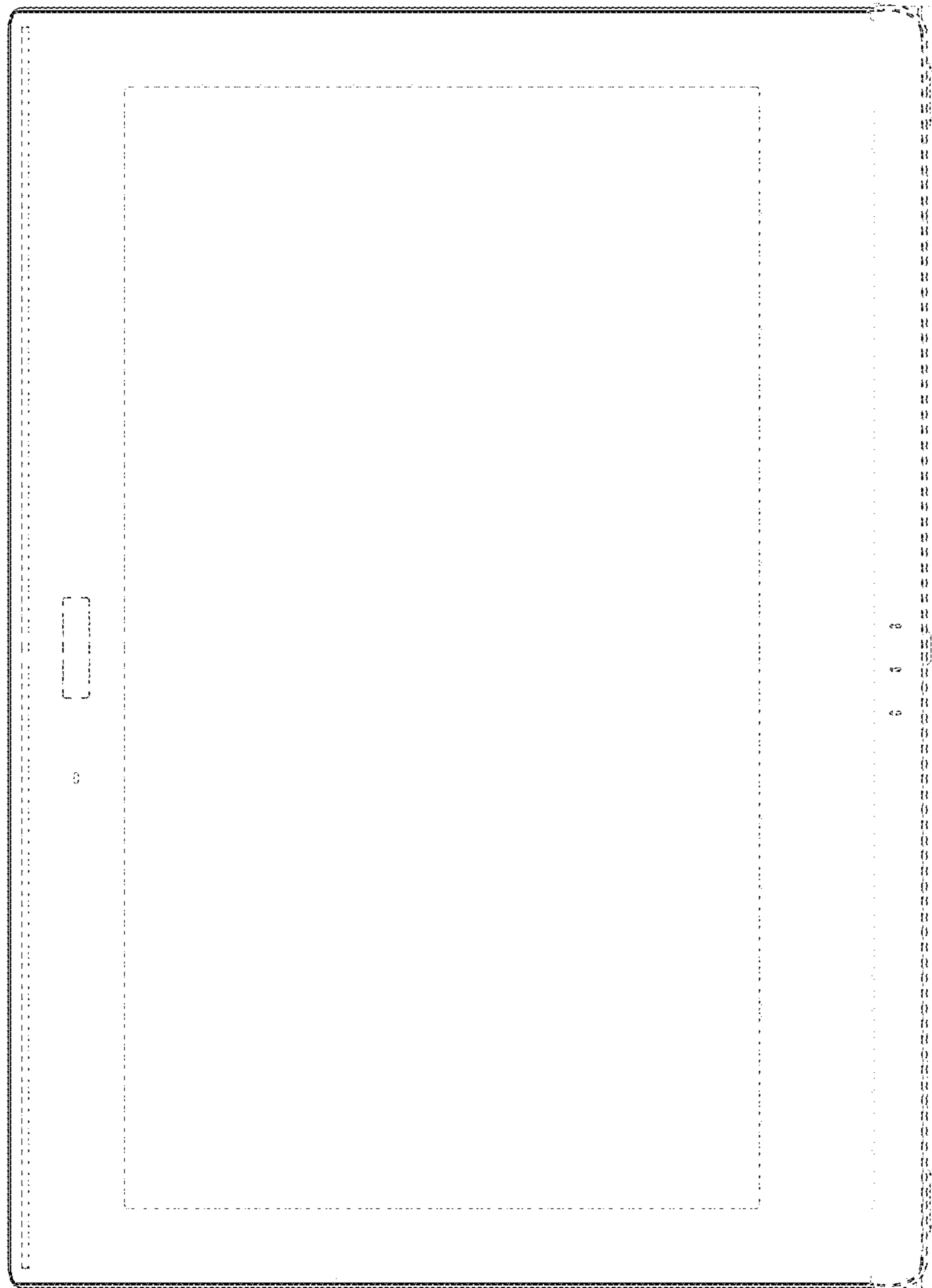

FIG. 33

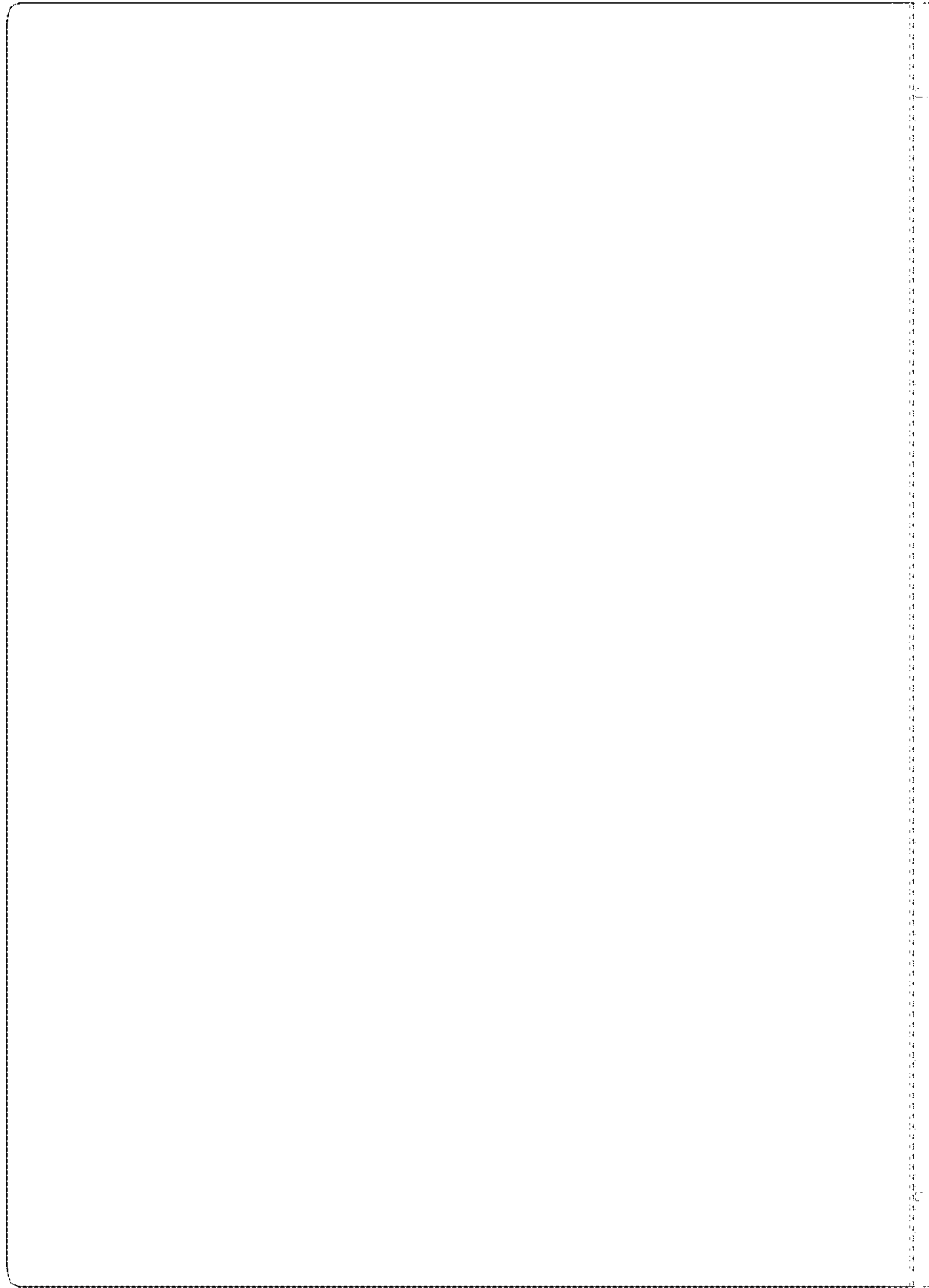

FIG.34

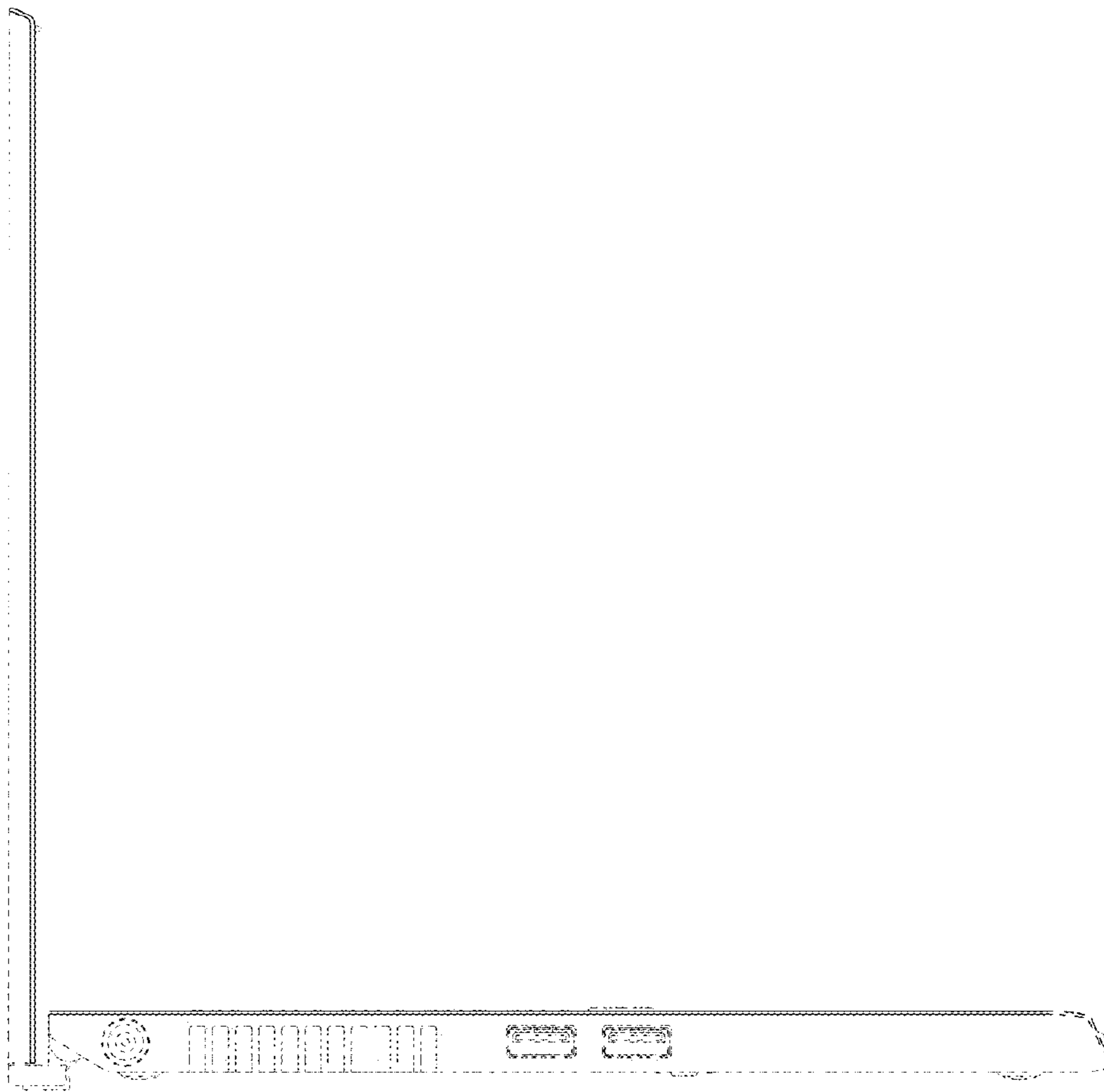

FIG.35

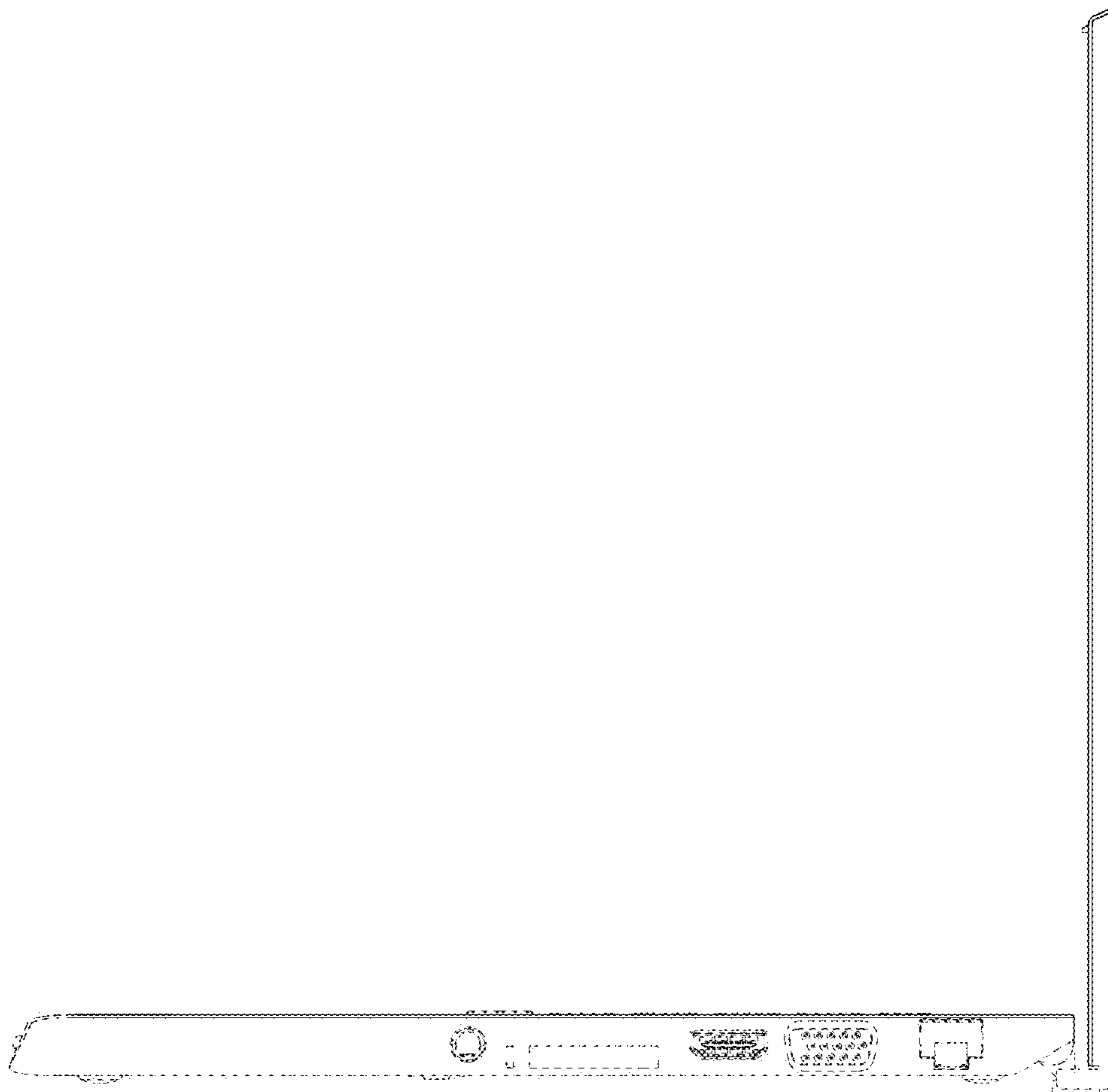

FIG.36

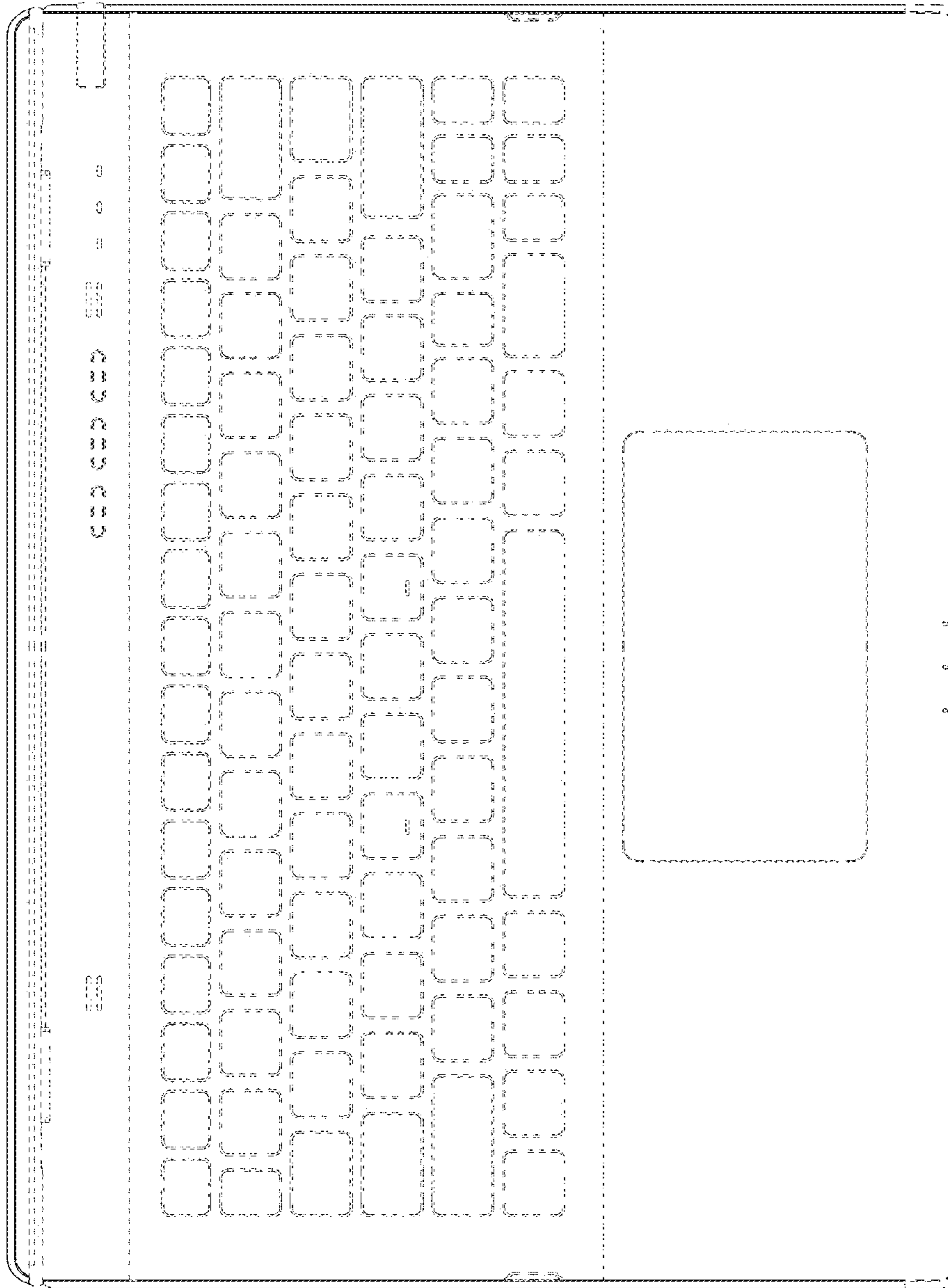

FIG. 37

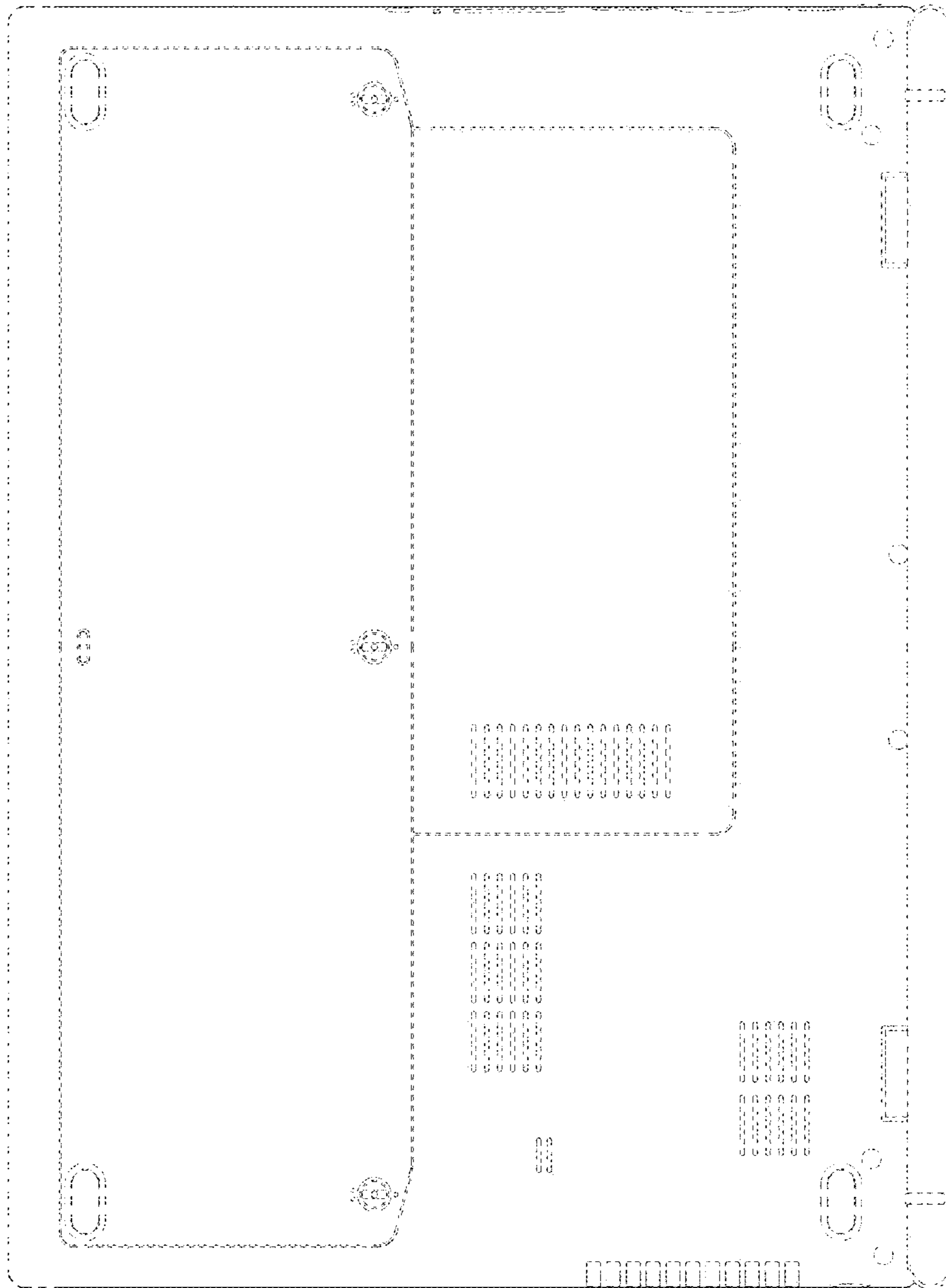

FIG.38

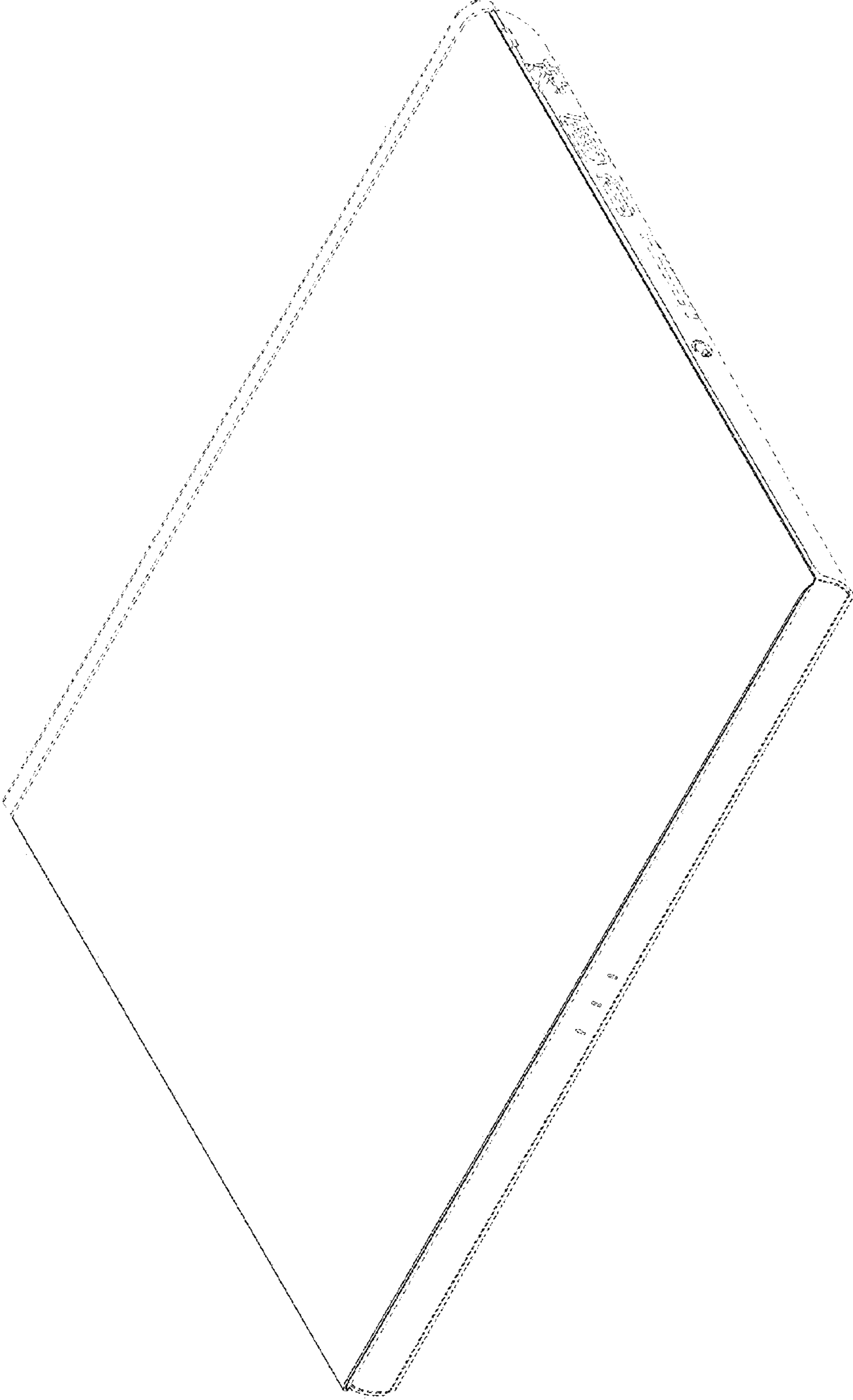

FIG. 39

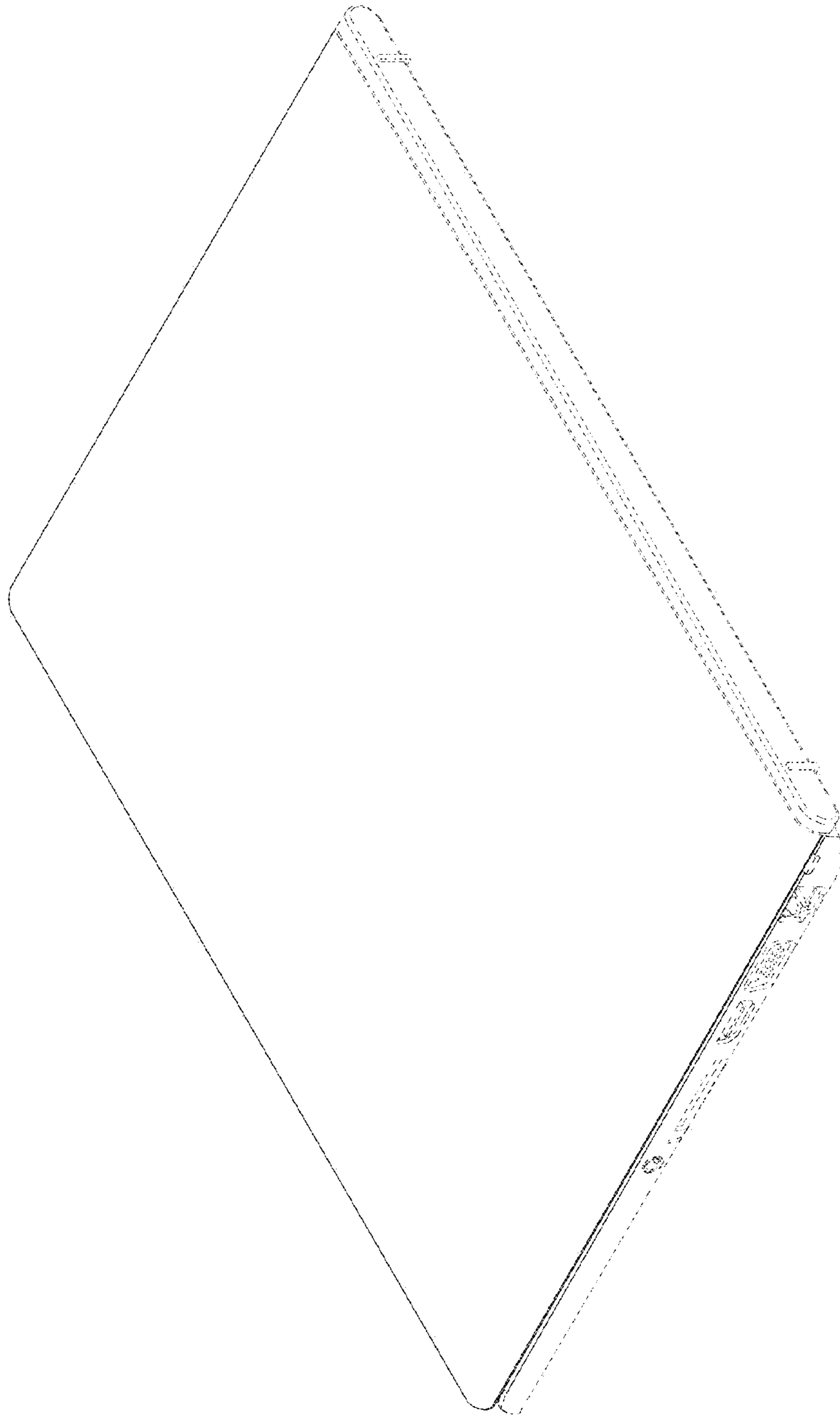

FIG.40

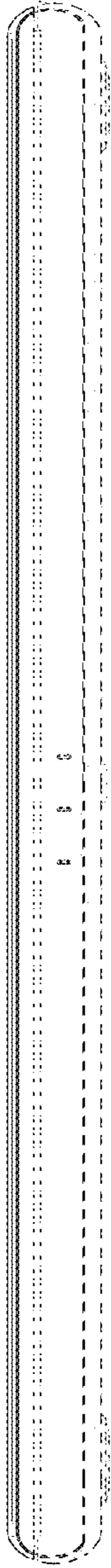

FIG.41

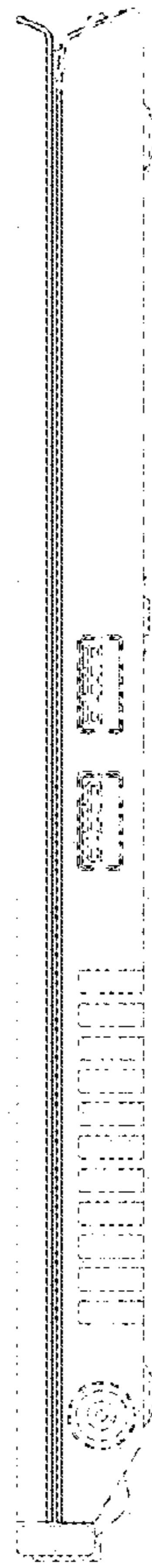

FIG.42

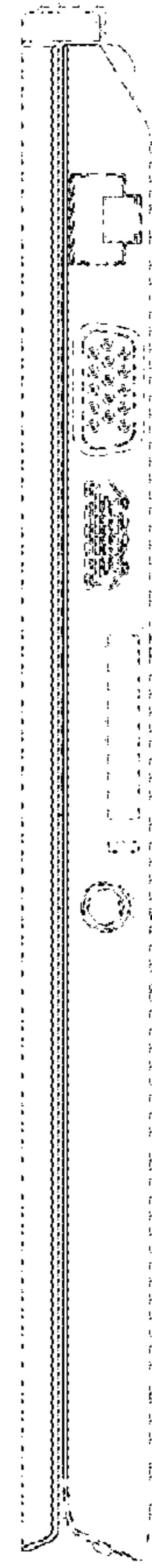

FIG.43

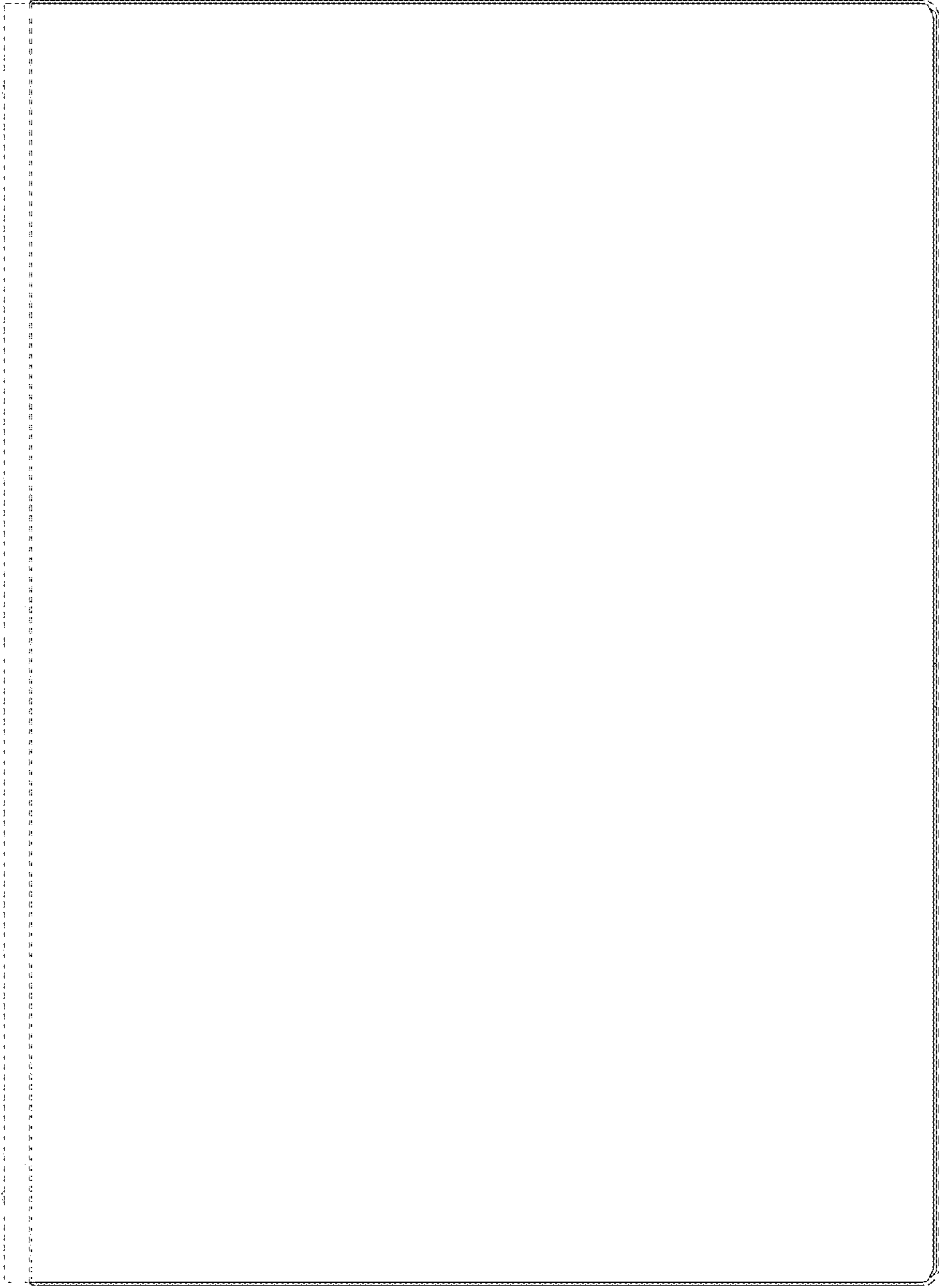

FIG.44

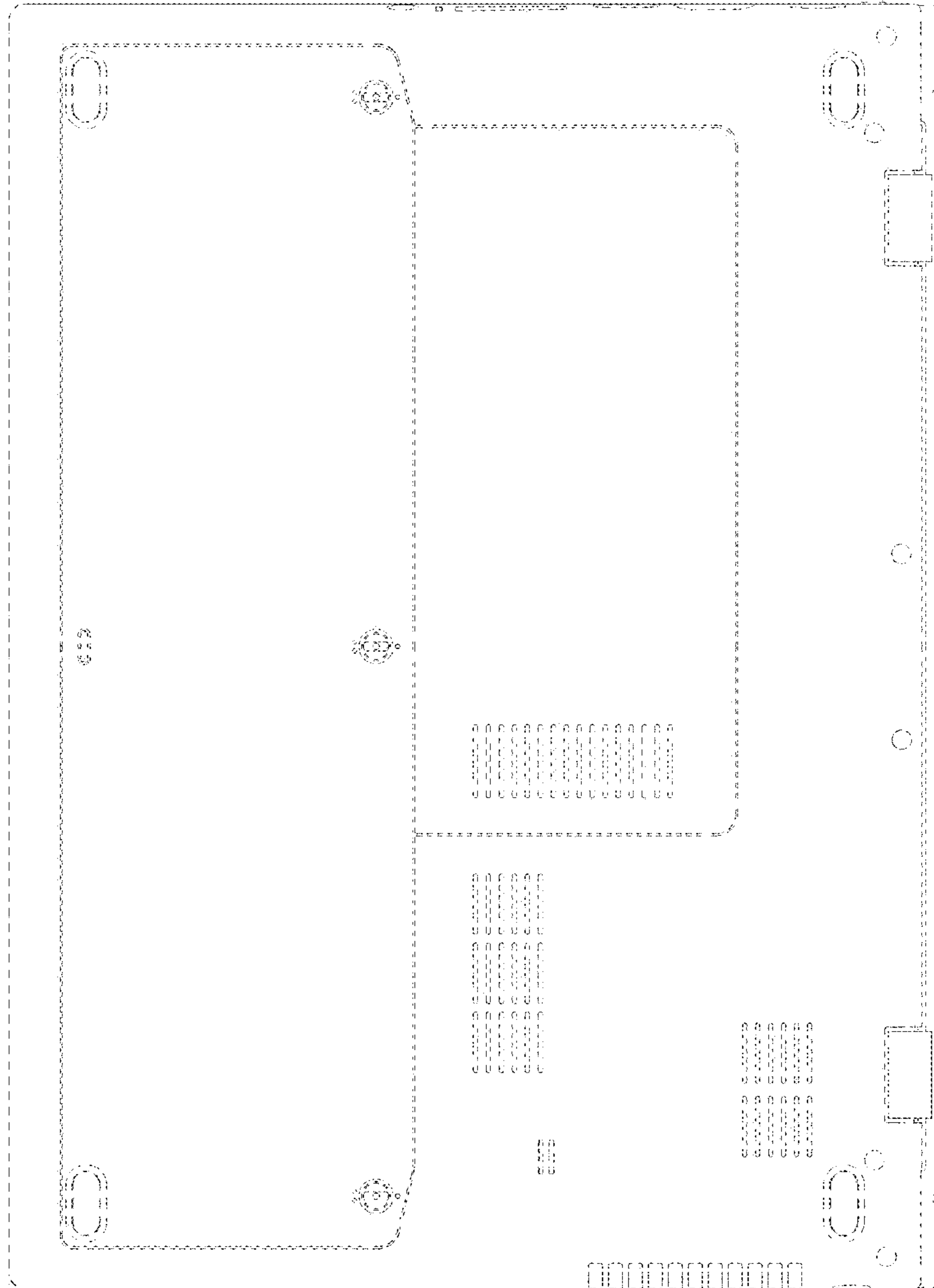

FIG.45

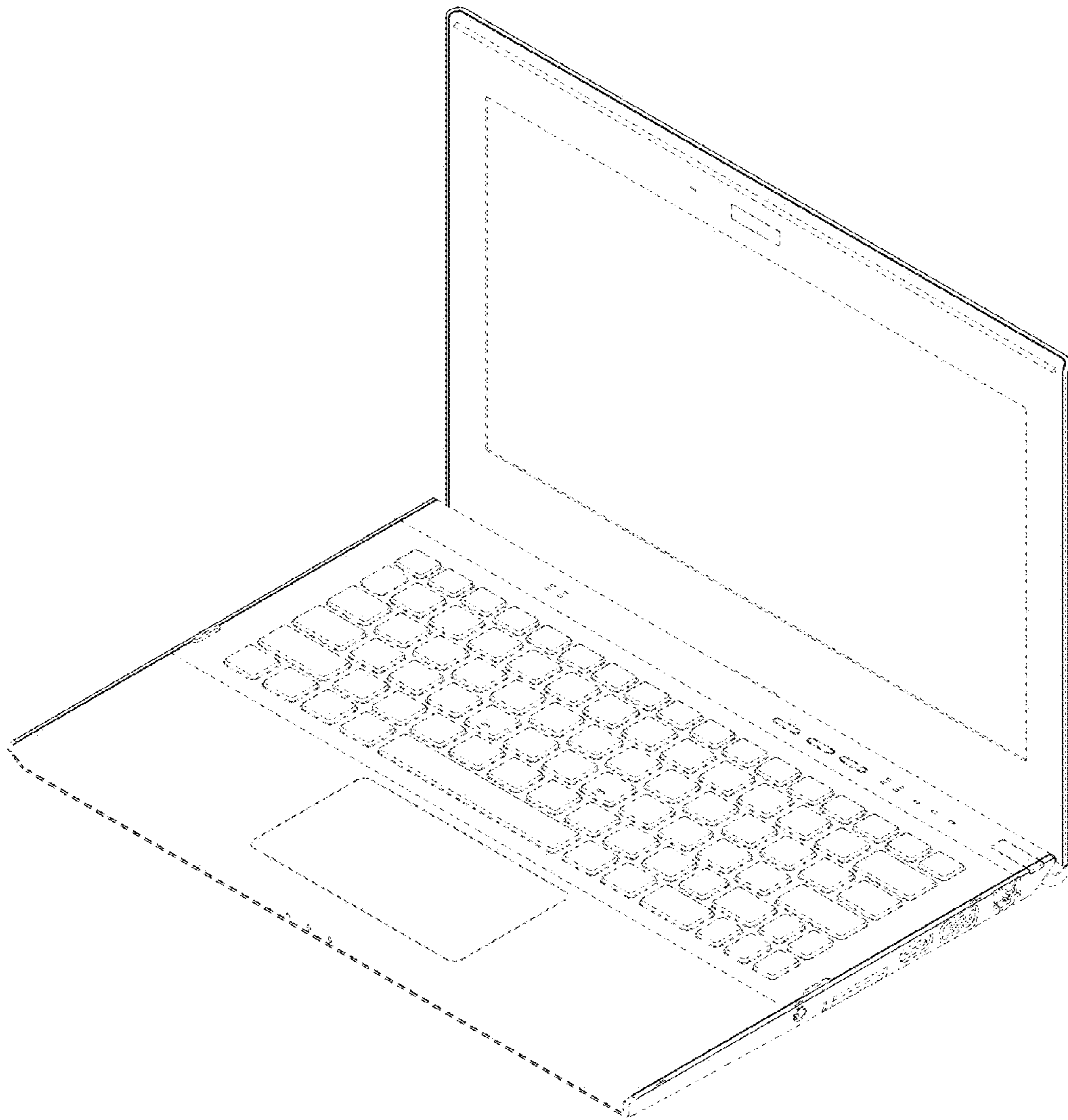

FIG.46

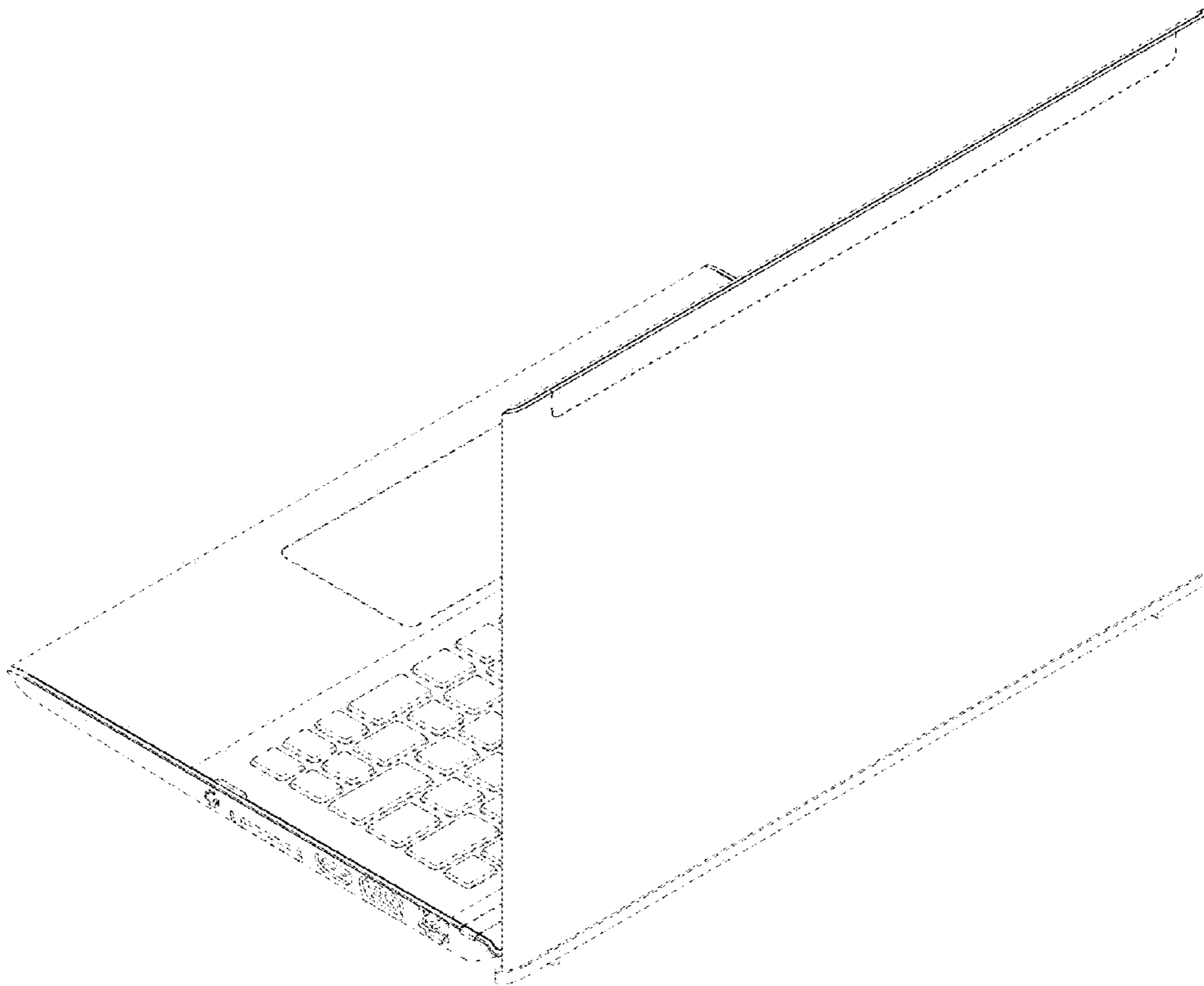

FIG.47

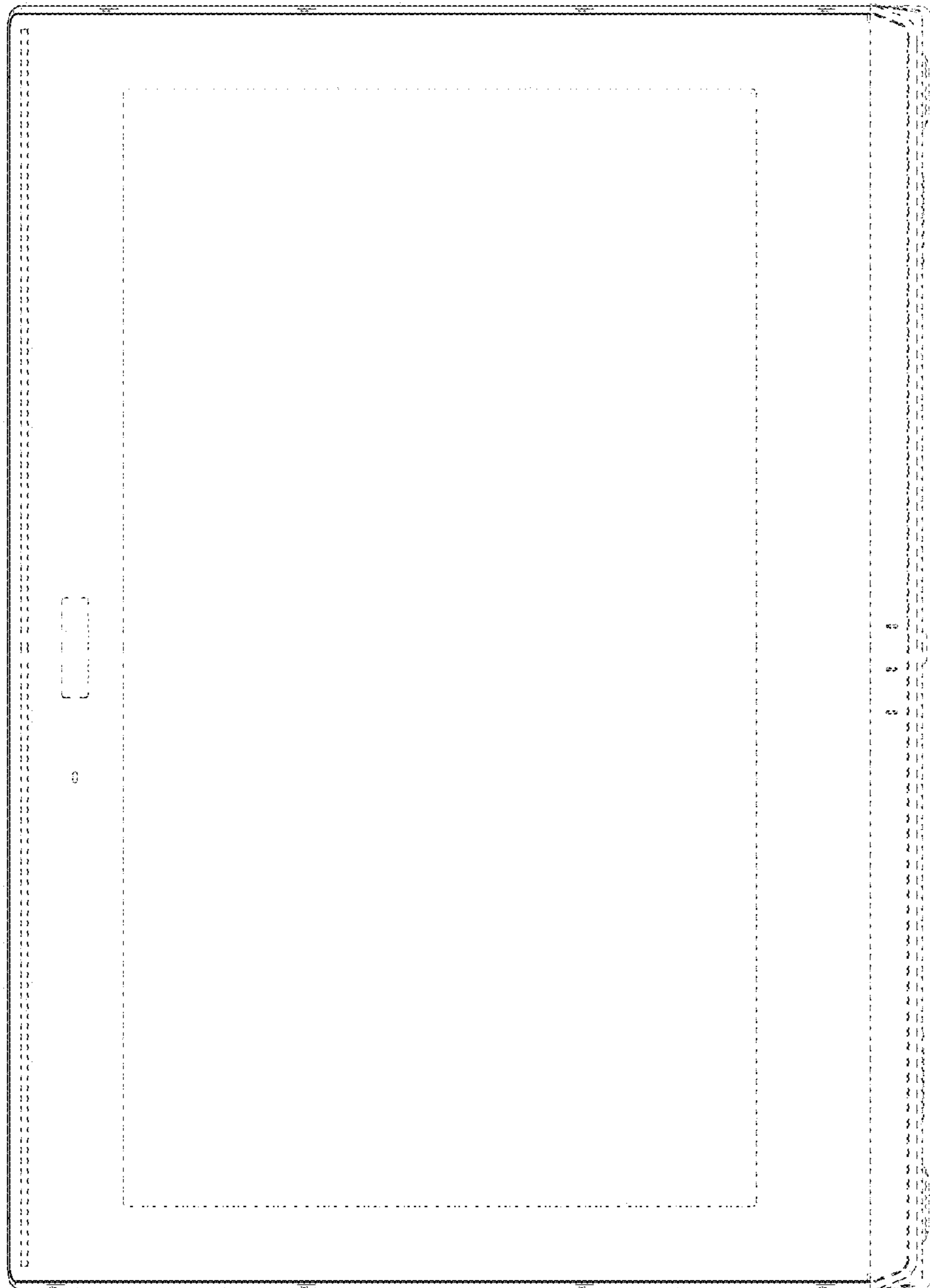

FIG.48

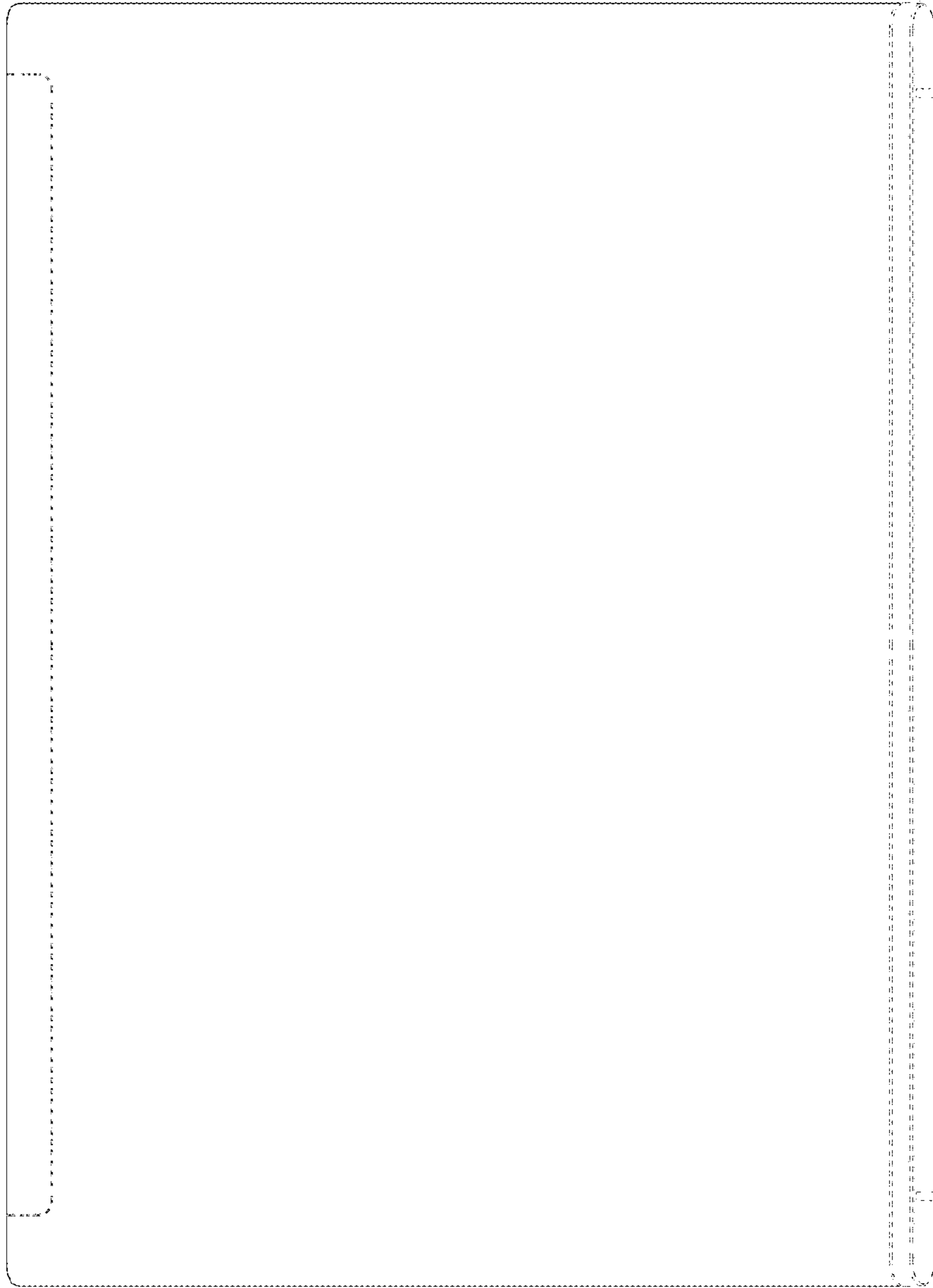

FIG.49

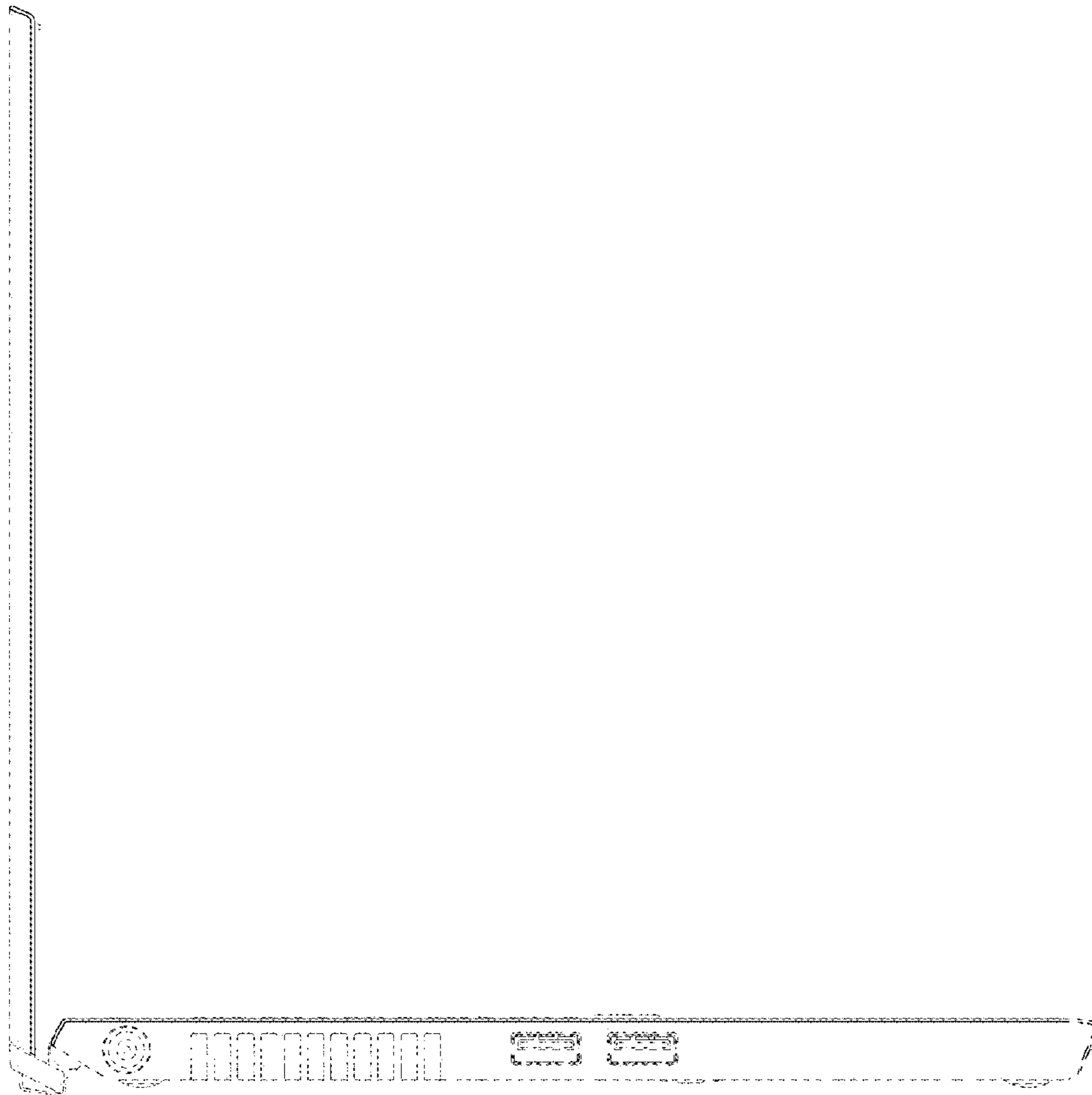

FIG. 50

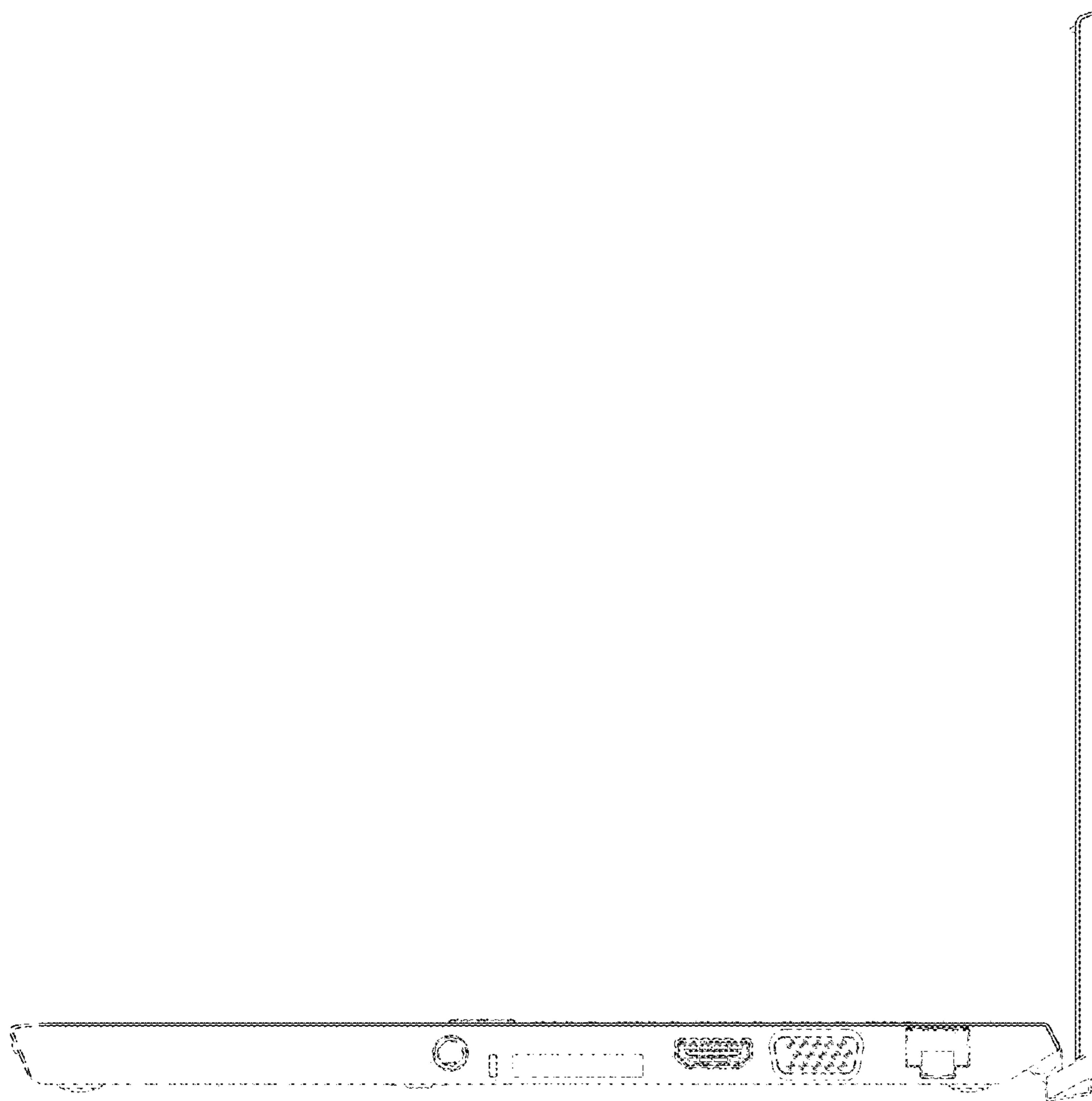

FIG. 51

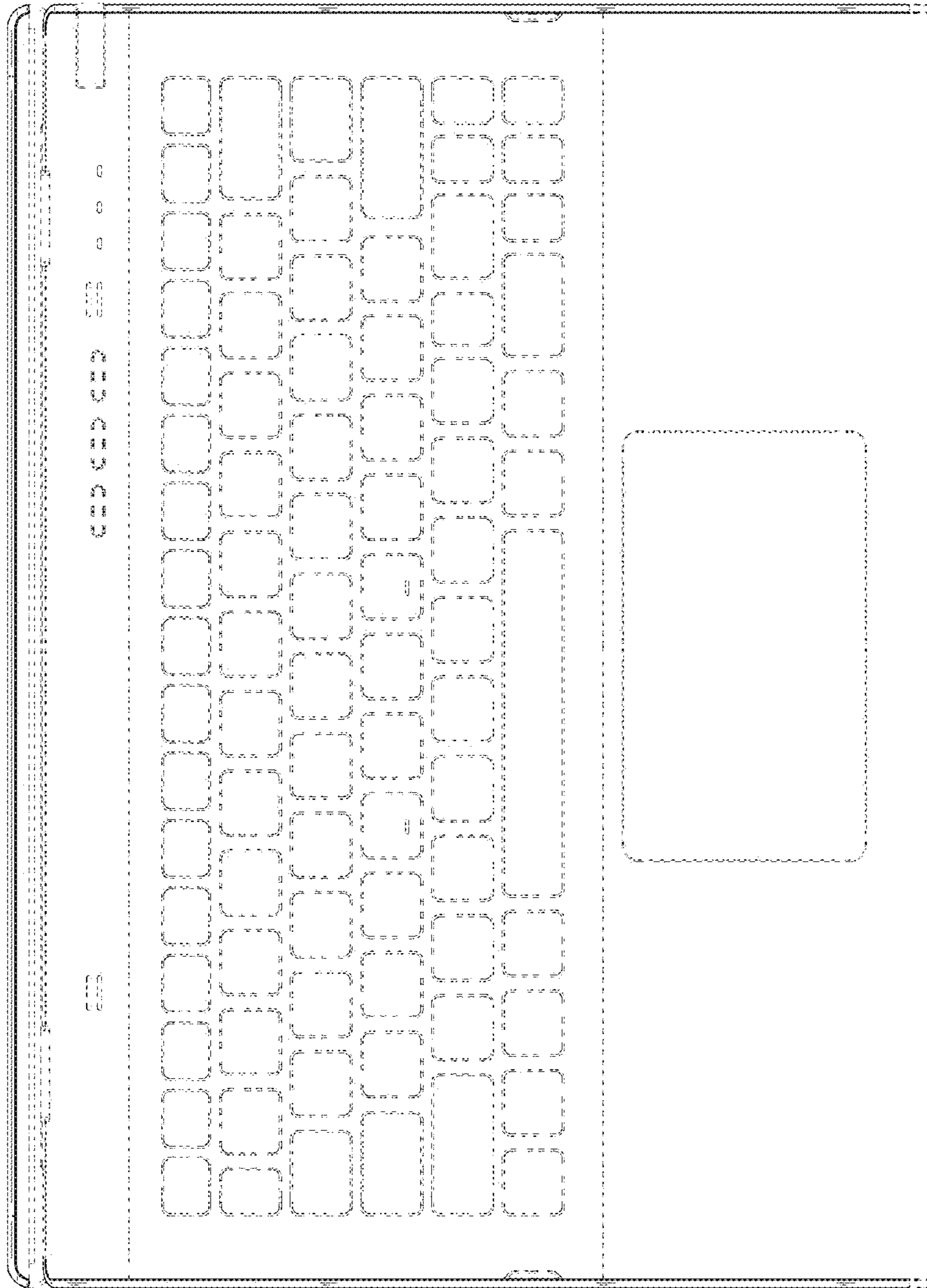

FIG. 52

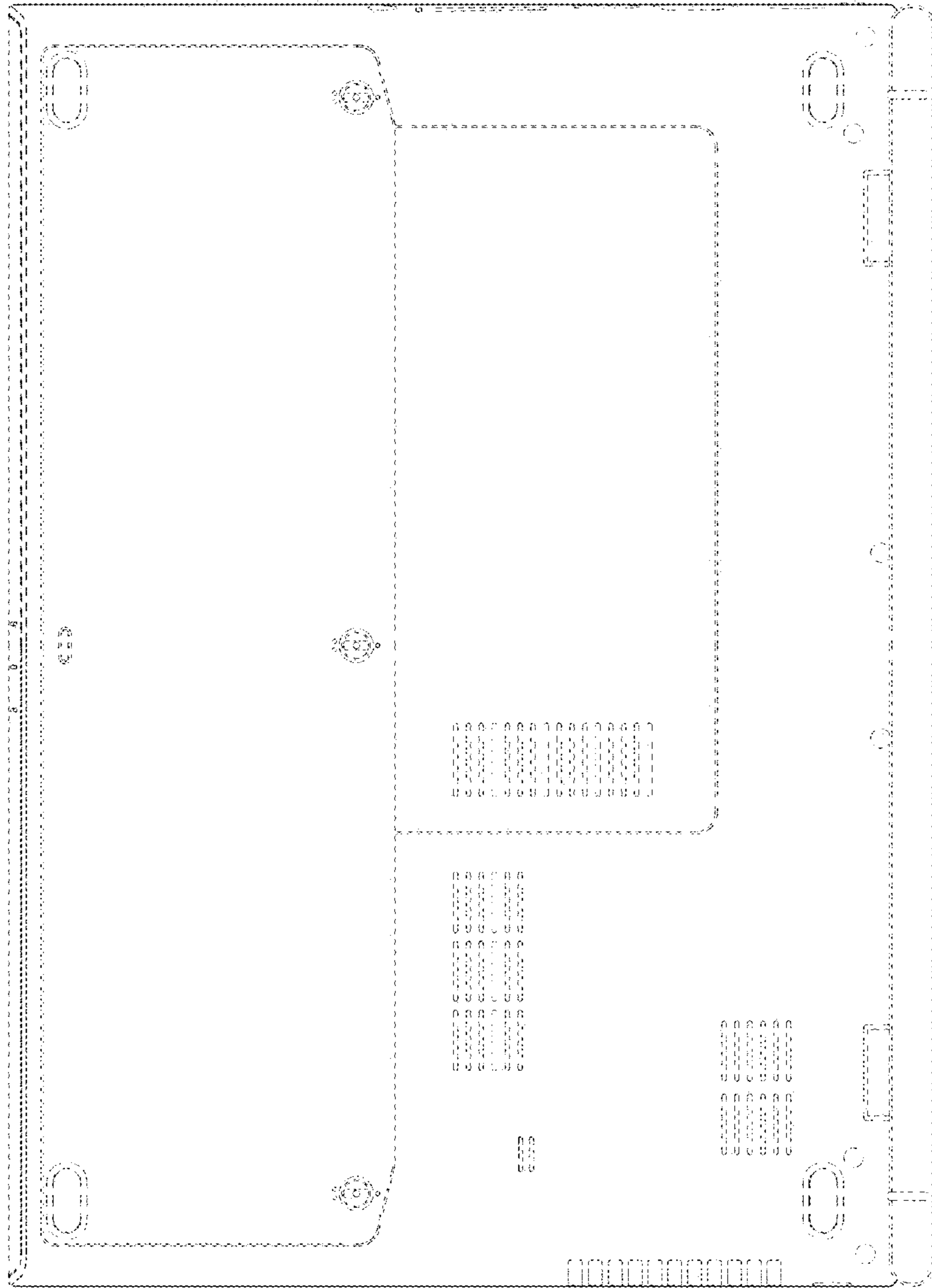

FIG. 53

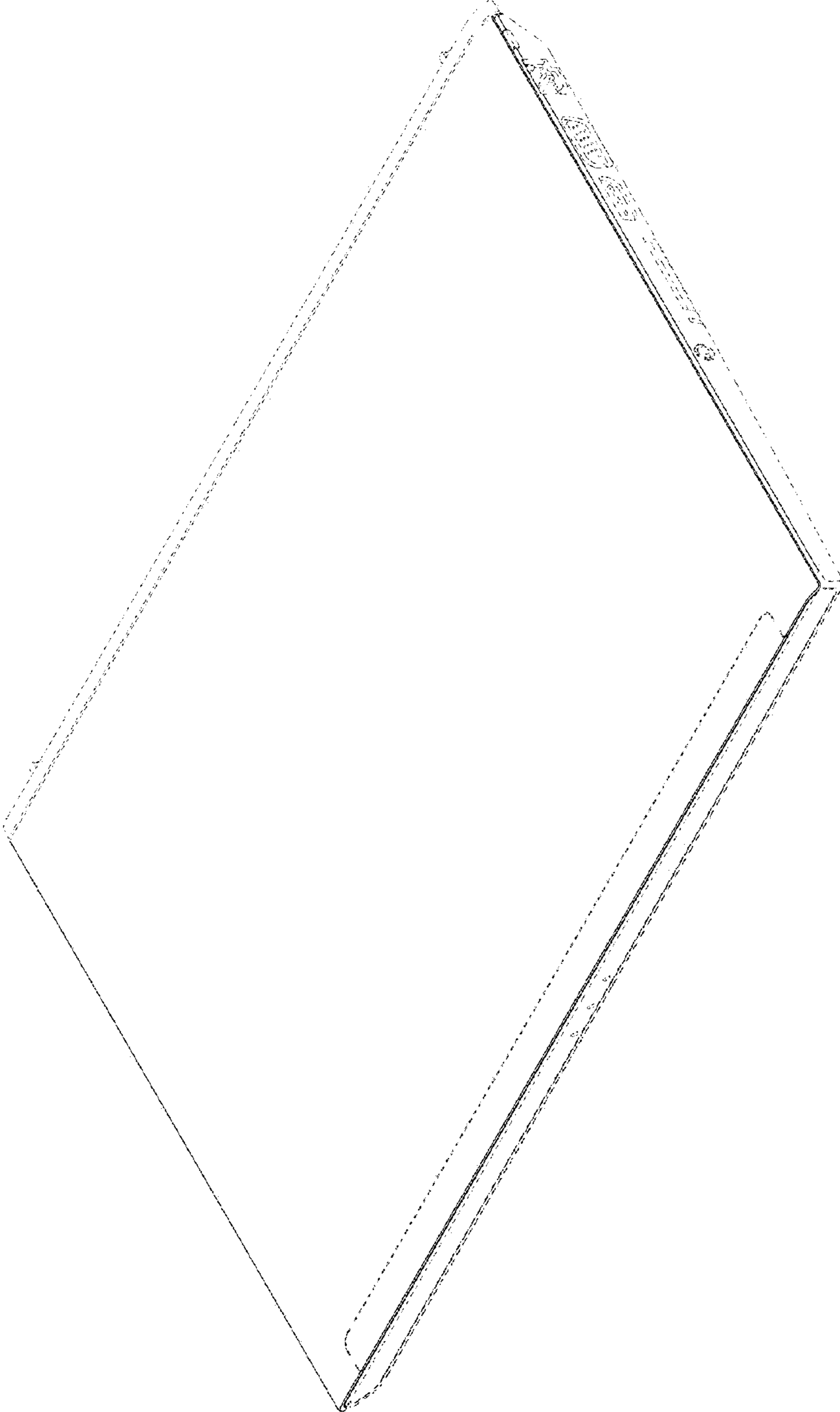
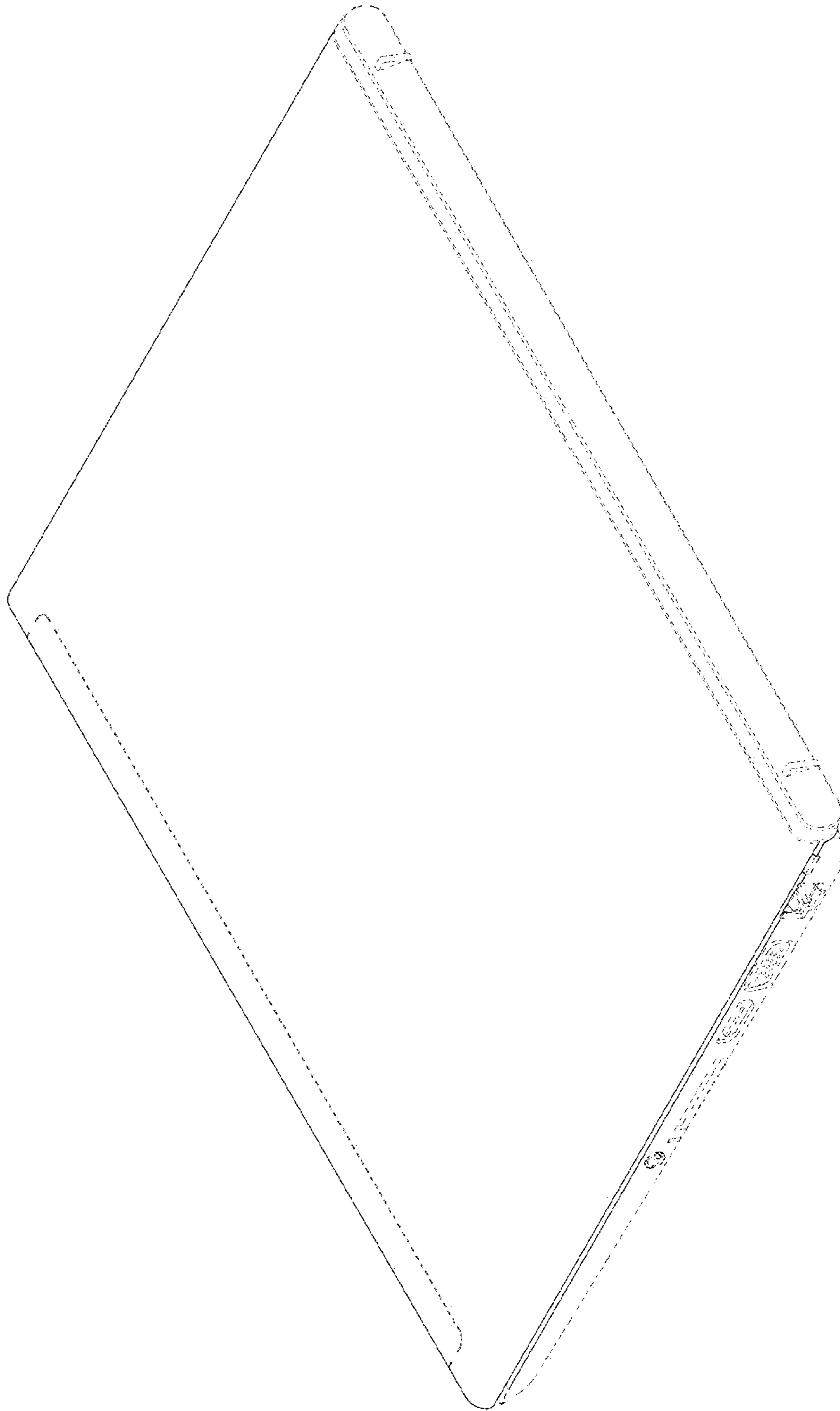

FIG. 54



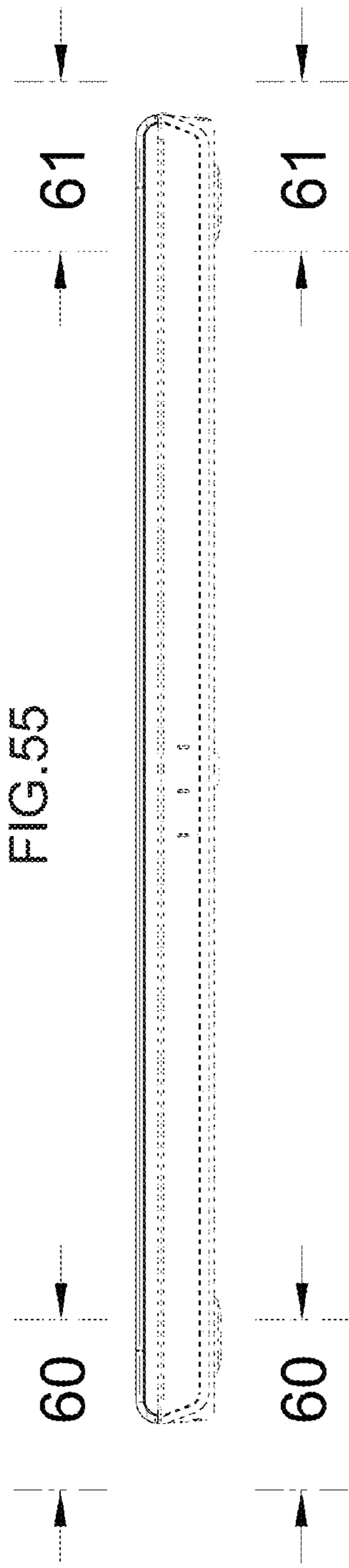

FIG. 56

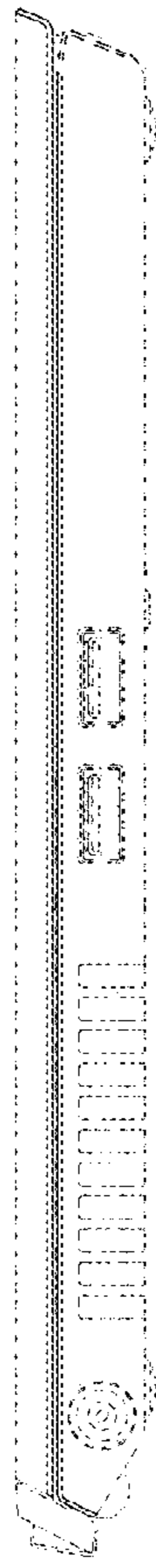

FIG. 57

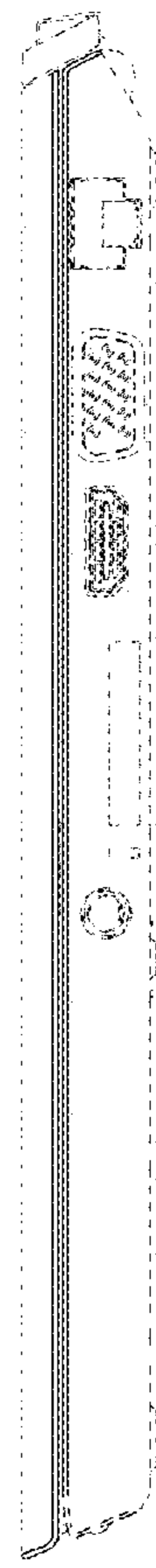

FIG. 58

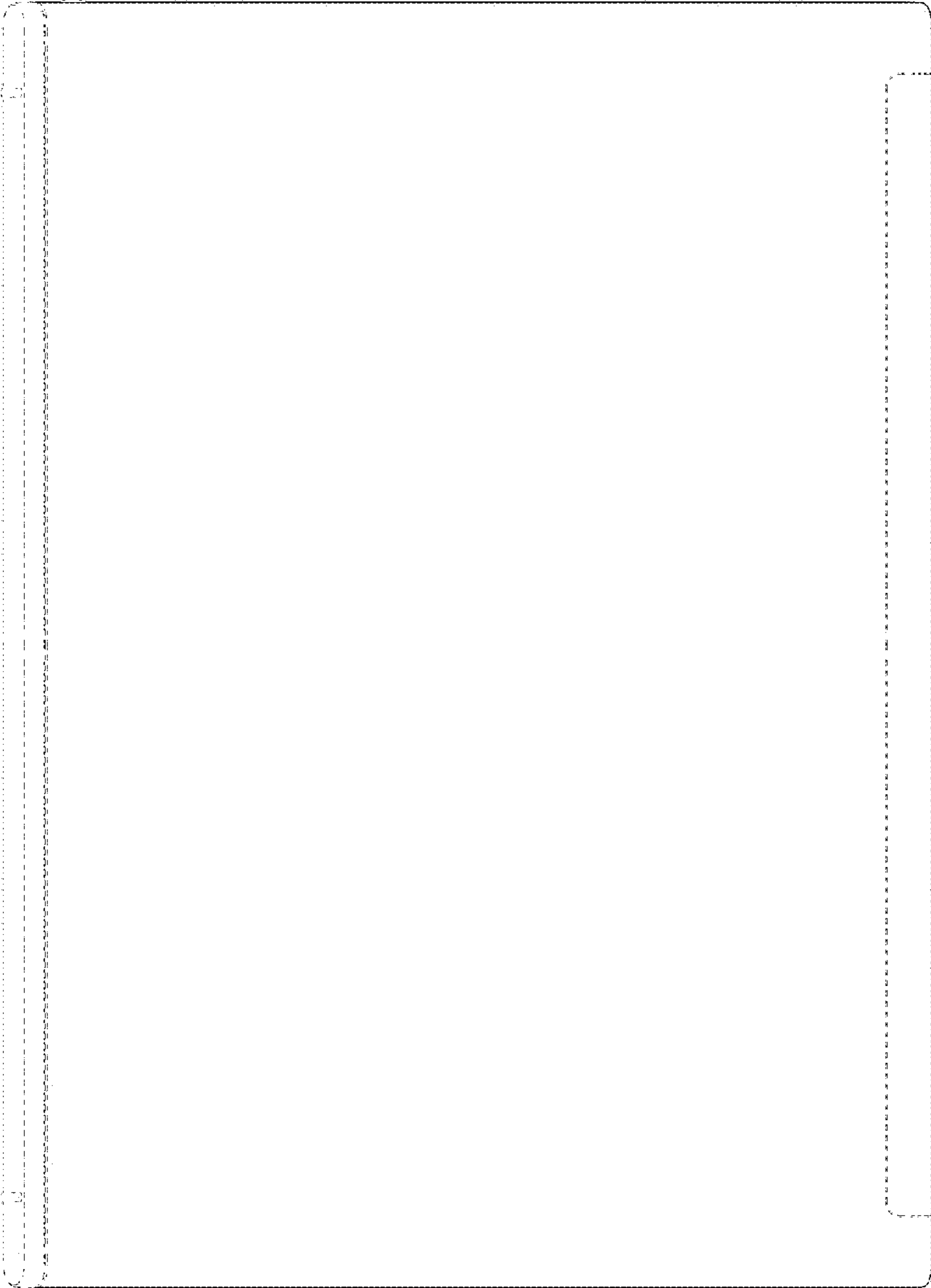

FIG. 59

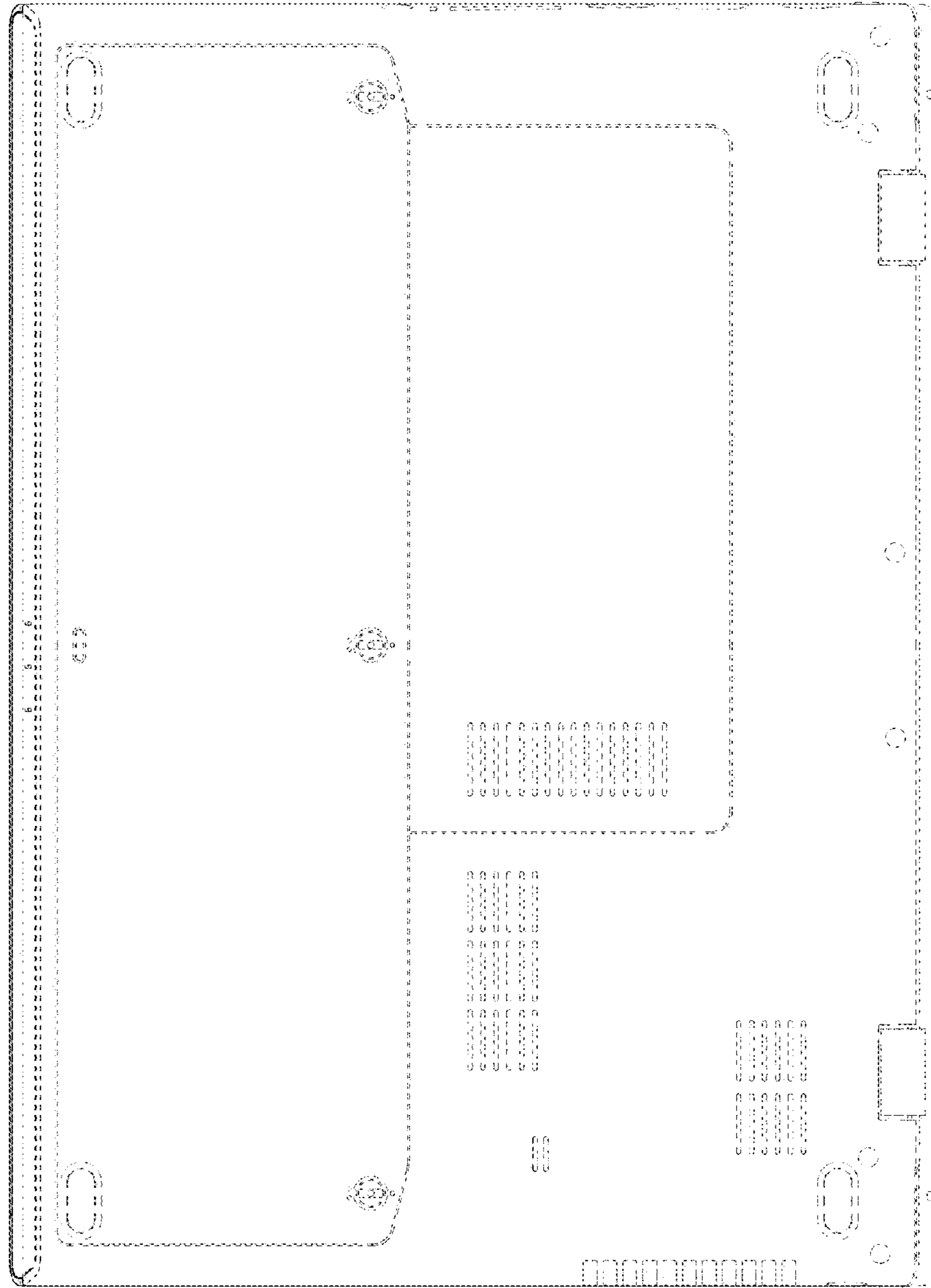

FIG.60

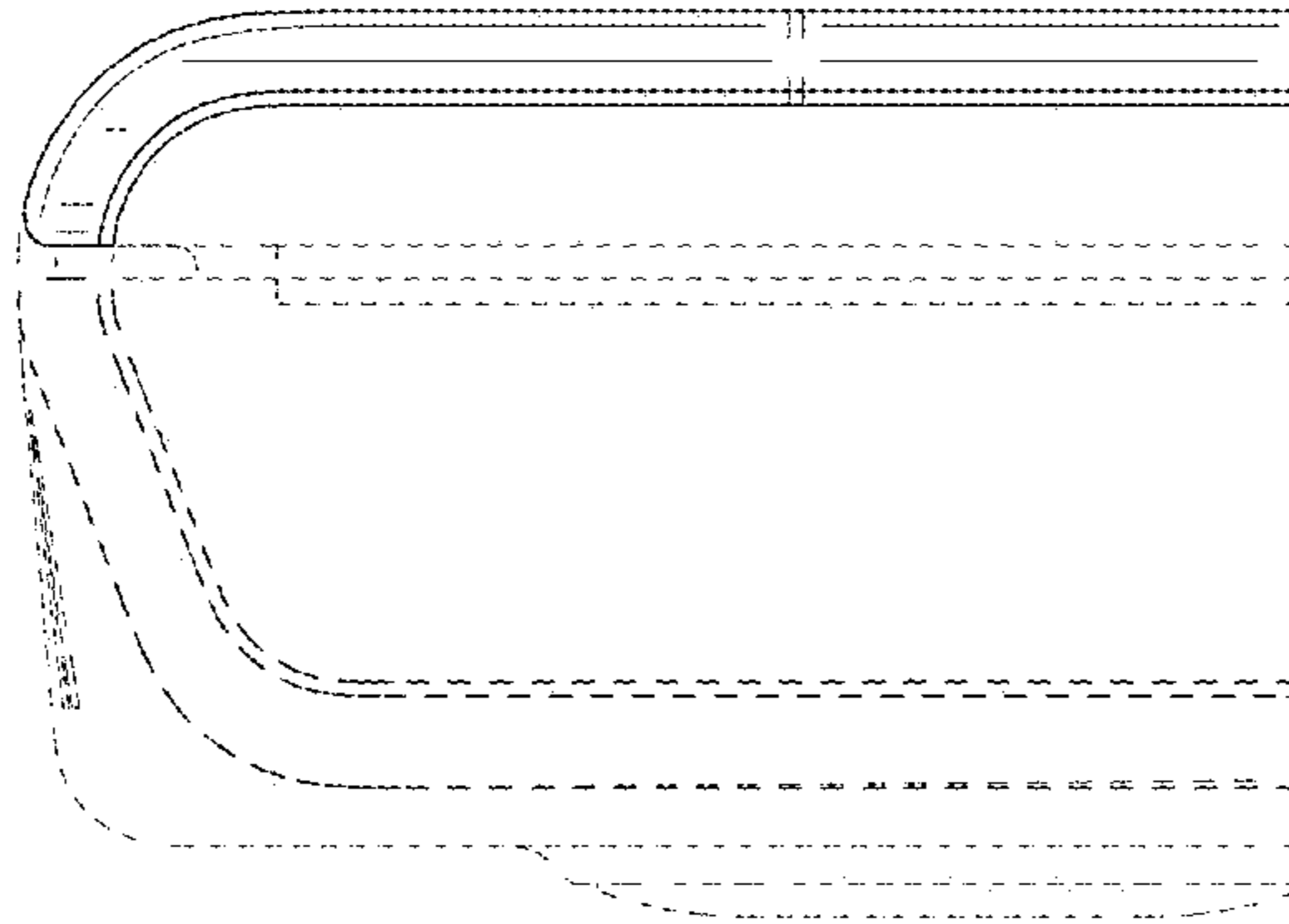

FIG.61

