



US00D683718S

(12) **United States Design Patent**
Brunner et al.

(10) **Patent No.:** **US D683,718 S**
(45) **Date of Patent:** **** Jun. 4, 2013**

(54) **AUDIO SPEAKER SYSTEM**

(75) Inventors: **Robert Brunner**, San Francisco, CA (US); **Kenny Sweet**, San Francisco, CA (US)

(73) Assignee: **Beats Electronics, LLC**, Santa Monica, CA (US)

(**) Term: **14 Years**

(21) Appl. No.: **29/400,963**

(22) Filed: **Sep. 2, 2011**

(51) **LOC (9) Cl.** **14-01**

(52) **U.S. Cl.**

USPC **D14/209.1**

(58) **Field of Classification Search**

USPC D14/204, 204.1, 210–216, 172; 181/143, 181/144, 147, 148, 150–153, 157, 198, 199; 381/300–306, 332, 333, 336, 345, 361–364

See application file for complete search history.

(56) **References Cited**

U.S. PATENT DOCUMENTS

4,388,492 A * 6/1983 Sato 381/304
5,546,468 A * 8/1996 Beard 381/86

(Continued)

OTHER PUBLICATIONS

U.S. Appl. No. 29/410,580, filed Jan. 9, 2012 (which is not being furnished herewith, pursuant to the Commissioner’s Notice dated Sep. 21, 2004).

Primary Examiner — Prabhakar Deshmukh

(74) *Attorney, Agent, or Firm* — Michael G. Kelber; Neal, Gerber & Eisenberg LLP

(57) **CLAIM**

The ornamental design for audio speaker system, as shown and described.

DESCRIPTION

FIG. 1 is a top perspective view of the audio speaker system in accordance with the present invention;

FIG. 2 is a front view of the embodiment of the audio speaker system depicted in FIG. 1;

FIG. 3 is a rear view of the embodiment of the audio speaker system depicted in FIG. 1;

FIG. 4 is a left side view of the embodiment of the audio speaker system depicted in FIG. 1;

FIG. 5 is a right side view of the embodiment of the audio speaker system depicted in FIG. 1;

FIG. 6 is a top view of the embodiment of the audio speaker system depicted in FIG. 1;

FIG. 7 is a bottom view of the embodiment of the audio speaker system depicted in FIG. 1;

FIG. 8 is a top perspective view of a second embodiment of an audio speaker system in accordance with the present invention;

FIG. 9 is a front view of the embodiment of the audio speaker system depicted in FIG. 8;

FIG. 10 is a rear view of the embodiment of the audio speaker system depicted in FIG. 8;

FIG. 11 is a left side view of the embodiment of the audio speaker system depicted in FIG. 8;

FIG. 12 is a right side view of the embodiment of the audio speaker system depicted in FIG. 8;

FIG. 13 is a top view of the embodiment of the audio speaker system depicted in FIG. 8;

FIG. 14 is a bottom view of the embodiment of the audio speaker system depicted in FIG. 8;

FIG. 15 is a top perspective view of a third embodiment of an audio speaker system in accordance with the present invention;

FIG. 16 is a front view of the embodiment of the audio speaker system depicted in FIG. 15;

FIG. 17 is a rear view of the embodiment of the audio speaker system depicted in FIG. 8;

FIG. 18 is a left side view of the embodiment of the audio speaker system depicted in FIG. 15;

FIG. 19 is a right side view of the embodiment of the audio speaker system depicted in FIG. 15;

FIG. 20 is a top view of the embodiment of the audio speaker system depicted in FIG. 15; and,

FIG. 21 is a bottom view of the embodiment of the audio speaker system depicted in FIG. 15.

The broken lines showing the environment in the Figures are for illustrative purposes only and form no part of the claimed design.

1 Claim, 12 Drawing Sheets

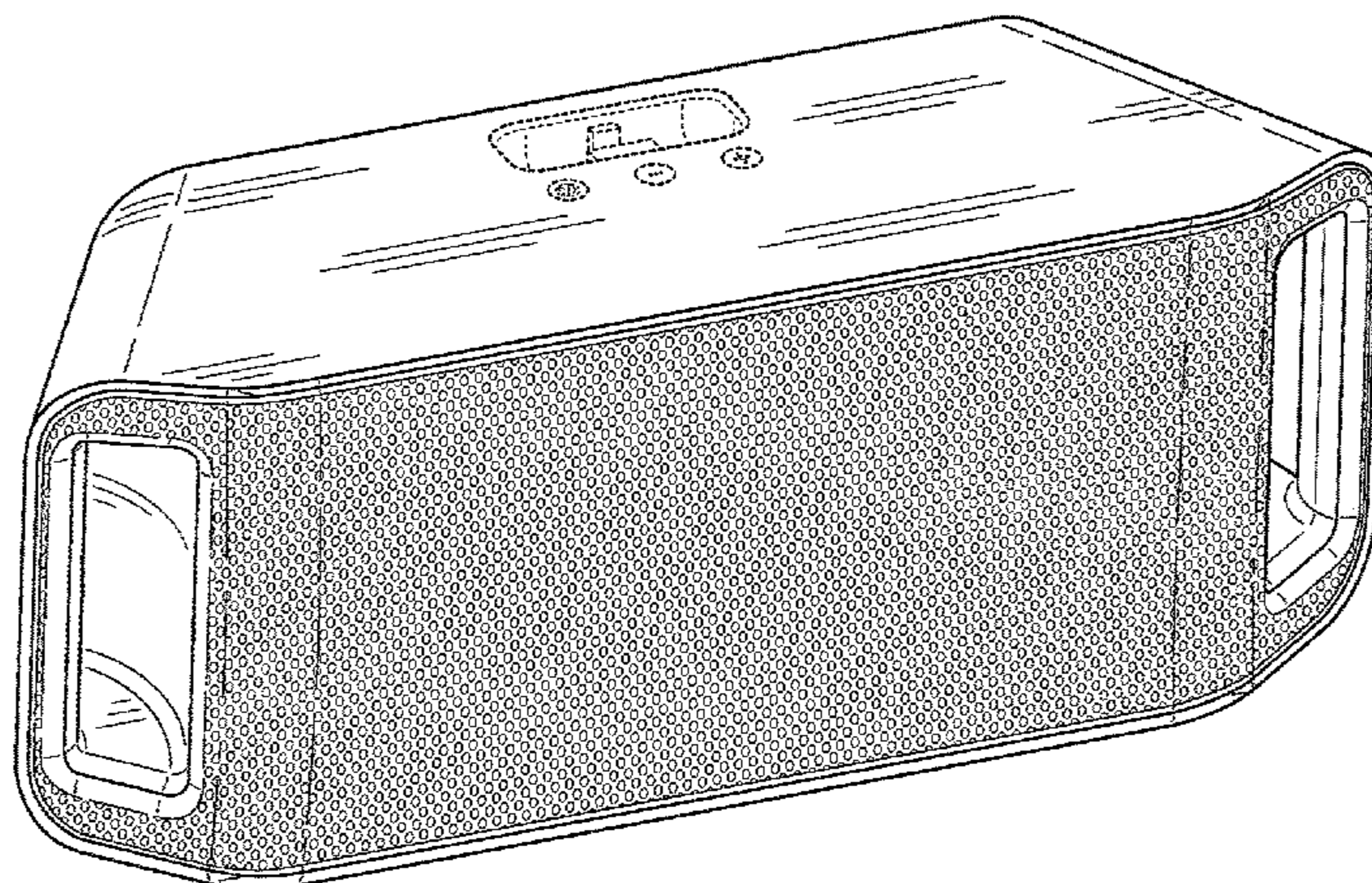

US D683,718 S

Page 2

U.S. PATENT DOCUMENTS

7,095,867	B2 *	8/2006	Schul et al.	381/334	D616,420	S *	5/2010	Morimoto	D14/216
D556,732	S *	12/2007	Chan et al.	D14/168	D620,921	S *	8/2010	Skurdal	D14/209.1
D566,730	S *	4/2008	Lee	D14/496	D620,923	S *	8/2010	Orfali	D14/209.1
D572,702	S *	7/2008	Bart	D14/171	D625,288	S *	10/2010	Ueda	D14/209.1
D573,579	S *	7/2008	Yamaguchi	D14/500	D636,378	S *	4/2011	Ohashi et al.	D14/209.1
D583,360	S *	12/2008	Gredler	D14/171	D636,758	S *	4/2011	Tzeng	D14/214
D587,675	S *	3/2009	Xie	D14/172	D642,156	S *	7/2011	Joseph	D14/209.1
D599,782	S *	9/2009	Tse	D14/209.1	D642,159	S *	7/2011	Joseph	D14/215
D600,251	S *	9/2009	Poandl	D14/496	D659,119	S *	5/2012	Brunner et al.	D14/209.1
D607,536	S *	1/2010	Filo	D23/205	8,180,095	B2 *	5/2012	Zhang	381/387
7,689,197	B2 *	3/2010	Laude et al.	455/344					

* cited by examiner

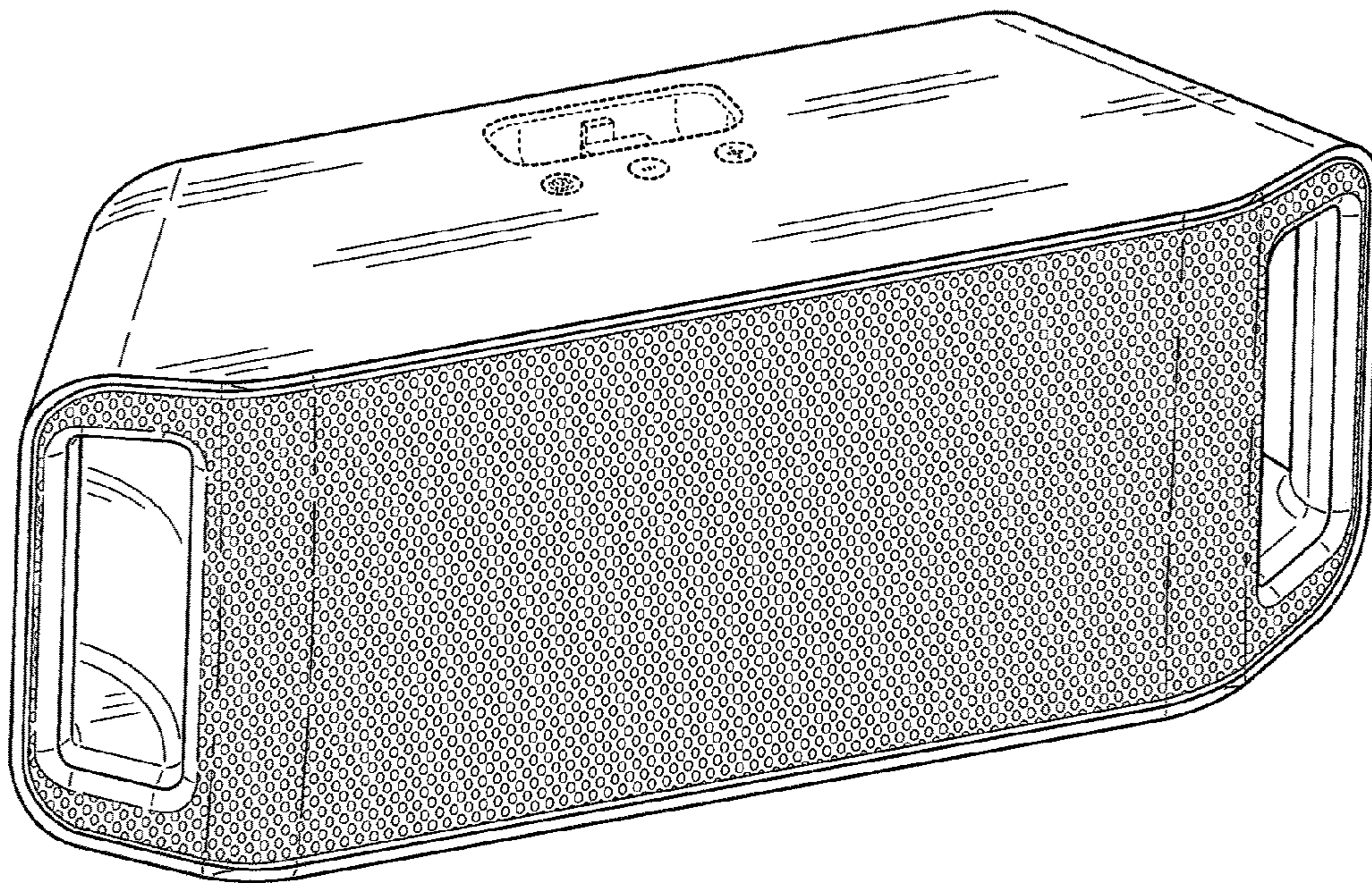

FIG. 1

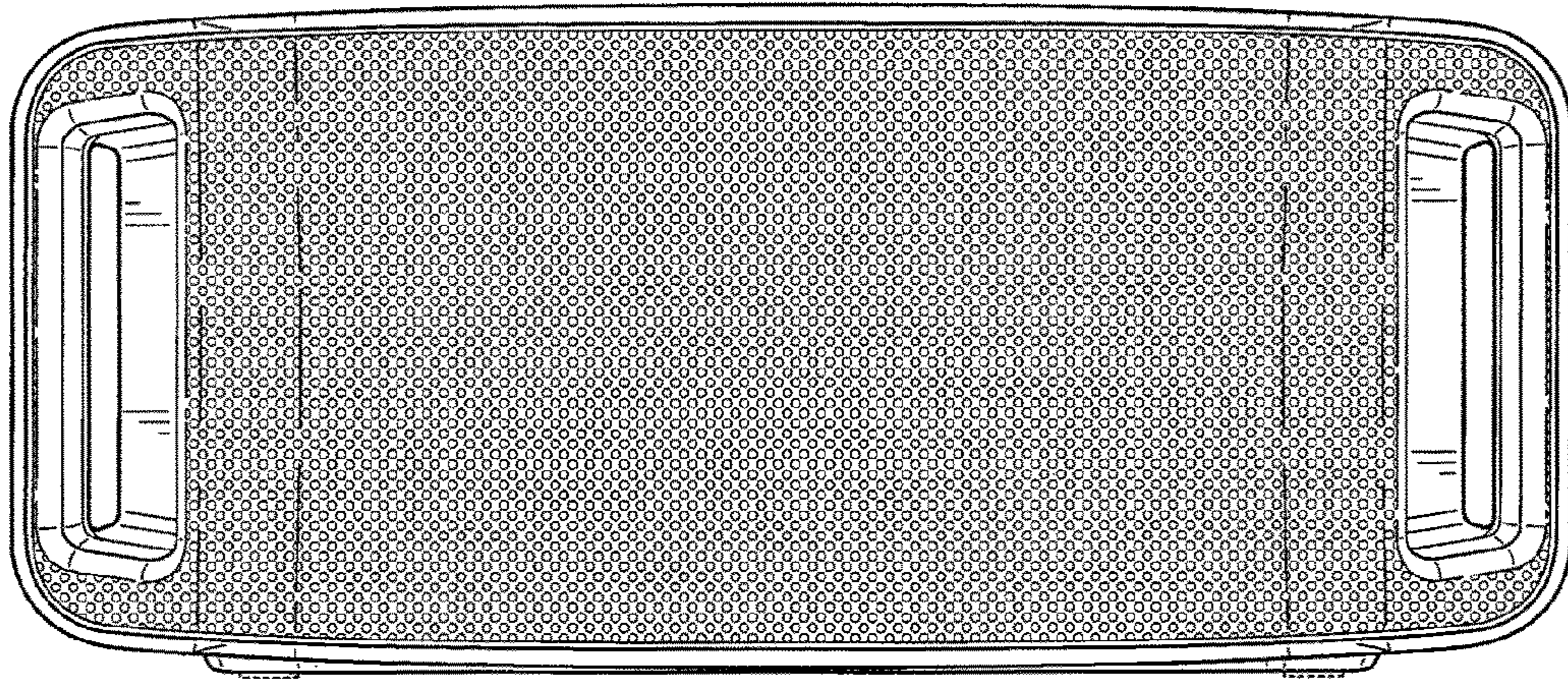

FIG. 2

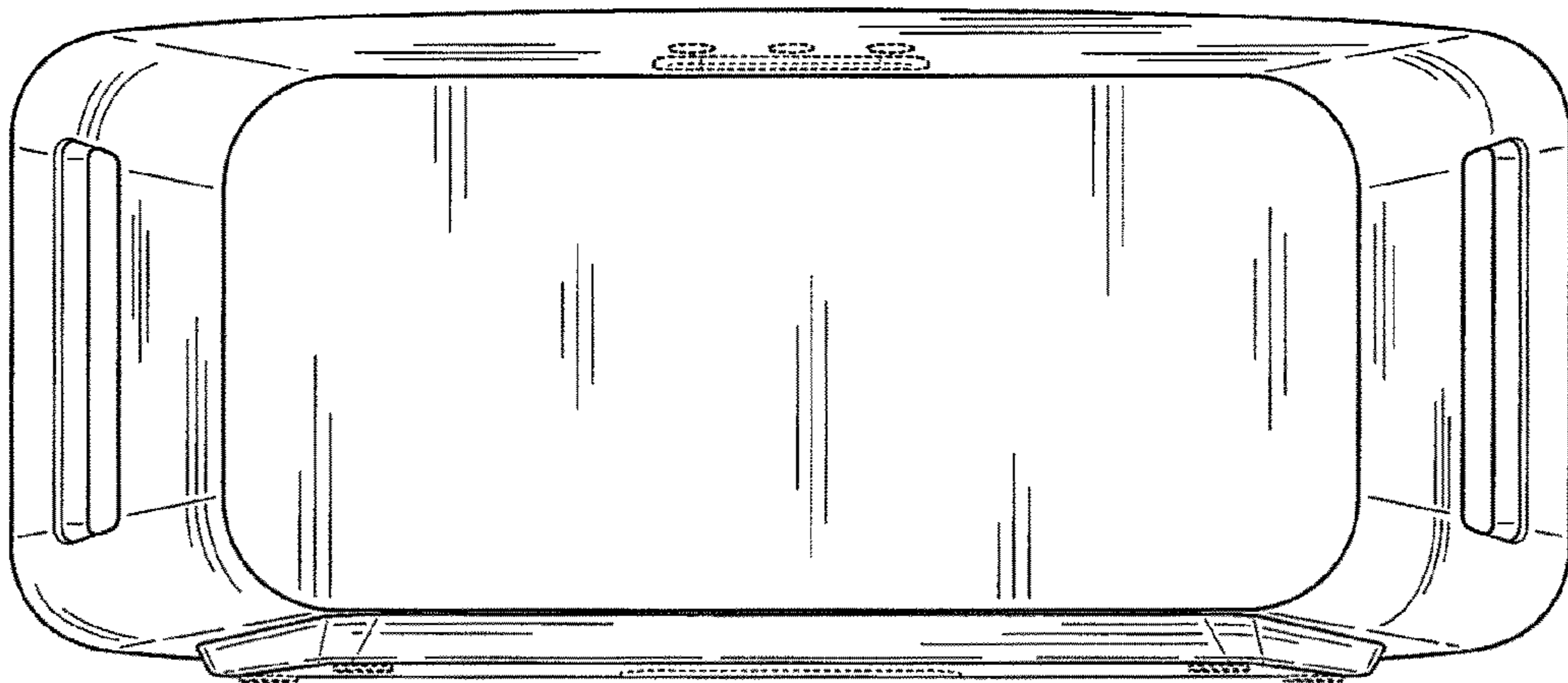

FIG. 3

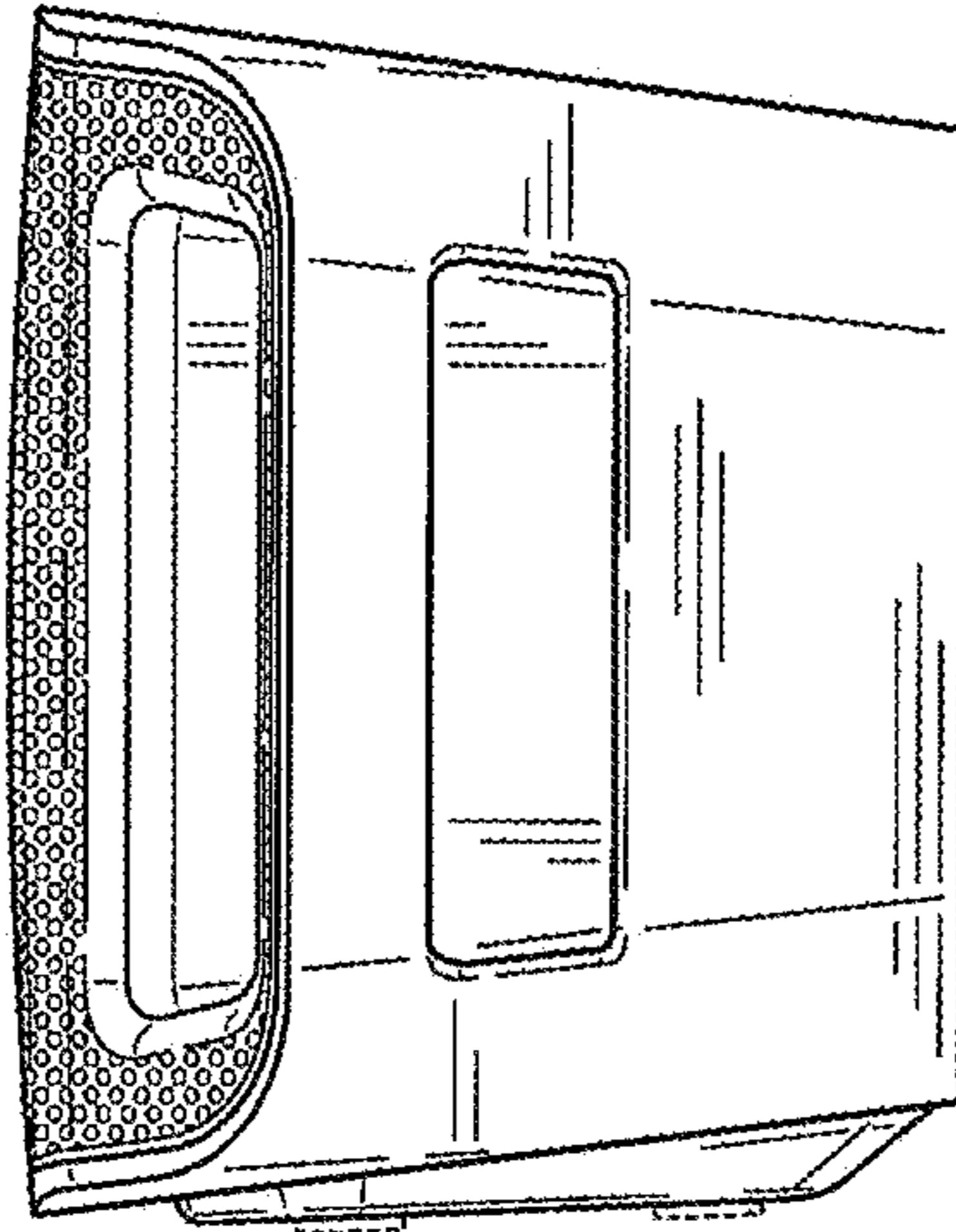

FIG. 4

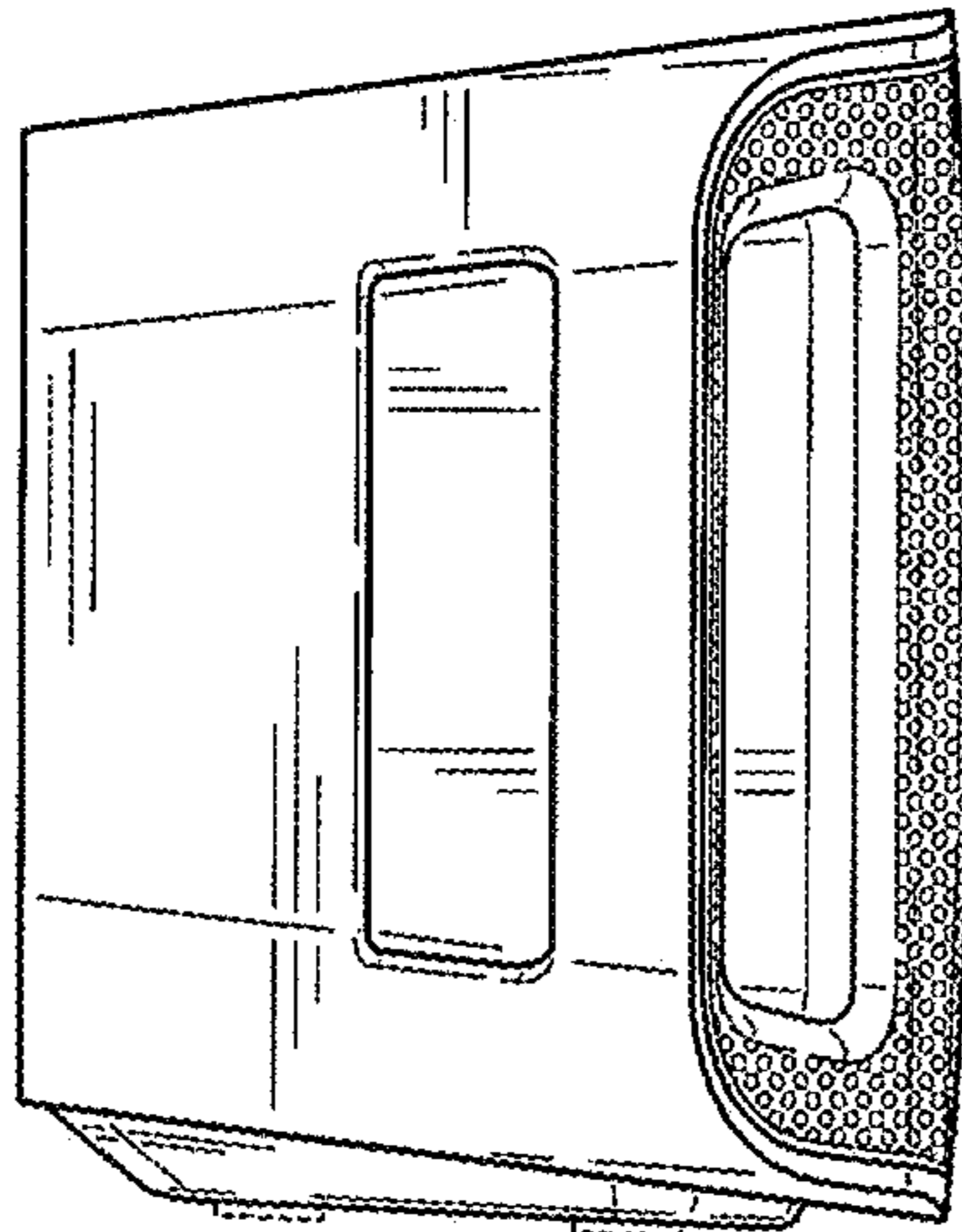

FIG. 5

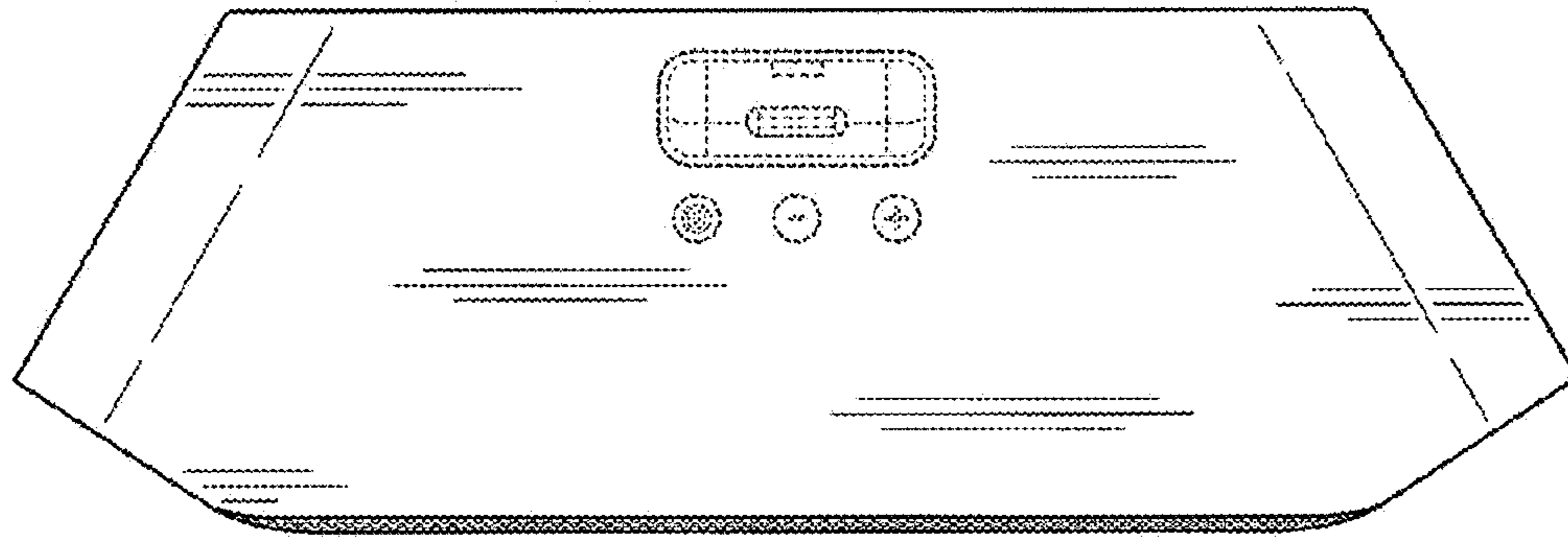

FIG. 6

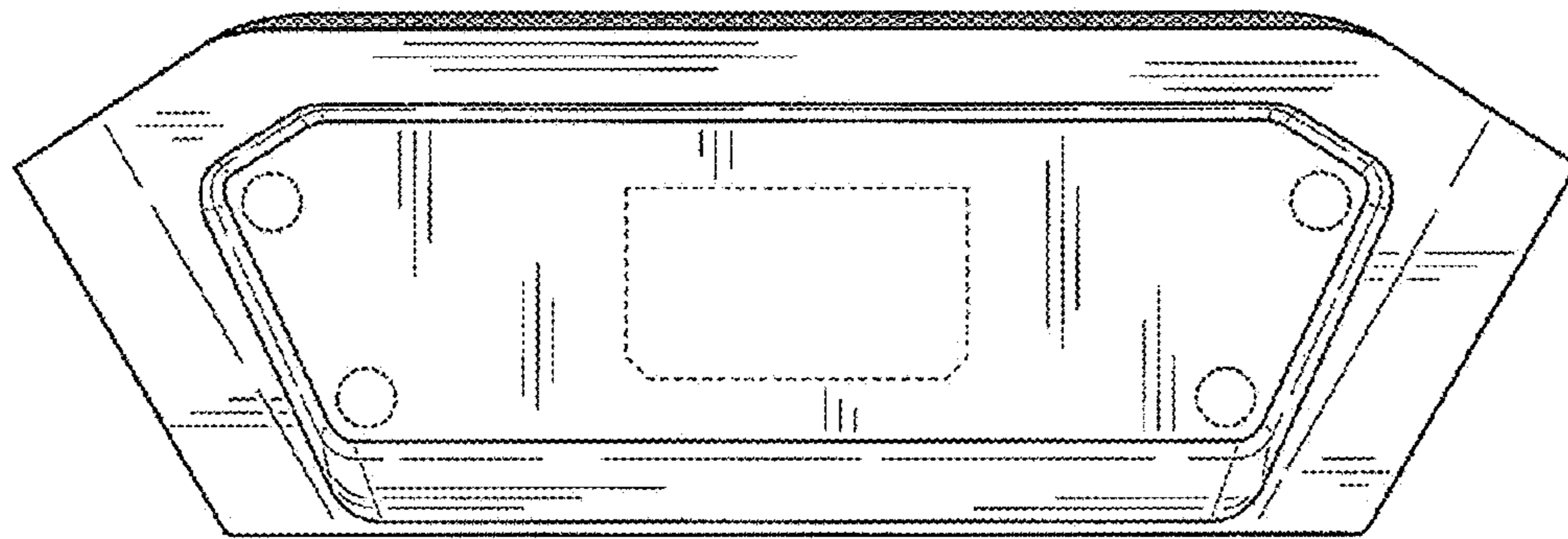

FIG. 7

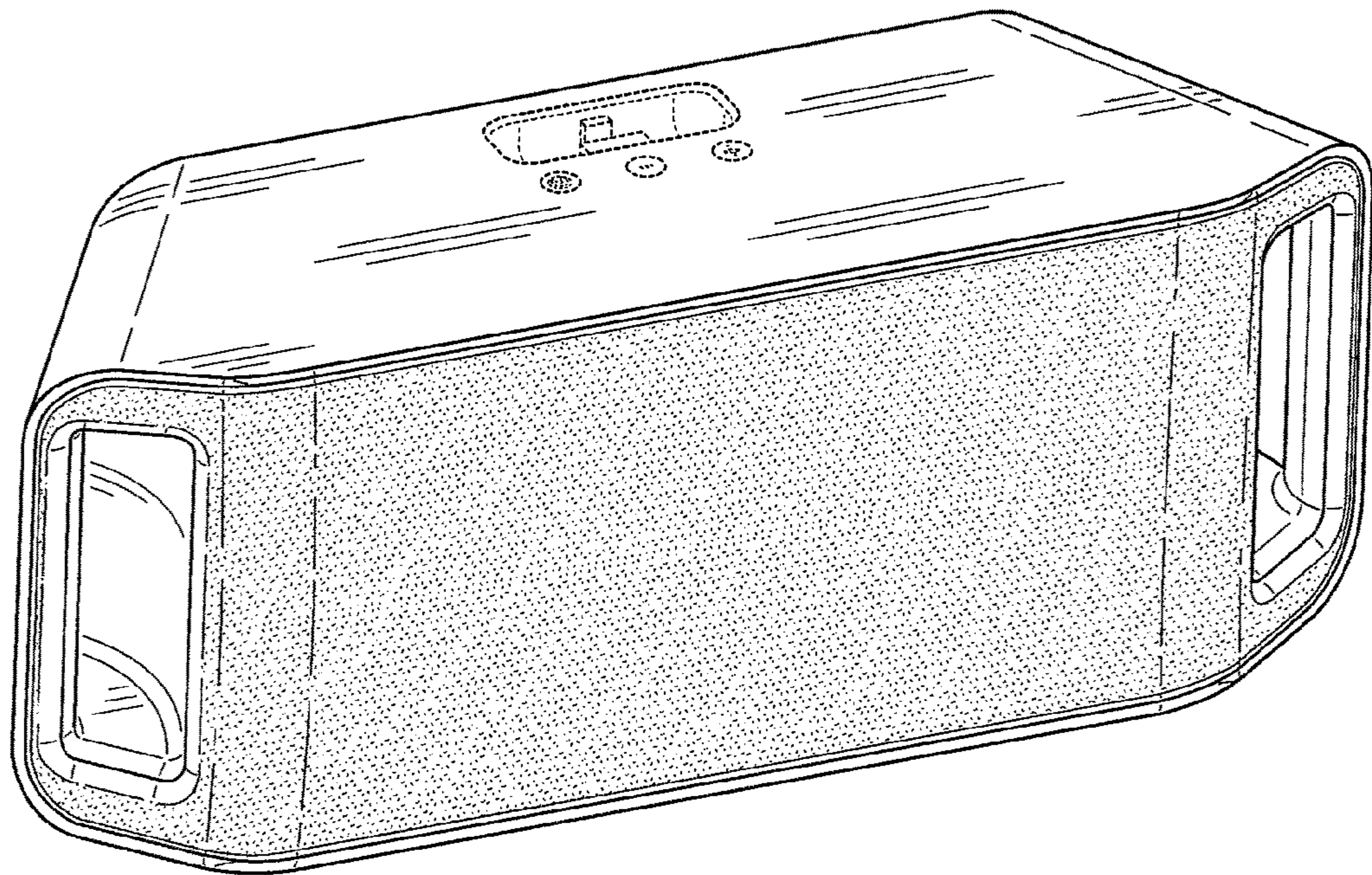

FIG. 8

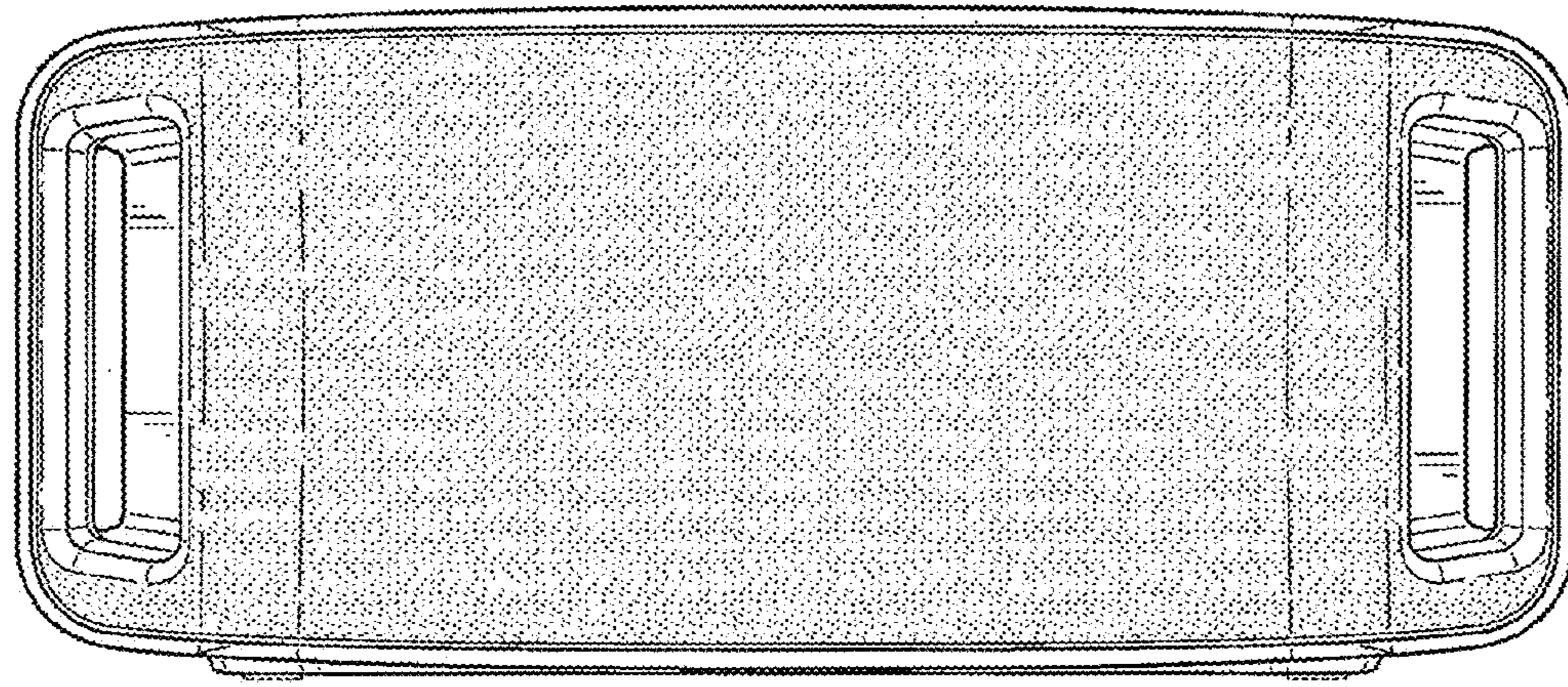

FIG. 9

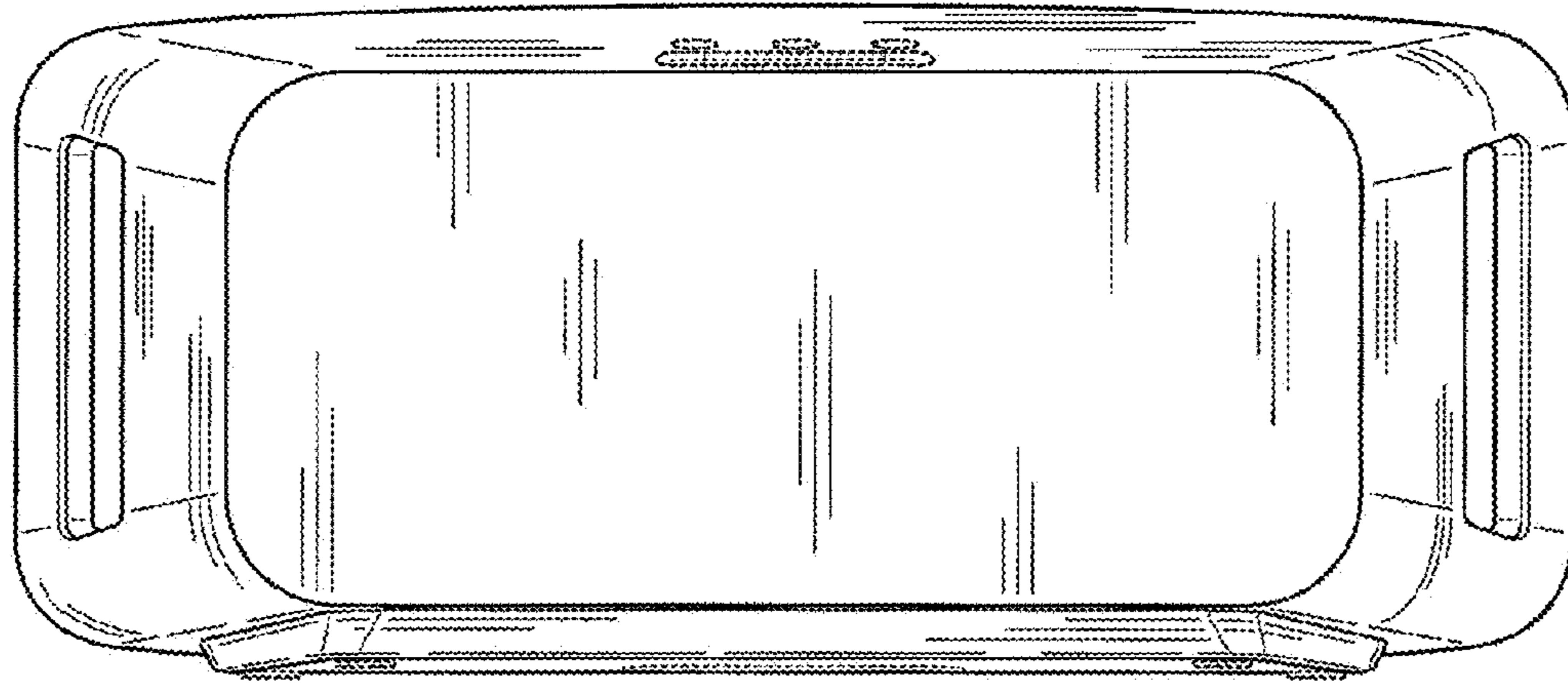

FIG. 10

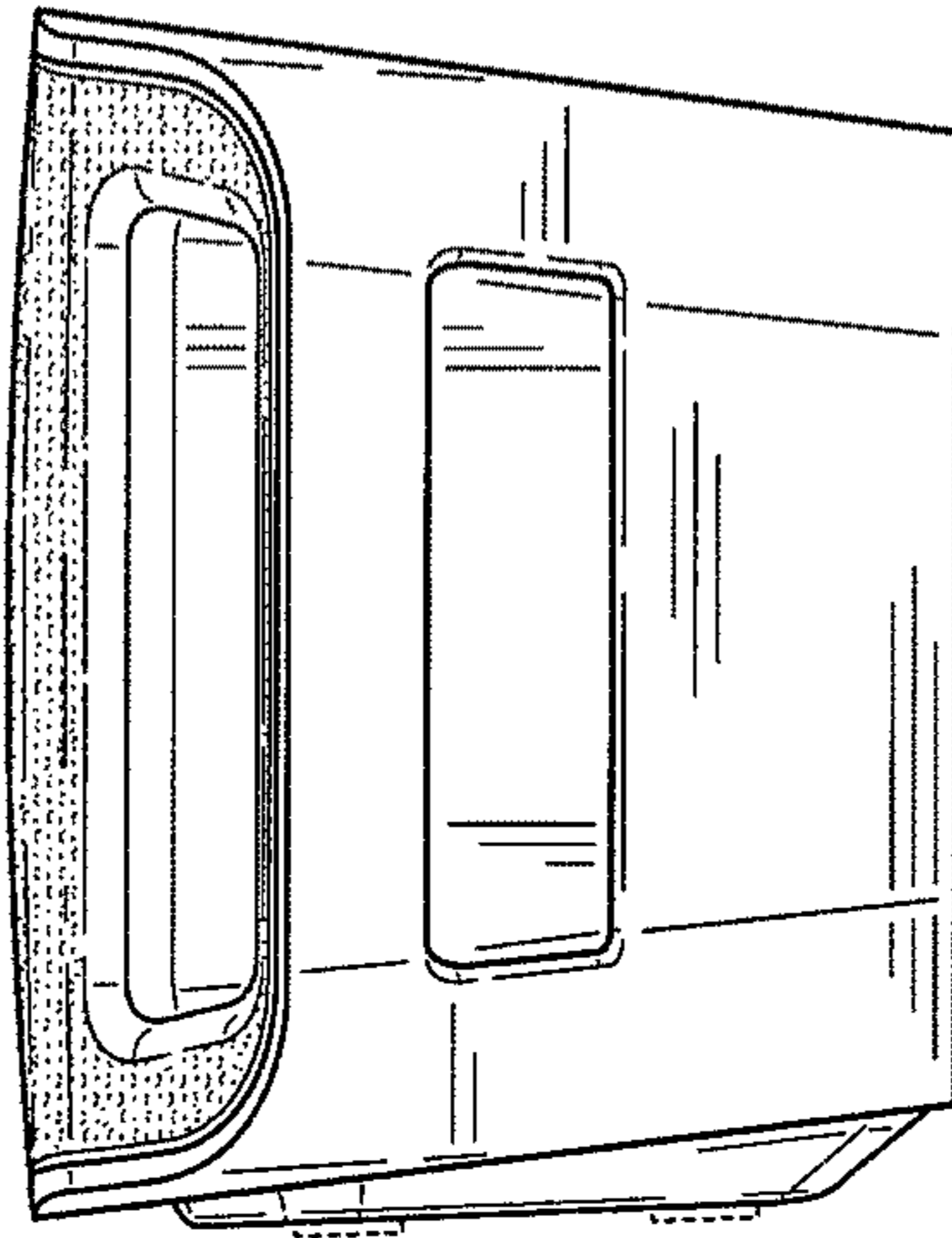

FIG. 11

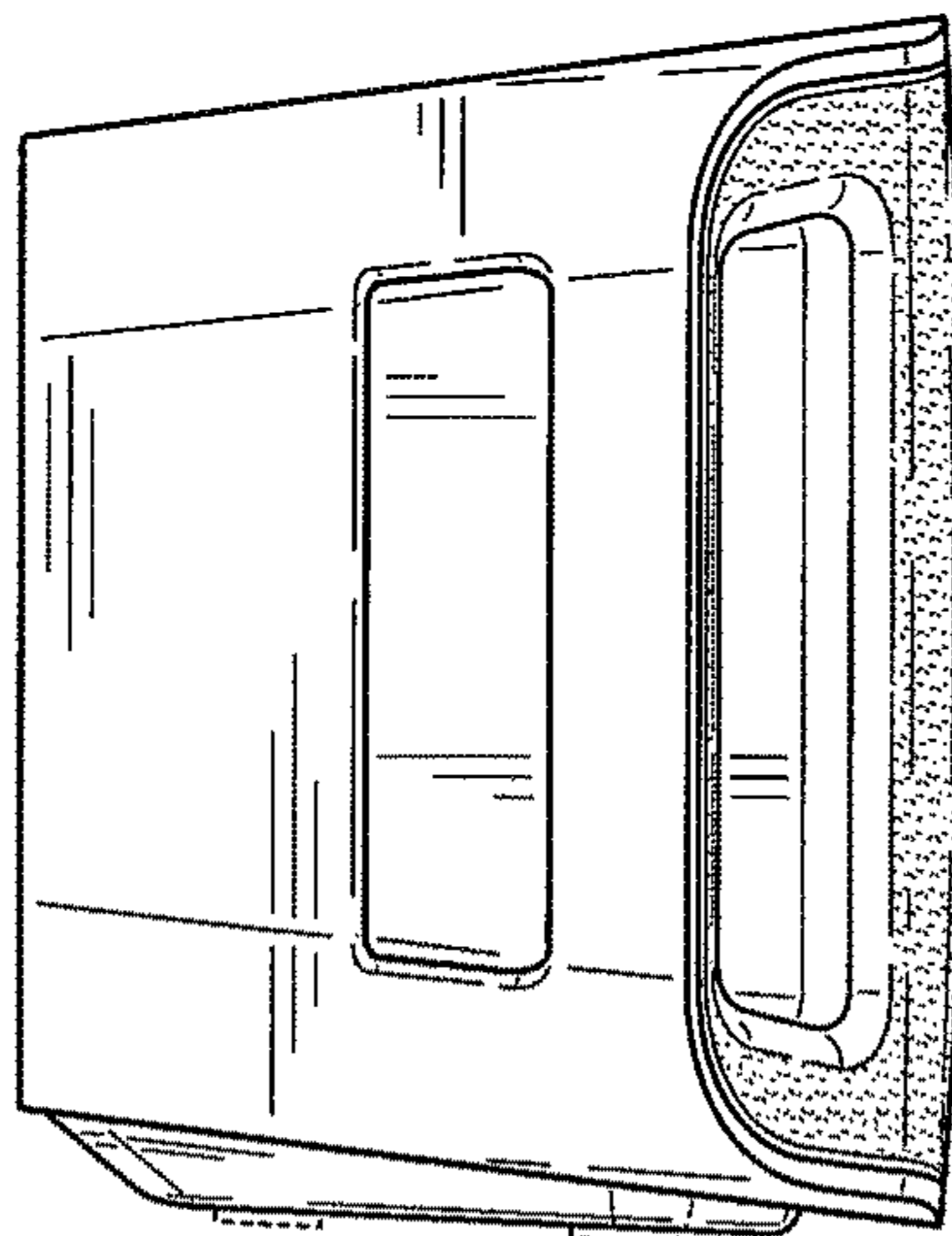

FIG. 12

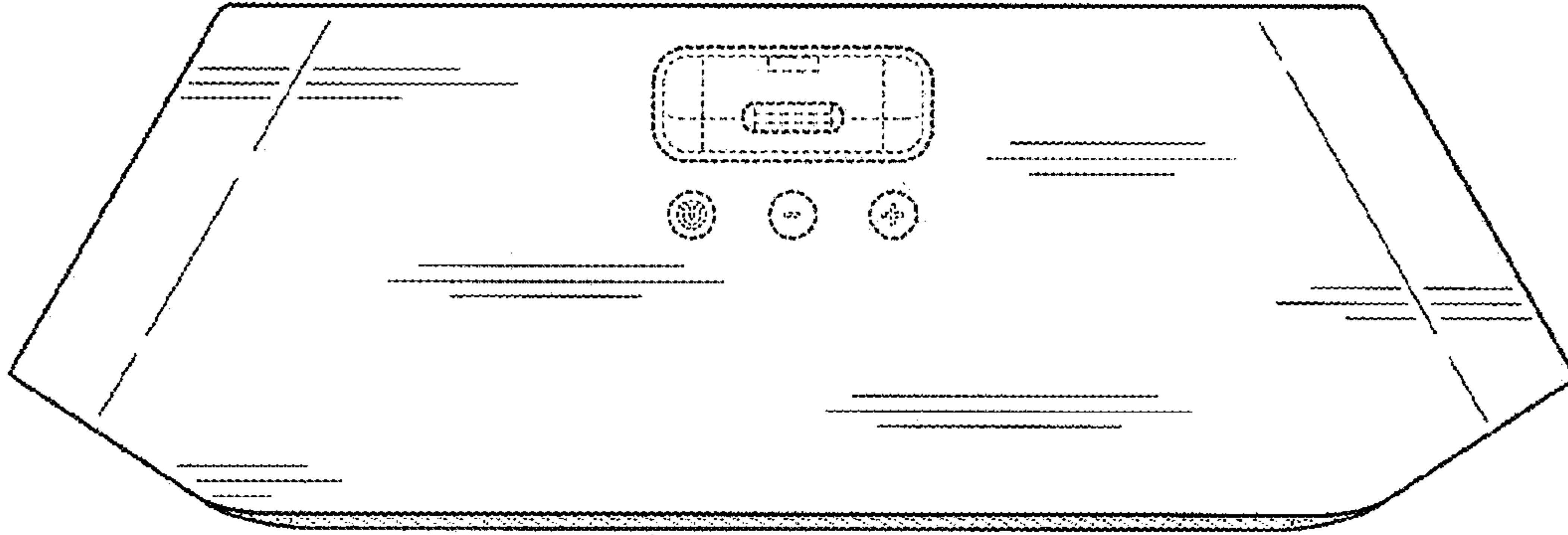

FIG. 13

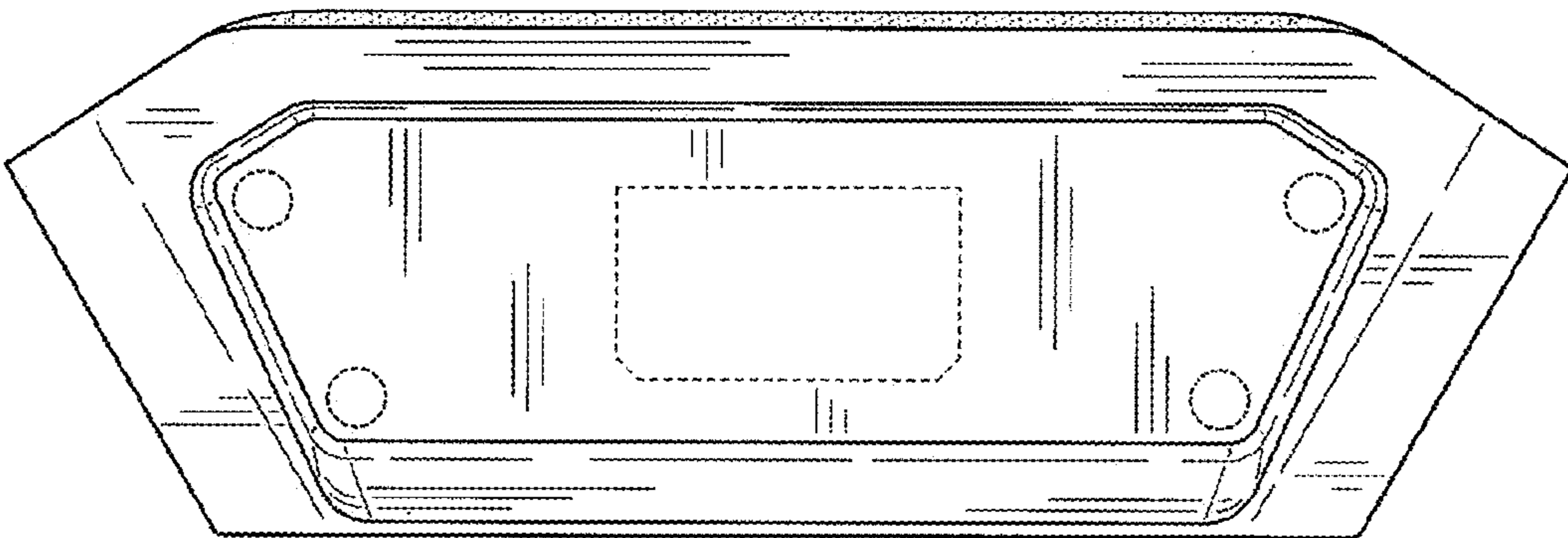

FIG. 14

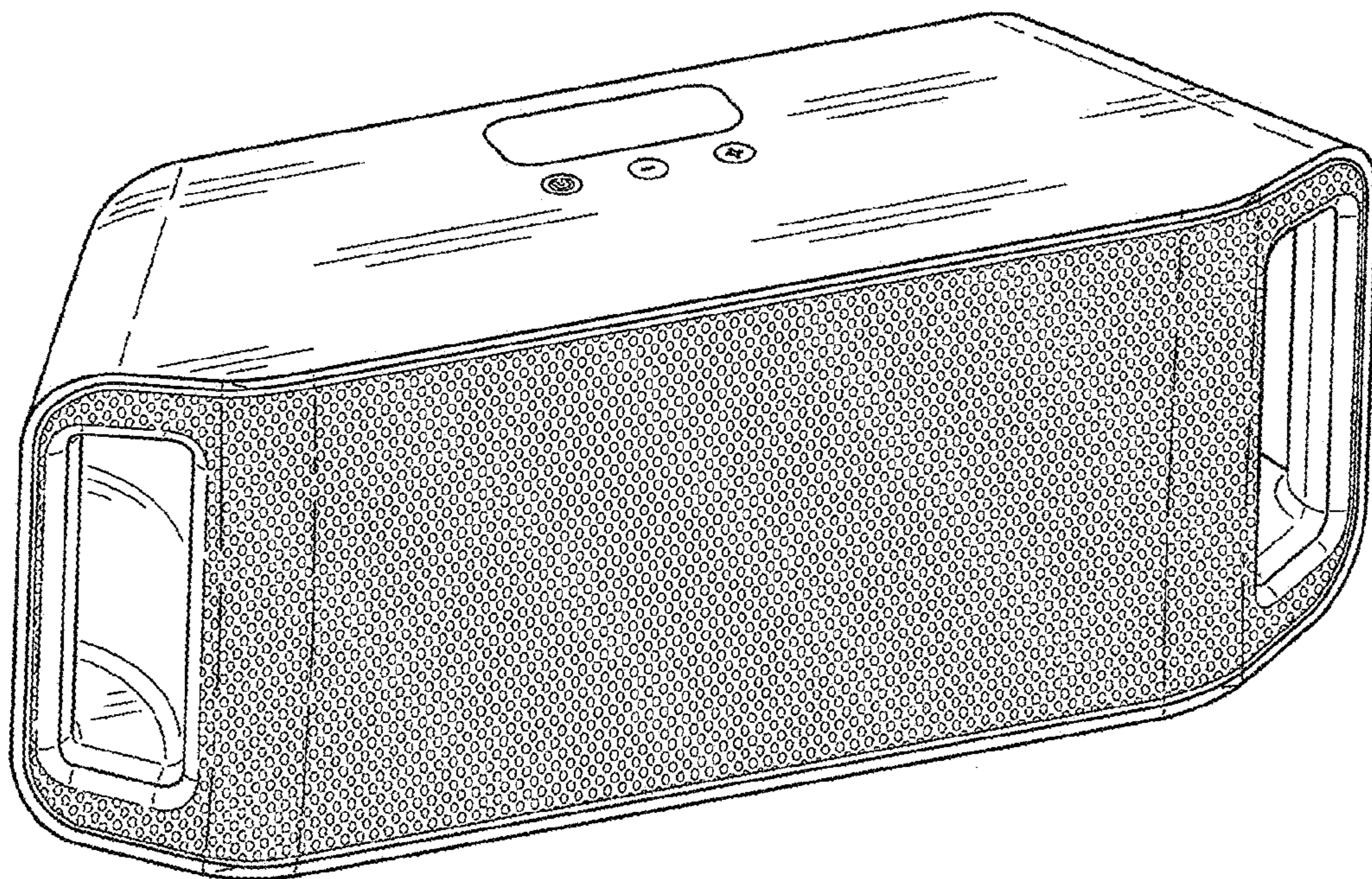

FIG. 15

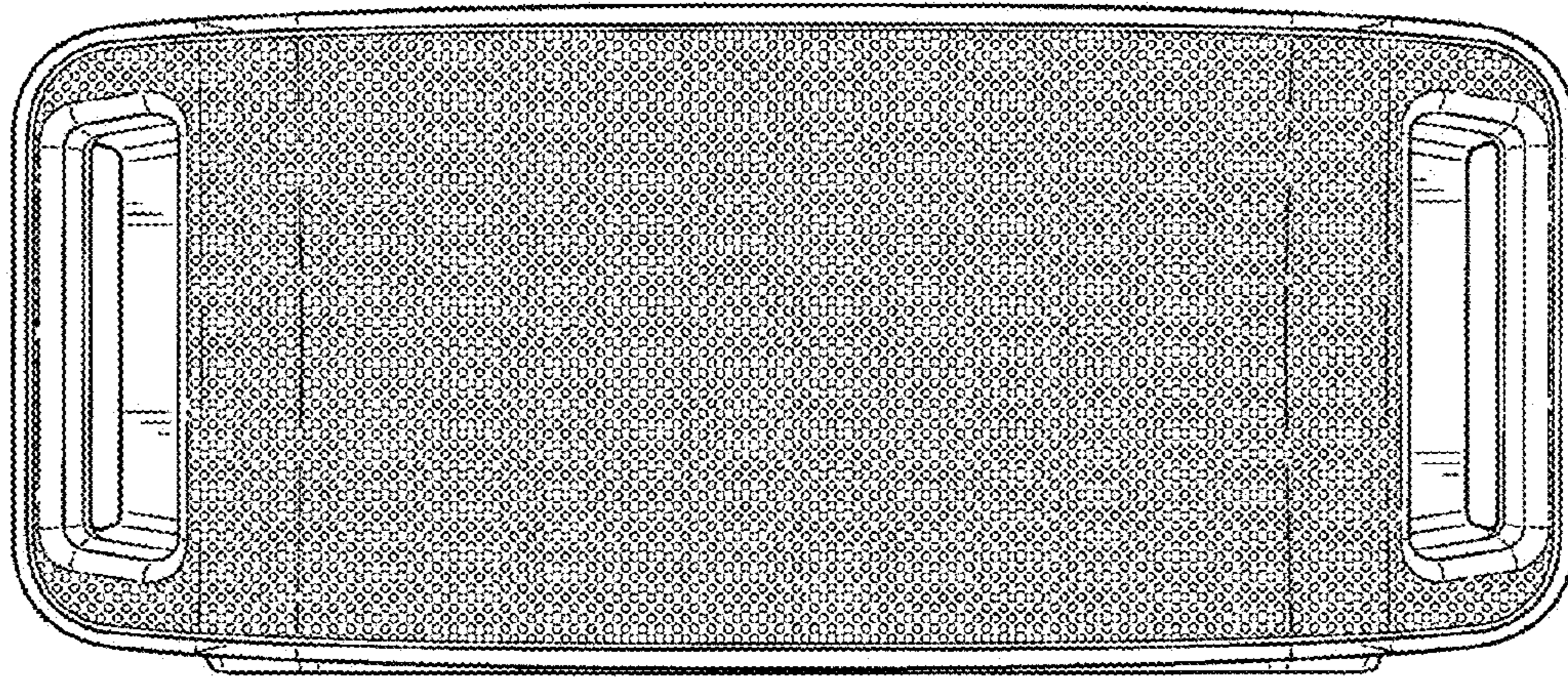

FIG. 16

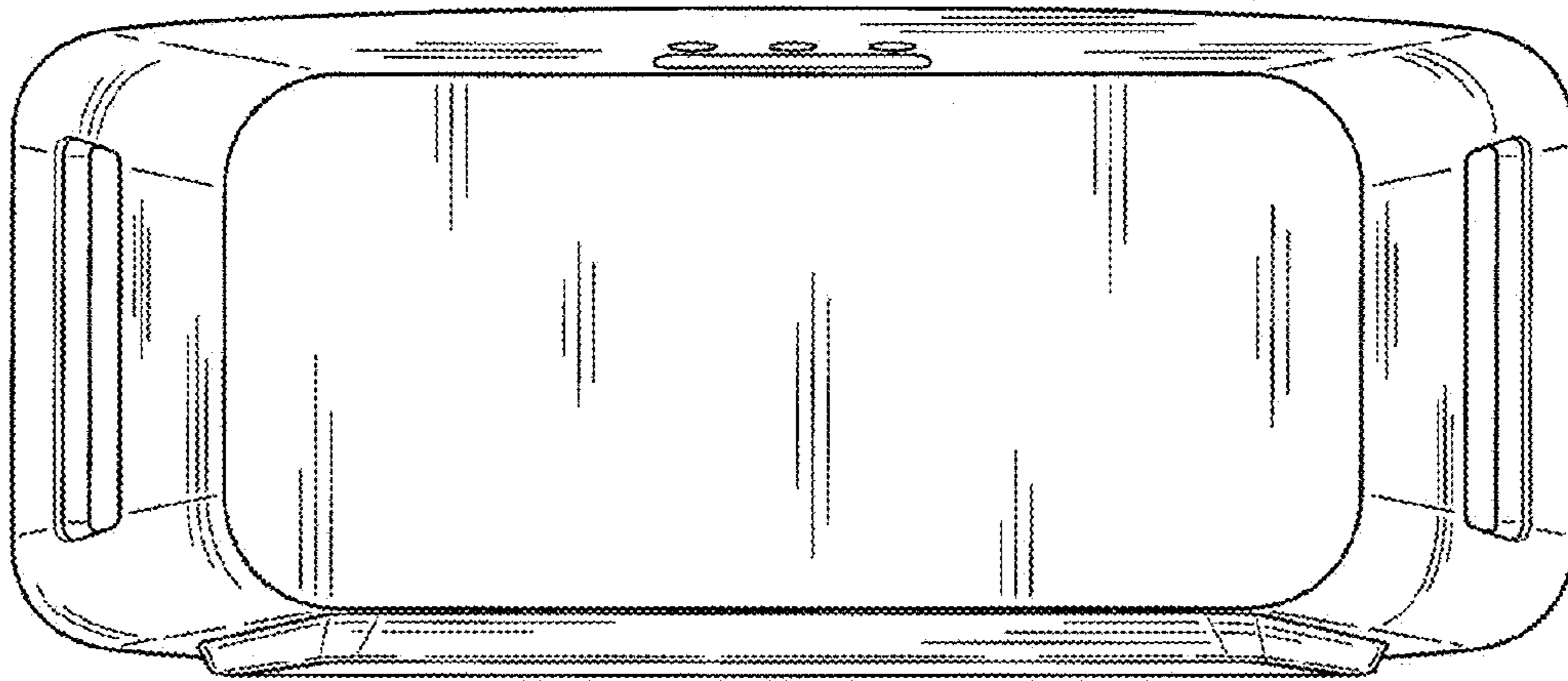

FIG. 17

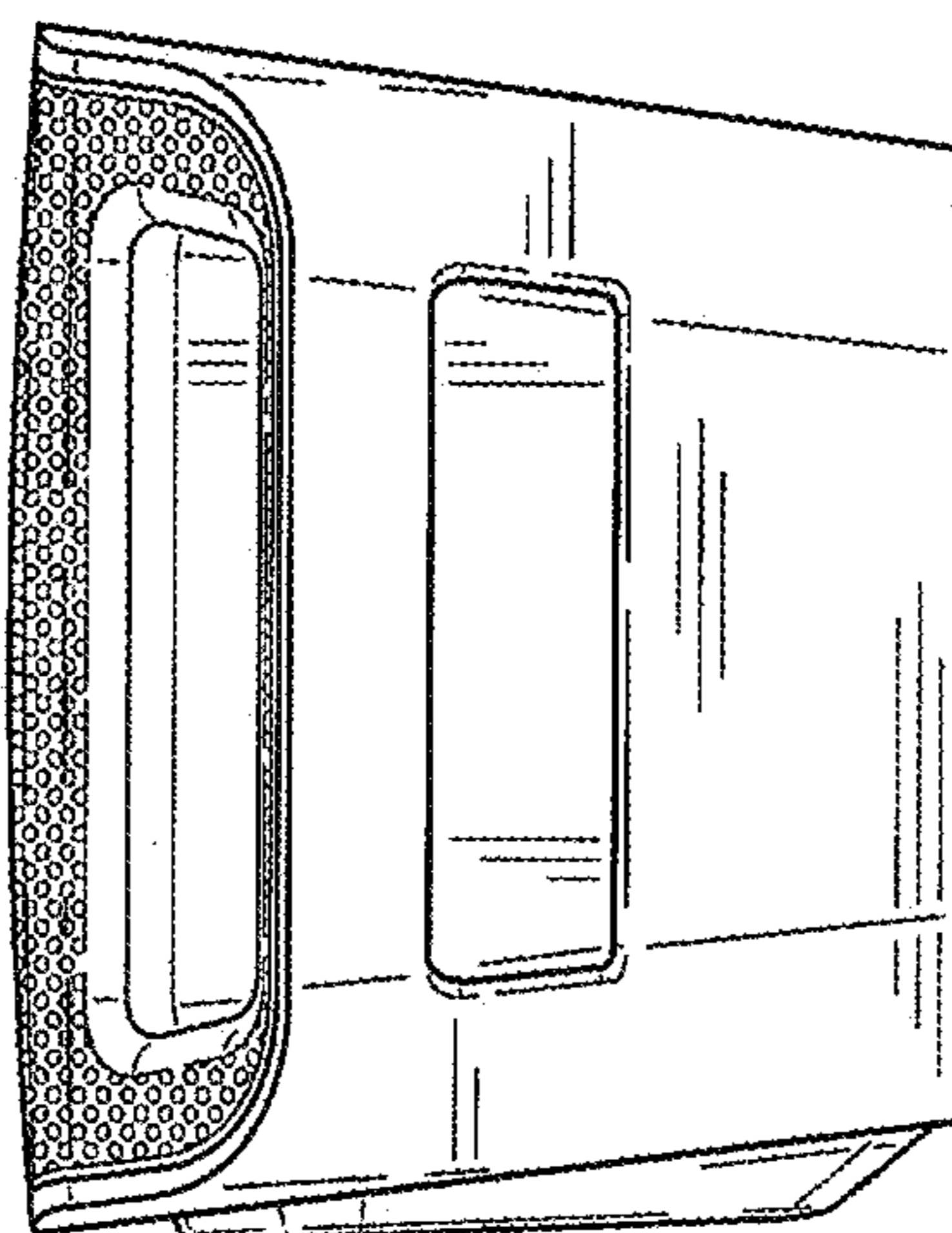

FIG. 18

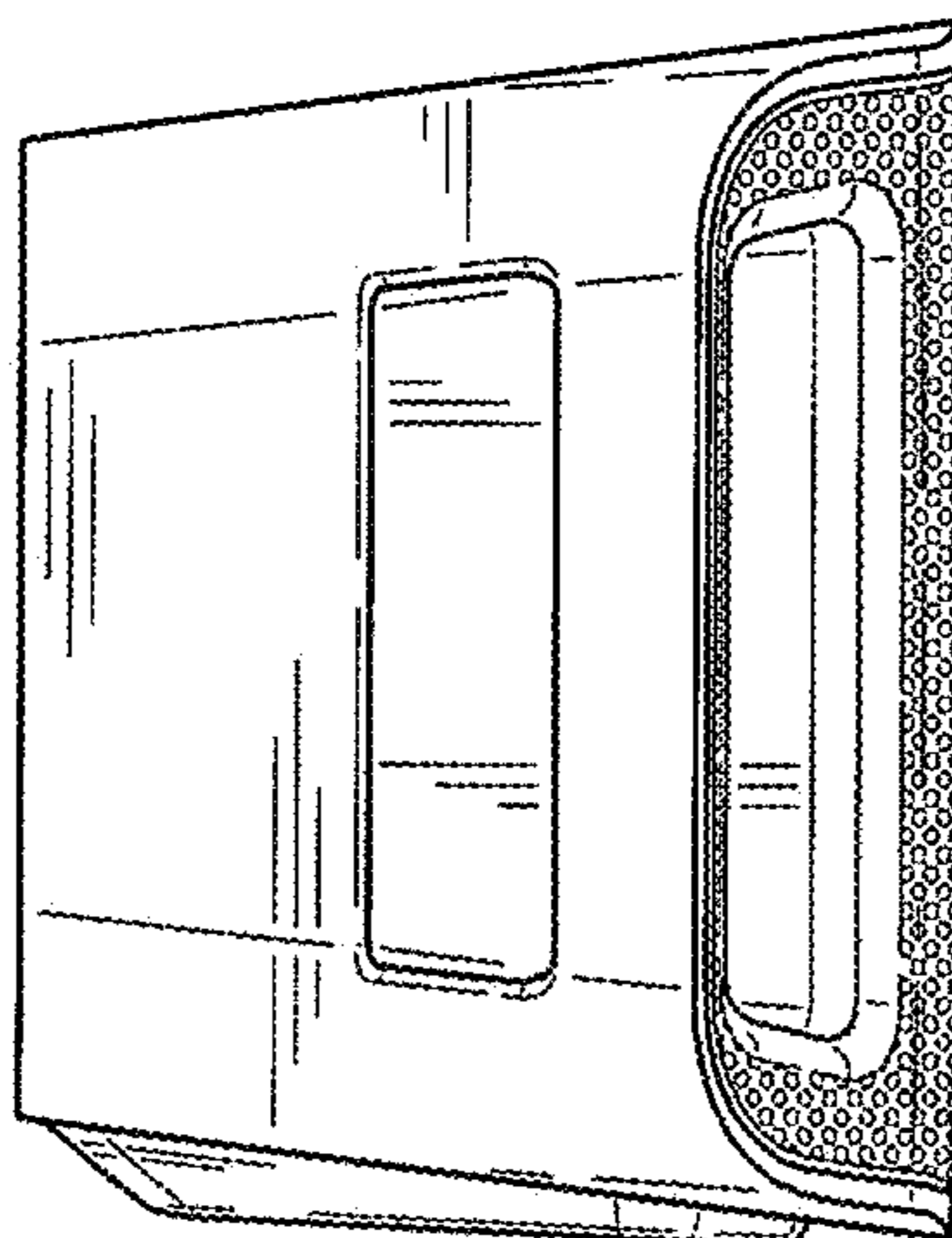

FIG. 19

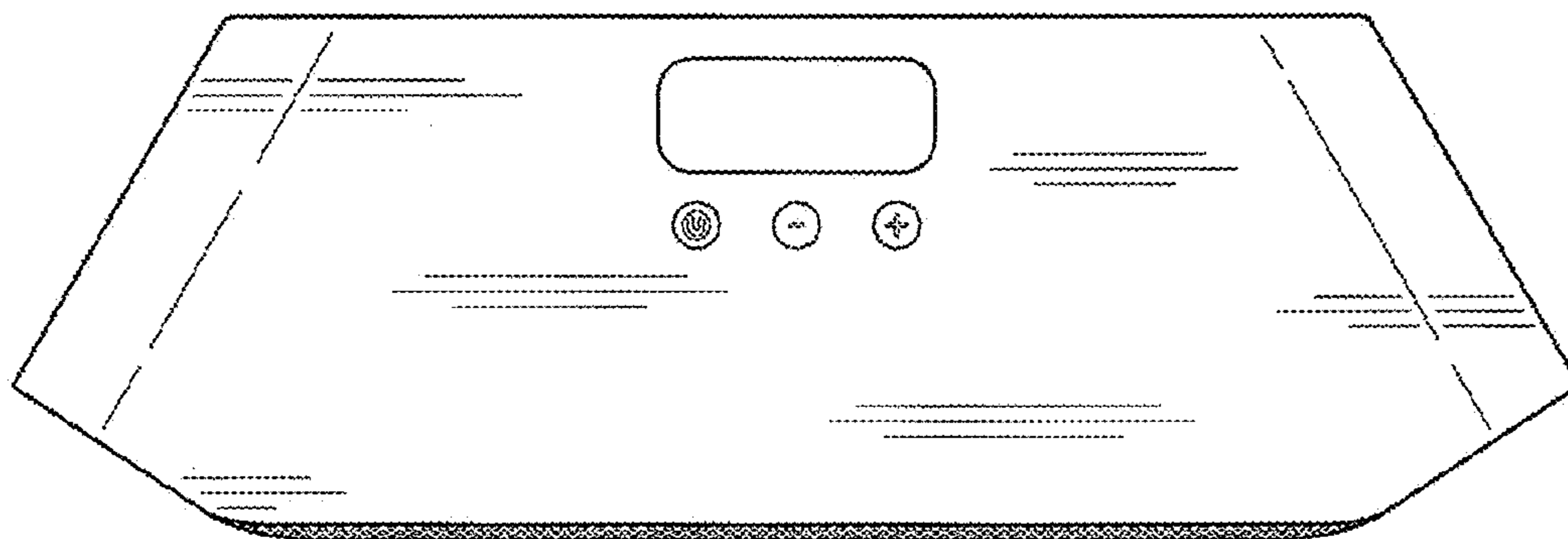

FIG. 20

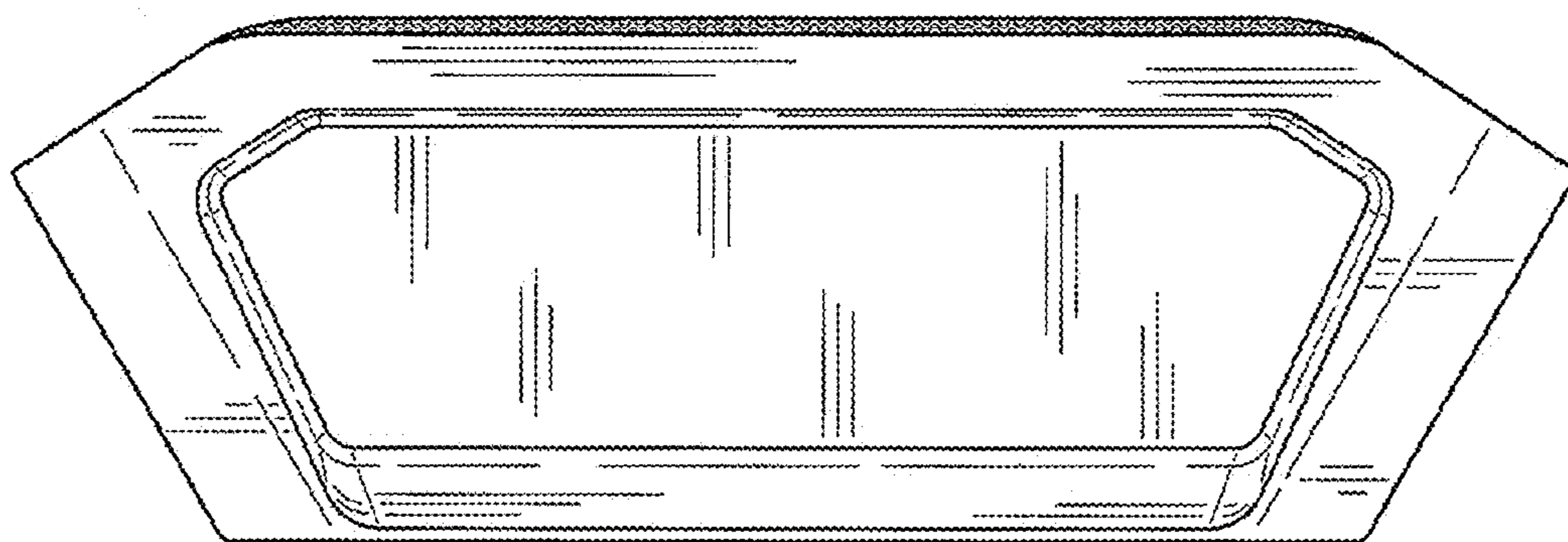

FIG. 21