



US00D683654S

(12) **United States Design Patent**
Andren et al.

(10) **Patent No.:** **US D683,654 S**
(45) **Date of Patent:** **** Jun. 4, 2013**

(54) **COMBINED BUCKLE**

(75) Inventors: **Mårten Andren**, Spånga (SE); **Thomas Bergens**, Ingarö (SE); **Jakob Wikner**, Täby (SE)

(73) Assignee: **BabyBjörn AB**, Solna (SE)

(**) **Term:** **14 Years**

(21) Appl. No.: **29/426,962**

(22) Filed: **Jul. 12, 2012**

(51) **LOC (9) Cl.** **02-07**

(52) **U.S. Cl.**
USPC **D11/216**

(58) **Field of Classification Search**
USPC D11/1-2, 200-201, 206-210, 214-218;
24/163 R, 169-171, 173, 177-179, 191,
194-195, 197, 200, 614-616, 625, 198
See application file for complete search history.

(56) **References Cited**

U.S. PATENT DOCUMENTS

D327,455 S *	6/1992	Blair	D11/216
D333,640 S *	3/1993	Keller	D11/218
D508,872 S *	8/2005	Hoepfner	D11/216
D567,709 S *	4/2008	Cho	D11/216
D600,160 S *	9/2009	Kosh et al.	D11/218
D603,753 S *	11/2009	Palmer et al.	D11/216
D625,656 S *	10/2010	Kosh et al.	D11/216

* cited by examiner

Primary Examiner — Ralf Seifert

(74) *Attorney, Agent, or Firm* — Jacobson Holman PLLC

(57) **CLAIM**

The ornamental design for a combined buckle, as shown and described.

DESCRIPTION

FIG. 1 is a perspective view showing our new design for a combined buckle,
FIG. 2 is a top view thereof,
FIG. 3 is a bottom view thereof,
FIG. 4 is a right side view thereof,
FIG. 5 is a left side view thereof,
FIG. 6 is a rear view thereof,
FIG. 7 is a front view thereof,
FIG. 8 is a perspective view showing the separated buckle elements,
FIG. 9 is a top view thereof,
FIG. 10 is a bottom view thereof,
FIG. 11 is a right side view thereof,
FIG. 12 is a left side view thereof,
FIG. 13 is a rear view thereof; and,
FIG. 14 is a front view thereof.

1 Claim, 14 Drawing Sheets

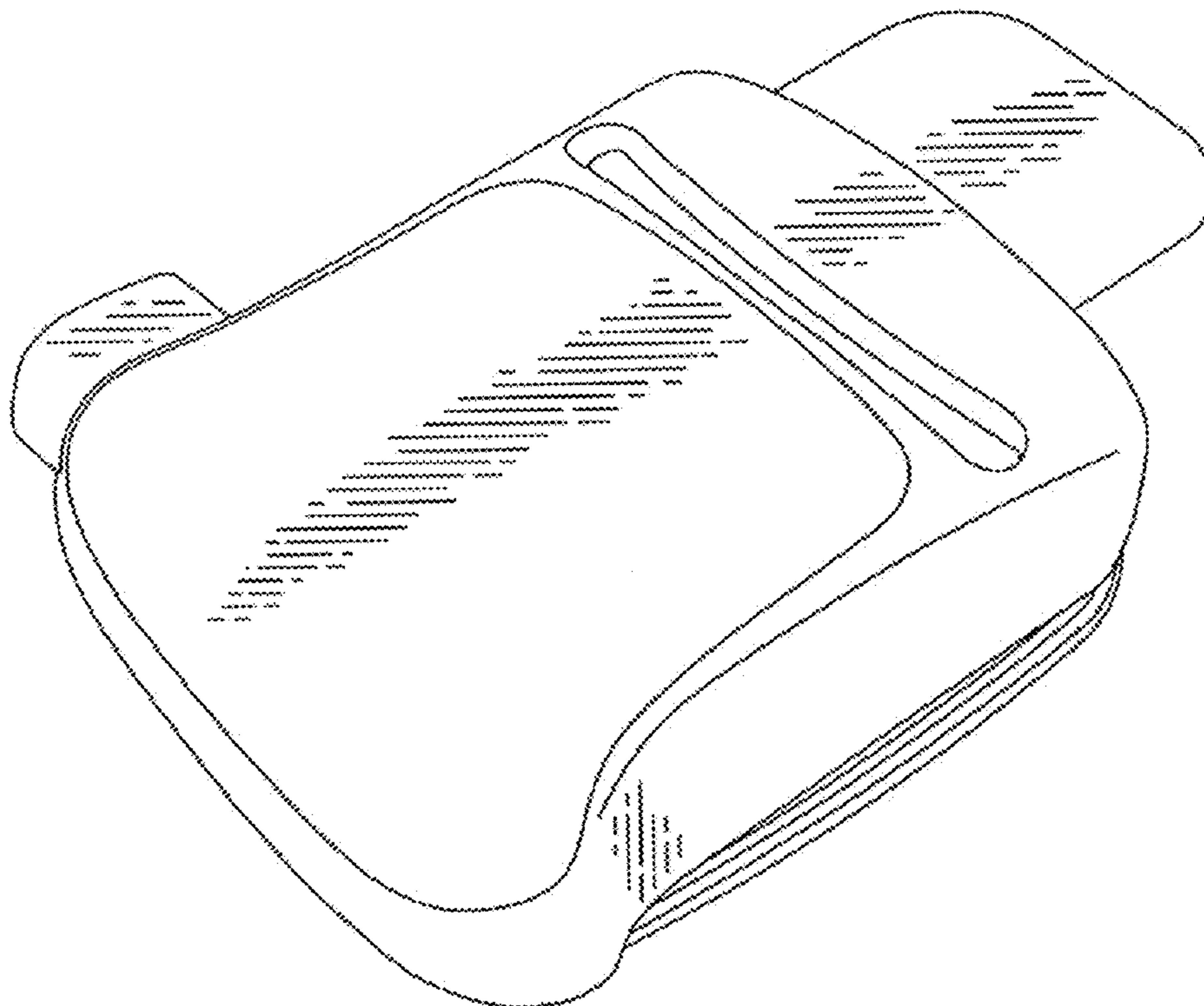

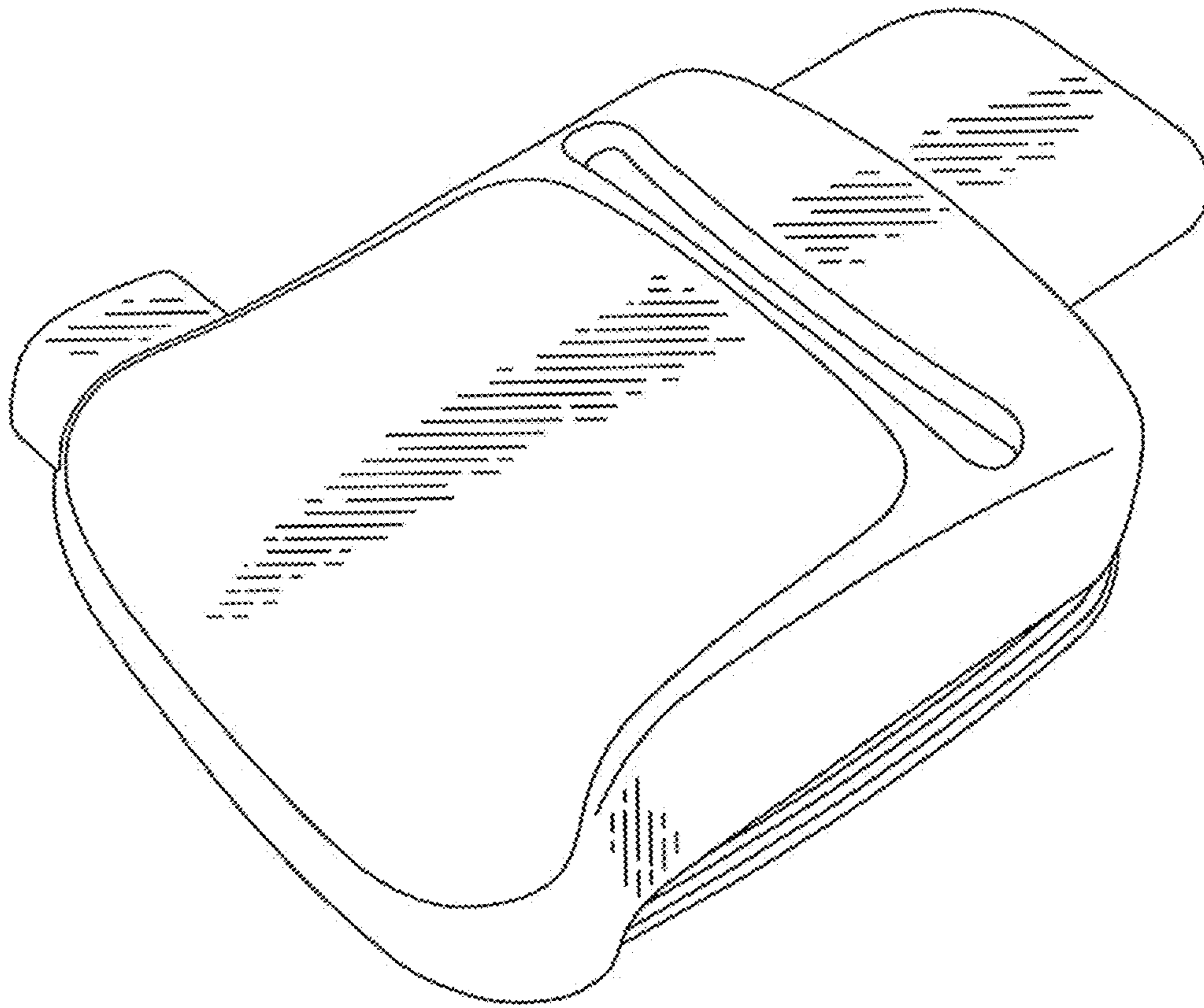

FIGURE 1

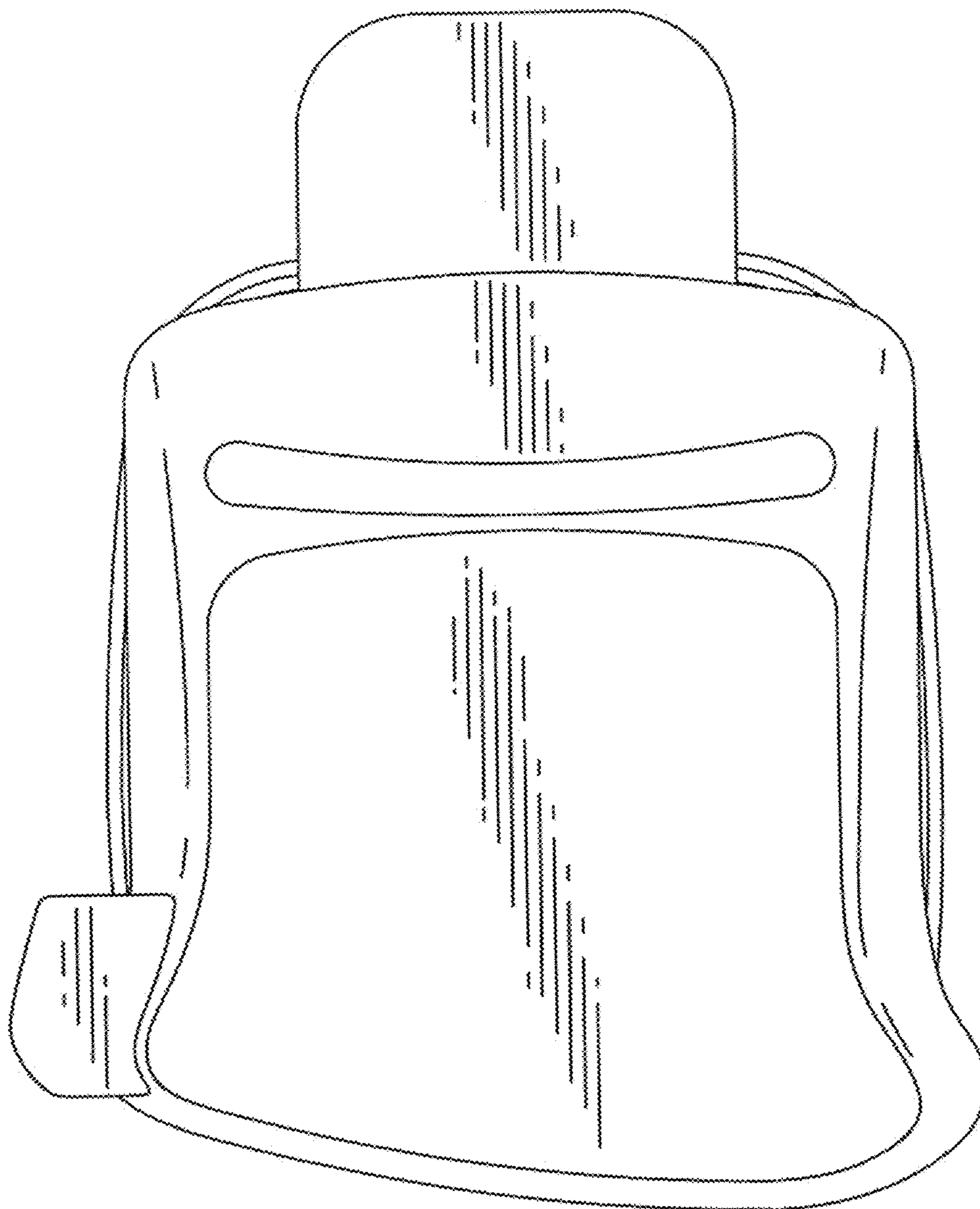

FIGURE 2

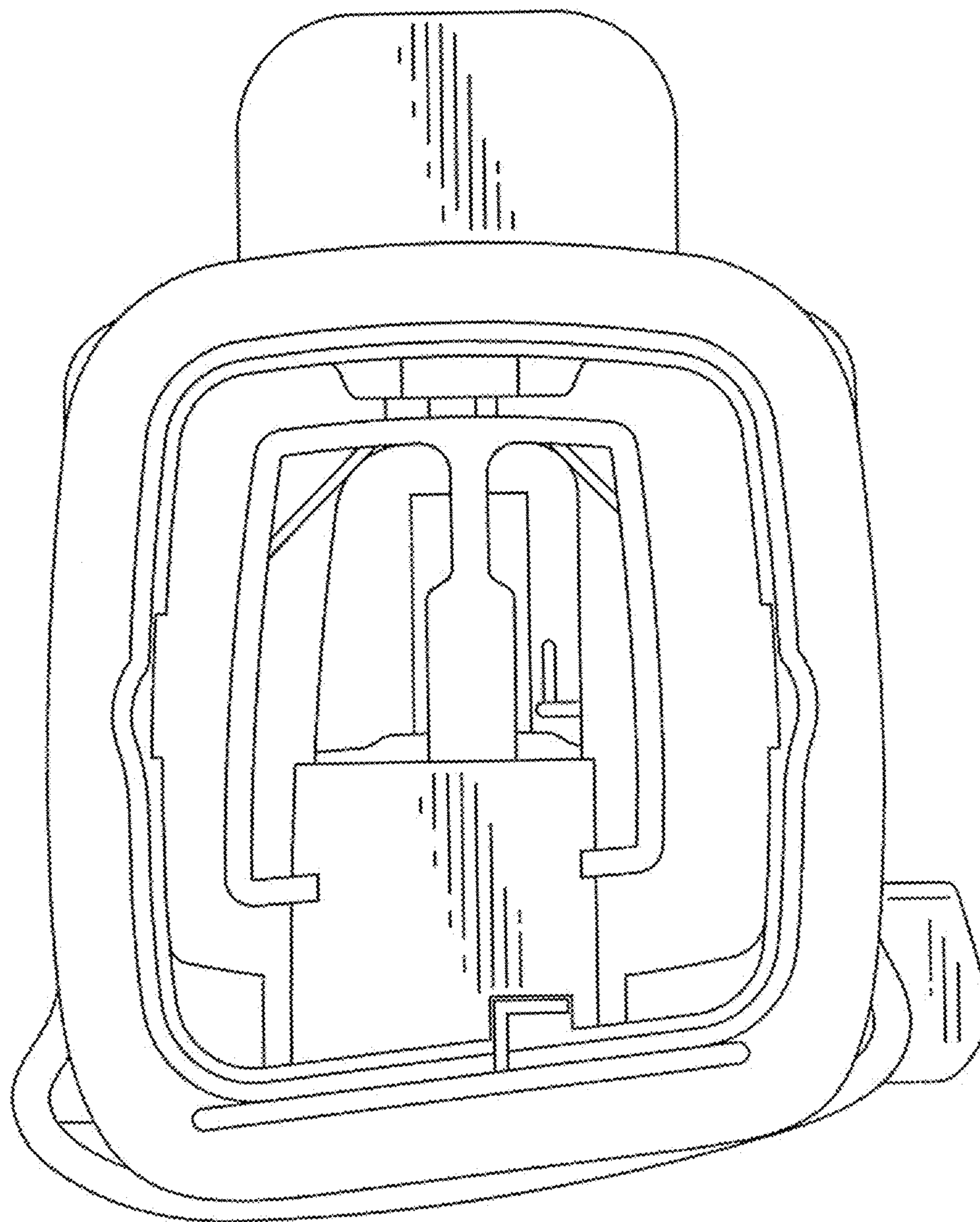

FIGURE 3

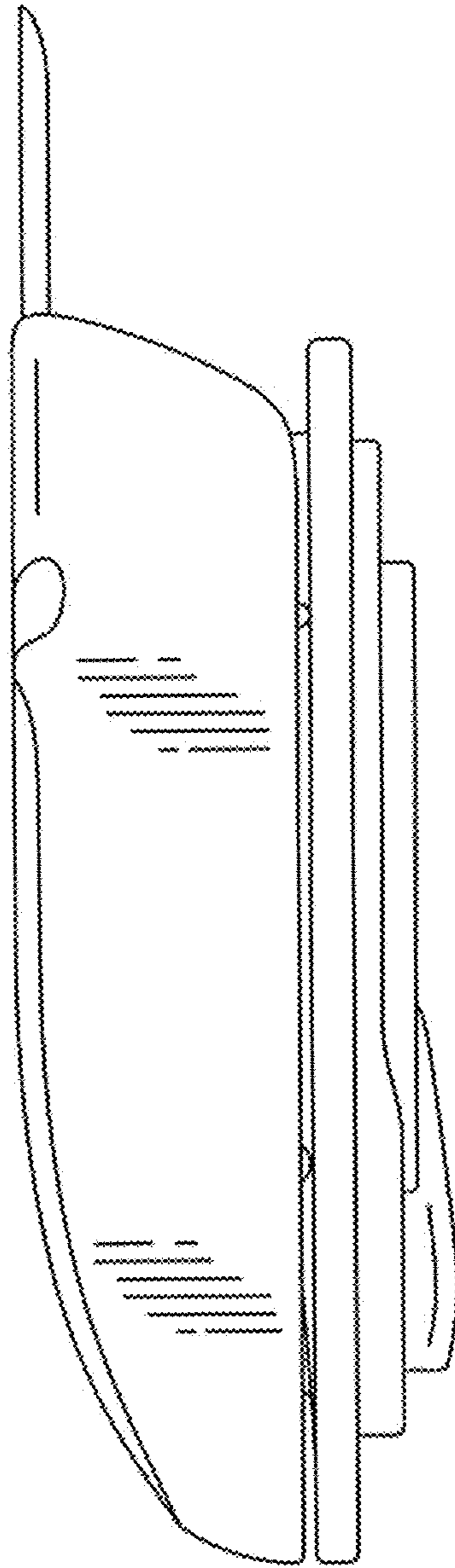

FIGURE 4

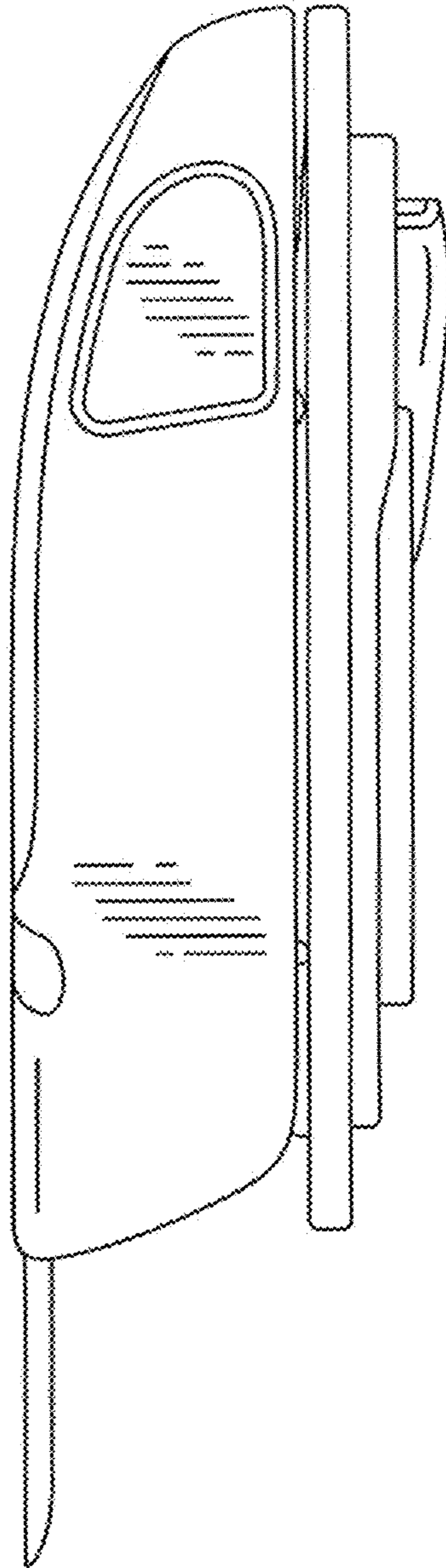

FIGURE 5

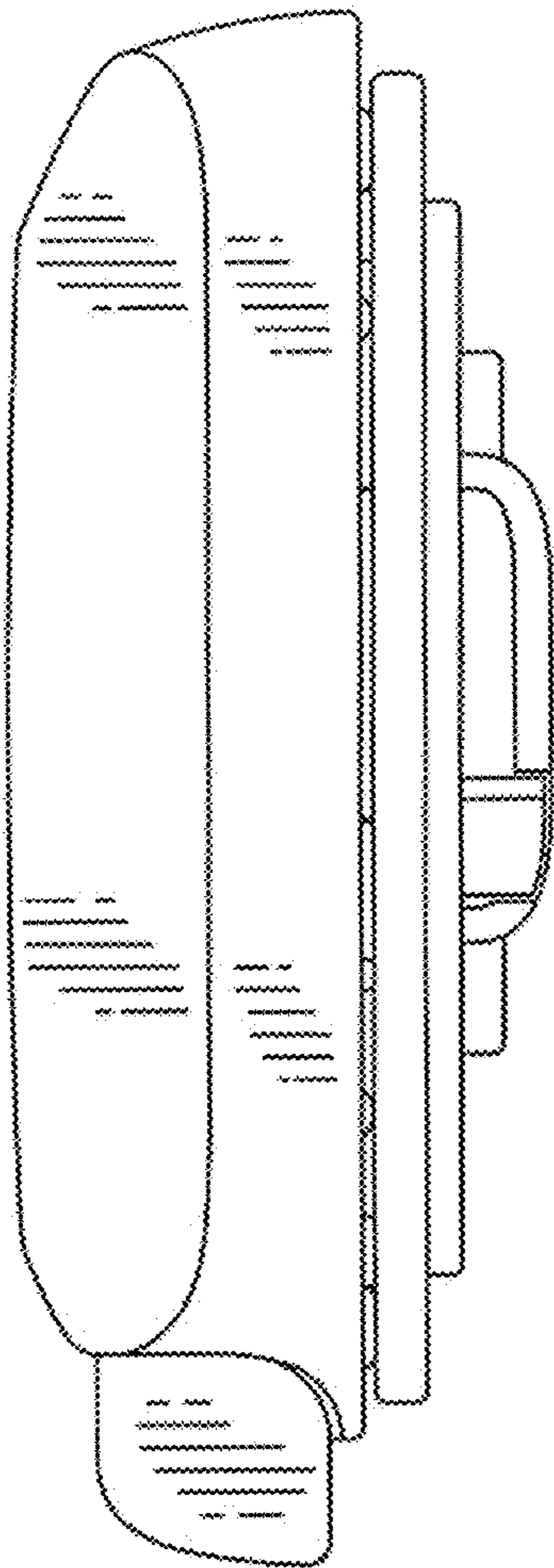

FIGURE 6

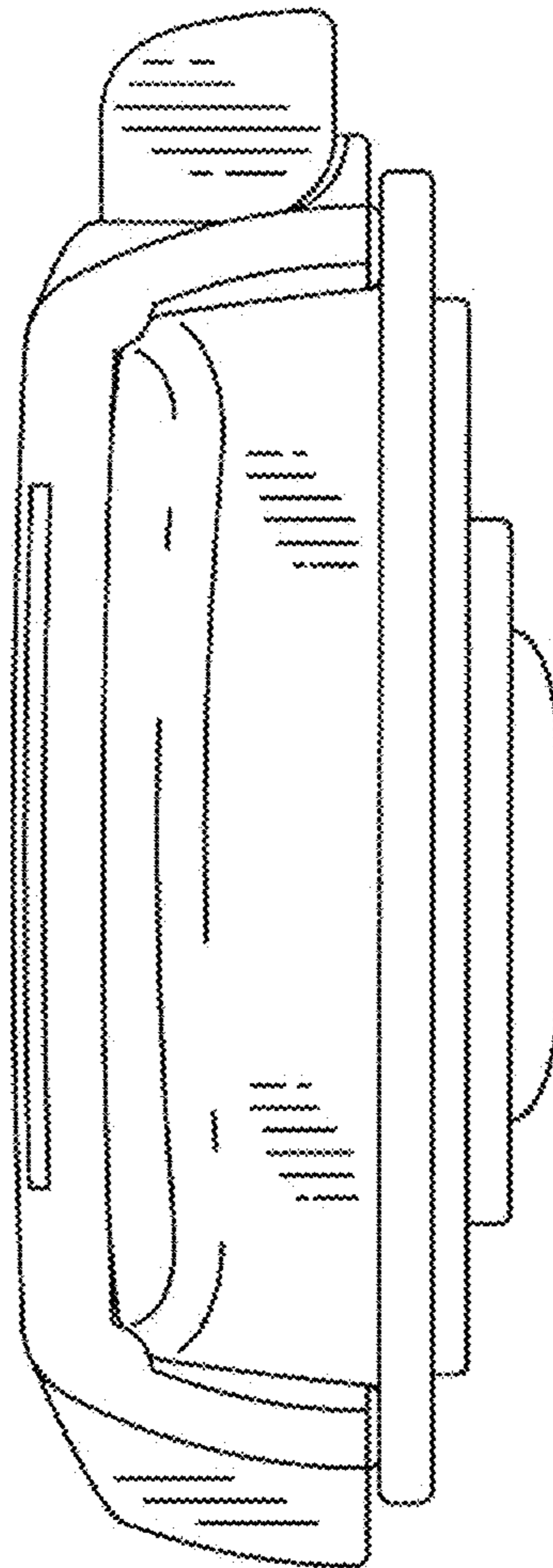

FIGURE 7

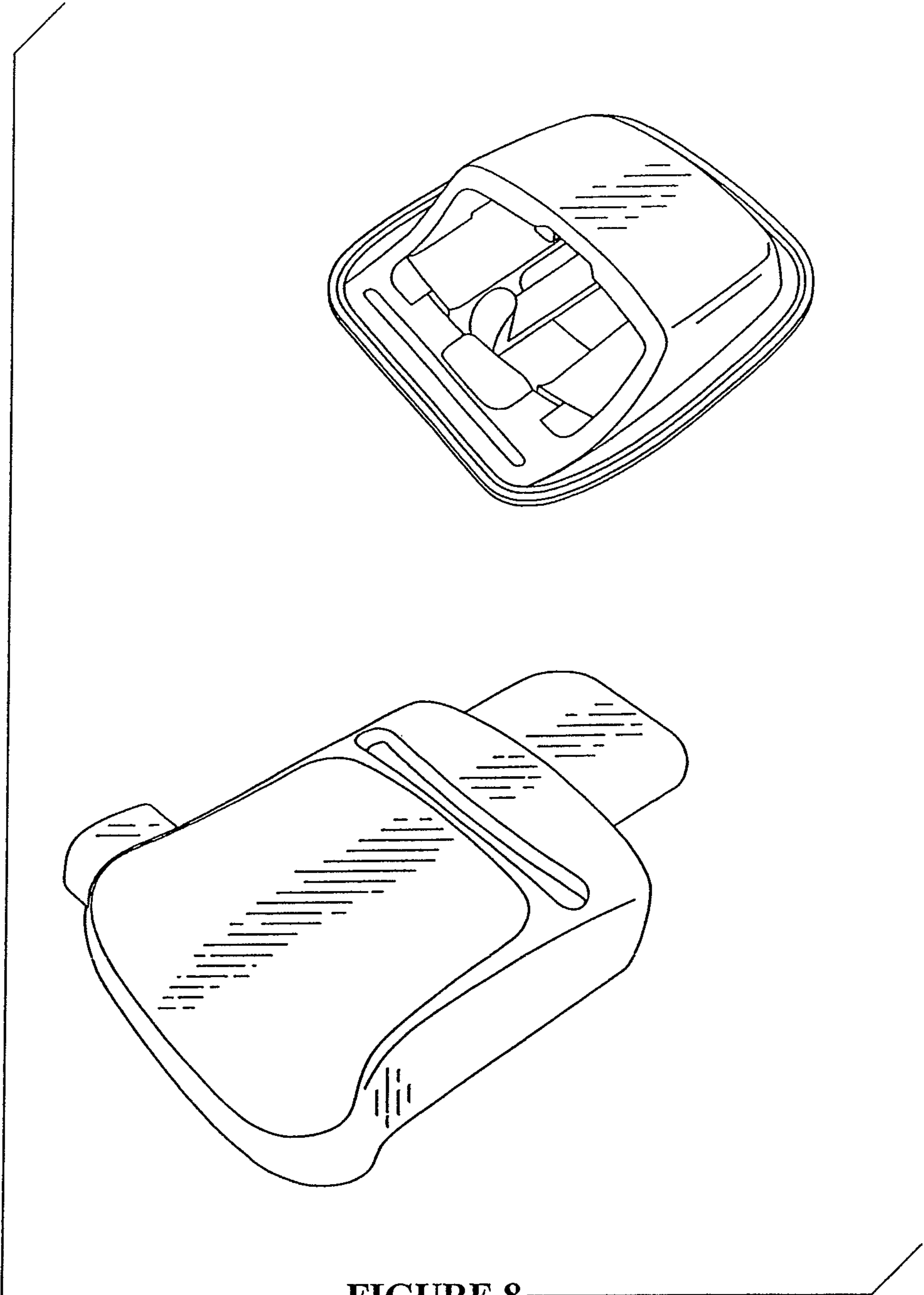

FIGURE 8

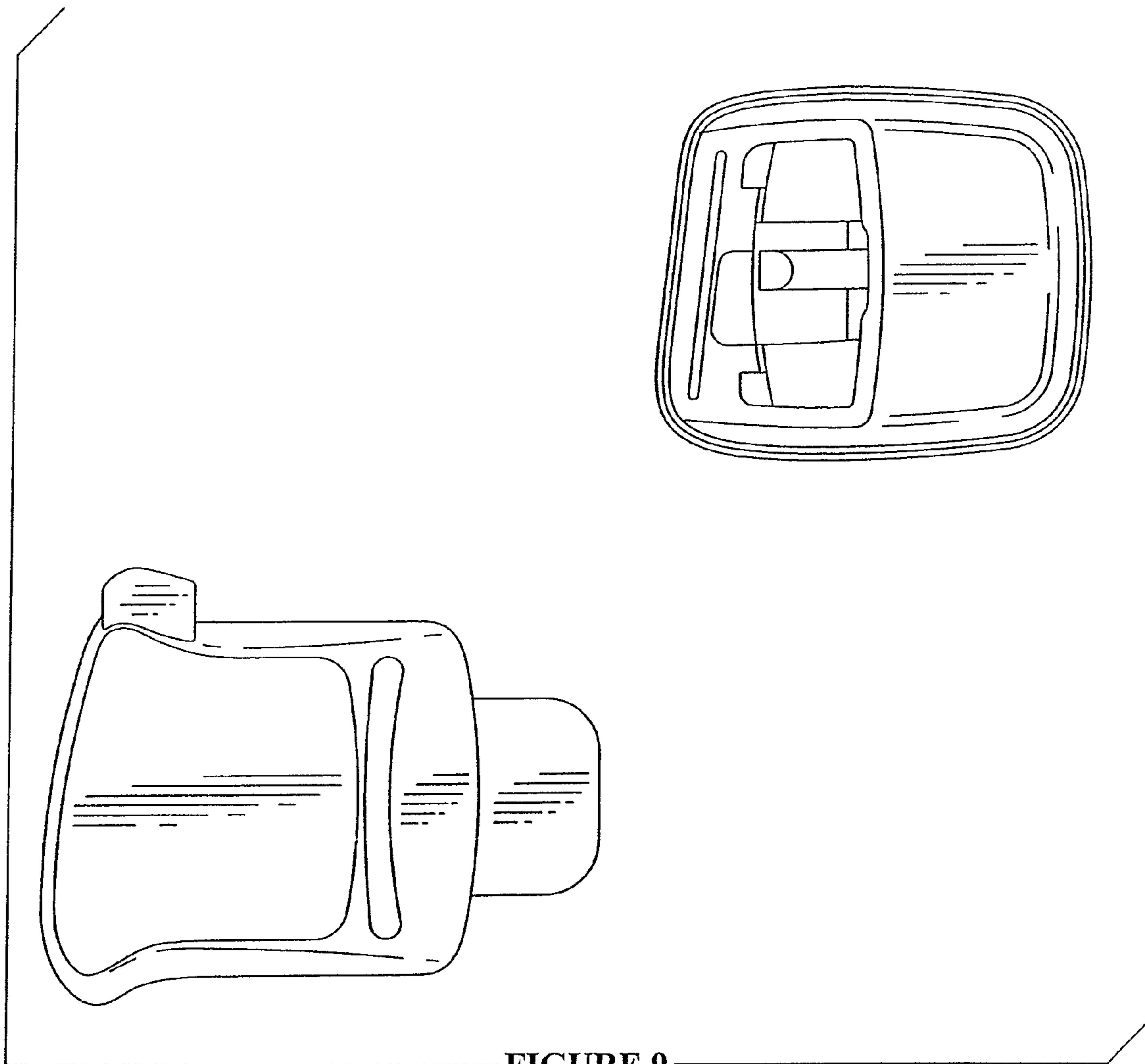

FIGURE 9

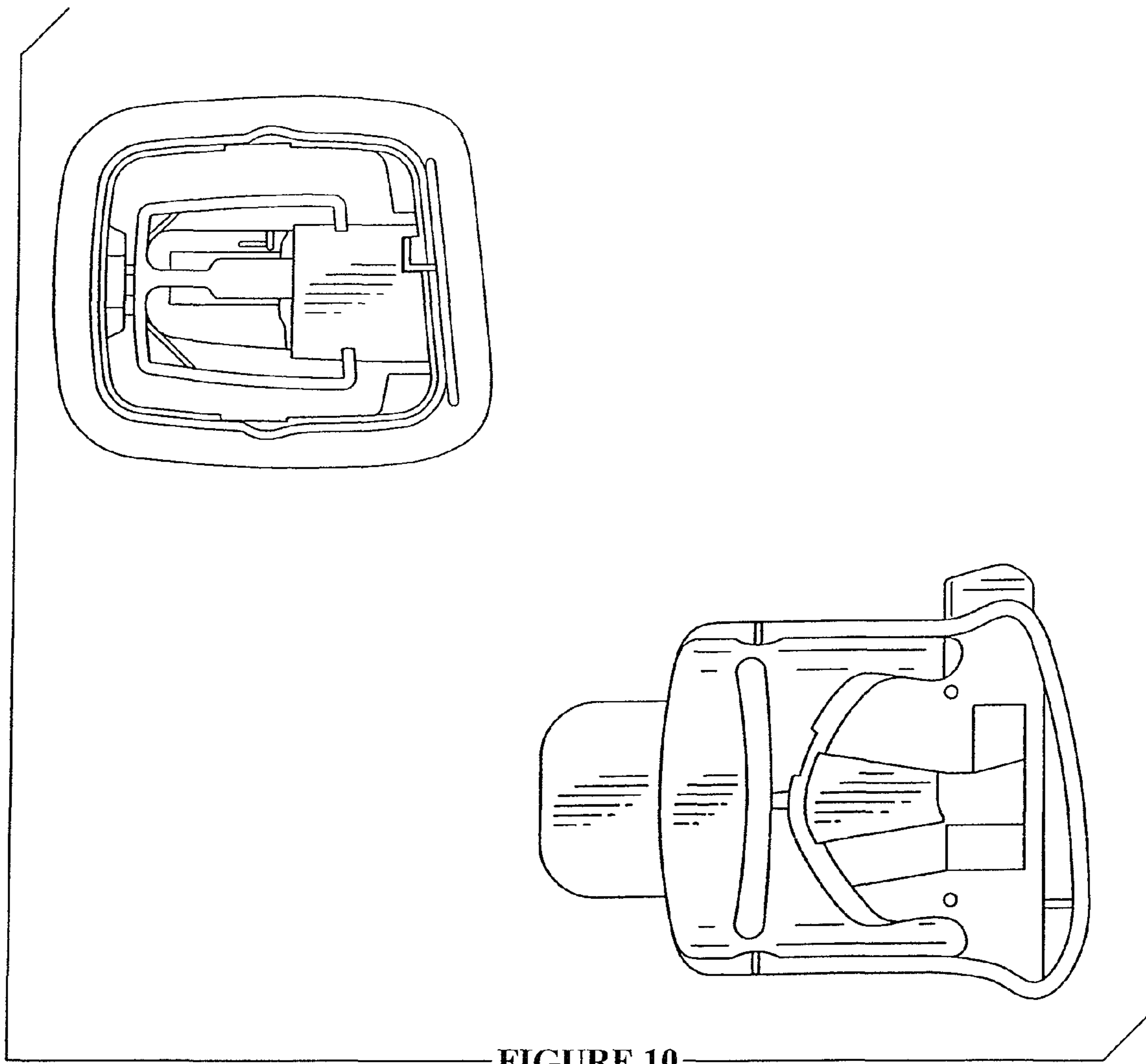

FIGURE 10

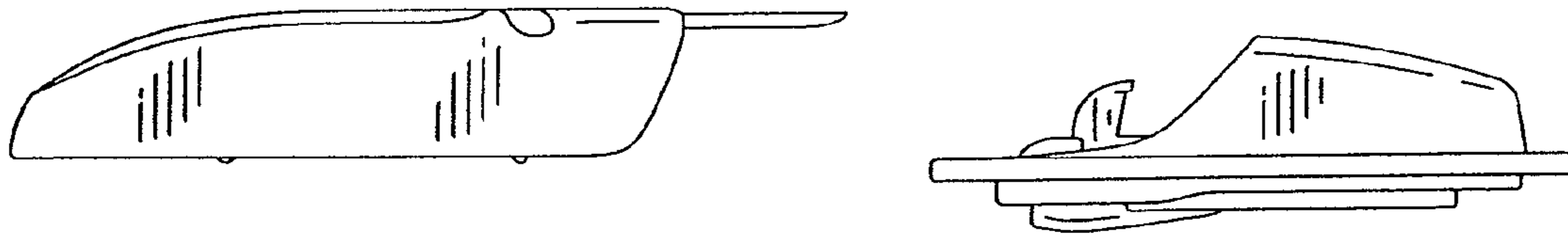

FIGURE 11

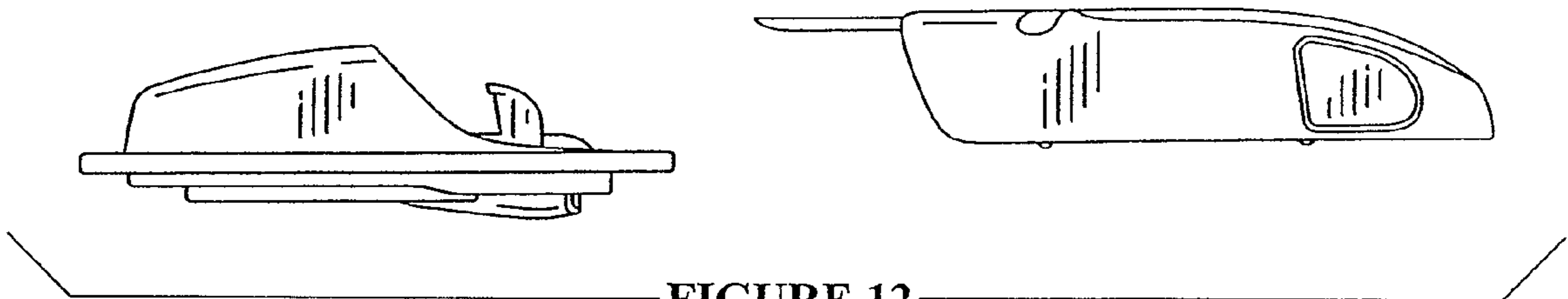

FIGURE 12

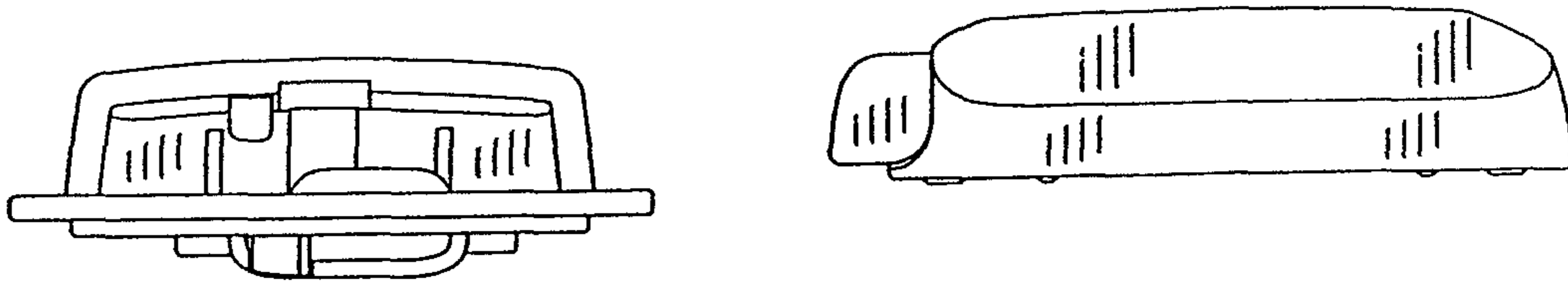

FIGURE 13

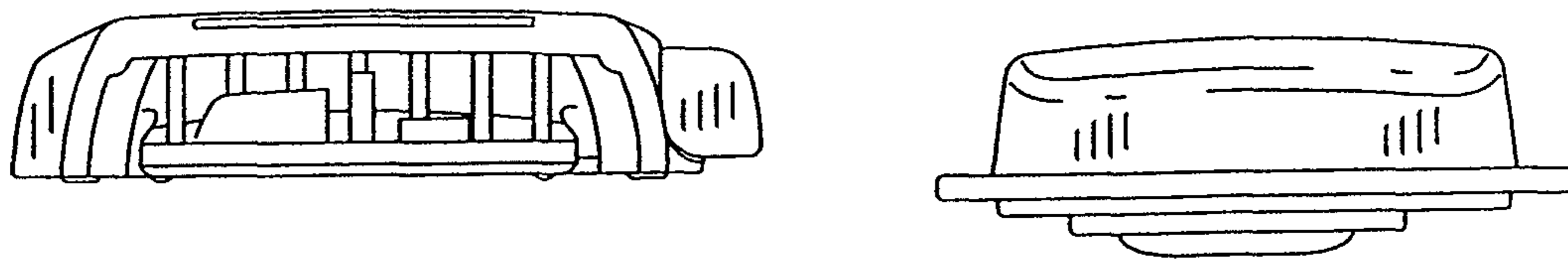

FIGURE 14