



US00D683628S

(12) **United States Design Patent**
Claassen

(10) **Patent No.:** **US D683,628 S**
(45) **Date of Patent:** **** Jun. 4, 2013**

- (54) **BOTTLE**
- (71) Applicant: **Reckitt Beckiser LLC.**, Parsippany, NJ (US)
- (72) Inventor: **Arnoldus Johannes Claassen**, Eindhoven (NL)
- (73) Assignee: **Reckitt Benckiser LLC**, Parsippany, NJ (US)
- (**) Term: **14 Years**
- (21) Appl. No.: **29/434,850**
- (22) Filed: **Oct. 17, 2012**

Related U.S. Application Data

- (62) Division of application No. 29/382,149, filed on Dec. 29, 2010.

(30) **Foreign Application Priority Data**

Jul. 5, 2010 (EM) 001727686-0001
 Jul. 5, 2010 (EM) 001727686-0002
 Jul. 5, 2010 (EM) 001727686-0003

- (51) **LOC (9) Cl.** **09-01**
- (52) **U.S. Cl.**
USPC **D9/542; D9/571; D9/574; D9/453**
- (58) **Field of Classification Search**
USPC D9/516, 529-530, 537, 539-542, D9/558, 571-575, 682-694, 435, 453-454; 215/379, 381-382, 384; 220/660, 662, 669
See application file for complete search history.

(56) **References Cited**

U.S. PATENT DOCUMENTS

D91,080 S * 11/1933 Nitardy D9/542
 D92,436 S * 6/1934 Stevens D9/543

D112,704 S * 12/1938 Nitardy D9/542
 D324,999 S * 3/1992 Zogg et al. D9/542
 D352,460 S * 11/1994 Sherman et al. D9/542
 5,370,266 A * 12/1994 Woodruff 222/212 X
 D363,667 S * 10/1995 Baratta-Dragono et al. .. D9/542
 D364,092 S * 11/1995 Feen D9/542
 D506,140 S * 6/2005 Maus D9/542
 D511,970 S * 11/2005 Cleary D9/563 X
 D541,666 S * 5/2007 Verde D9/668
 D580,264 S * 11/2008 Szasz D9/453 X
 D591,608 S * 5/2009 Marotti et al. D9/571
 D607,339 S * 1/2010 Sanborn et al. D9/574 X
 D617,639 S * 6/2010 Casey et al. D9/454 X
 D619,002 S * 7/2010 Casey et al. D9/454 X
 D624,429 S * 9/2010 Gedanke D9/574 X
 D646,797 S * 10/2011 Oonuma et al. D24/232
 D649,060 S * 11/2011 Wheaton et al. D9/571 X
 D650,688 S * 12/2011 Simmons D9/542
 D655,611 S * 3/2012 Teitelbaum et al. D9/574 X
 D662,828 S * 7/2012 Jackson et al. D9/575 X

* cited by examiner

Primary Examiner — Carol P Rademaker

(74) *Attorney, Agent, or Firm* — Norris McLaughlin & Marcus PA

(57) **CLAIM**

The ornamental design for a bottle, as shown and described.

DESCRIPTION

FIG. 1 is a front, top, and right side perspective view of my bottle;
 FIG. 2 is a front elevational view thereof;
 FIG. 3 is a rear elevational view thereof;
 FIG. 4 is a right side elevational view thereof;
 FIG. 5 is a left side elevational view thereof;
 FIG. 6 is a top plan view thereof; and,
 FIG. 7 is a bottom plan view thereof.
 The broken lines shown in the drawings are included for the purpose of illustrating environmental structure and form no part of the claimed design.

1 Claim, 6 Drawing Sheets

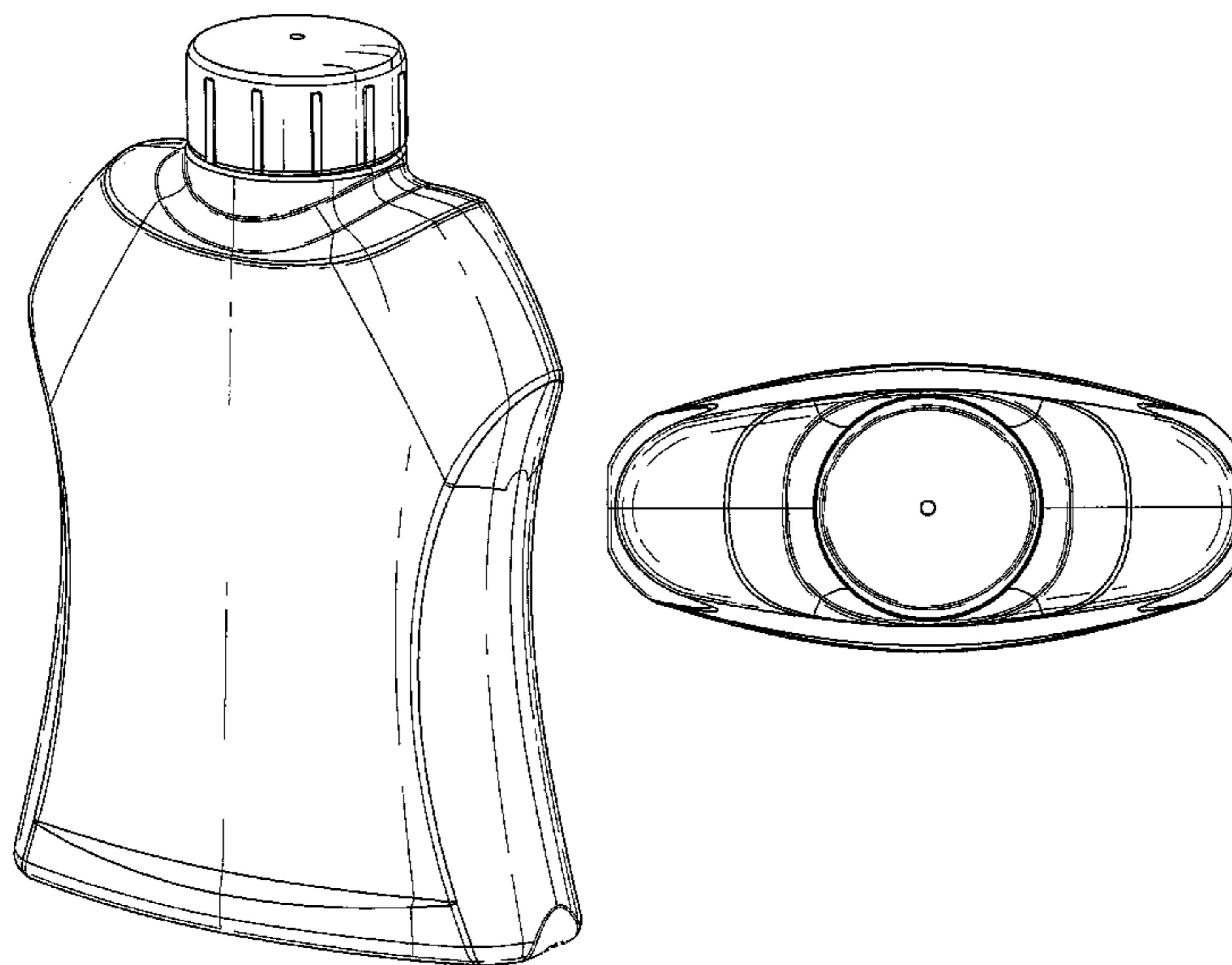

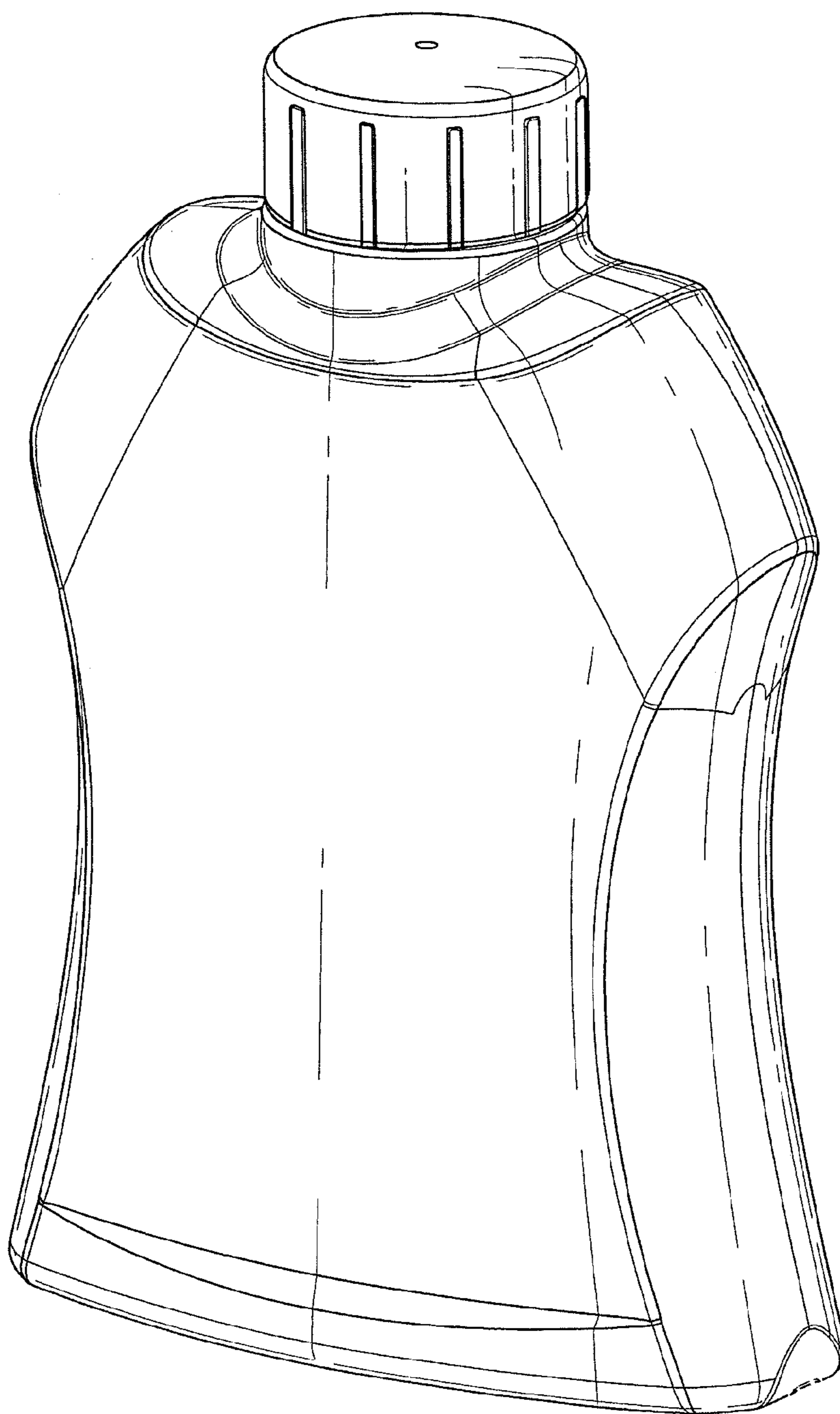

Fig. 1

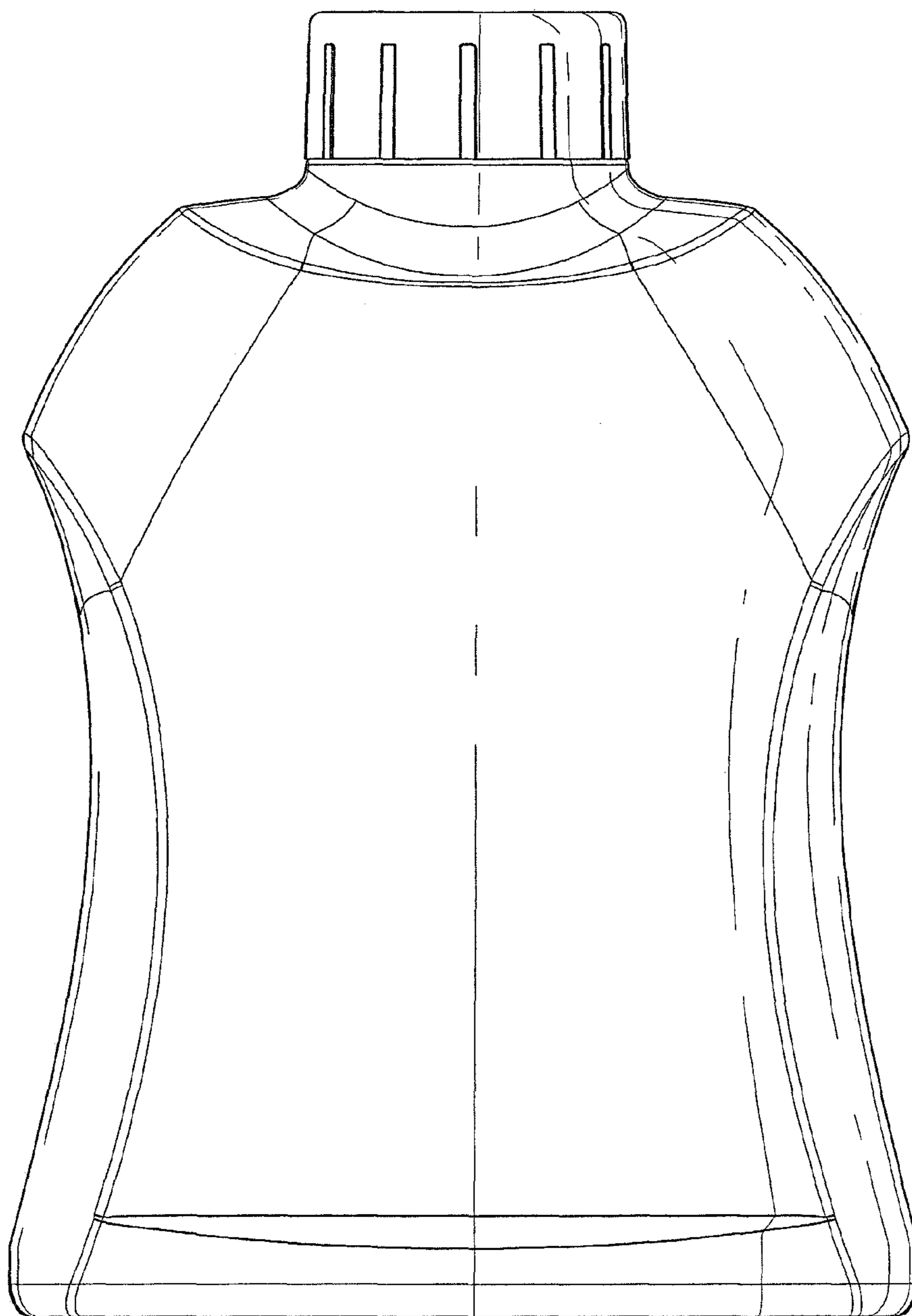

Fig. 2

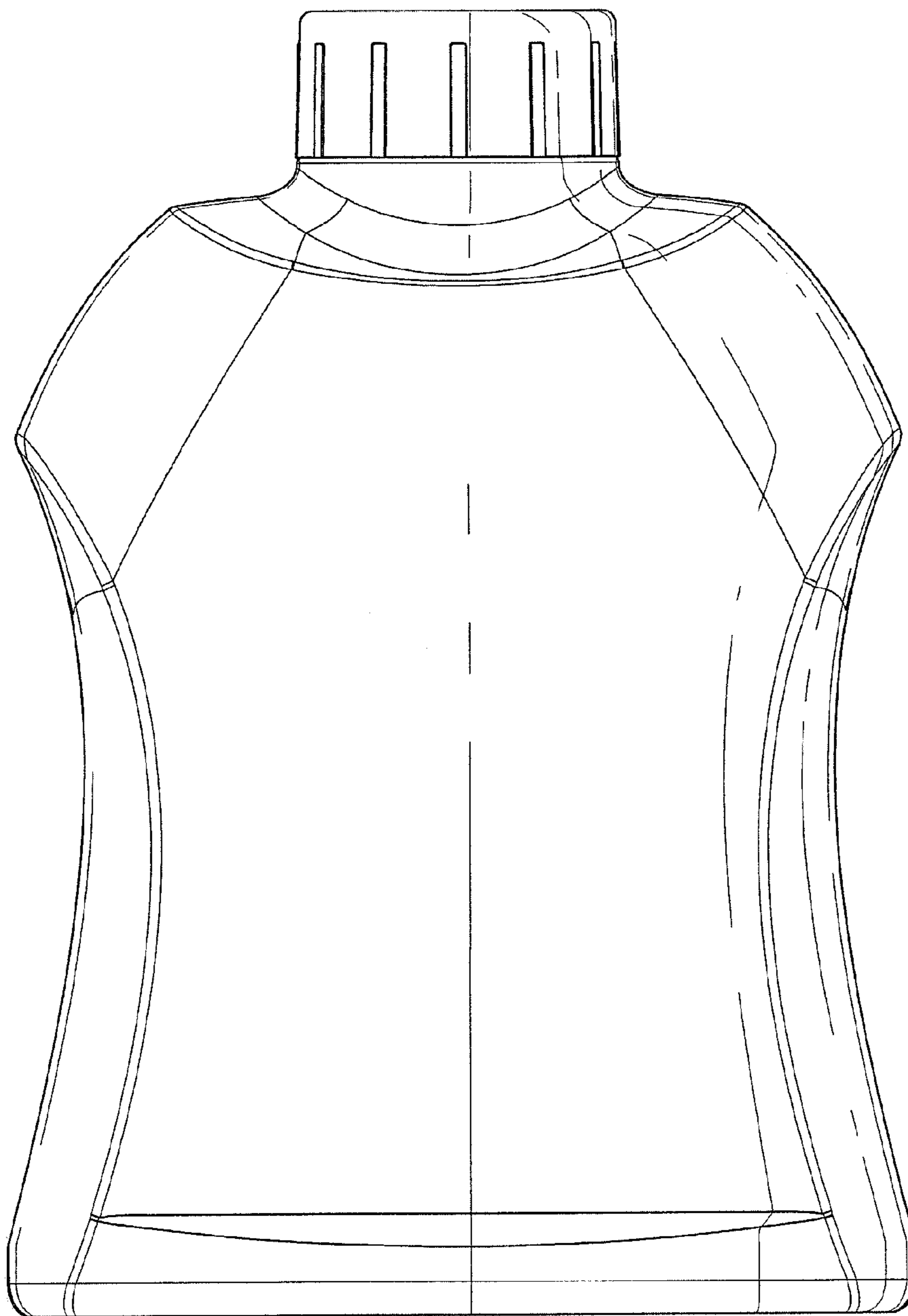

Fig. 3

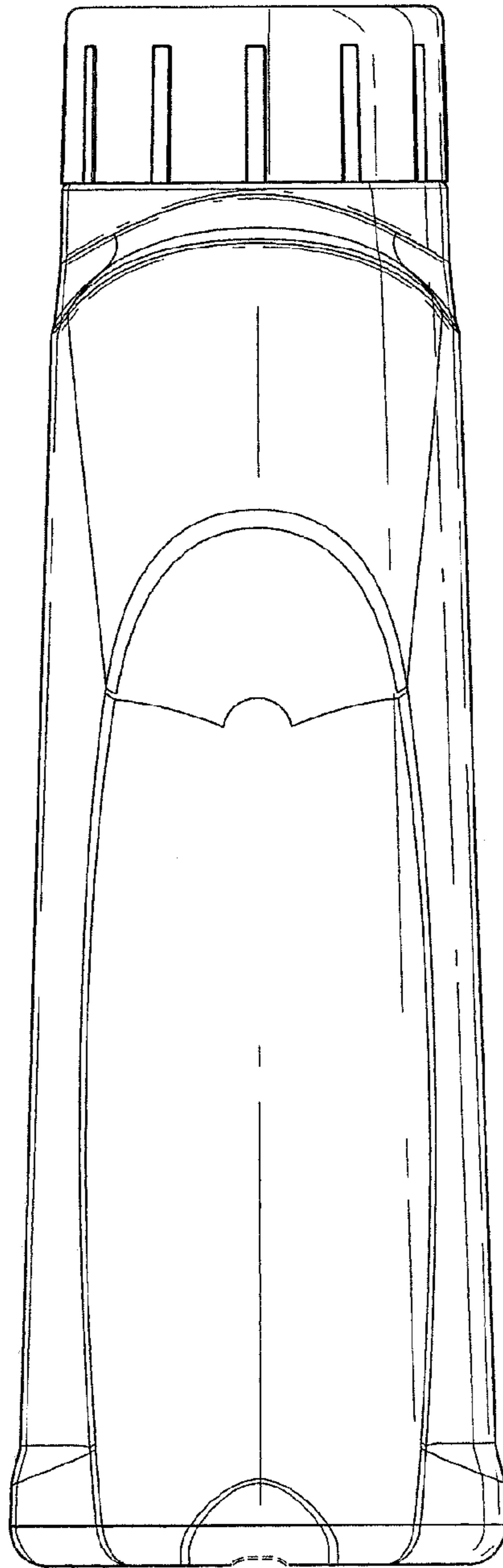

Fig. 4

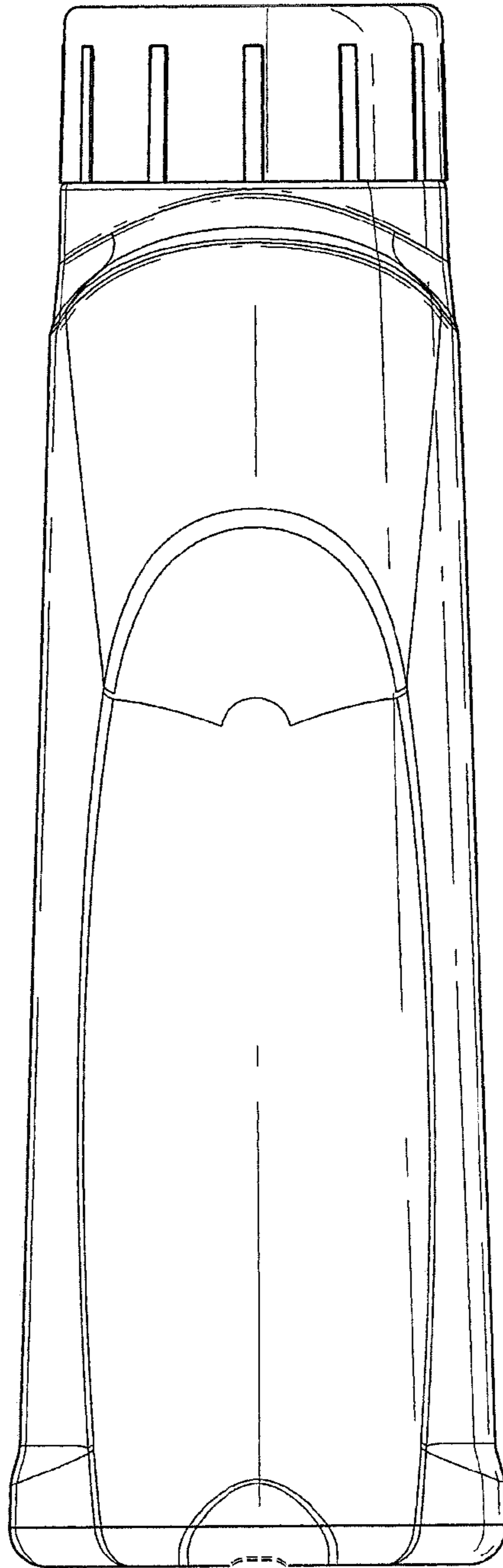

Fig. 5

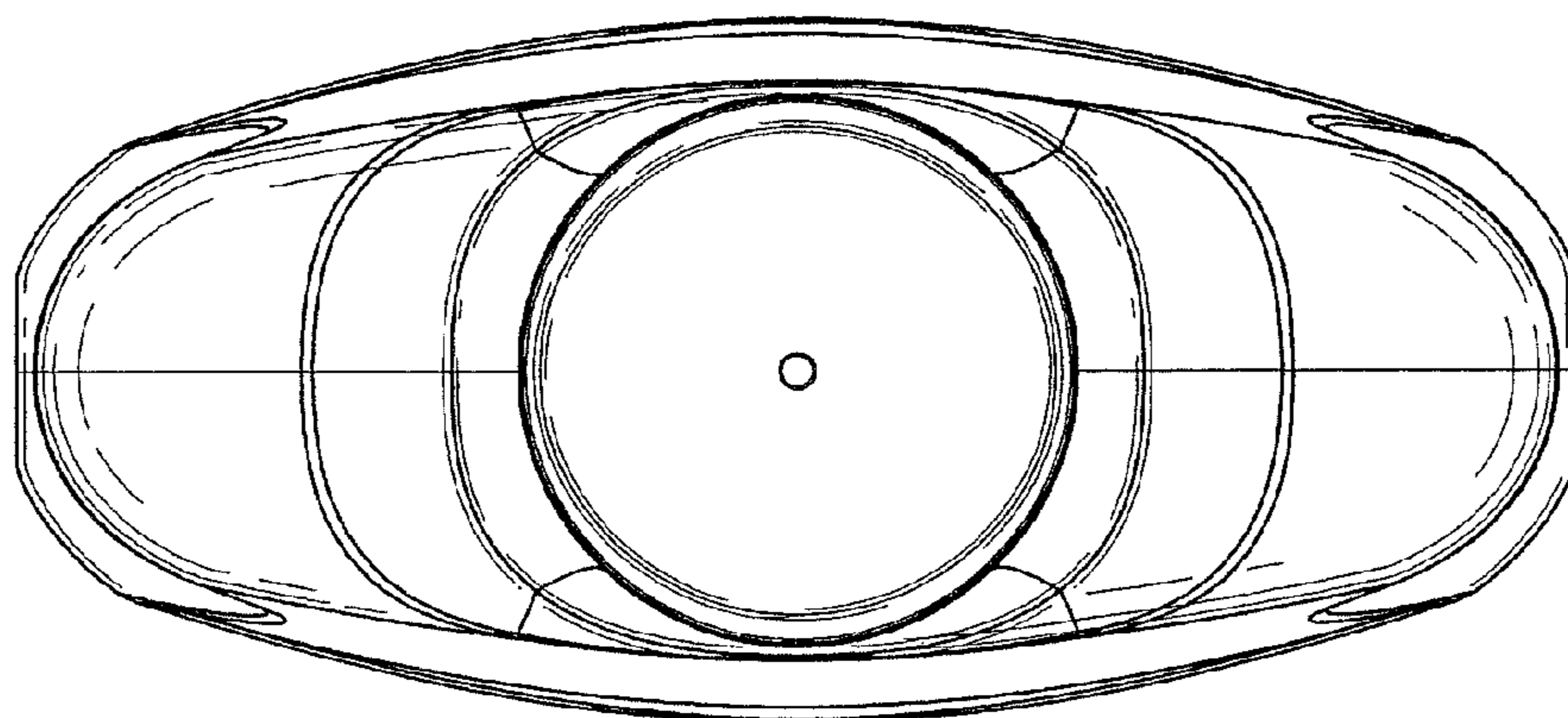

Fig. 6

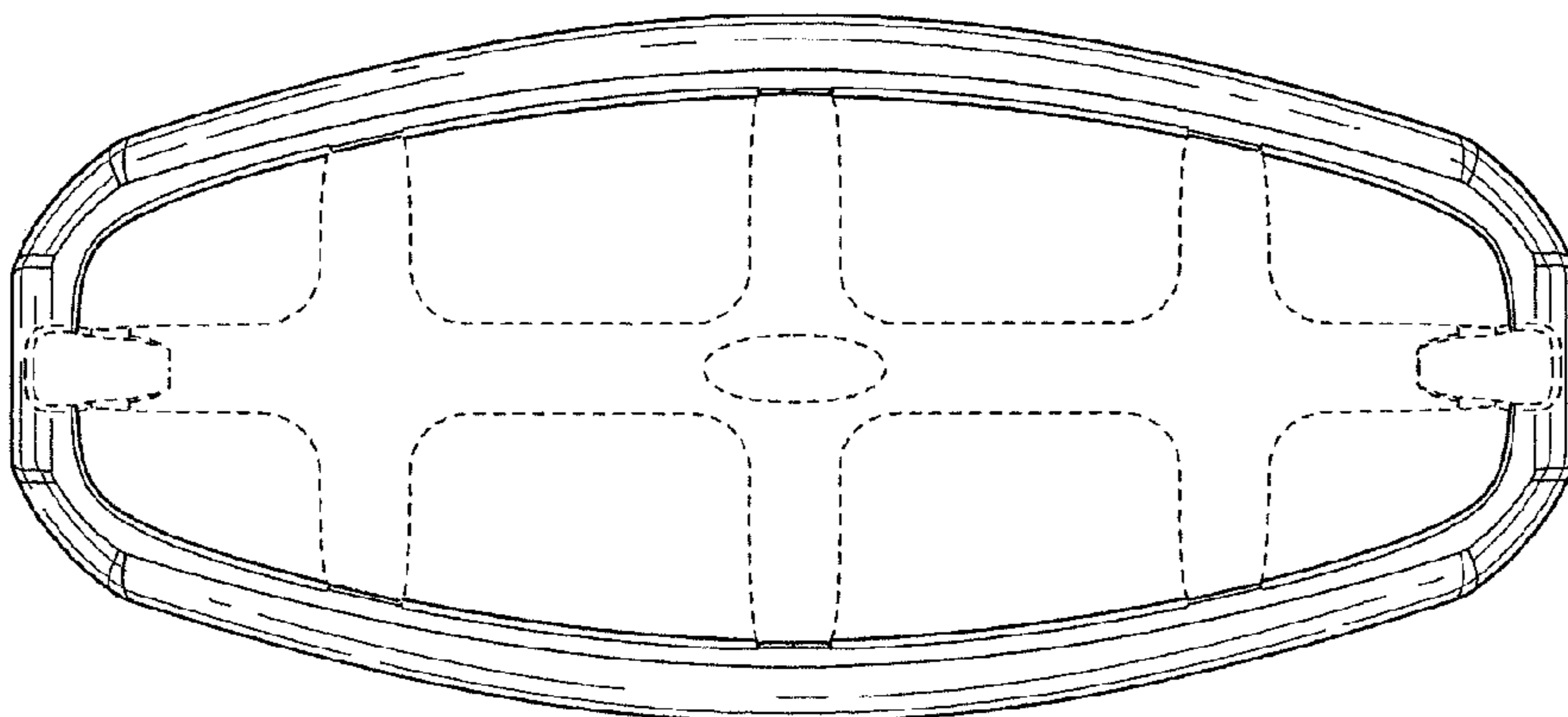

Fig. 7