



US00D683610S

(12) **United States Design Patent**
Eriksson

(10) **Patent No.:** **US D683,610 S**

(45) **Date of Patent:** **** Jun. 4, 2013**

(54) **LOCKABLE STRAP HOUSING**

7,497,102 B2 * 3/2009 Yu 70/58
D650,654 S * 12/2011 Fong D8/332
D658,036 S * 4/2012 Fong D8/339

(75) Inventor: **Henrik Eriksson**, Jonkoping (SE)

* cited by examiner

(73) Assignee: **Thule Sweden AB** (SE)

Primary Examiner — Prabhakar Deshmukh

(**) Term: **14 Years**

(74) *Attorney, Agent, or Firm* — Novak Druce Connolly Bove + Quigg LLP

(21) Appl. No.: **29/406,472**

(57) **CLAIM**

(22) Filed: **Nov. 15, 2011**

I claim the ornamental design for a lockable strap housing, as shown and described.

(51) **LOC (9) Cl.** **08-07**

(52) **U.S. Cl.**
USPC **D8/330**

DESCRIPTION

(58) **Field of Classification Search**
USPC D8/330-348, 349, 382, 394, 383; 70/14,
70/57, 57.1, 52, 128, 129, 333 R, 334, 416,
70/429, 430, 158-173, 18, 25, 26; 206/1.5
See application file for complete search history.

FIG. 1 is a perspective view of a lockable strap housing;
FIG. 2 is a right side elevational view thereof;
FIG. 3 is a left side elevational view thereof;
FIG. 4 is a rear elevational view thereof;
FIG. 5 is a front elevational view thereof;
FIG. 6 is a bottom plan view thereof;
FIG. 7 is a top plan view thereof;
FIG. 8 is a closed configuration thereof with a securement
strap in place; and,
FIG. 9 is an open configuration thereof.
The broken lines in FIG. 6 illustrate unclaimed portions of the
lockable strap housing. The broken lines in FIGS. 8 and 9
illustrate environment. The broken lines form no part of the
claimed design.

(56) **References Cited**

U.S. PATENT DOCUMENTS

4,382,318	A *	5/1983	Takimoto	24/188
D450,561	S *	11/2001	Moore et al.	D8/349
6,687,964	B2 *	2/2004	Vanderpool	24/614
D496,247	S *	9/2004	Roach	D8/339
D524,633	S *	7/2006	Robert et al.	D8/339
7,121,122	B2 *	10/2006	Levi	70/18
D532,541	S *	11/2006	Krieger et al.	D26/45
7,424,813	B2 *	9/2008	Wu	70/58

1 Claim, 9 Drawing Sheets

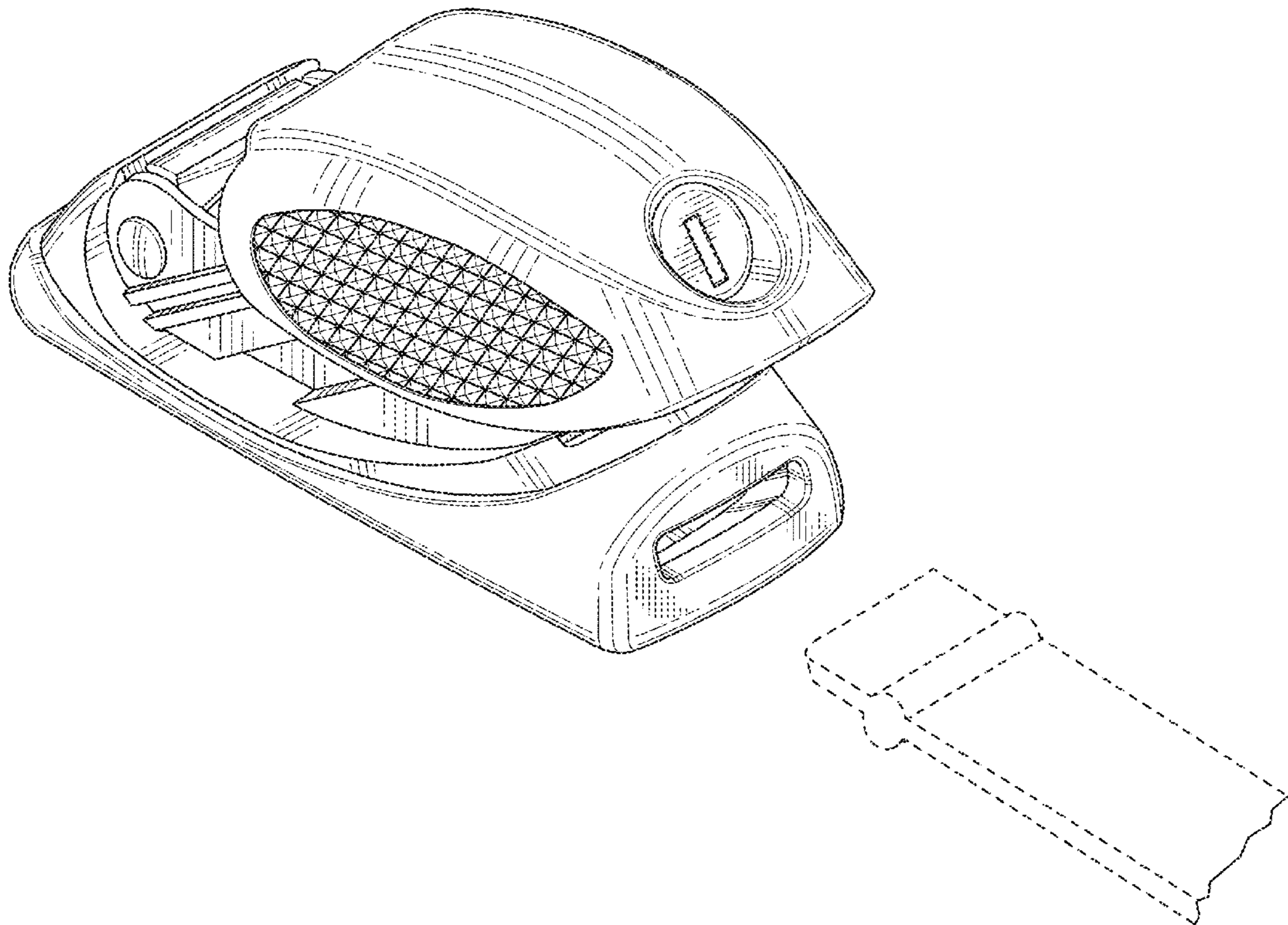

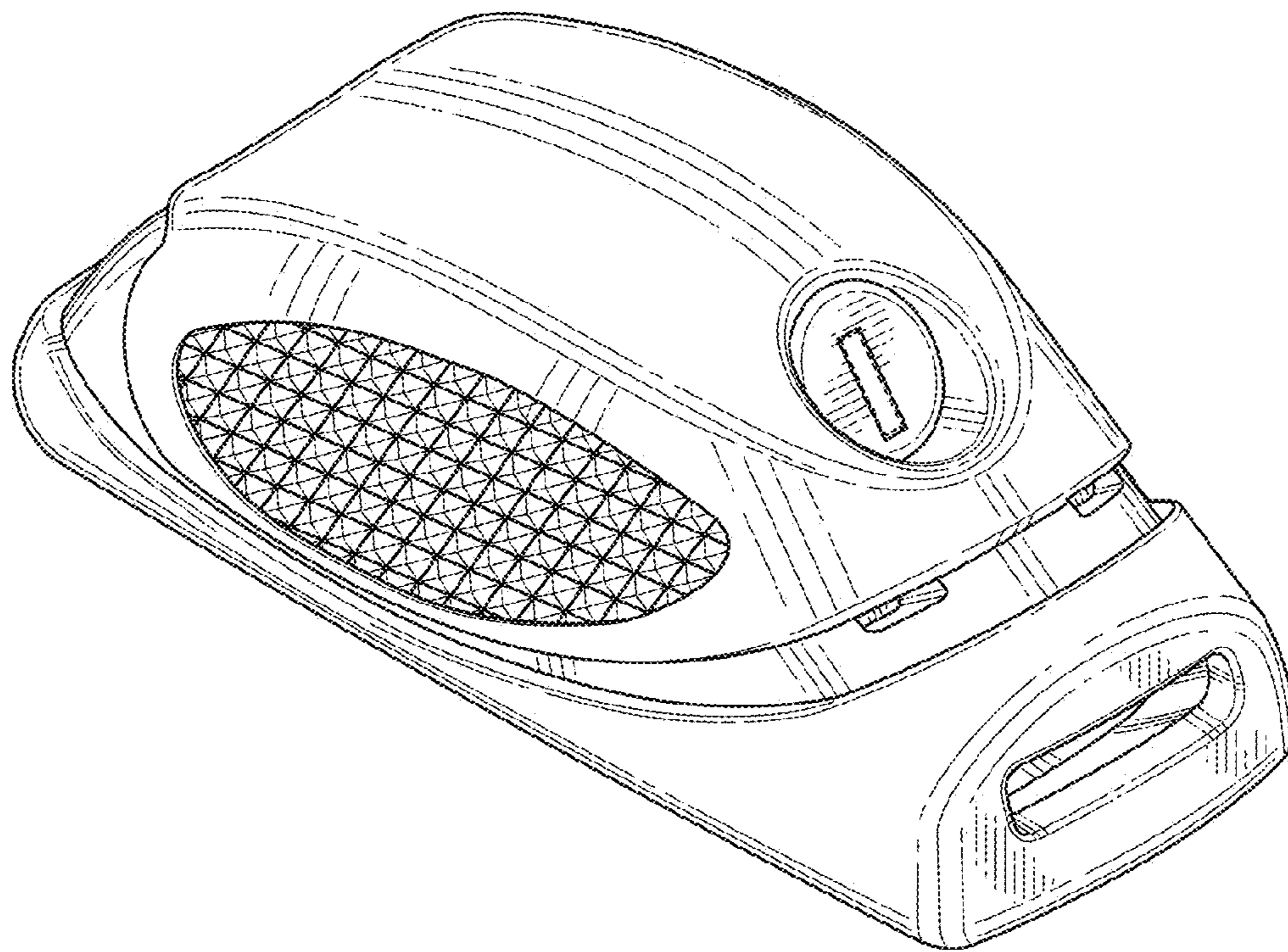

FIG. 1

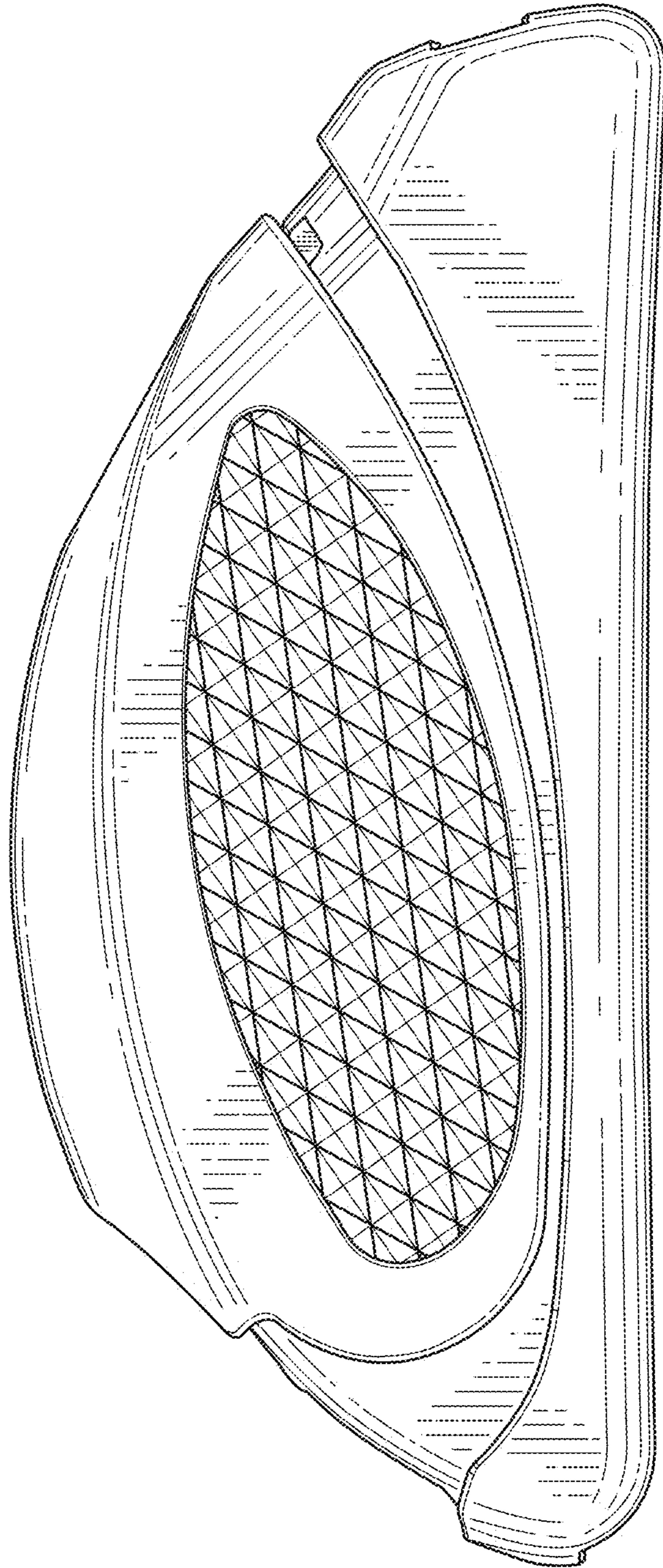

FIG. 2

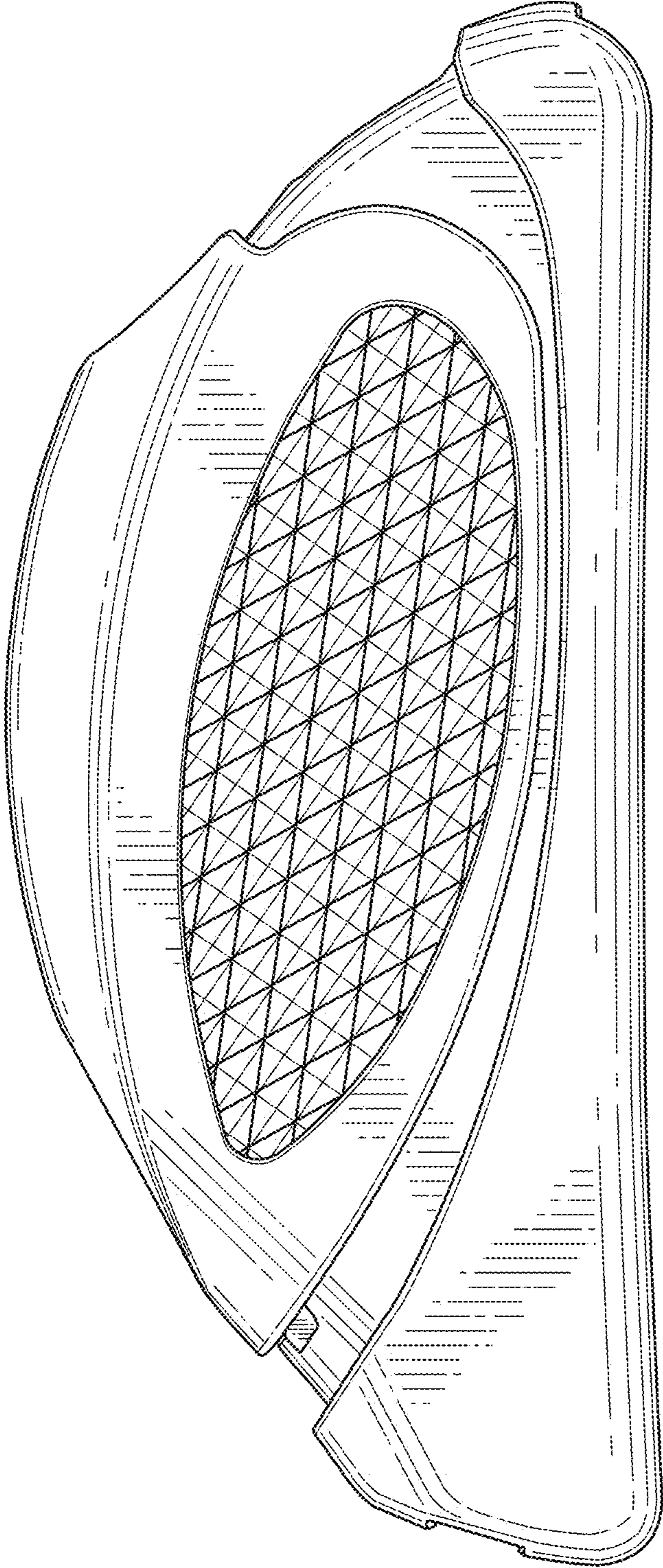

FIG. 3

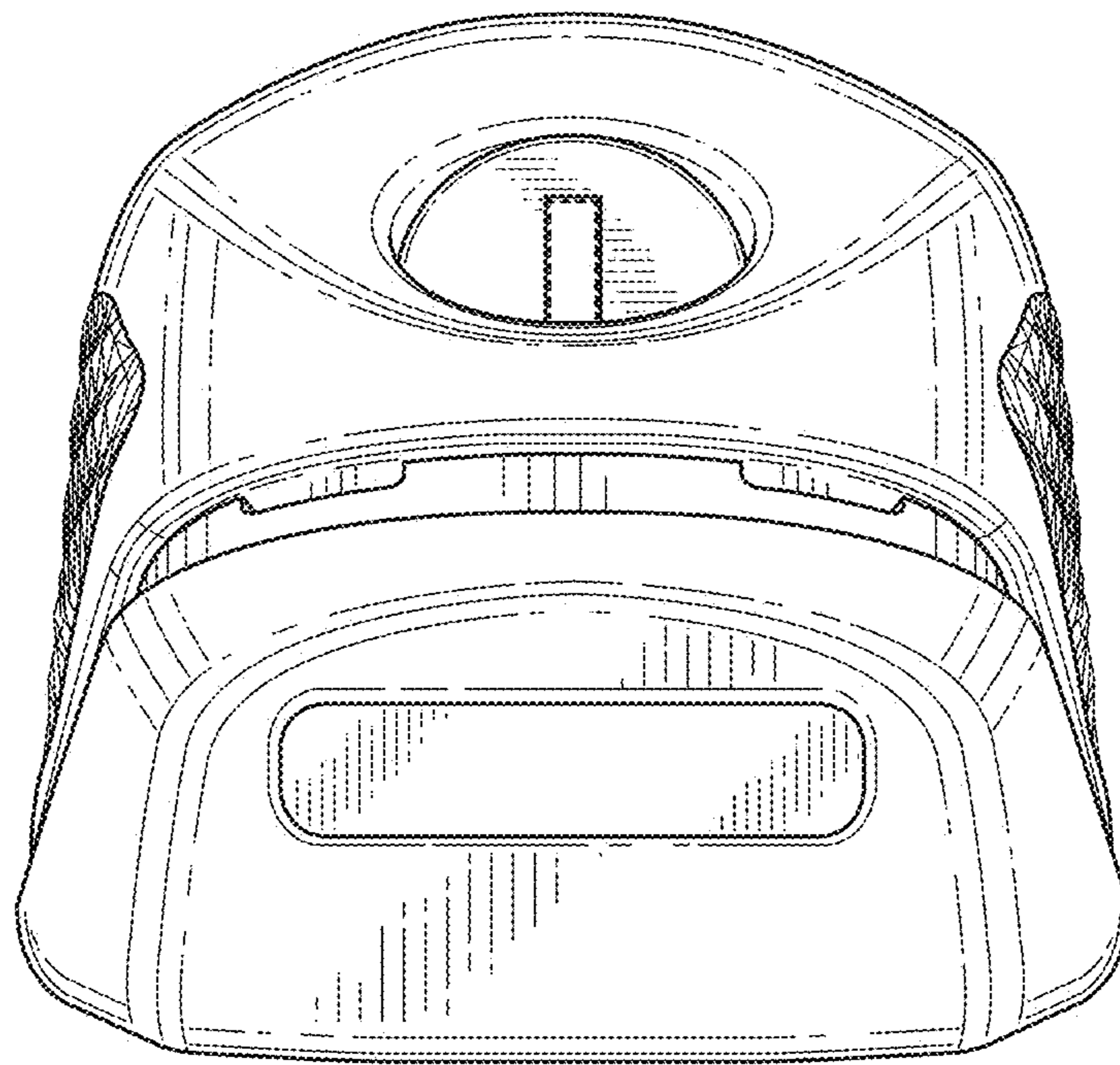

FIG. 4

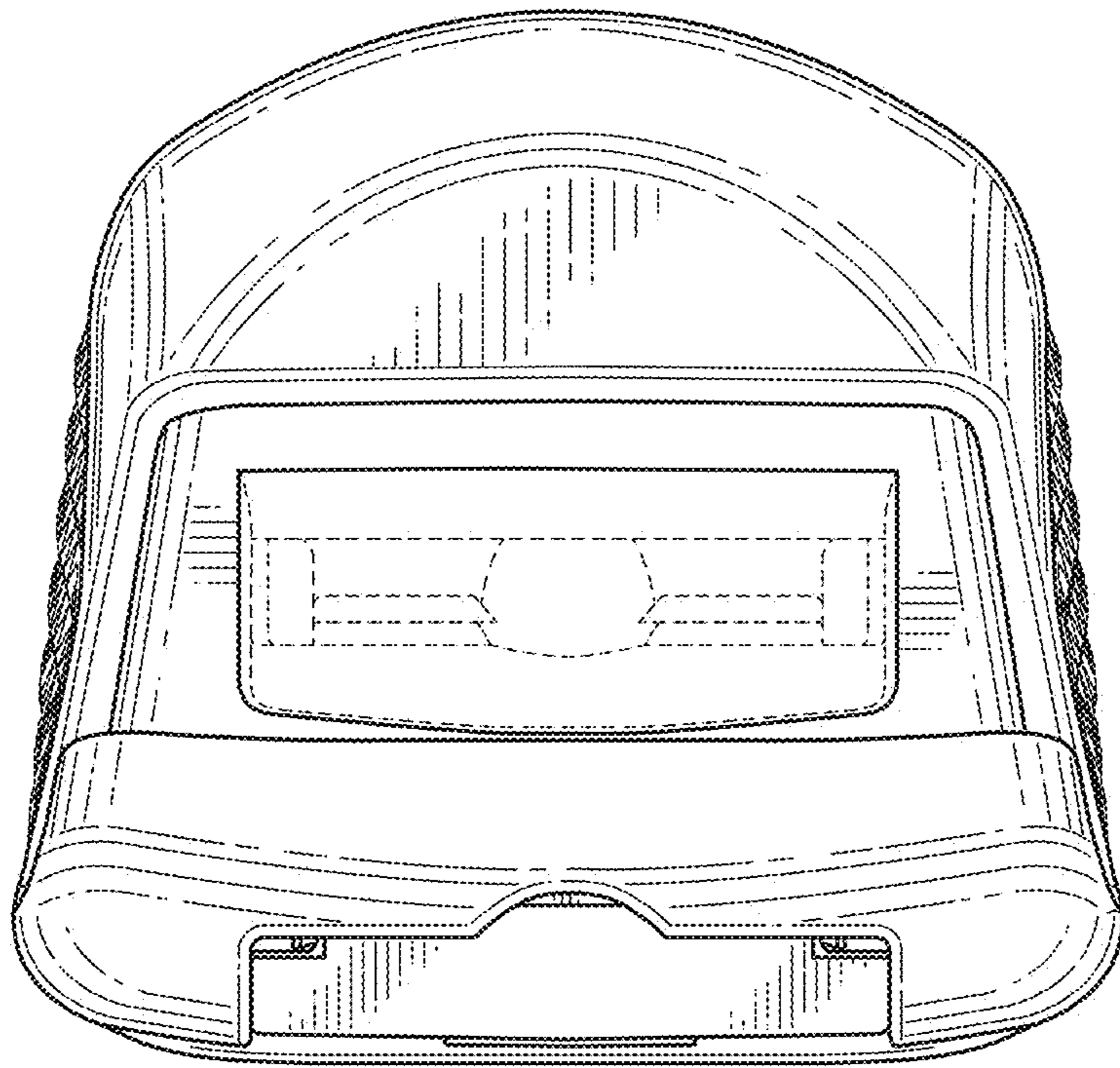

FIG. 5

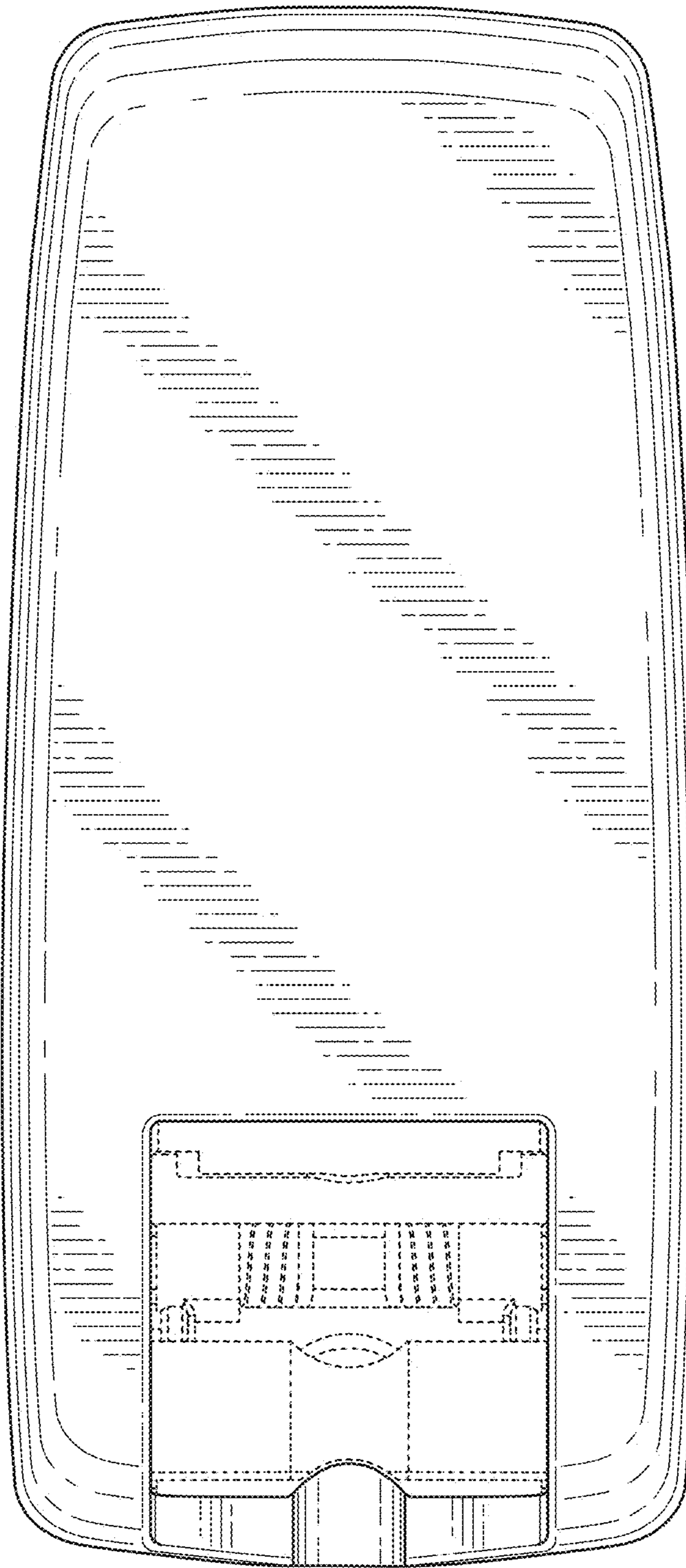

FIG. 6

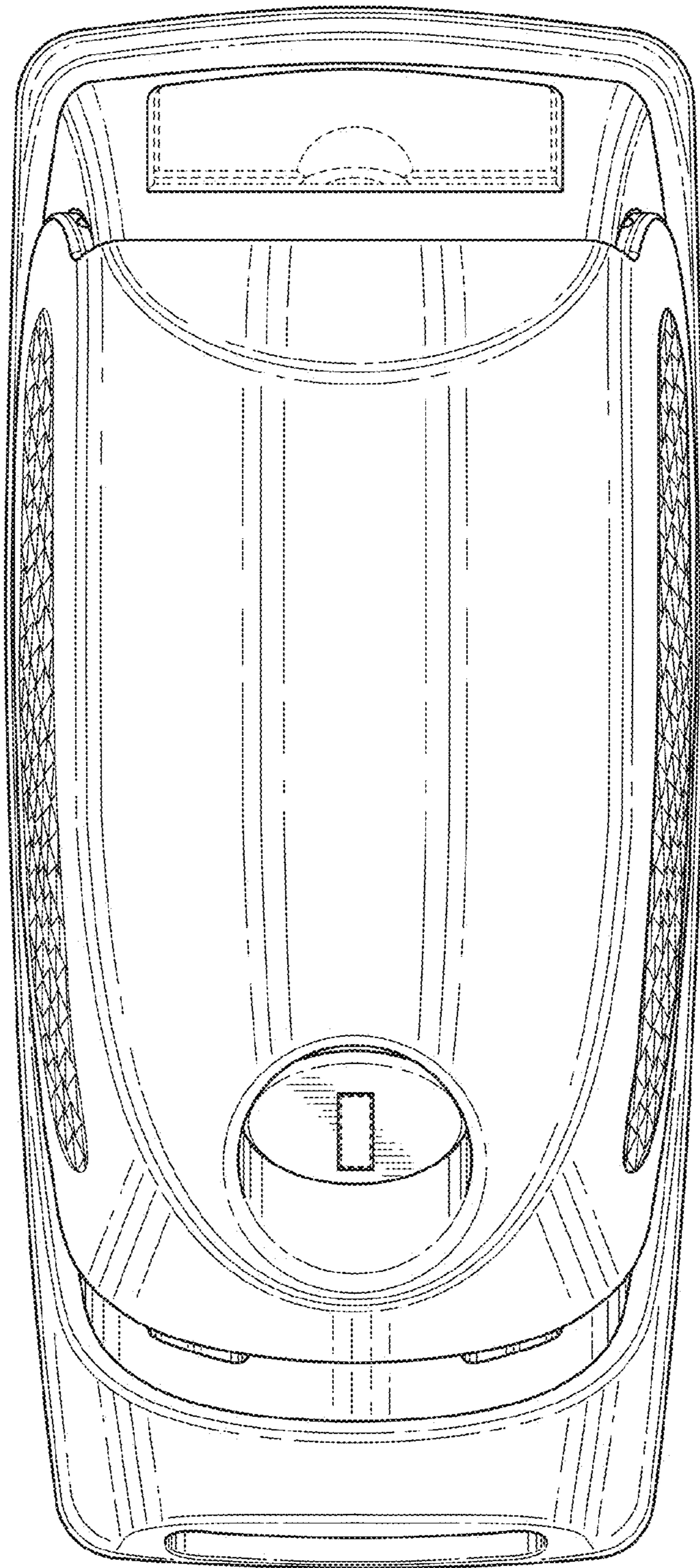

FIG.7

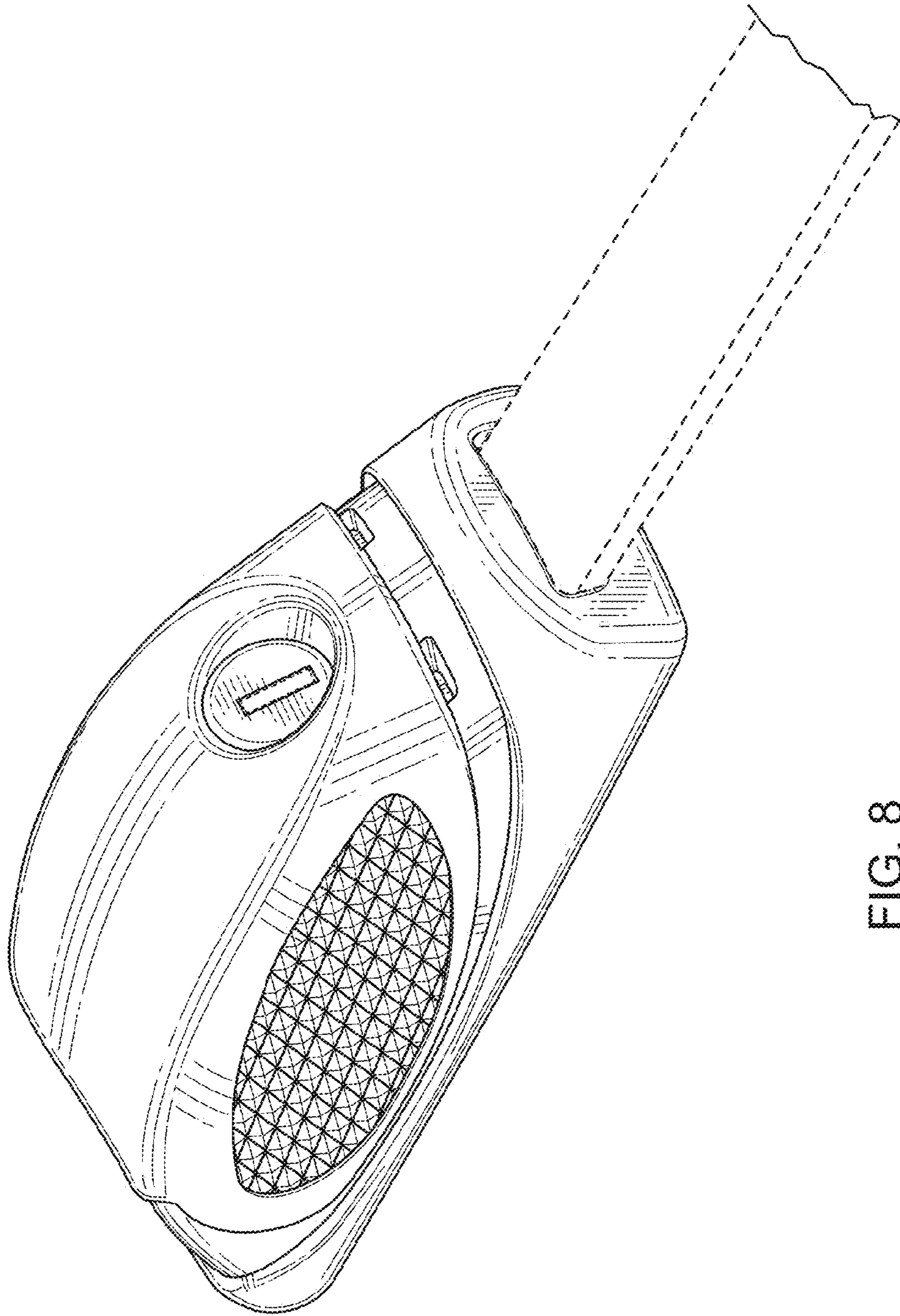

FIG. 8

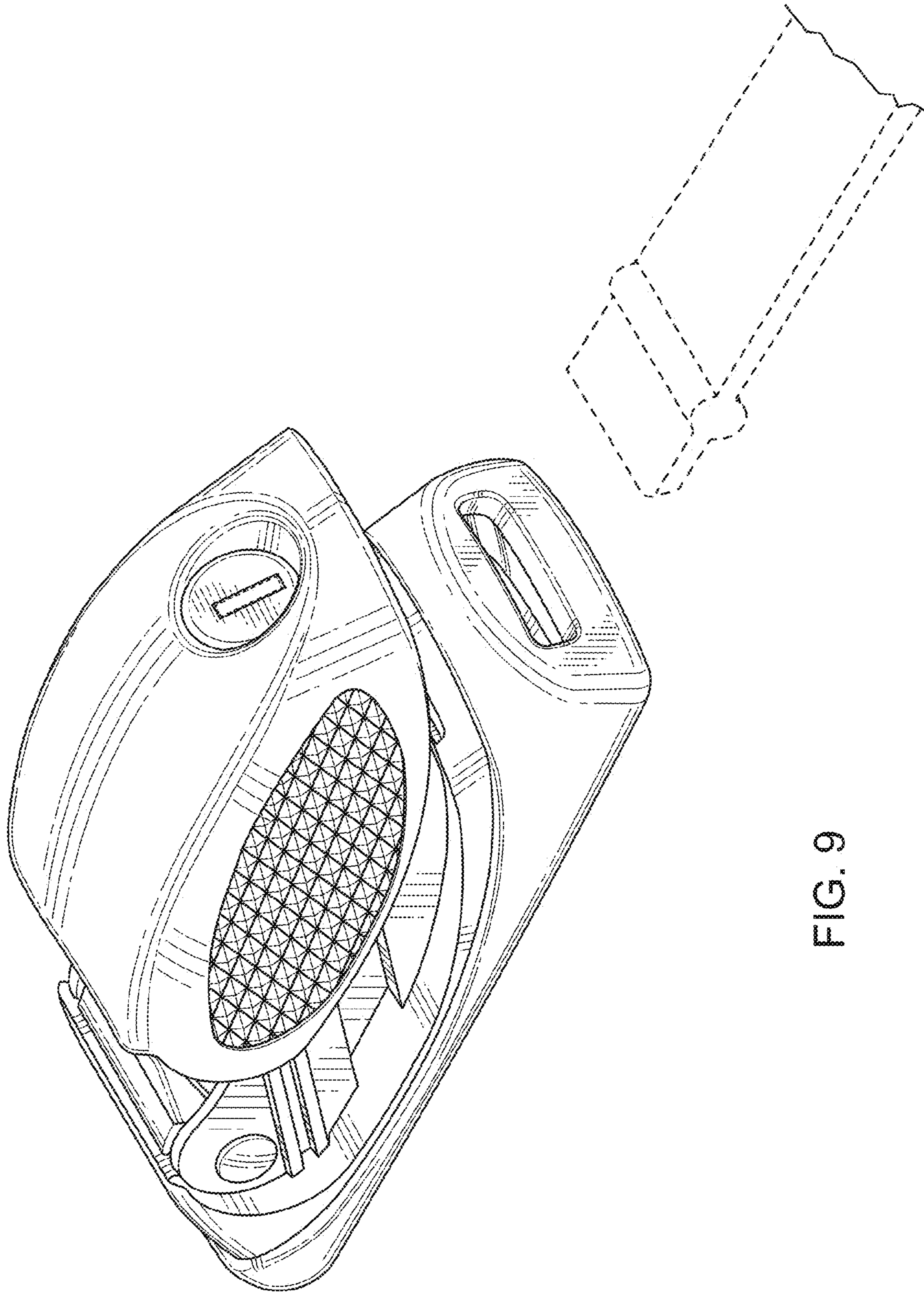

FIG. 9