



US00D683594S

(12) **United States Design Patent**
Munoz

(10) **Patent No.:** **US D683,594 S**
(45) **Date of Patent:** **** Jun. 4, 2013**

(54) **BOWL SEPARATOR**

(76) Inventor: **Bert Munoz**, San Dimas, CA (US)

(**) Term: **14 Years**

(21) Appl. No.: **29/378,235**

(22) Filed: **Nov. 1, 2010**

(51) **LOC (9) Cl.** **07-01**

(52) **U.S. Cl.**
USPC **D7/555; D7/396.1**

(58) **Field of Classification Search**
USPC D7/555, 387, 392.1, 396.1; 206/561,
206/521.15; D9/434, 456; 366/130; D30/130;
220/694, 575

See application file for complete search history.

(56) **References Cited**

U.S. PATENT DOCUMENTS

766,427	A *	8/1904	Crowel	220/575
D38,779	S *	9/1907	Wilhelm et al.	D7/555
D43,656	S *	2/1913	Van de Verg	D7/555
1,379,519	A *	5/1921	Bjornsen	220/575
D122,576	S *	9/1940	Steinhilber	D7/557
D176,824	S *	1/1956	Sacla et al.	D7/555
D259,774	S *	7/1981	Criscitiello, Jr.	D11/143
4,351,444	A *	9/1982	Majewski	220/575
D298,000	S *	10/1988	Ritman	D7/584
5,172,826	A *	12/1992	Celaya	220/574
5,341,953	A *	8/1994	Forester	220/575
D386,358	S *	11/1997	Pfeilsticker	D7/555

D390,419	S *	2/1998	Perlmutter et al.	D7/555
D444,034	S *	6/2001	Miller et al.	D7/546
D473,758	S *	4/2003	Wilson	D7/587
D515,866	S *	2/2006	Wiedmeyer et al.	D7/396.1
D546,630	S *	7/2007	Asner	D7/587
D564,844	S *	3/2008	Schreiber-Pethan et al.	..	D7/586
D587,406	S *	2/2009	Ruiz	D28/61
D587,971	S *	3/2009	Peabody et al.	D7/555
D600,861	S *	9/2009	Sin	D30/129
D613,124	S *	4/2010	Osborne	D7/555
D618,511	S *	6/2010	Lugacy	D7/546
D620,306	S *	7/2010	Tosdale et al.	D7/354

* cited by examiner

Primary Examiner — Cynthia Underwood
(74) *Attorney, Agent, or Firm* — Kafantaris Law Offices;
Theo Kafantaris

(57) **CLAIM**

The ornamental design for a bowl separator, as shown and described.

DESCRIPTION

FIG. 1 is an isometric view of a bowl separator showing my new design;
FIG. 2 is a top view thereof;
FIG. 3 is a side view thereof;
FIG. 4 is a front view thereof;
FIG. 5 is a side perspective view thereof; and,
FIG. 6 is a front perspective view thereof.

1 Claim, 6 Drawing Sheets

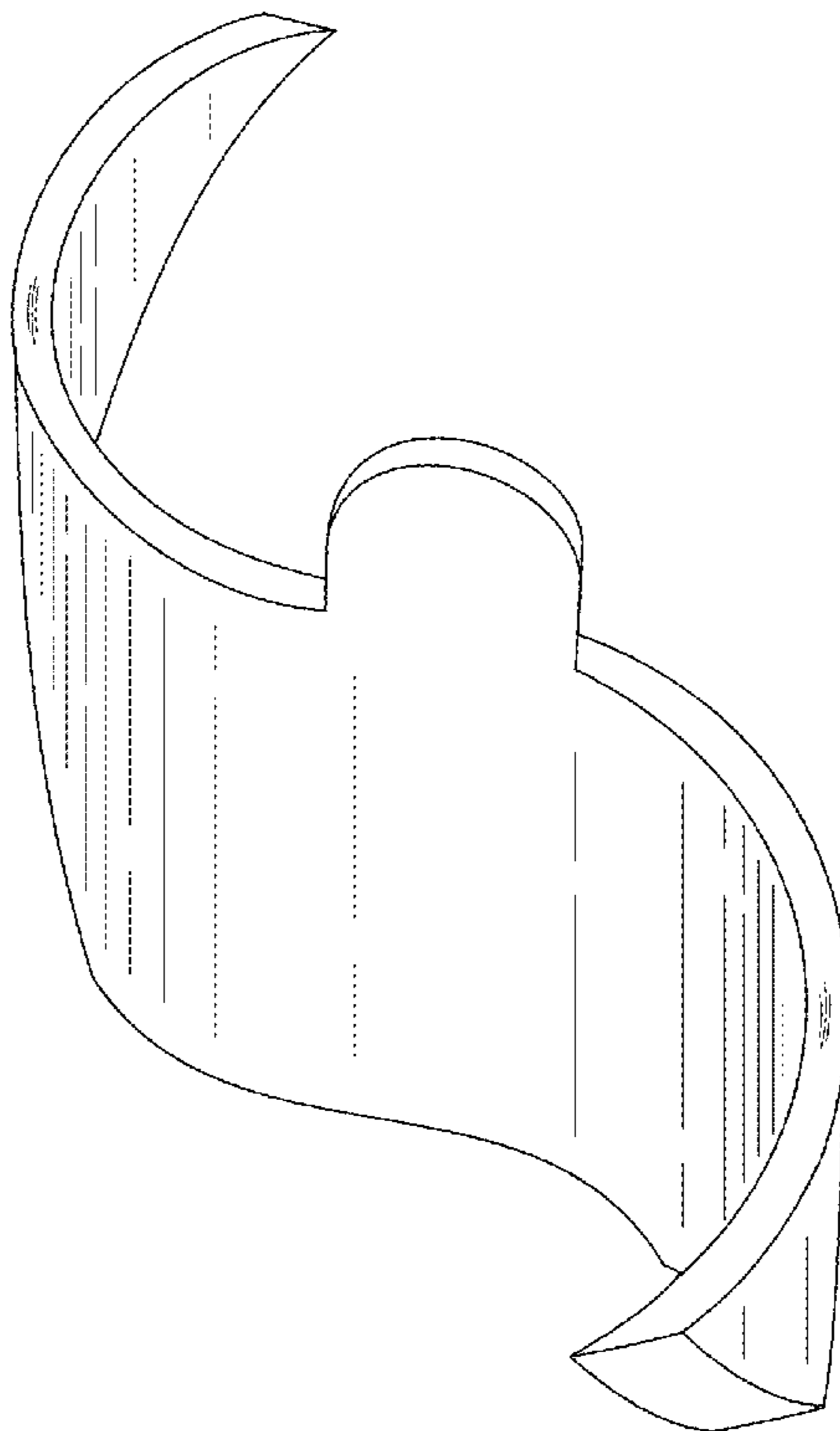

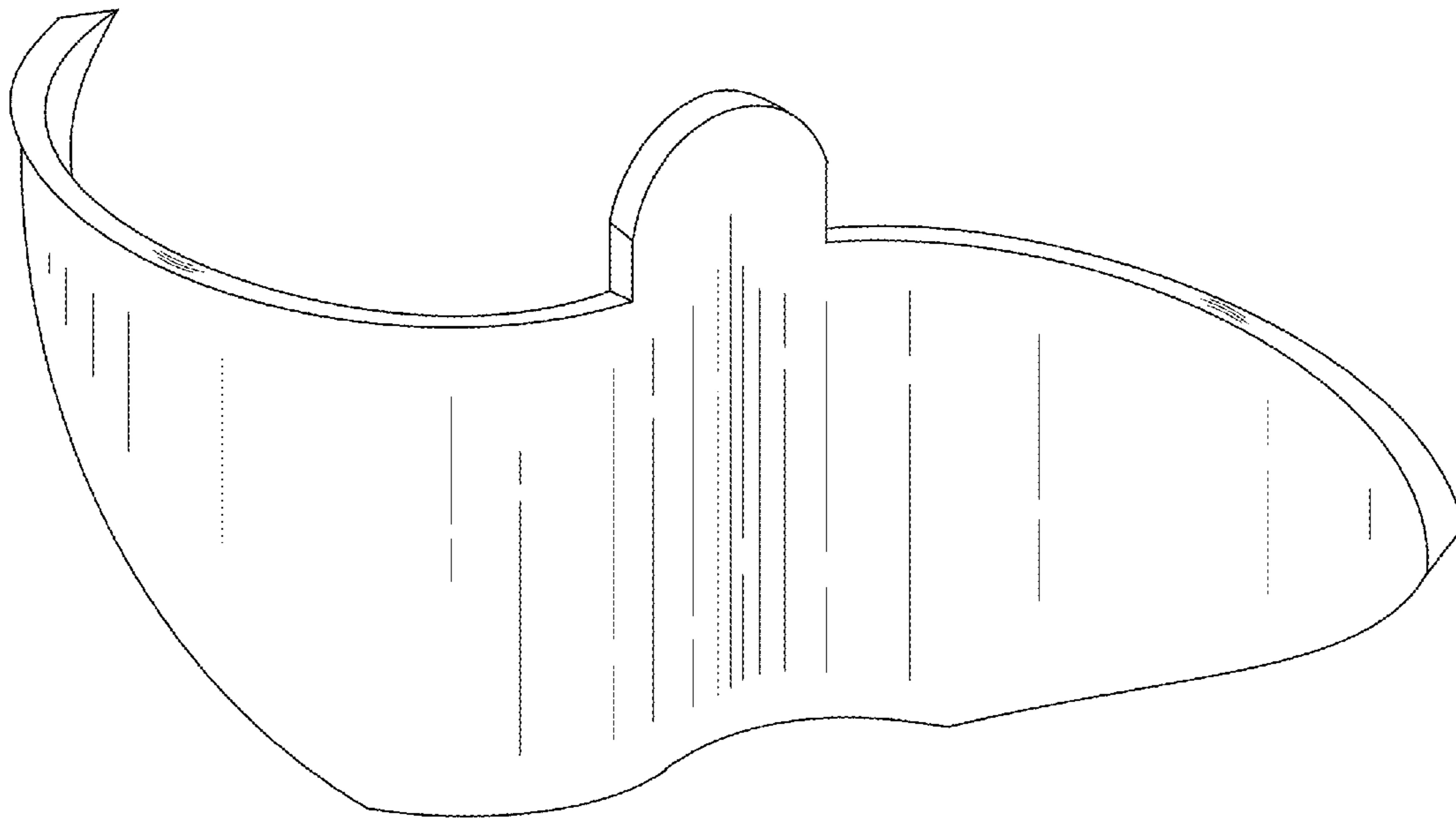

FIG. 1

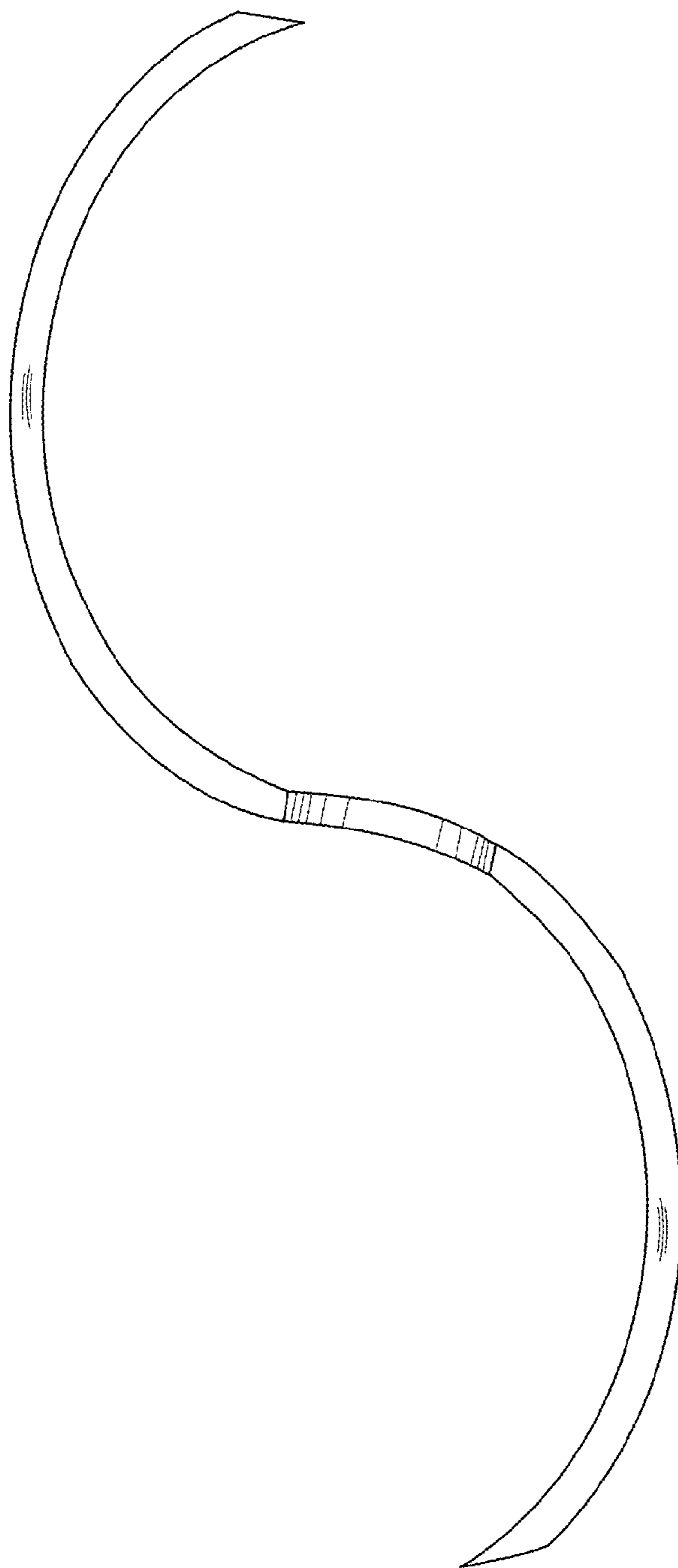

FIG. 2

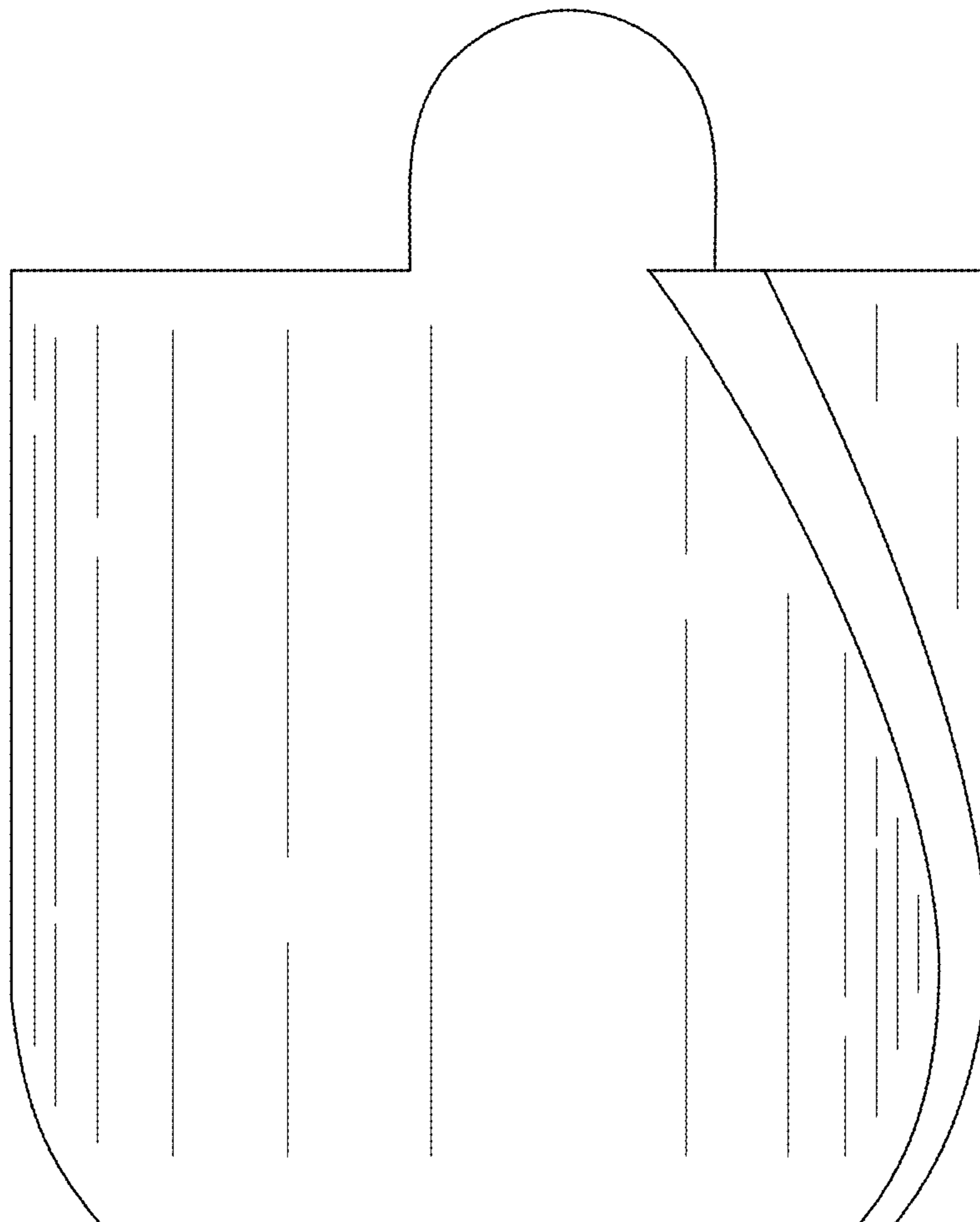

FIG. 3

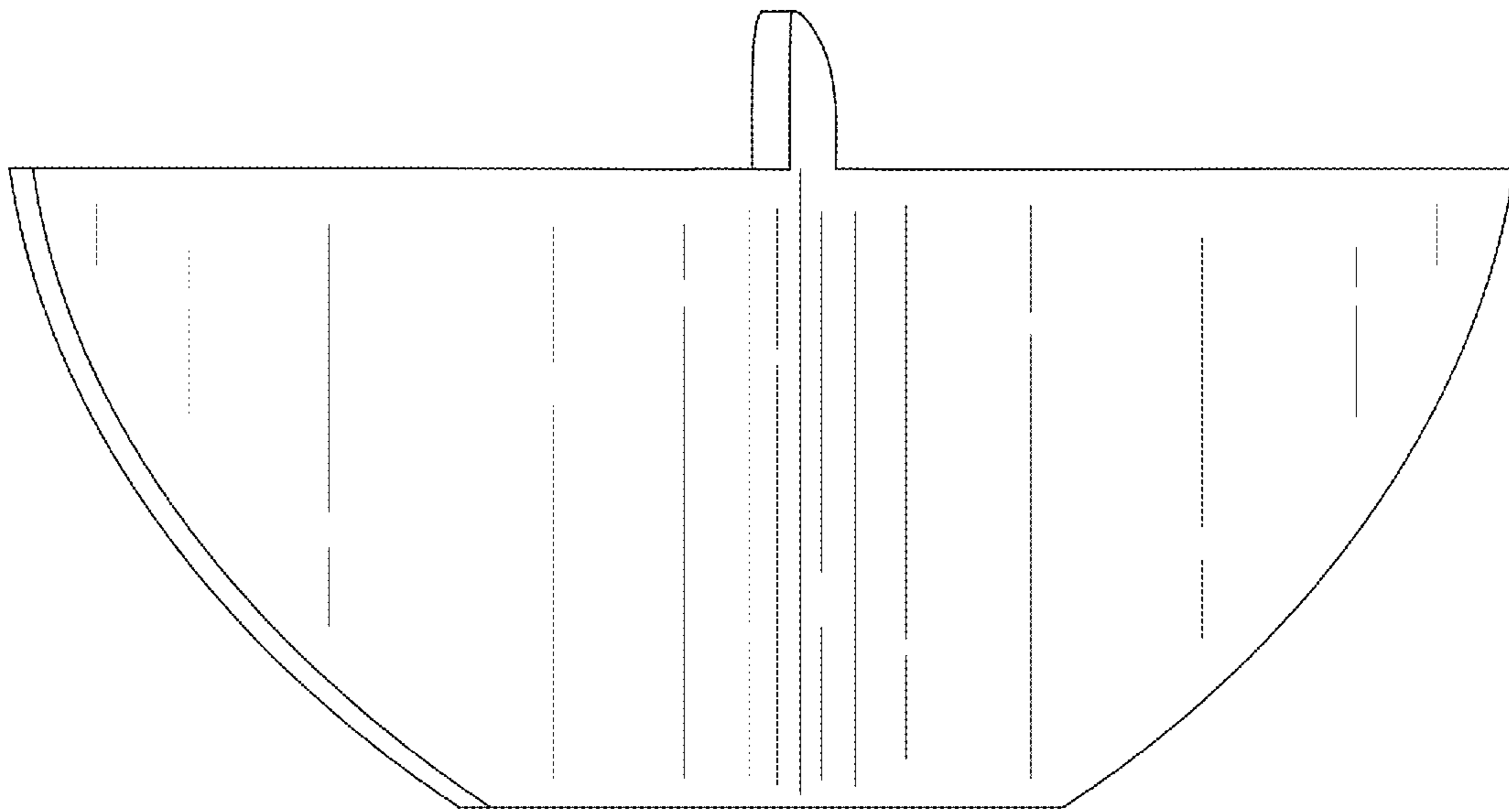

FIG. 4

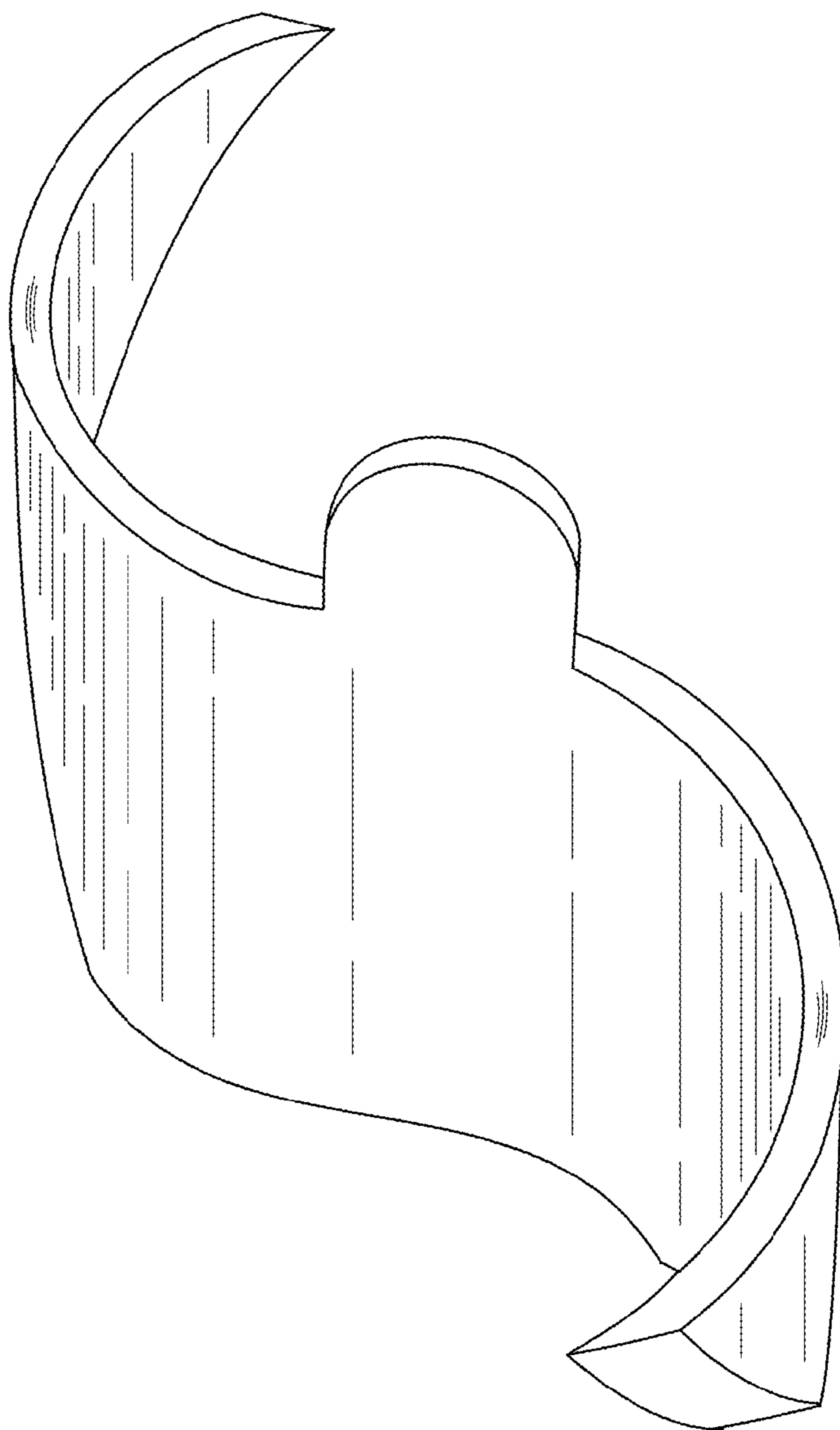

FIG. 5

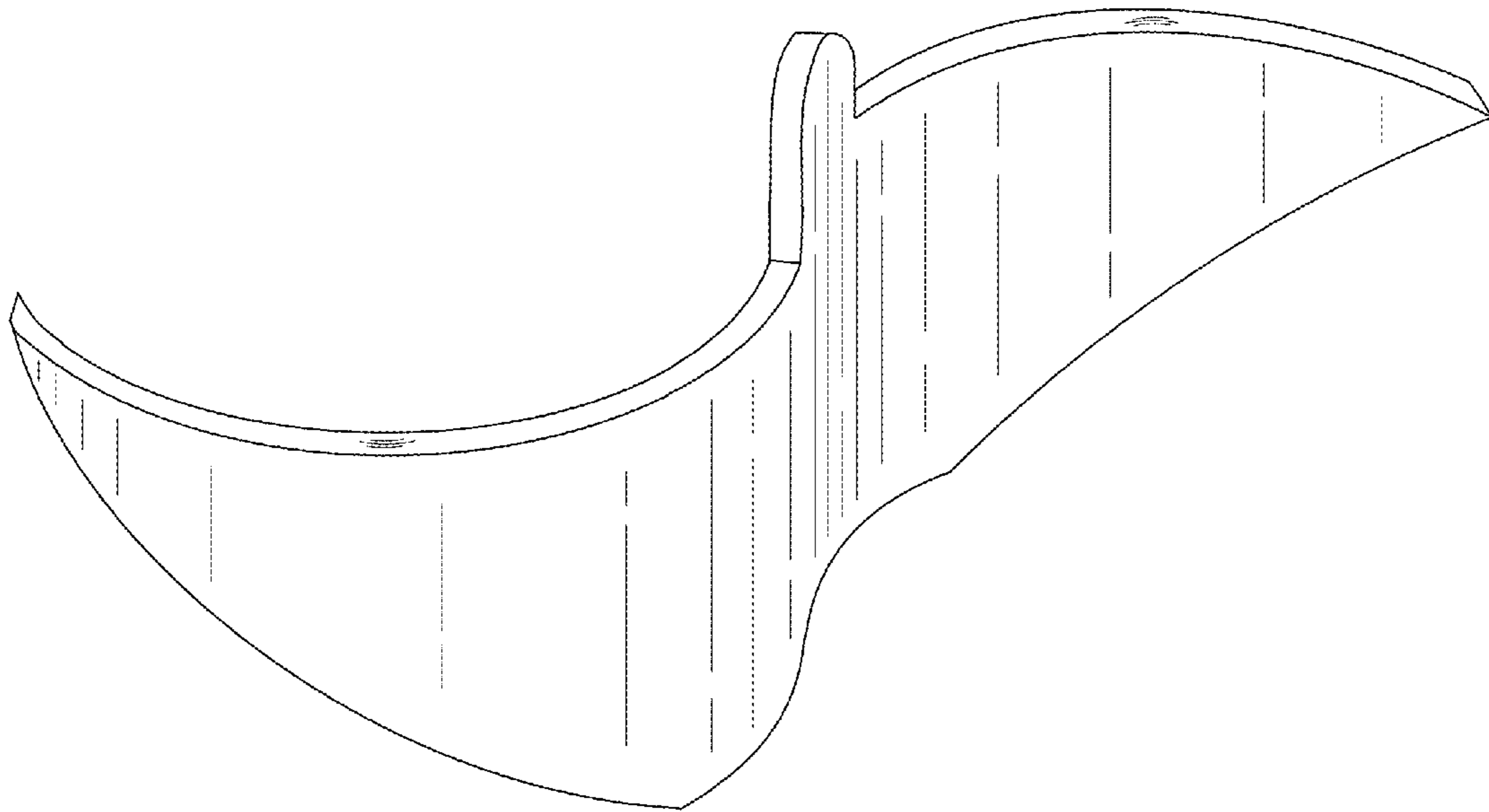

FIG. 6