



US00D683593S

(12) **United States Design Patent**
Pilgaard

(10) **Patent No.:** **US D683,593 S**

(45) **Date of Patent:** **** Jun. 4, 2013**

(54) **SERVING TRAY WITH COOLING
ELEMENTS FOR CANS, BOTTLES, OR FOOD**

D625,886 S * 10/2010 Ellard D30/131
7,878,337 B2 * 2/2011 Abdullah 211/10
D650,862 S * 12/2011 Chuang D19/77

(75) Inventor: **Ebbe Pilgaard**, Faarup (DK)

* cited by examiner

(73) Assignee: **Pipidipi ApS**, Faarup (DK)

Primary Examiner — Kelley Donnelly

(74) *Attorney, Agent, or Firm* — William J. Sapone; Ware
Fressola Maguire & Barber LLP

(**) Term: **14 Years**

(21) Appl. No.: **29/408,587**

(57) **CLAIM**

I claim the ornamental design for a serving tray with cooling
elements for cans, bottles or food, as shown and described.

(22) Filed: **Dec. 14, 2011**

DESCRIPTION

(51) **LOC (9) Cl.** **07-01**

(52) **U.S. Cl.**
USPC **D7/553.6**

(58) **Field of Classification Search**
USPC D7/550.1, 553.1, 553.6, 553.7, 554.2,
D7/566, 586–587; D19/75–79, 95;
206/558–567; 220/574–575

See application file for complete search history.

FIG. 1 is a perspective view of the serving tray with cooling
elements for cans, bottles or food, showing my new design;
FIG. 2 is an exploded perspective view of the serving tray
with cooling elements for cans, bottles or food thereof show-
ing the handle in the folded position;
FIG. 3 is a front view of the serving tray with cooling ele-
ments for cans, bottles or food of FIG. 1, showing the handle
in an upright position, the rear view being a mirror image
thereof;
FIG. 4 is a top view thereof;
FIG. 5 is a right side view of the serving tray with cooling
elements for cans, bottles or food, with the rotatable handle in
a storage position, the left side view being a mirror image
thereof; and,

(56) **References Cited**

U.S. PATENT DOCUMENTS

3,489,289	A *	1/1970	Scott-Fenton	211/78
D377,807	S *	2/1997	Green et al.	D19/77
D418,947	S *	1/2000	Greiner	D28/73
D432,916	S *	10/2000	Drinkwater et al.	D9/447
D444,676	S *	7/2001	Murphy	D7/553.6
D566,770	S *	4/2008	Cetera	D19/77
D575,986	S *	9/2008	Cetera	D7/501
7,552,697	B2 *	6/2009	Busse	119/53
7,647,888	B2 *	1/2010	Slankard et al.	119/53
D619,364	S *	7/2010	Barrick et al.	D3/315

FIG. 6 is a right side view of the serving tray with cooling
elements for cans, bottles or food, with the rotatable handle in
the upright position, the left side view being a mirror image
thereof.

The portions of the serving tray for cans, bottles or food
shown in broken lines form no part of the claimed design.

1 Claim, 6 Drawing Sheets

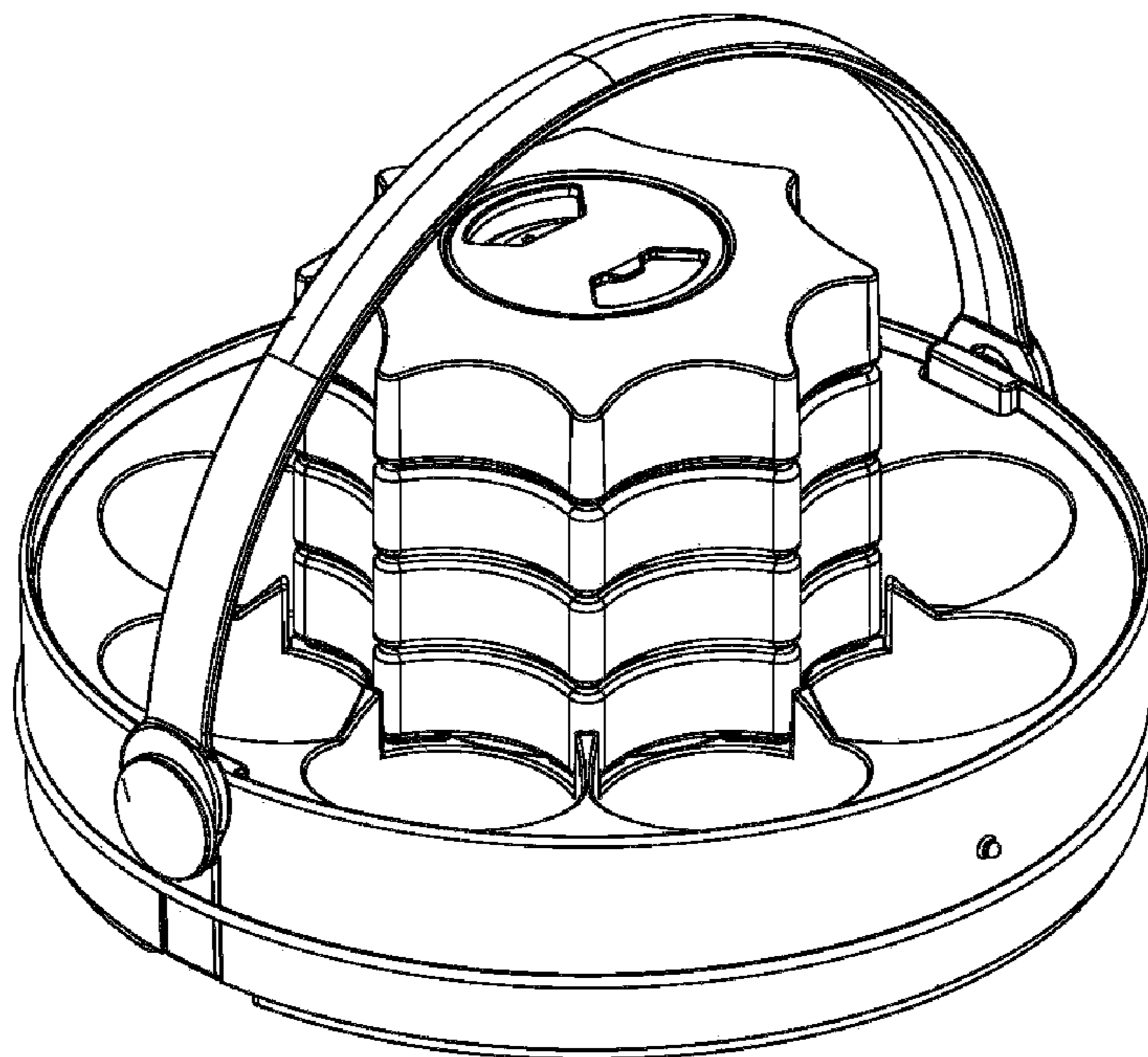

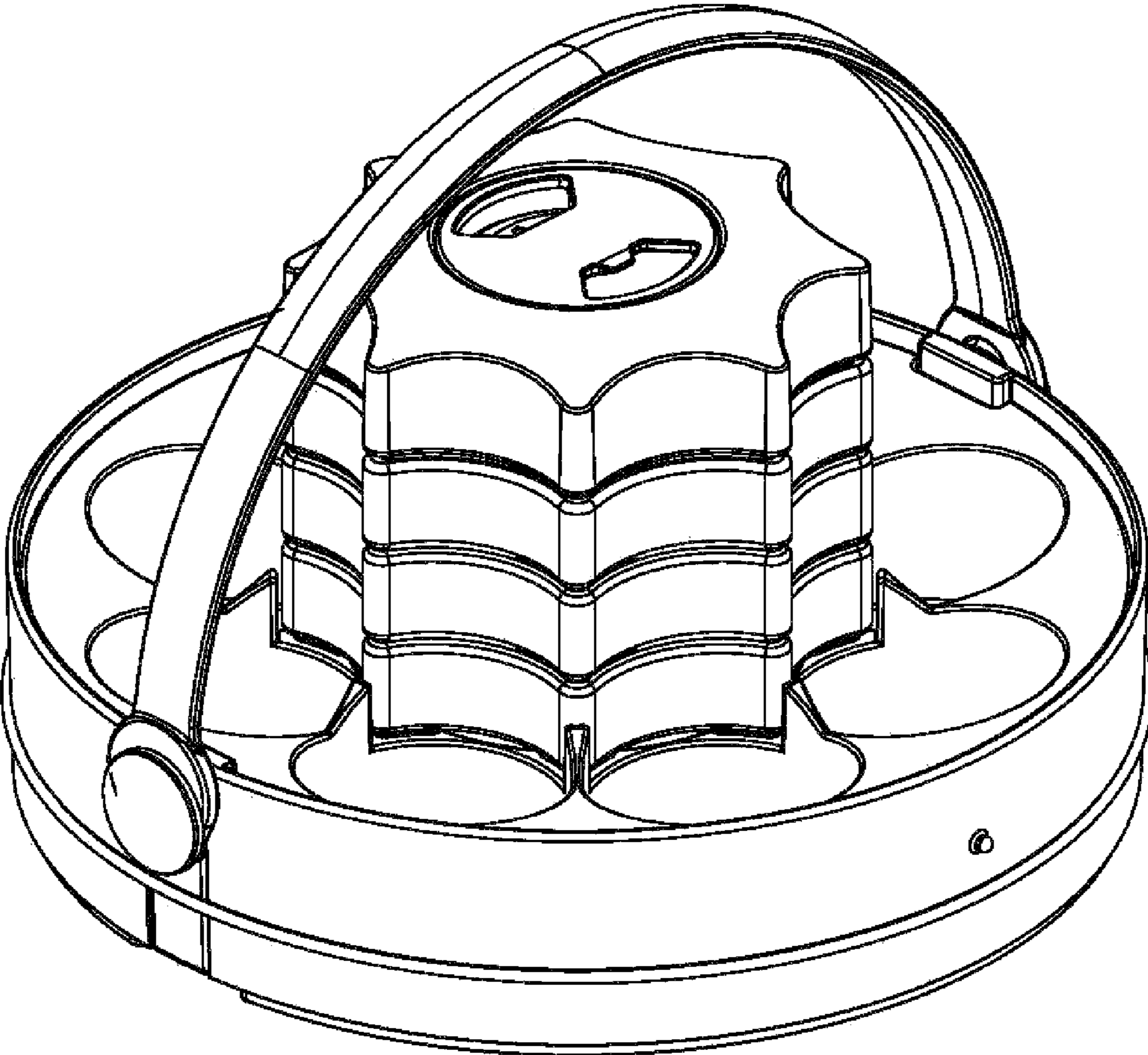

Fig. 1

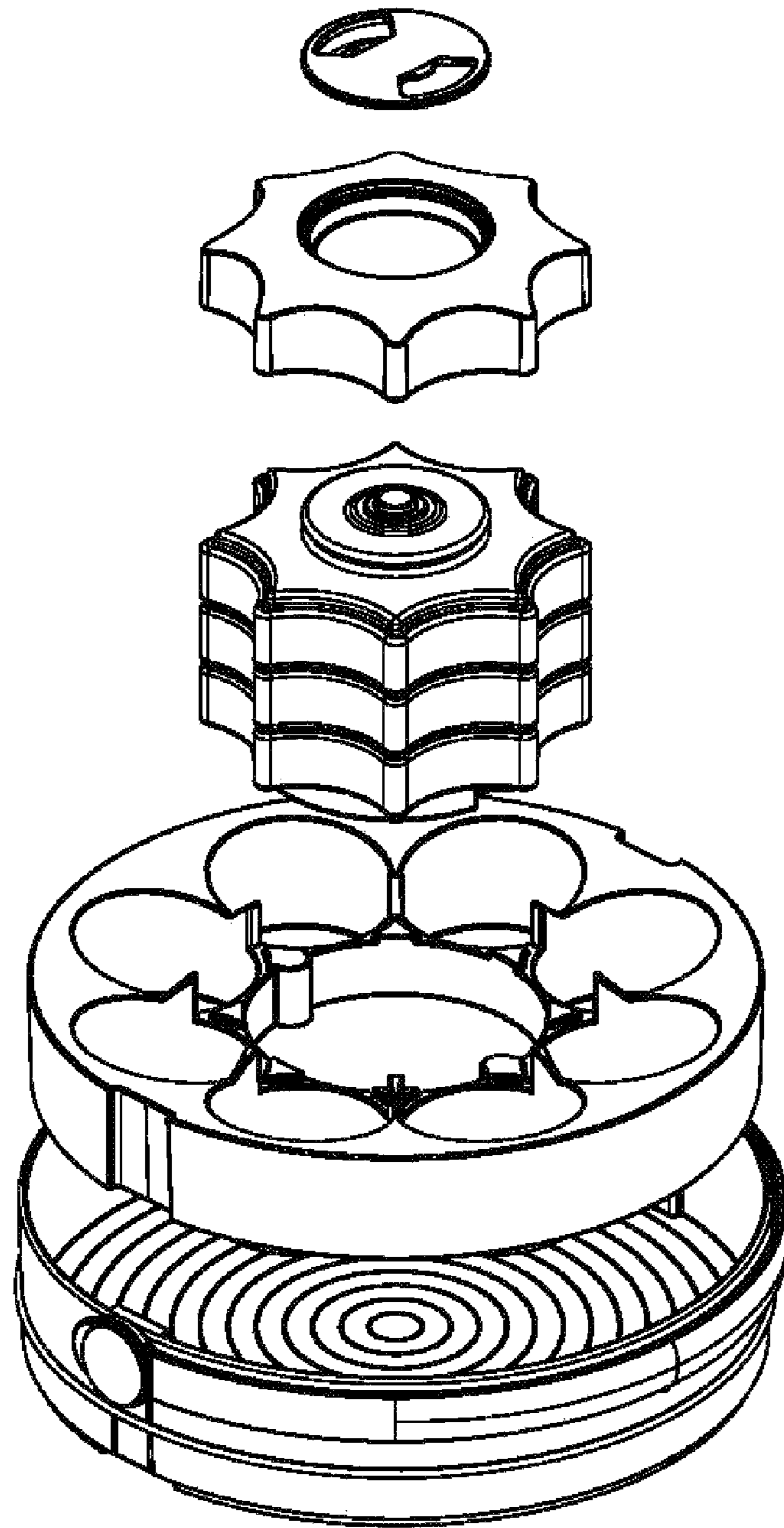

Fig. 2

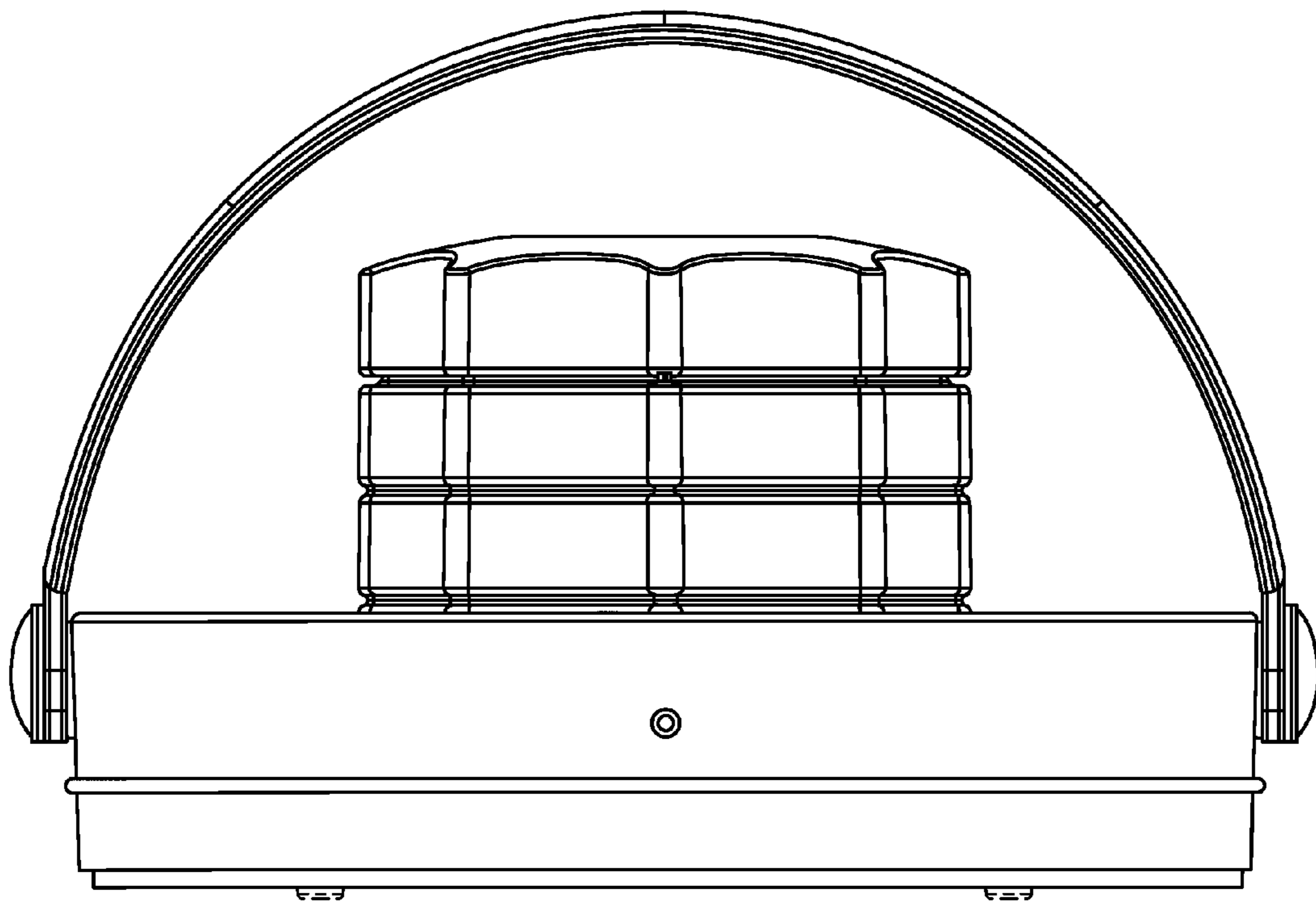

Fig. 3

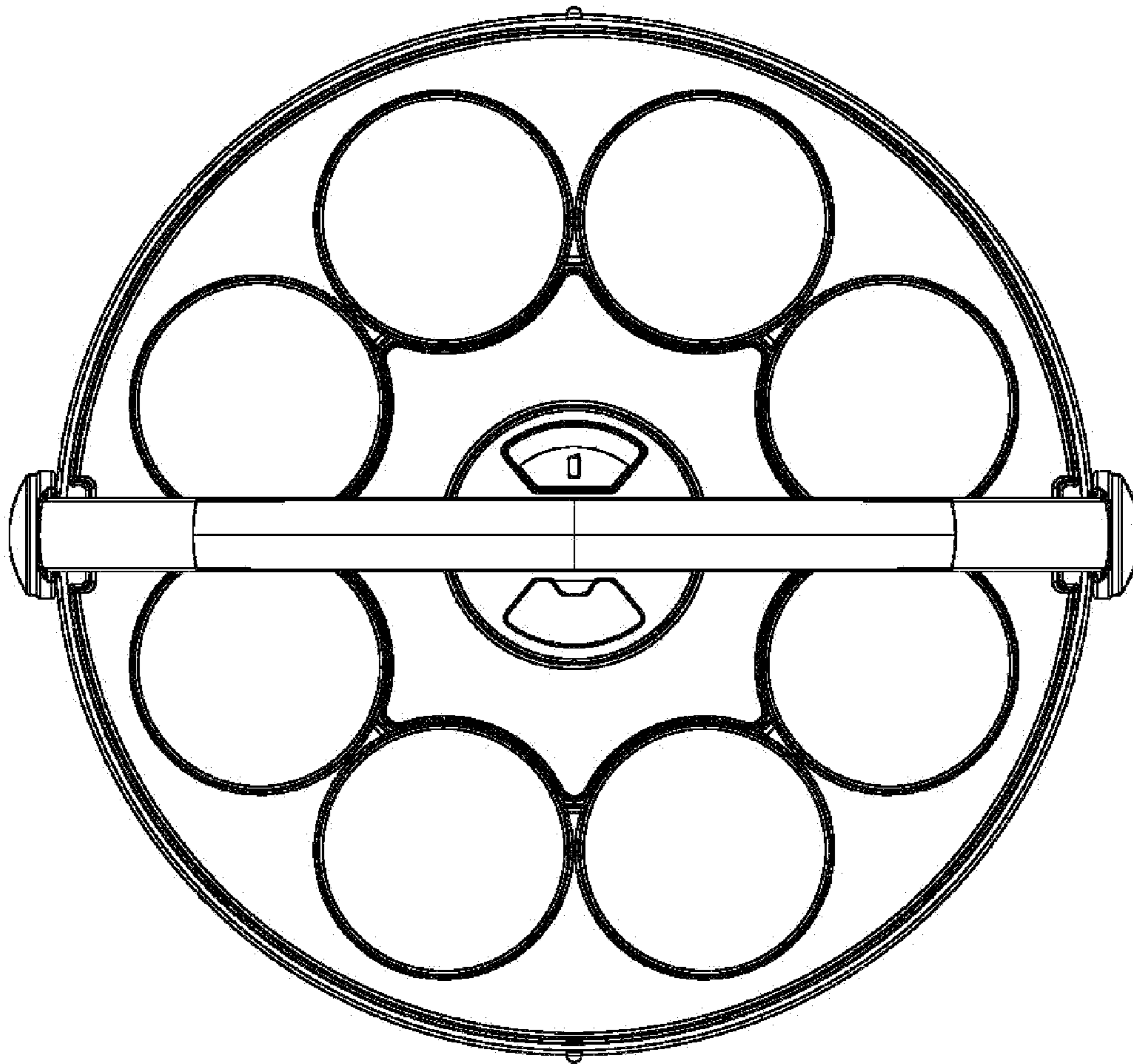

Fig. 4

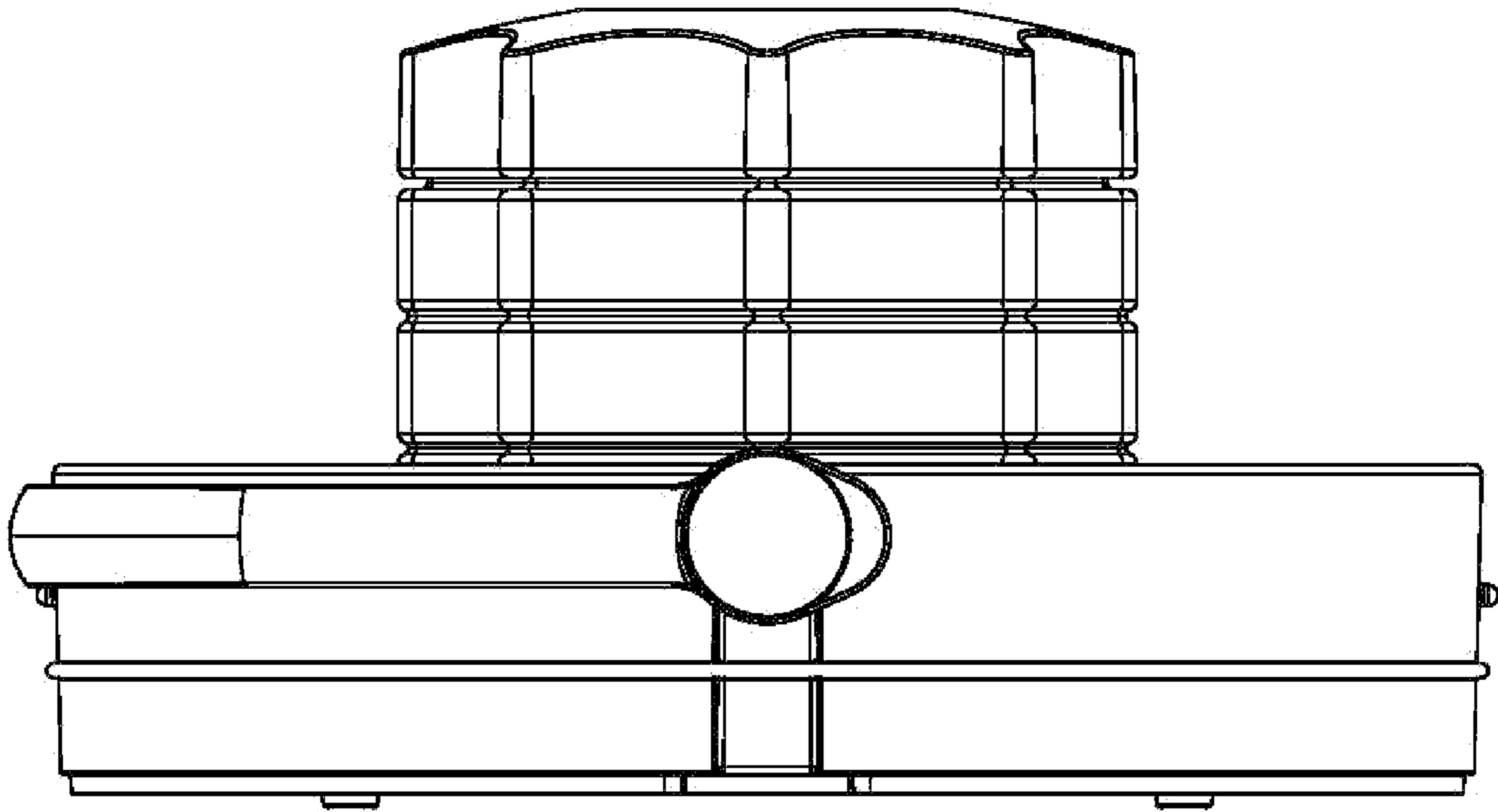

Fig. 5

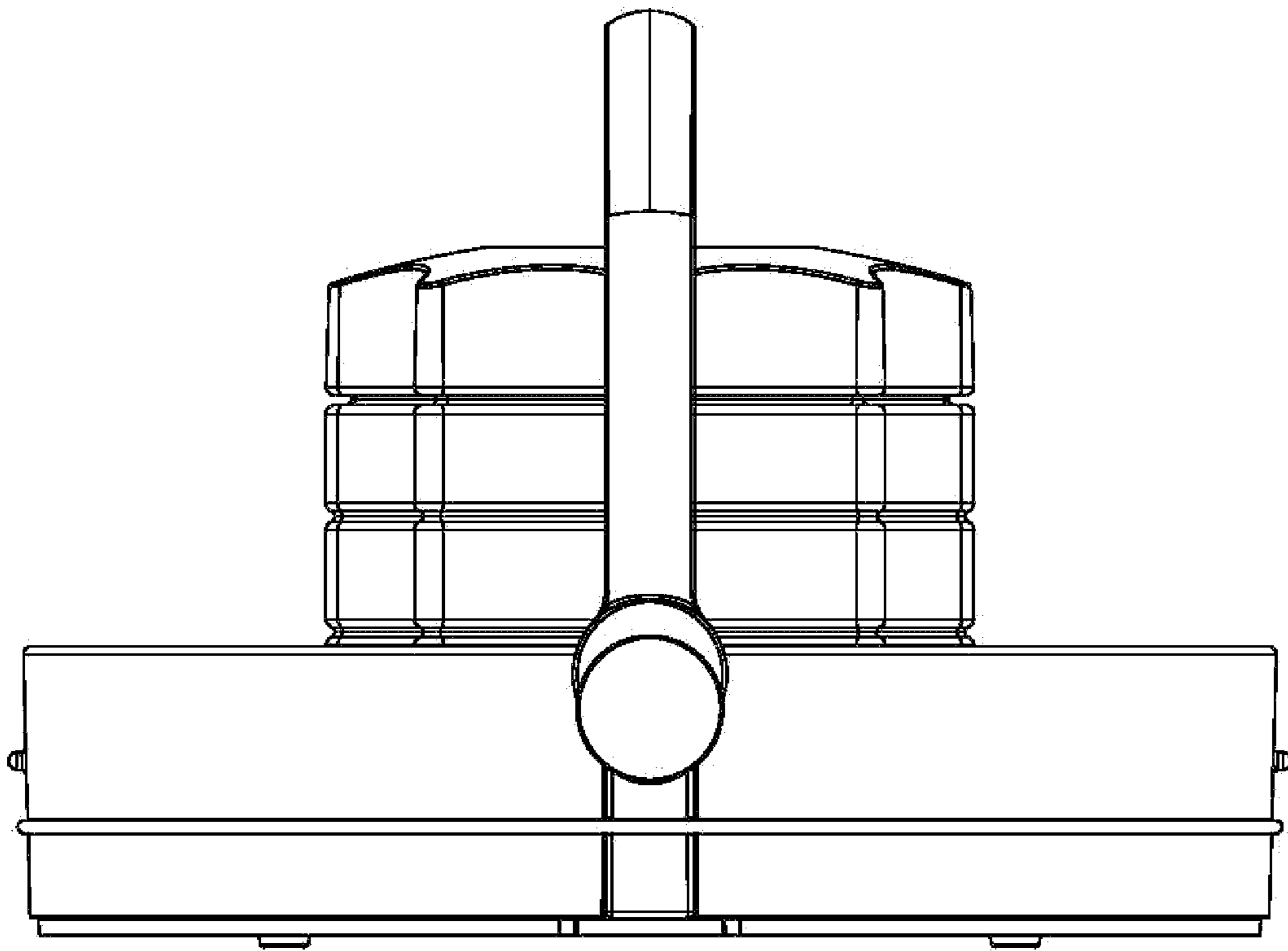

Fig. 6