



US00D683497S

(12) **United States Design Patent**
Ghiotti et al.

(10) **Patent No.:** **US D683,497 S**

(45) **Date of Patent:** **** May 28, 2013**

(54) **CONTAINER FOR POUCHES OF SMOKELESS TOBACCO**

(75) Inventors: **Roberto Ghiotti**, Calderino di Monte San Pietro (IT); **Fulvio Boldrini**, Ferrara (IT)

(73) Assignee: **Azionaria Costruzioni Macchine Automatiche A.C.M.A. S.p.A.** (IT)

(**) Term: **14 Years**

(21) Appl. No.: **29/388,818**

(22) Filed: **Apr. 1, 2011**

Related U.S. Application Data

(62) Division of application No. 29/365,192, filed on Jul. 6, 2010, now Pat. No. Des. 637,903.

(30) **Foreign Application Priority Data**

Jan. 21, 2010 (IT) BO2010O0001

(51) **LOC (9) Cl.** **27-06**

(52) **U.S. Cl.**
USPC **D27/186; D9/428**

(58) **Field of Classification Search**
USPC D27/172, 183, 184, 185, 186, 187, D27/189, 190, 191, 193; 131/112, 240.1, 131/241, 242, 329; D9/428, 756, 504, 737, D9/738, 772, 779, 780; 206/256, 242, 265, 206/37; D3/203.2, 203.3

See application file for complete search history.

(56) **References Cited**

U.S. PATENT DOCUMENTS

700,395 A * 5/1902 Wilcox 206/256
D167,554 S * 8/1952 Bergman D27/121

(Continued)

Primary Examiner — Robert M Spear

Assistant Examiner — Janice Hallmark

(74) *Attorney, Agent, or Firm* — Timothy J. Klima; Shuttleworth & Ingersoll, PLC

(57) **CLAIM**

The ornamental design for a container for pouches of smokeless tobacco, as shown and described.

DESCRIPTION

FIG. 1 is an exploded perspective view of a first embodiment of a container for pouches of smokeless tobacco showing our new design;

FIG. 2 is a top plan view thereof without the lid;

FIG. 3 is a side view thereof without the lid;

FIG. 4 is a side view thereof with the lid;

FIG. 5 is a top plan view of the container, shown without the lid and illustrating the pouches of tobacco ready for use;

FIG. 6 is an exploded perspective view of a second embodiment of a container for pouches of smokeless tobacco showing our new design;

FIG. 7 is a top plan view thereof without the lid;

FIG. 8 is a side view thereof without the lid;

FIG. 9 is a side view thereof with the lid;

FIG. 10 is a top plan view of the container, shown without the lid and illustrating the pouches of tobacco ready for use;

FIG. 11 is an exploded perspective view of a third embodiment of a container for pouches of smokeless tobacco showing our new design;

FIG. 12 is a top plan view thereof without the lid;

FIG. 13 is a side view thereof without the lid;

FIG. 14 is a side view thereof with the lid; and,

FIG. 15 is a top plan view of the container, shown without the lid and illustrating the pouches of tobacco ready for use.

The broken lines in the drawings represent unclaimed environmental subject matter.

1 Claim, 3 Drawing Sheets

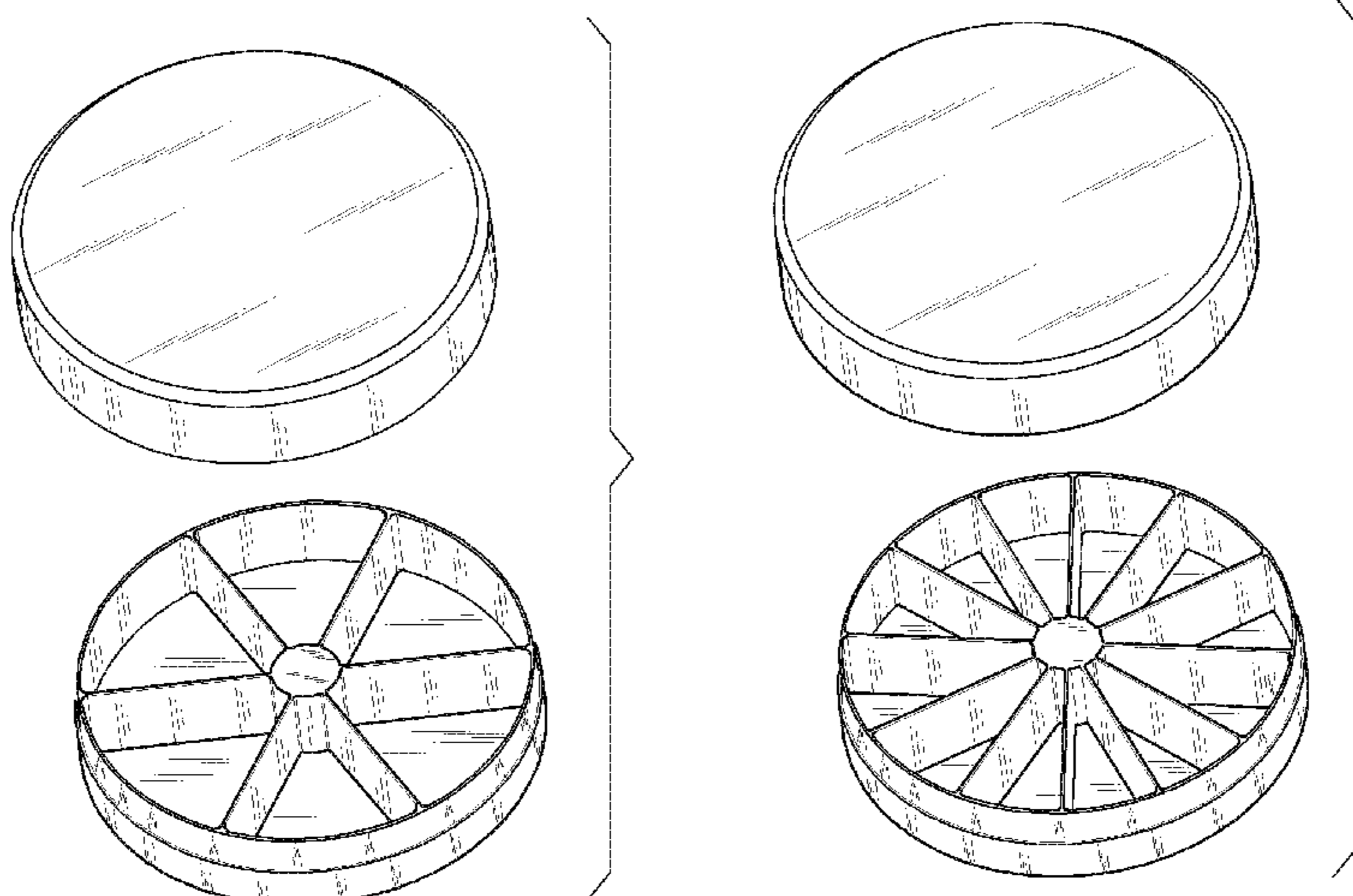

US D683,497 S

Page 2

U.S. PATENT DOCUMENTS

| | | | | | | | | | |
|-----------|------|---------|-----------------------|----------|--------------|------|--------|---------------------------|---------|
| 4,646,933 | A * | 3/1987 | Jurczenia et al. | 220/799 | D641,257 | S * | 7/2011 | Thiebaut et al. | D9/738 |
| 4,804,101 | A * | 2/1989 | Heath | 220/504 | D651,519 | S * | 1/2012 | Gibson et al. | D9/529 |
| D451,666 | S * | 12/2001 | Zastrow | D3/203.3 | D660,693 | S * | 5/2012 | Berggren | D9/428 |
| D494,474 | S * | 8/2004 | Houk et al. | D9/504 | D664,840 | S * | 8/2012 | Jones et al. | D9/423 |
| D510,524 | S * | 10/2005 | Houk et al. | D9/503 | 8,250,975 | B2 * | 8/2012 | Cronin et al. | 100/233 |
| D531,036 | S * | 10/2006 | Bried et al. | D9/504 | 2005/0173272 | A1 * | 8/2005 | Lemmons | 206/256 |
| D581,809 | S * | 12/2008 | Wichowski | D9/772 | 2006/0018786 | A1 * | 1/2006 | Tolman et al. | 422/5 |
| D600,441 | S * | 9/2009 | Estrada | D3/203.3 | 2006/0060480 | A1 * | 3/2006 | Budd | 206/266 |
| D603,698 | S * | 11/2009 | VerWeyst | D9/500 | 2010/0043812 | A1 * | 2/2010 | Yount | 131/329 |
| 7,798,319 | B1 * | 9/2010 | Bried et al. | 206/242 | 2010/0065076 | A1 * | 3/2010 | Bergstrom et al. | 131/329 |
| D626,687 | S * | 11/2010 | Gibson et al. | D27/183 | 2010/0065077 | A1 * | 3/2010 | Lofgreen-Ohrn et al. | 131/329 |
| D637,903 | S * | 5/2011 | Ghiotti et al. | D9/428 | | | | | |

* cited by examiner

FIG.1

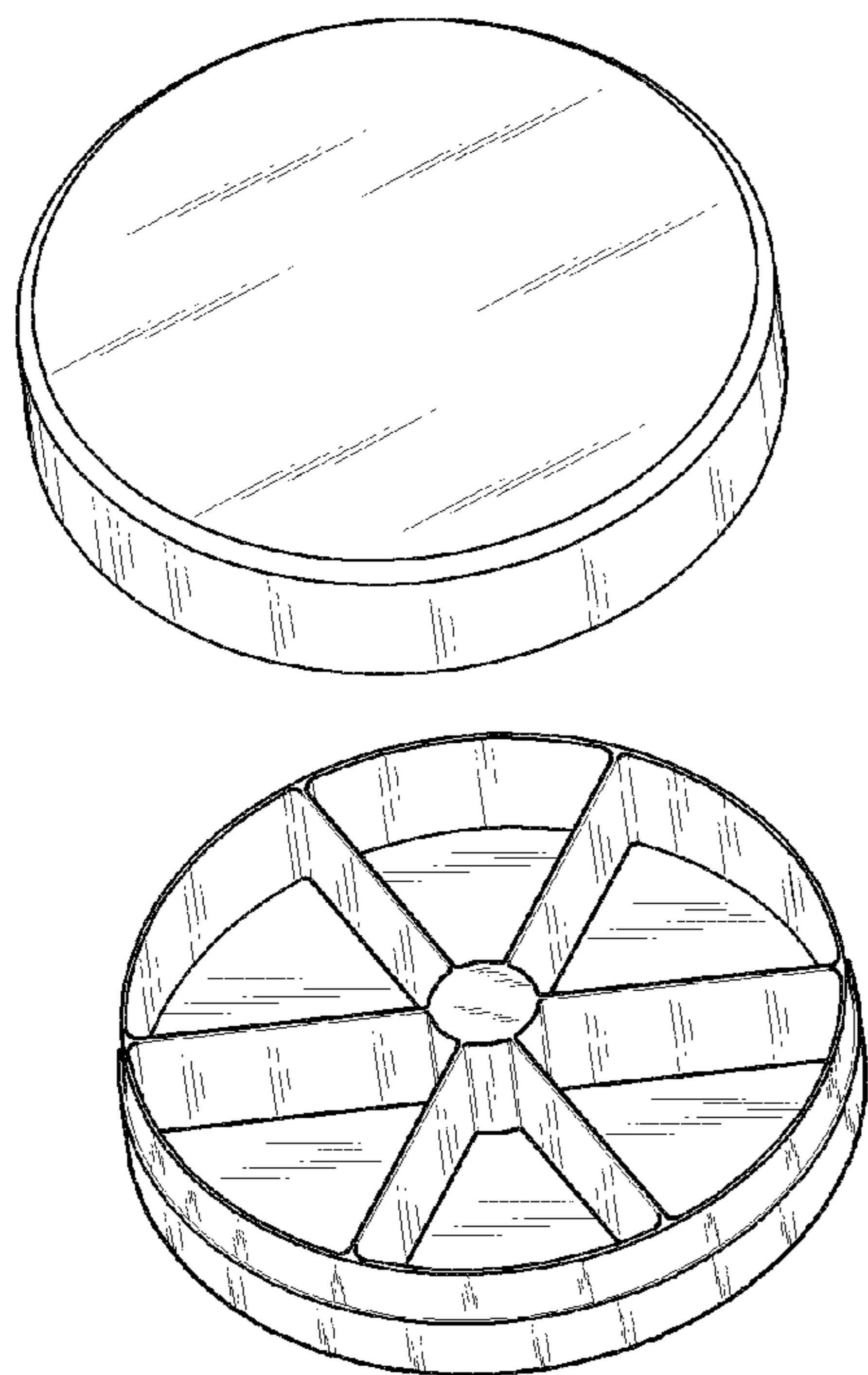

FIG.2

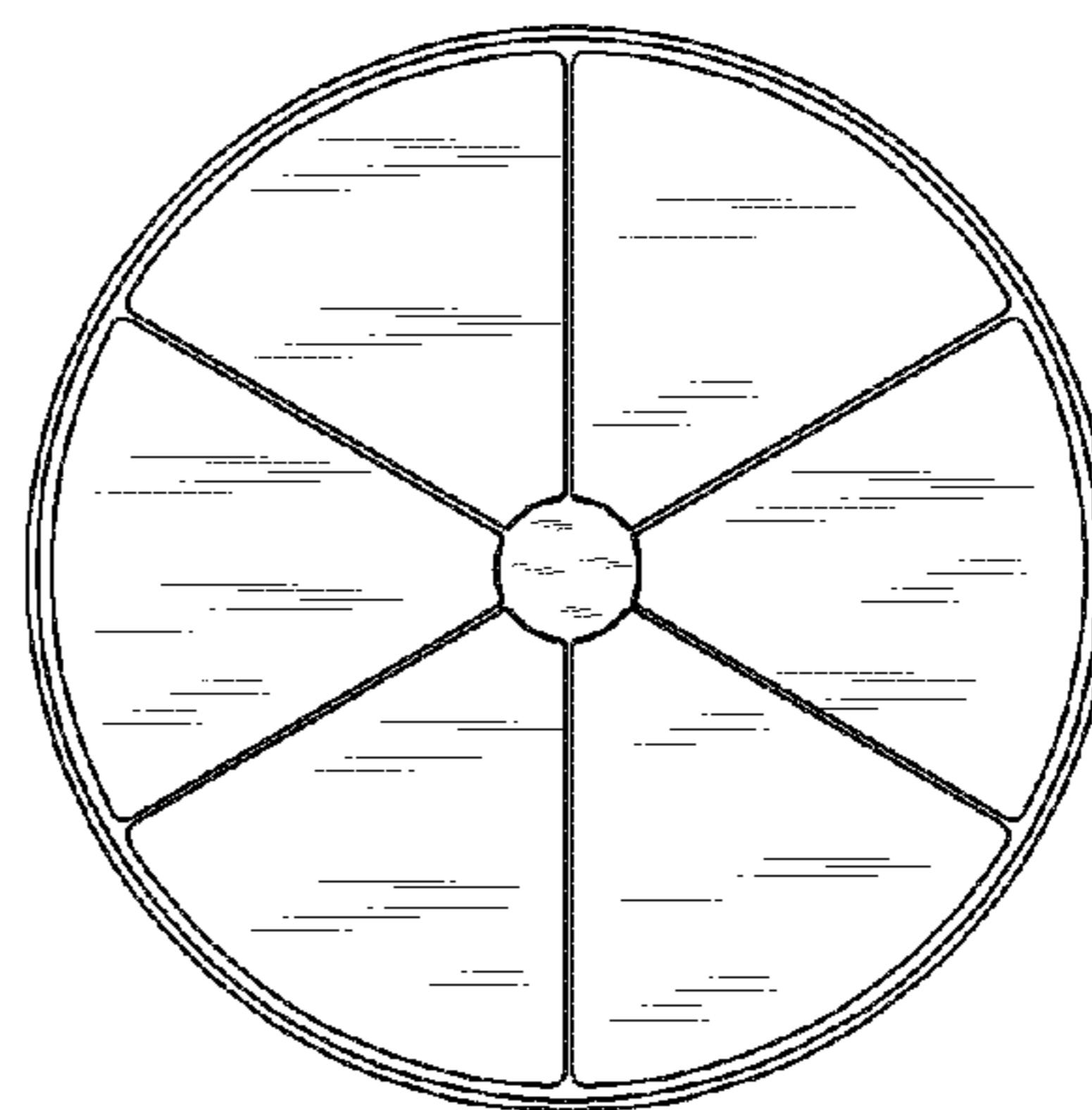

FIG.3

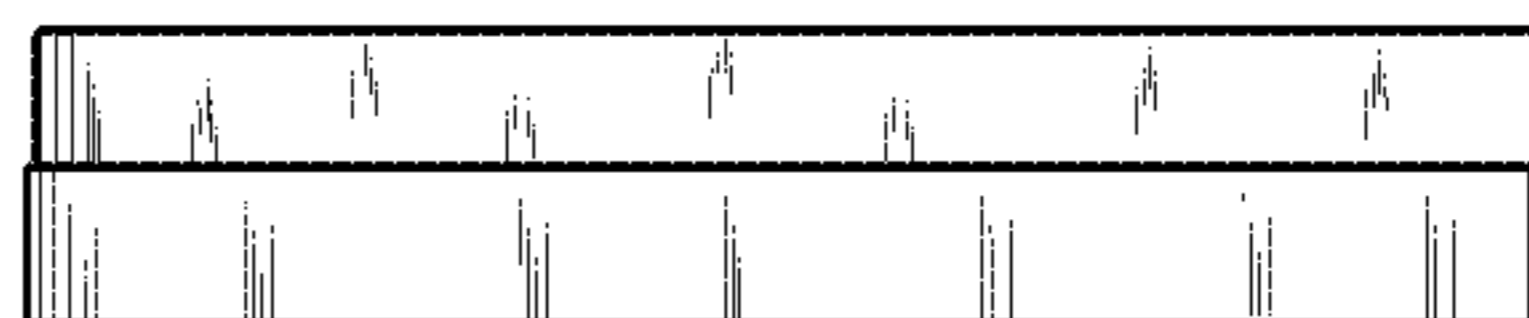

FIG.4

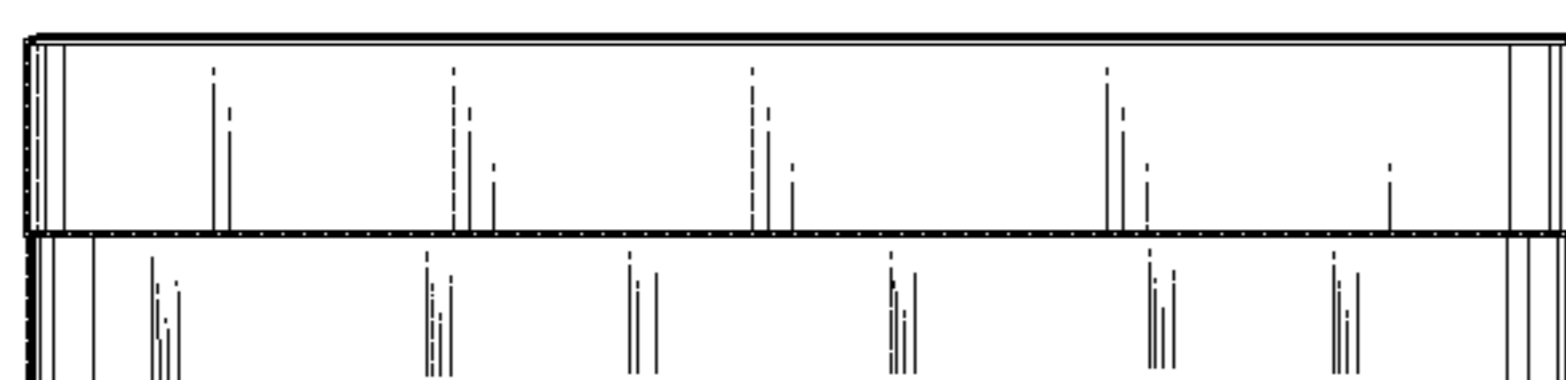

FIG.5

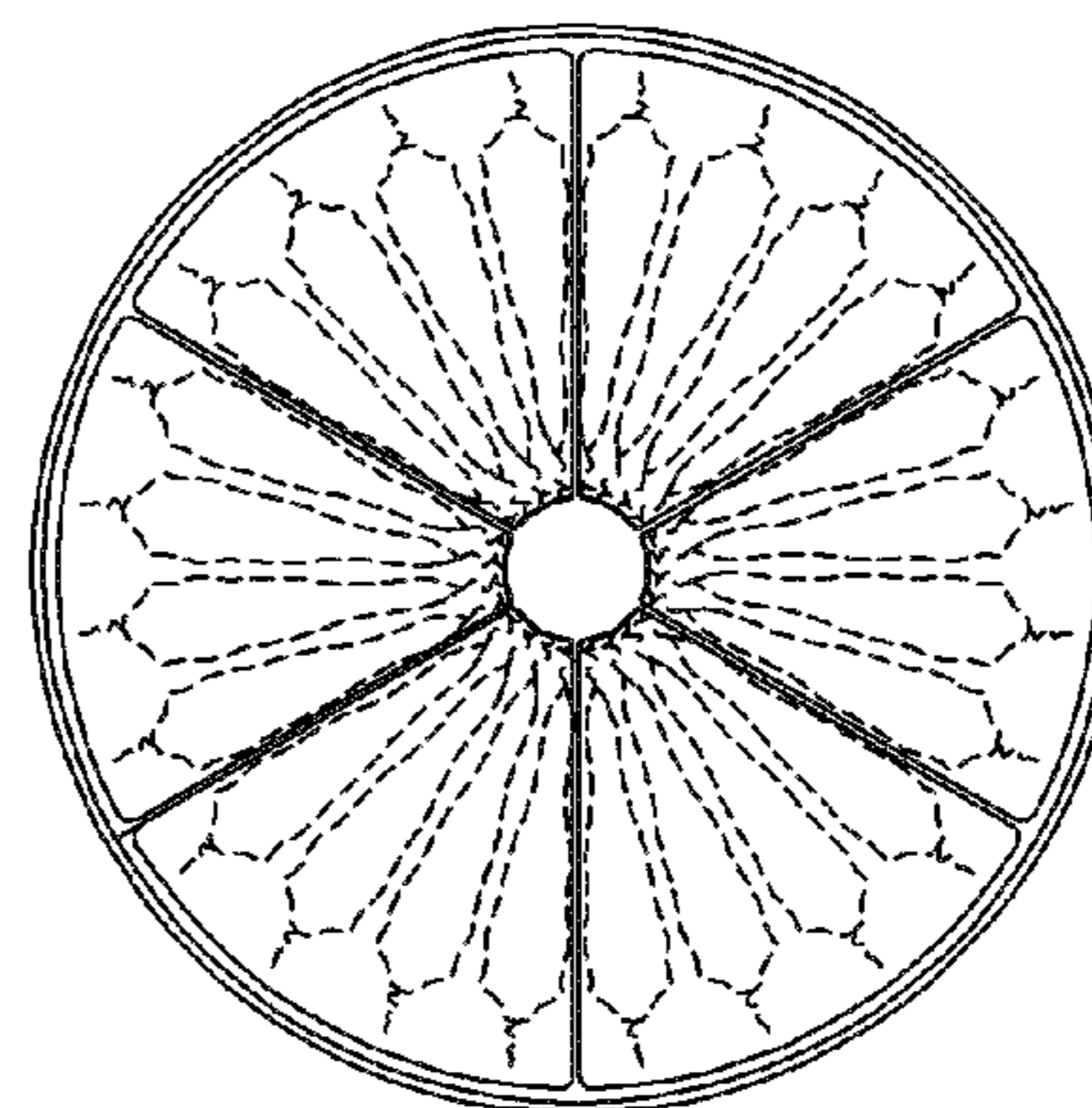

FIG.6

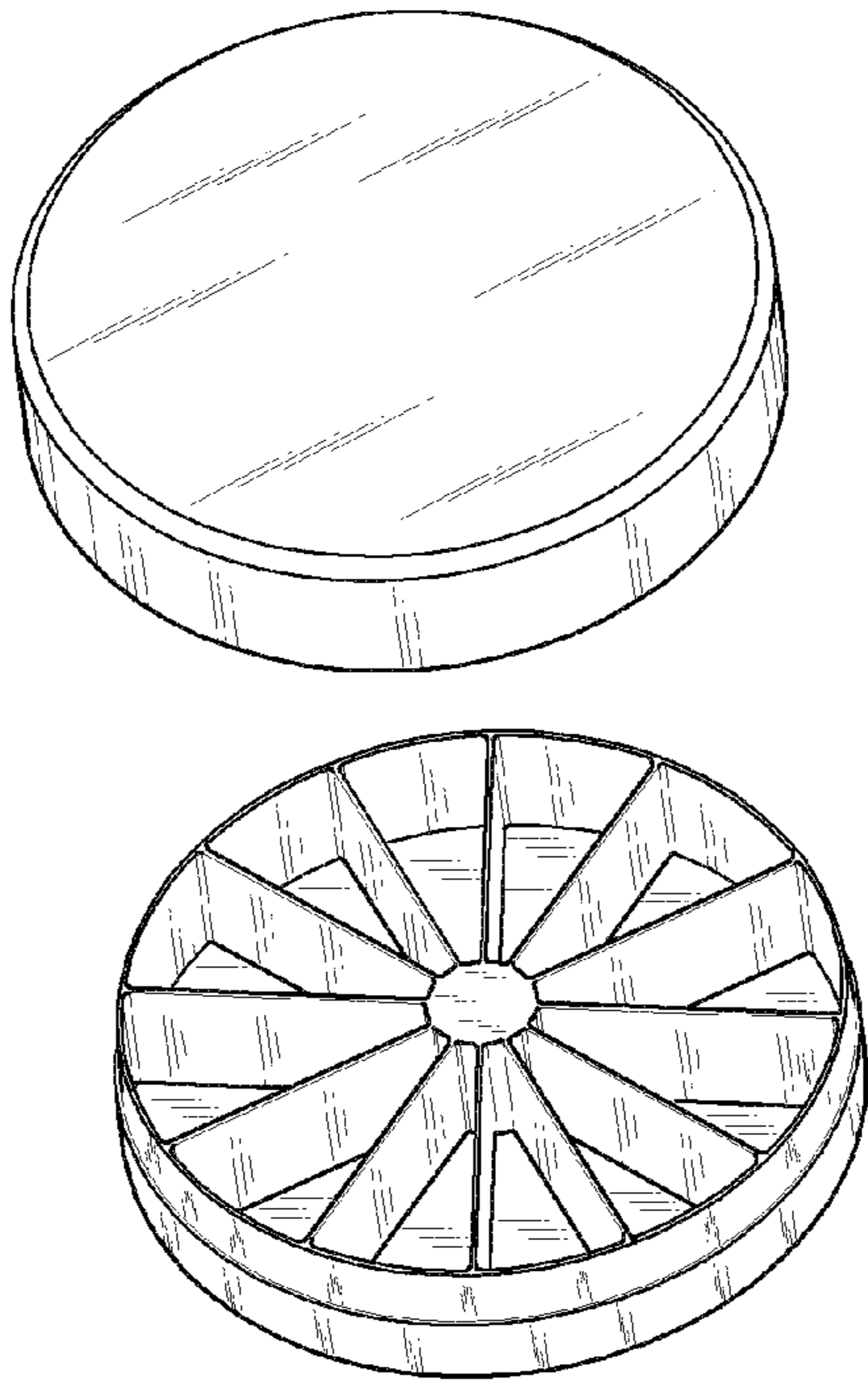

FIG.7

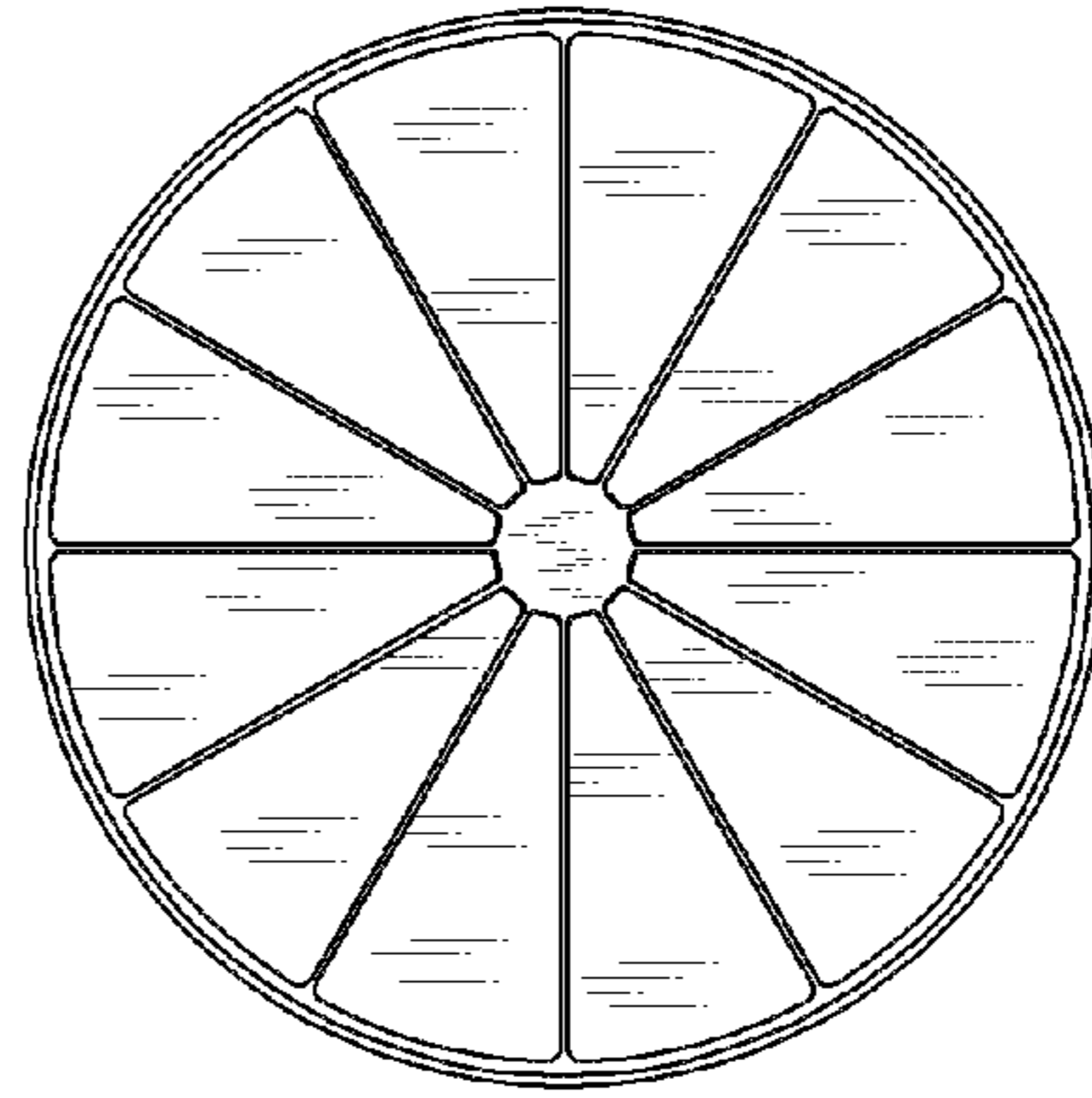

FIG.8

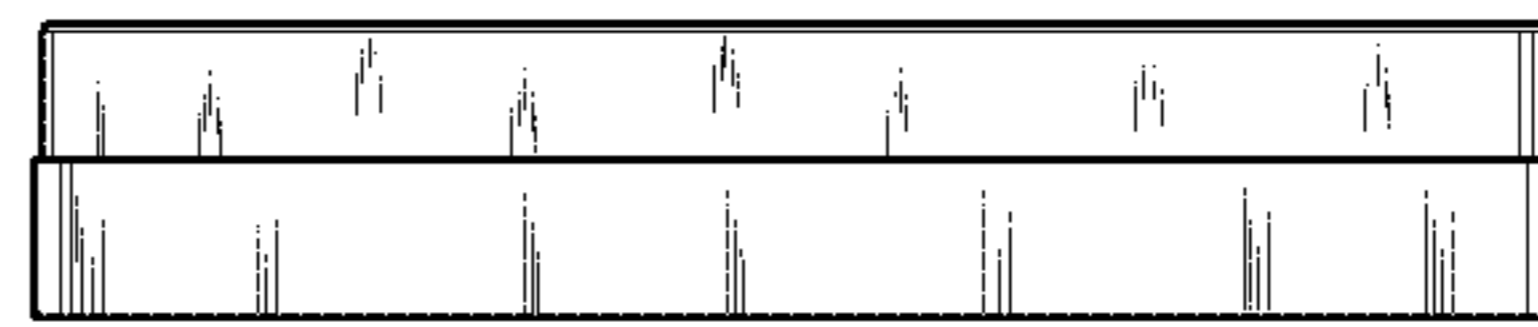

FIG.10

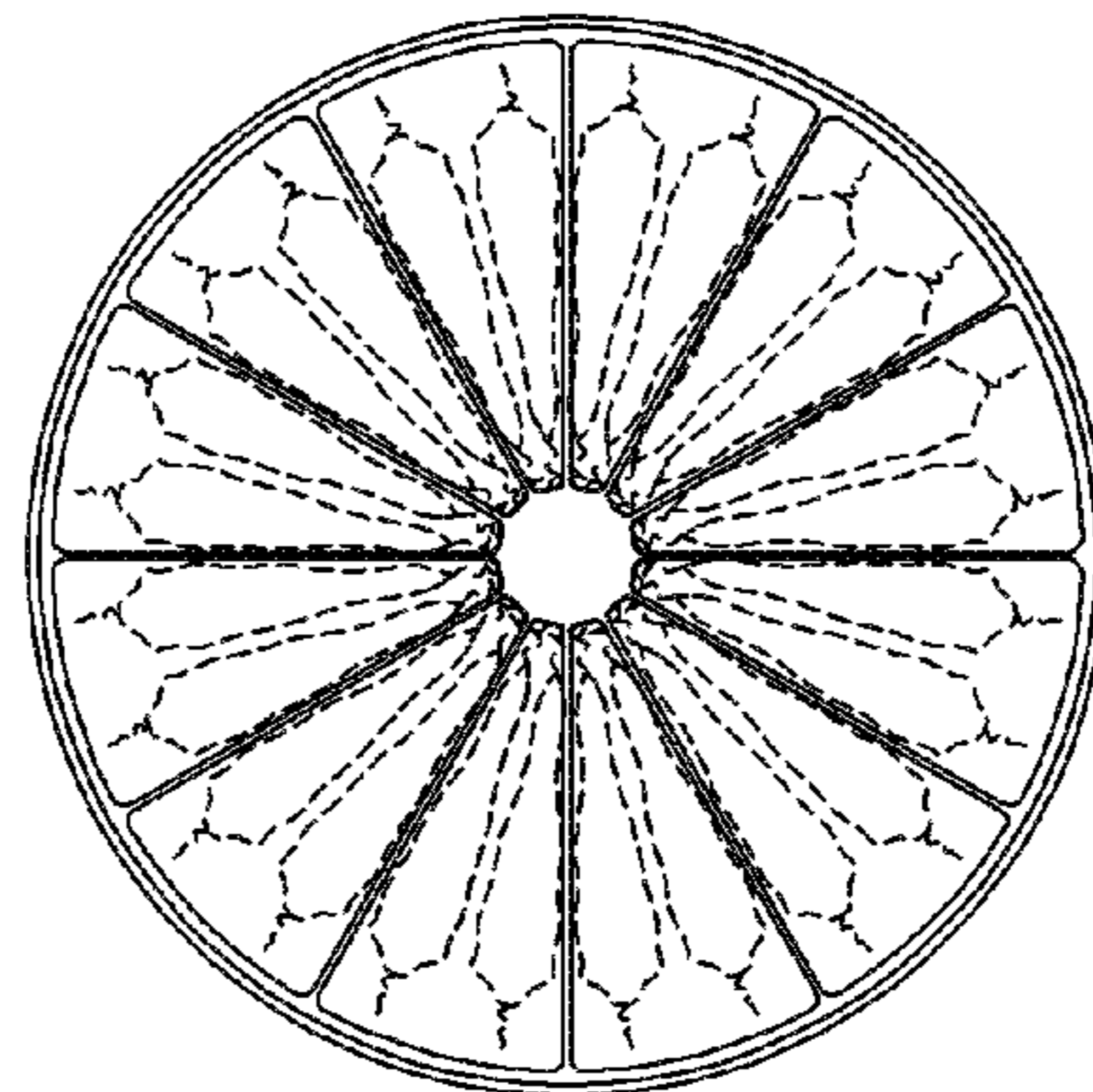

FIG.9

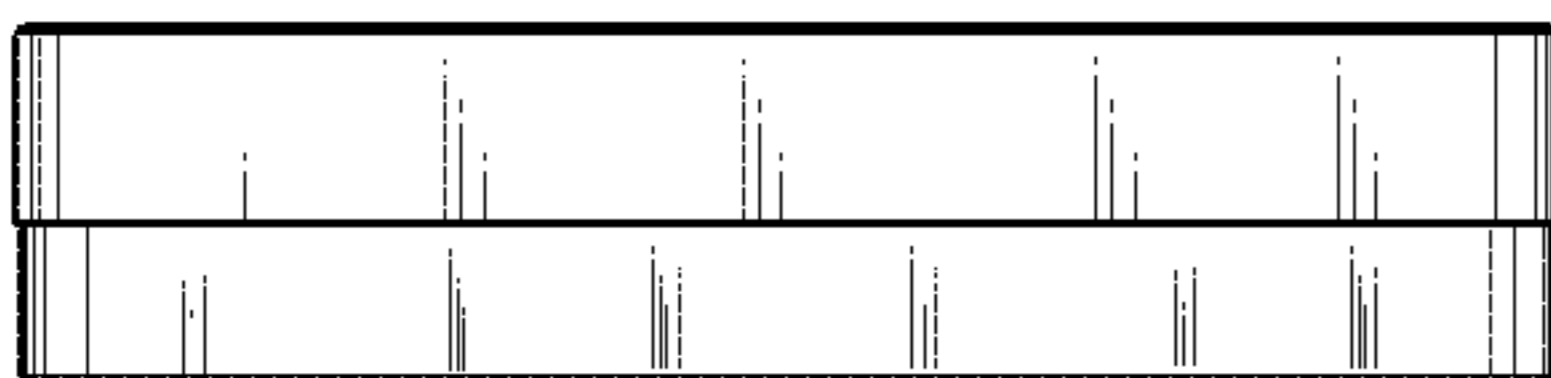

FIG.11

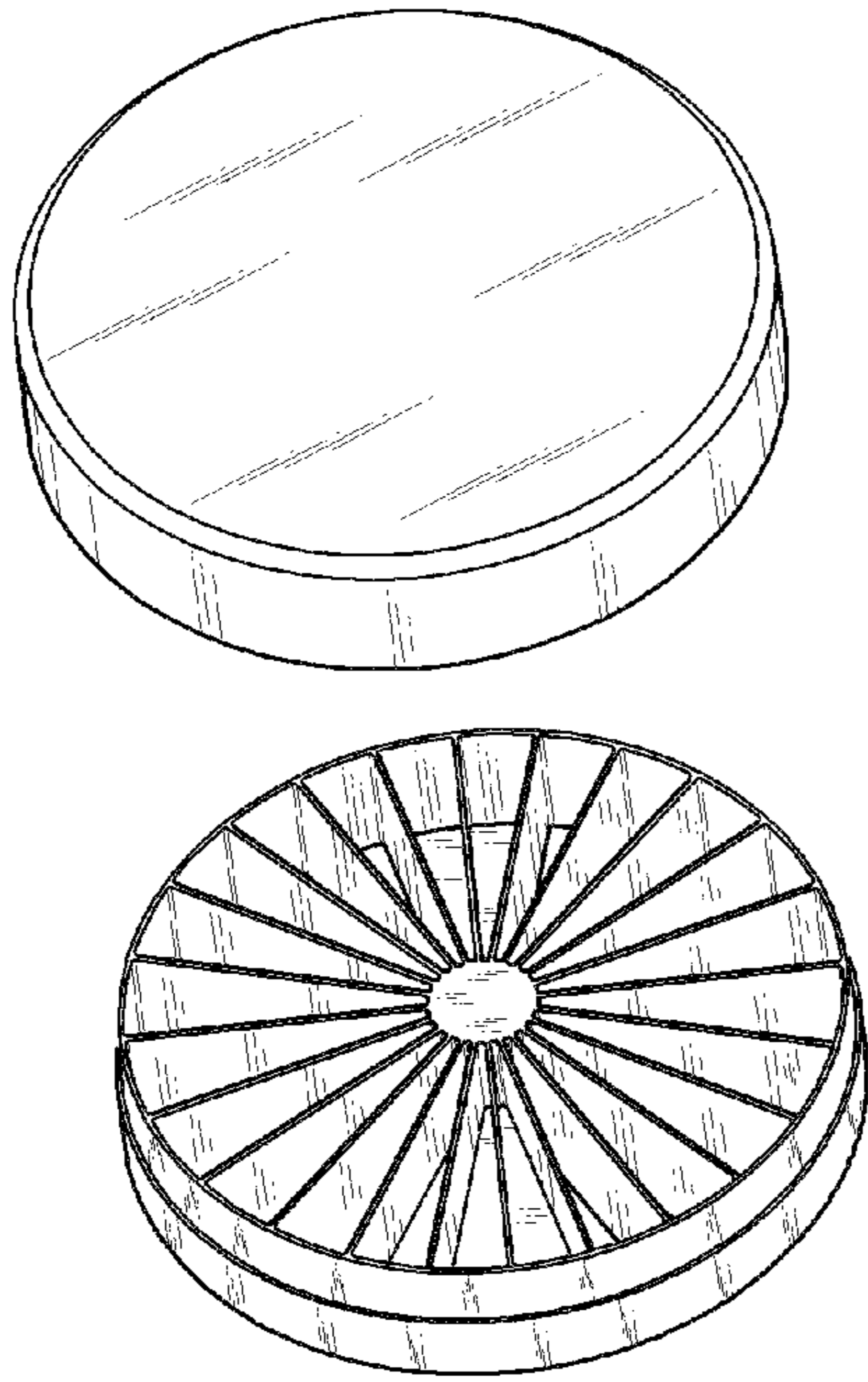

FIG.12

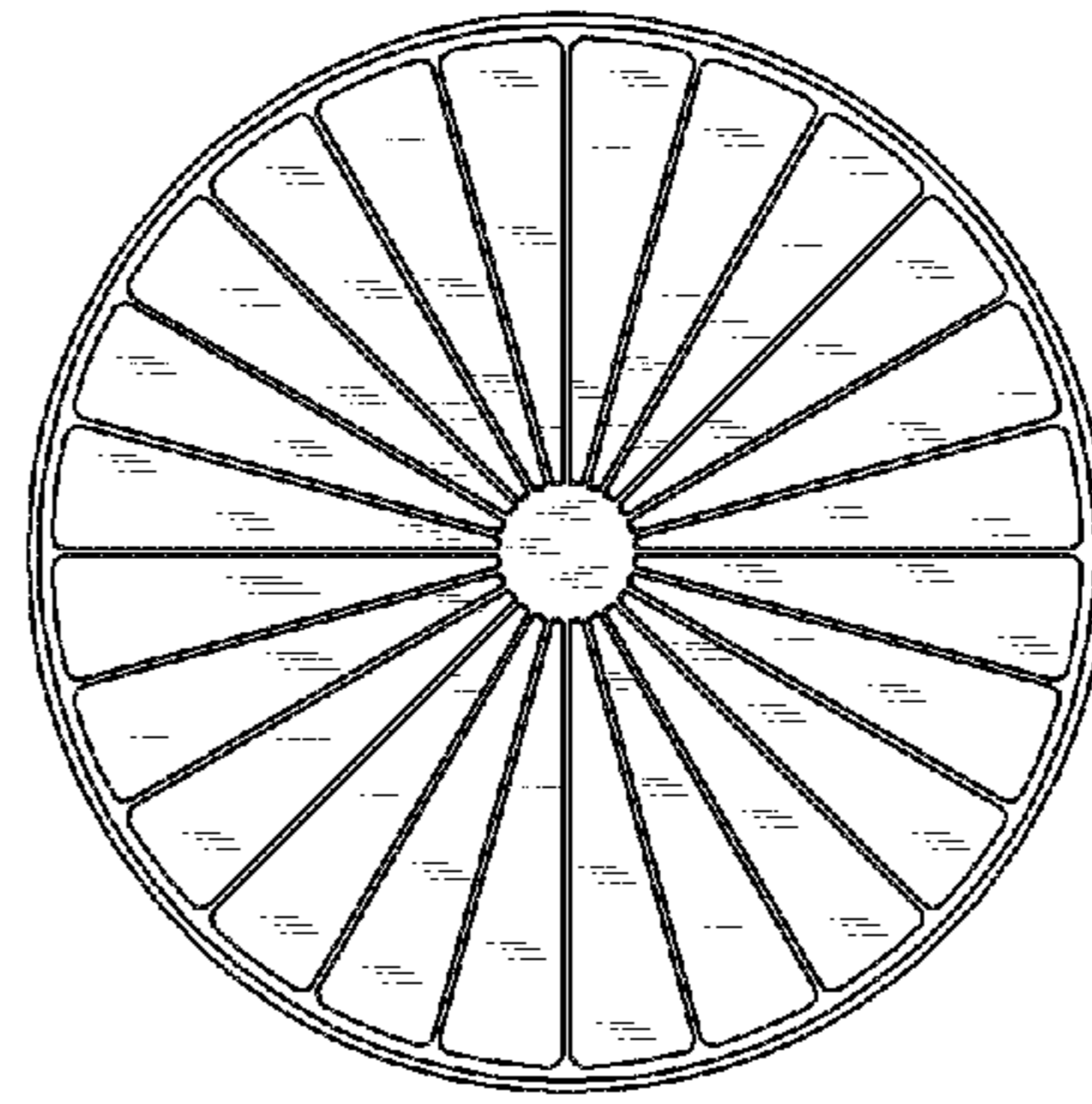

FIG.13

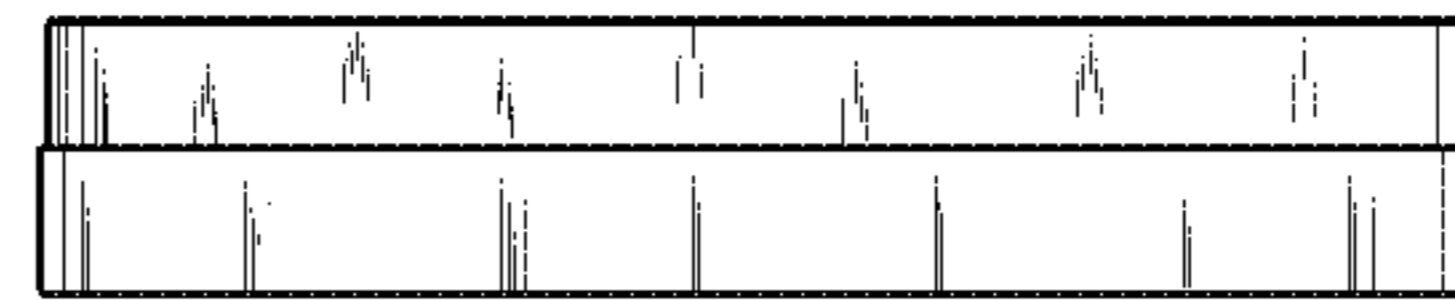

FIG.15

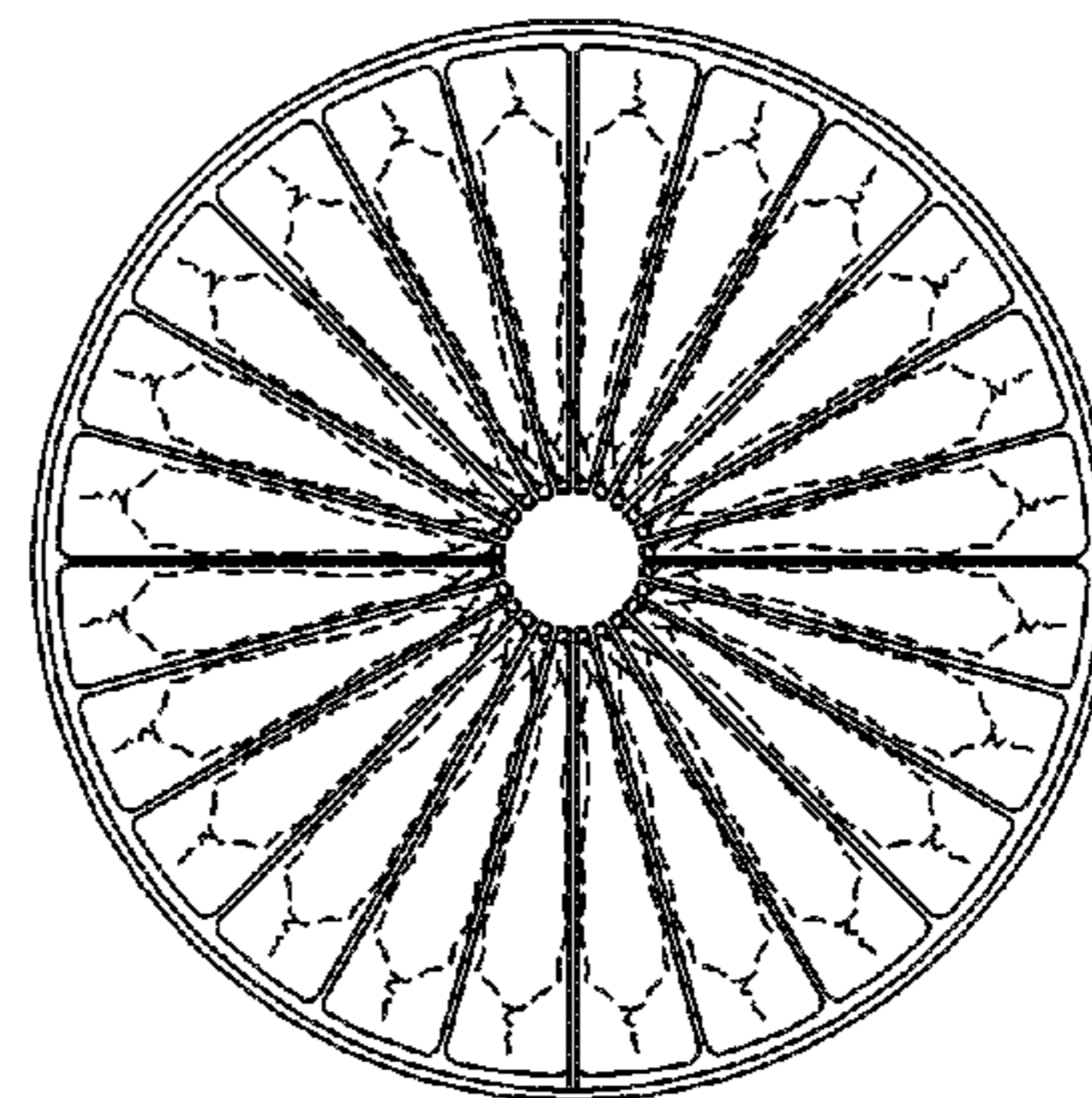
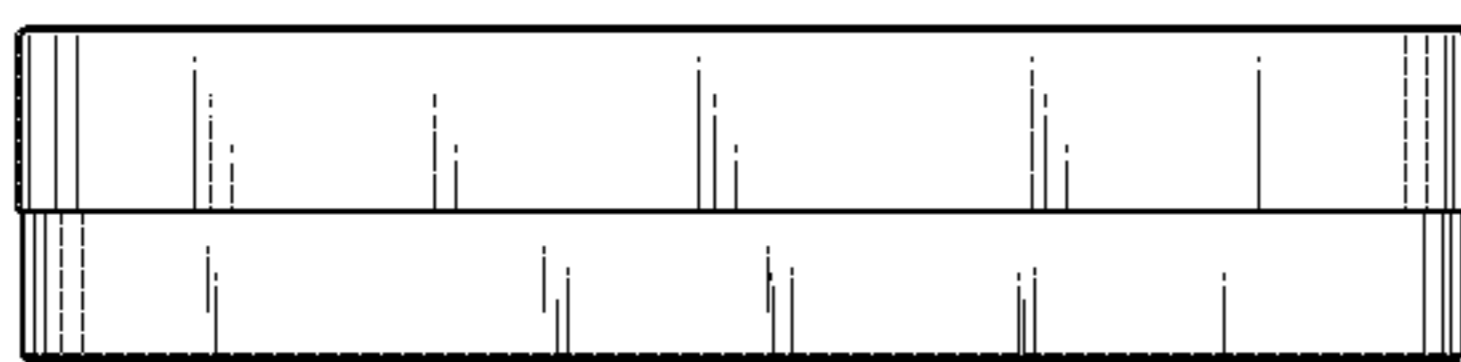

FIG.14





US00D683497C1

(12) **EX PARTE REEXAMINATION CERTIFICATE** (10378th)
United States Patent
Ghiotti et al.

(10) **Number:** **US D683,497 C1**
(45) **Certificate Issued:** **Oct. 31, 2014**

(54) **CONTAINER FOR POUCHES OF SMOKELESS TOBACCO**

(75) Inventors: **Roberto Ghiotti**, Calderino di Monte San Pietro (IT); **Fulvio Boldrini**, Ferrara (IT)

(73) Assignee: **Azionaria Costruzioni Macchine Automatiche A.C.M.A. S.p.A.**, Bologna (IT)

Reexamination Request:
No. 90/013,128, Jan. 22, 2014

Reexamination Certificate for:
Patent No.: **Des. 683,497**
Issued: **May 28, 2013**
Appl. No.: **29/388,818**
Filed: **Apr. 1, 2011**

Related U.S. Application Data

(62) Division of application No. 29/365,192, filed on Jul. 6, 2010, now Pat. No. Des. 637,903.

(30) **Foreign Application Priority Data**

Jan. 21, 2010 (IT) BO201000001

(51) **LOC (10) Cl.** **09-03**

(52) **U.S. Cl.**
USPC **D9/428**

(58) **Field of Classification Search**
USPC D9/504, 428, 737, 738, 756, 772;
D27/172, 183, 186, 189, 190; 422/5;
131/329; 206/533, 538, 525; 220/23,
220/83

See application file for complete search history.

(56) **References Cited**

To view the complete listing of prior art documents cited during the proceeding for Reexamination Control Number 90/013,128, please refer to the USPTO's public Patent Application Information Retrieval (PAIR) system under the Display References tab.

Primary Examiner — Phillip S Hyder

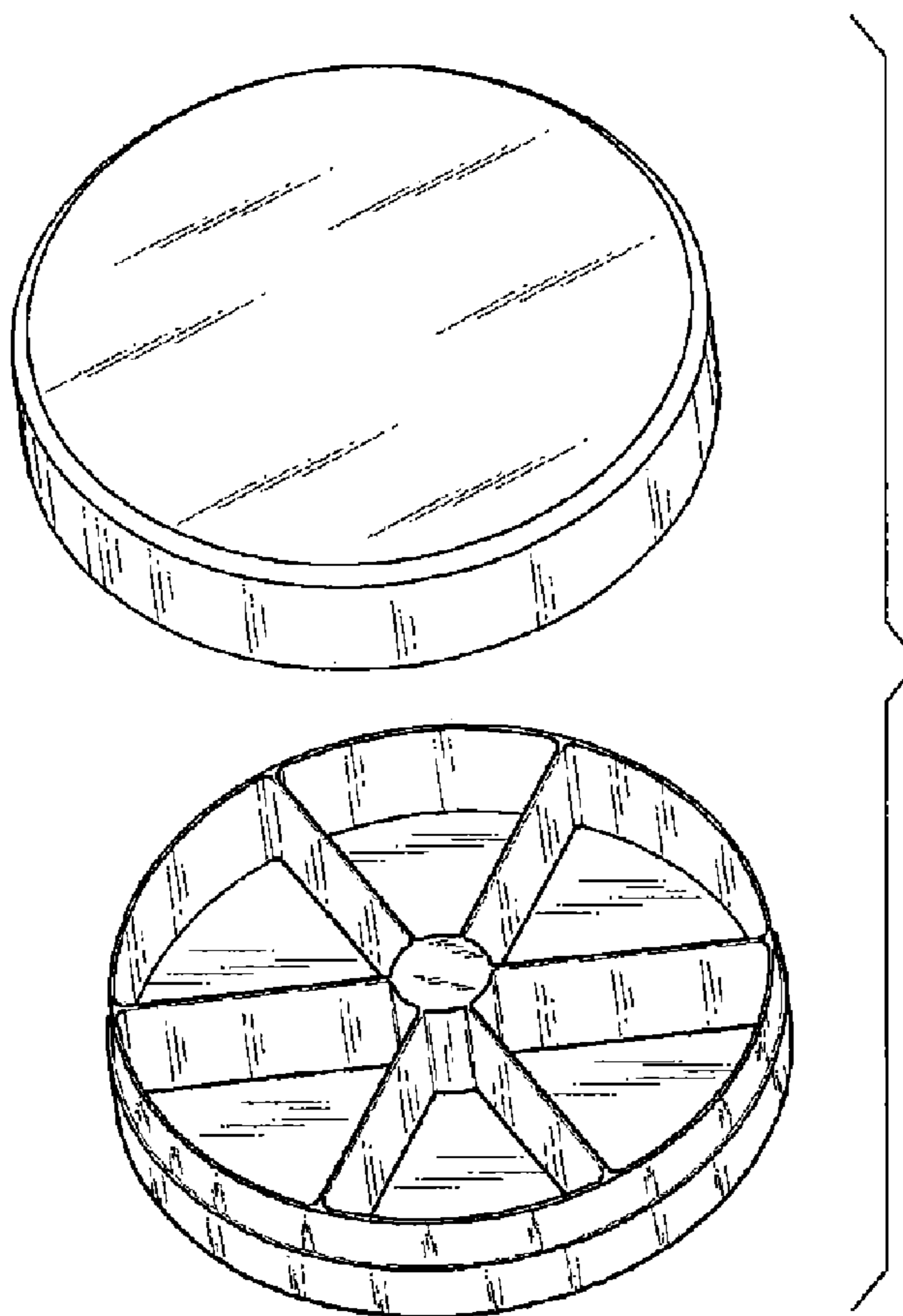

1

2

**EX PARTE
REEXAMINATION CERTIFICATE
ISSUED UNDER 35 U.S.C. 307**

5

NO AMENDMENTS HAVE BEEN MADE TO
THE PATENT

AS A RESULT OF REEXAMINATION, IT HAS BEEN
DETERMINED THAT:

10

The patentability of 1 is confirmed.

* * * * *