



US00D683454S

(12) **United States Design Patent**
Malmen

(10) **Patent No.:** **US D683,454 S**

(45) **Date of Patent:** **** May 28, 2013**

(54) **DENTAL X-RAY MACHINE**

(75) Inventor: **Kari Malmen**, Helsinki (FI)

(73) Assignee: **Planmeca Oy**, Helsinki (FI)

(**) Term: **14 Years**

(21) Appl. No.: **29/368,445**

(22) Filed: **Aug. 24, 2010**

Related U.S. Application Data

(63) Continuation-in-part of application No. 29/536,723, filed on Mar. 2, 2010, now abandoned, which is a continuation of application No. 29/299,103, filed on Dec. 19, 2007, now abandoned.

(51) **LOC (9) Cl.** **24-01**

(52) **U.S. Cl.**
USPC **D24/158**

(58) **Field of Classification Search**
USPC D24/158-161, 185, 186, 177, 178; 378/4, 378/15, 17, 20, 21, 23-27, 62, 68, 146, 37, 378/195-198, 177, 179, 208, 38, 39, 40; D15/199; 248/276.1, 278.1
See application file for complete search history.

(56) **References Cited**

U.S. PATENT DOCUMENTS

D272,385 S * 1/1984 Nakano et al. D24/158
6,118,842 A * 9/2000 Arai et al. 378/39

6,169,780 B1 * 1/2001 Yoshimura et al. 378/39
6,584,171 B2 * 6/2003 Suzuki et al. 378/39
D477,407 S * 7/2003 Malmen D24/158
D502,543 S * 3/2005 Phleps et al. D24/158
D571,471 S * 6/2008 Stockl D24/158
7,424,091 B2 * 9/2008 Park et al. 378/39
7,469,032 B2 * 12/2008 Walker et al. 378/38
2006/0227938 A1 * 10/2006 Walker et al. 378/195

FOREIGN PATENT DOCUMENTS

EM 000787346-0001 * 10/2007

* cited by examiner

Primary Examiner — Anhdao Doan

(74) *Attorney, Agent, or Firm* — Cozen O'Connor

(57) **CLAIM**

I claim the ornamental design for a dental x-ray machine, as shown and described.

DESCRIPTION

FIG. 1 shows a left side perspective view of a dental x-ray machine of my new design;

FIG. 2 shows a front view thereof;

FIG. 3 shows a rear view thereof;

FIG. 4 shows a right side view thereof;

FIG. 5 shows a left side view thereof;

FIG. 6 shows a top view thereof; and,

FIG. 7 shows a bottom view thereof.

The broken lines in the drawings are included for the purpose of illustrating a portion of the dental x-ray machine that forms no part of the claimed design.

1 Claim, 7 Drawing Sheets

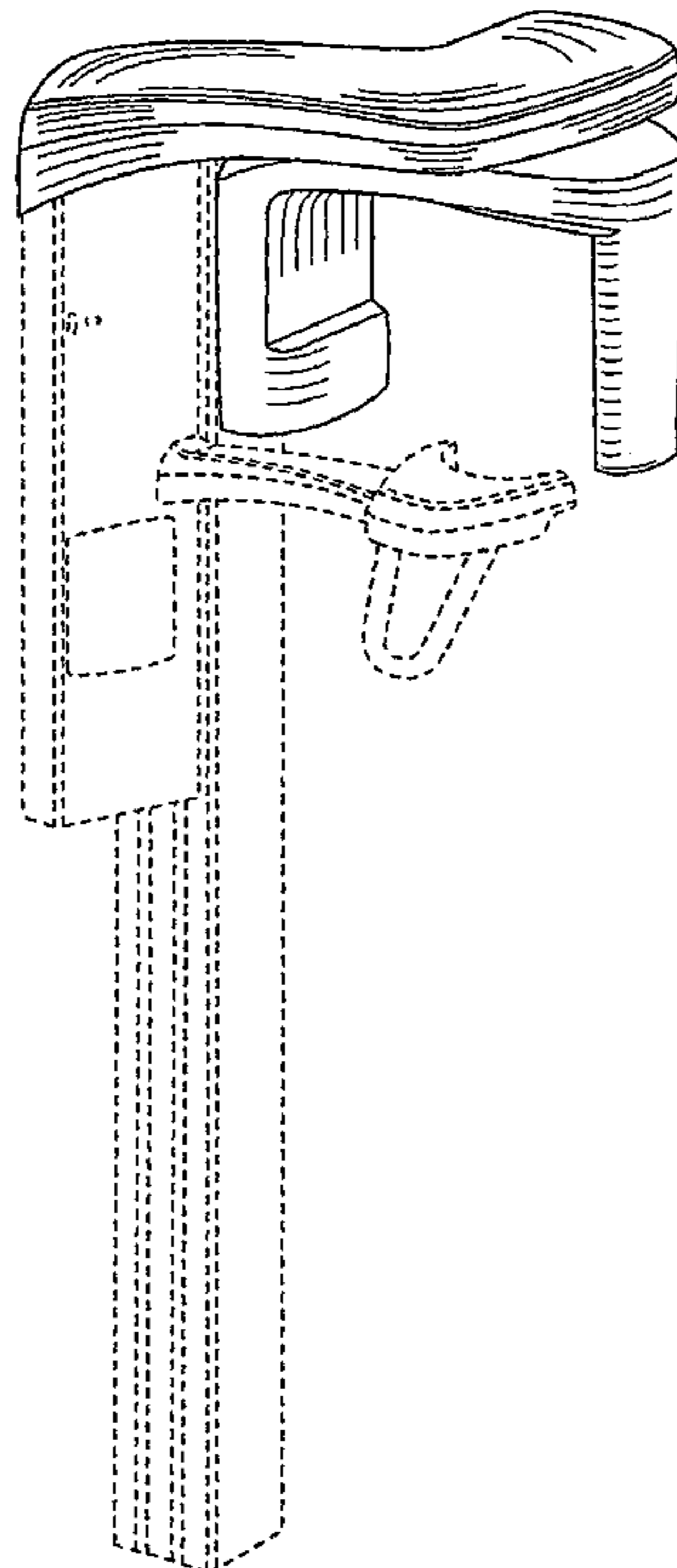

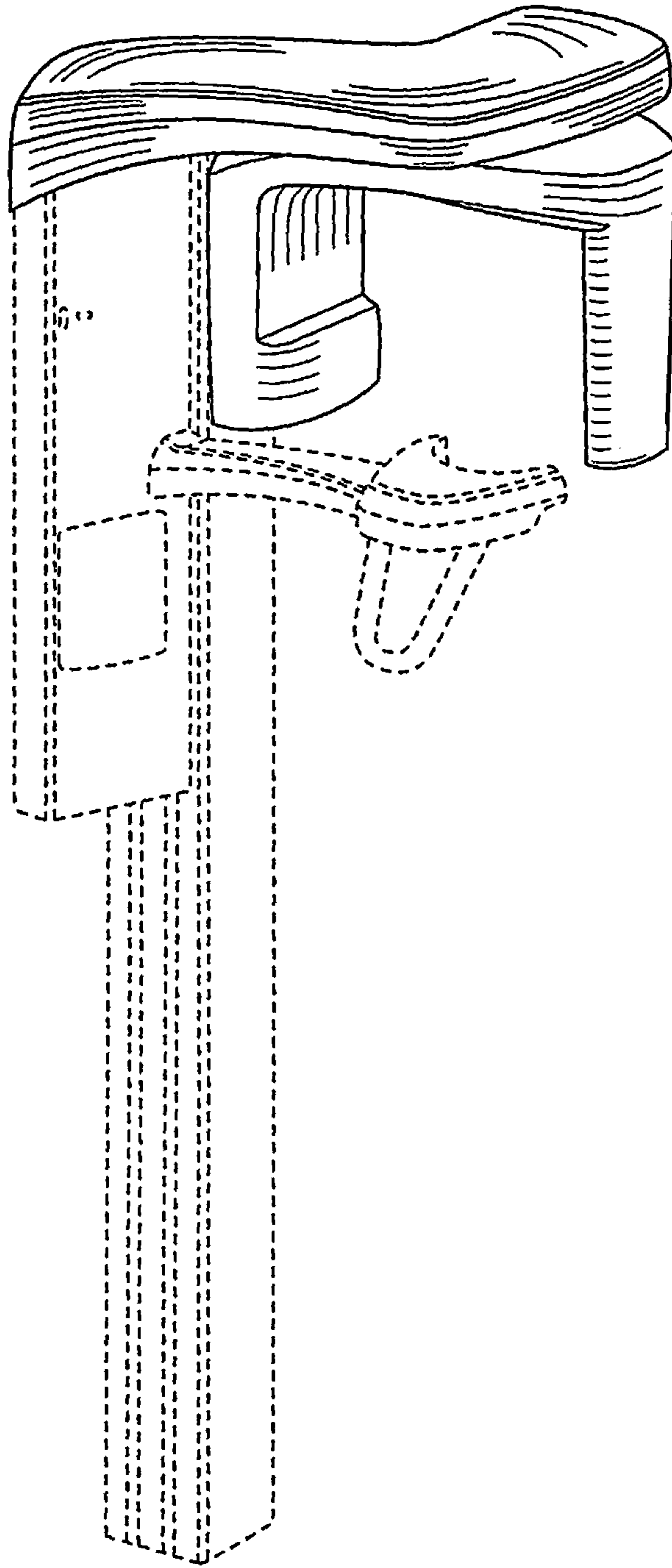

FIG. 1

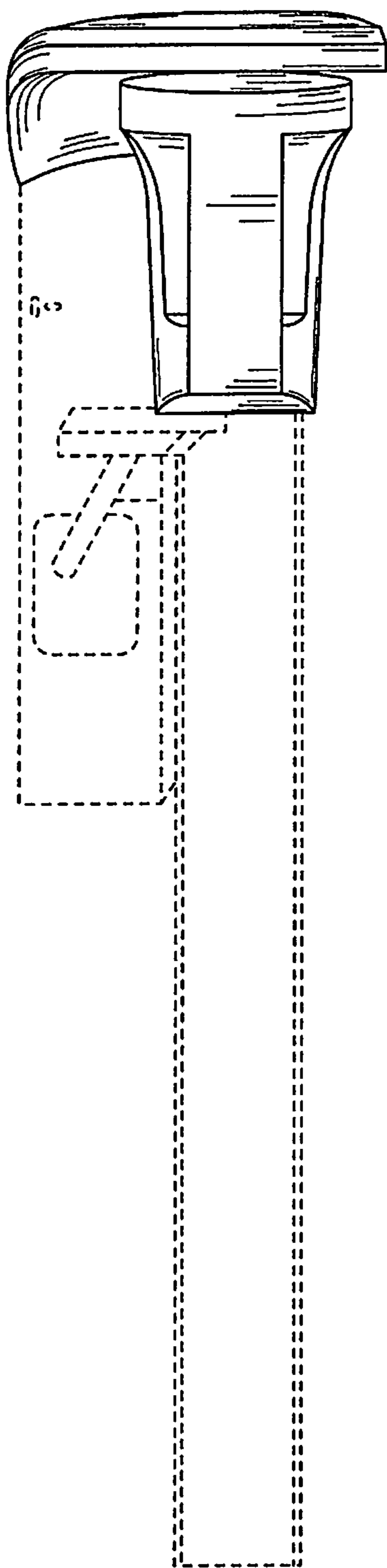

FIG. 2

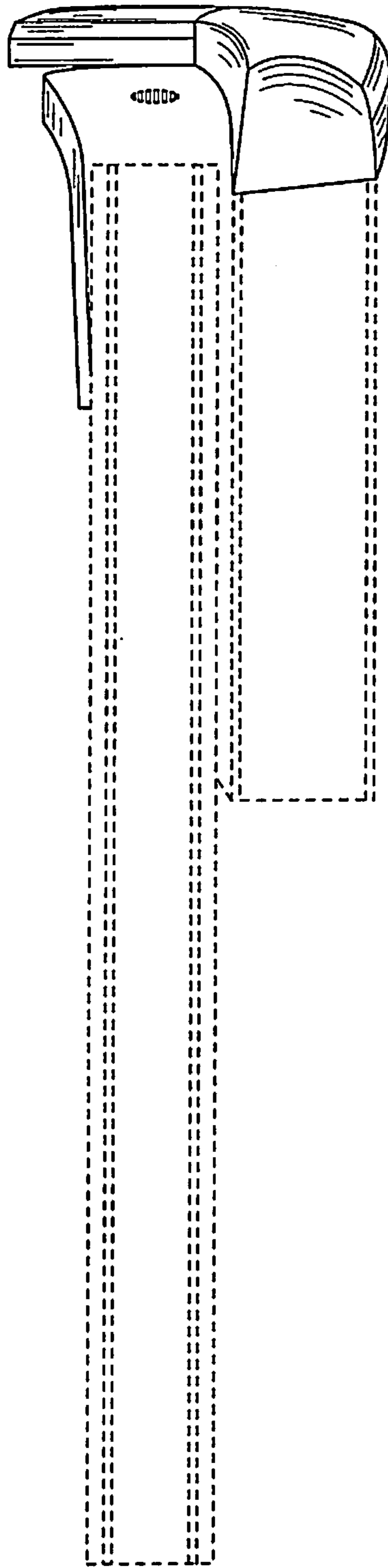

FIG. 3

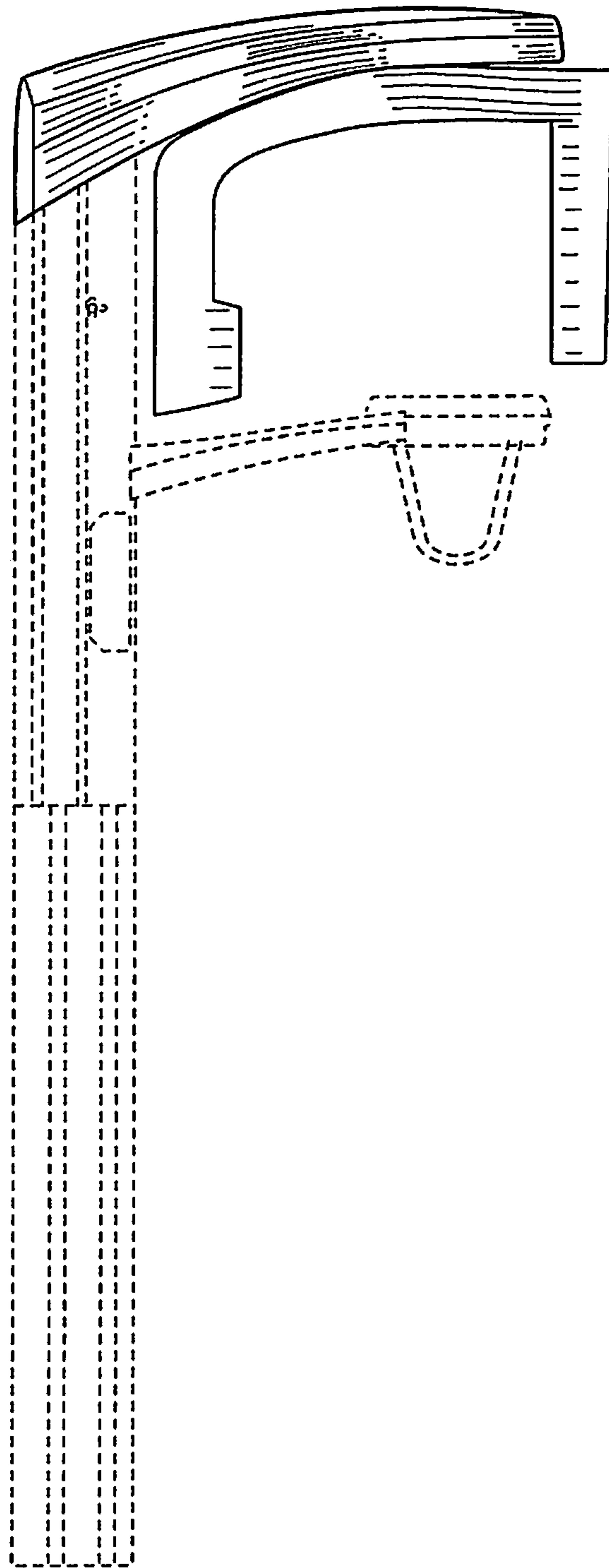

FIG. 4

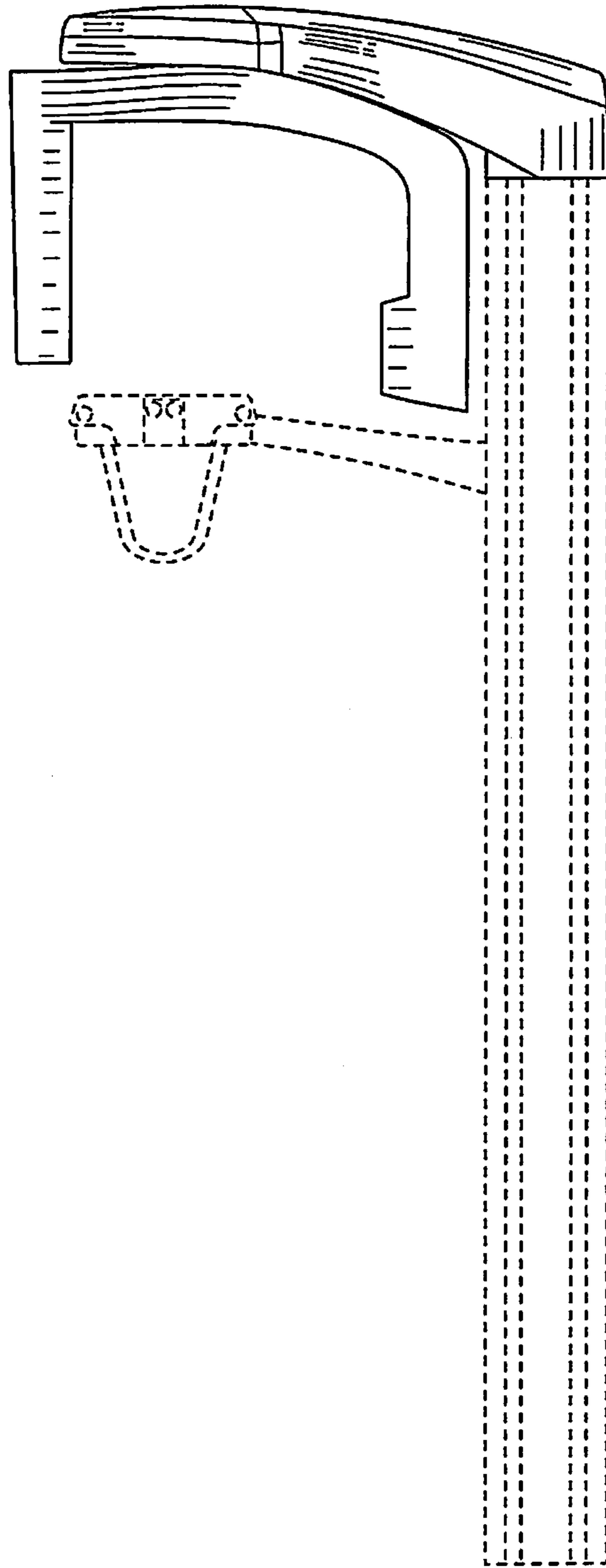

FIG. 5

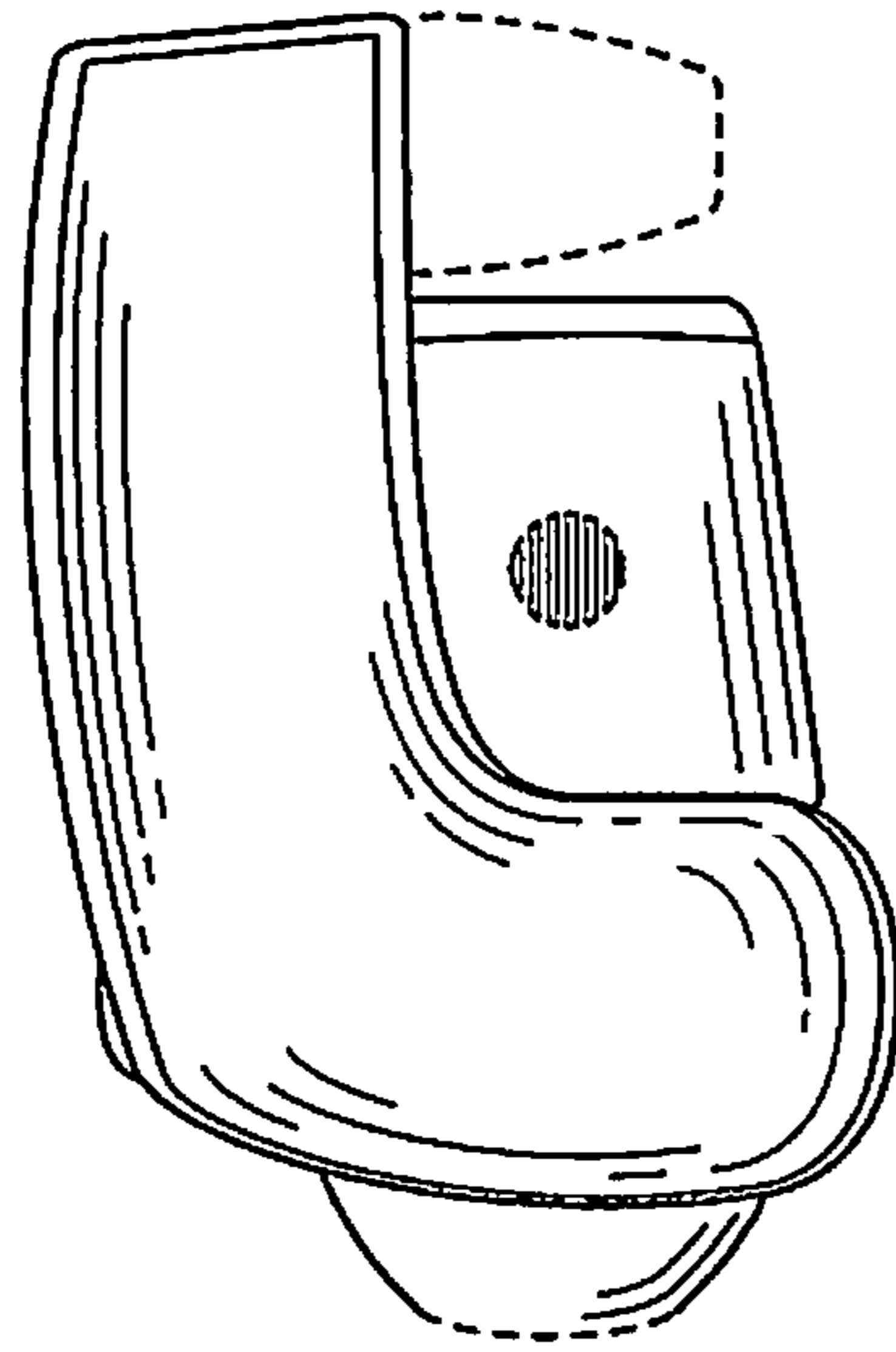

FIG. 6

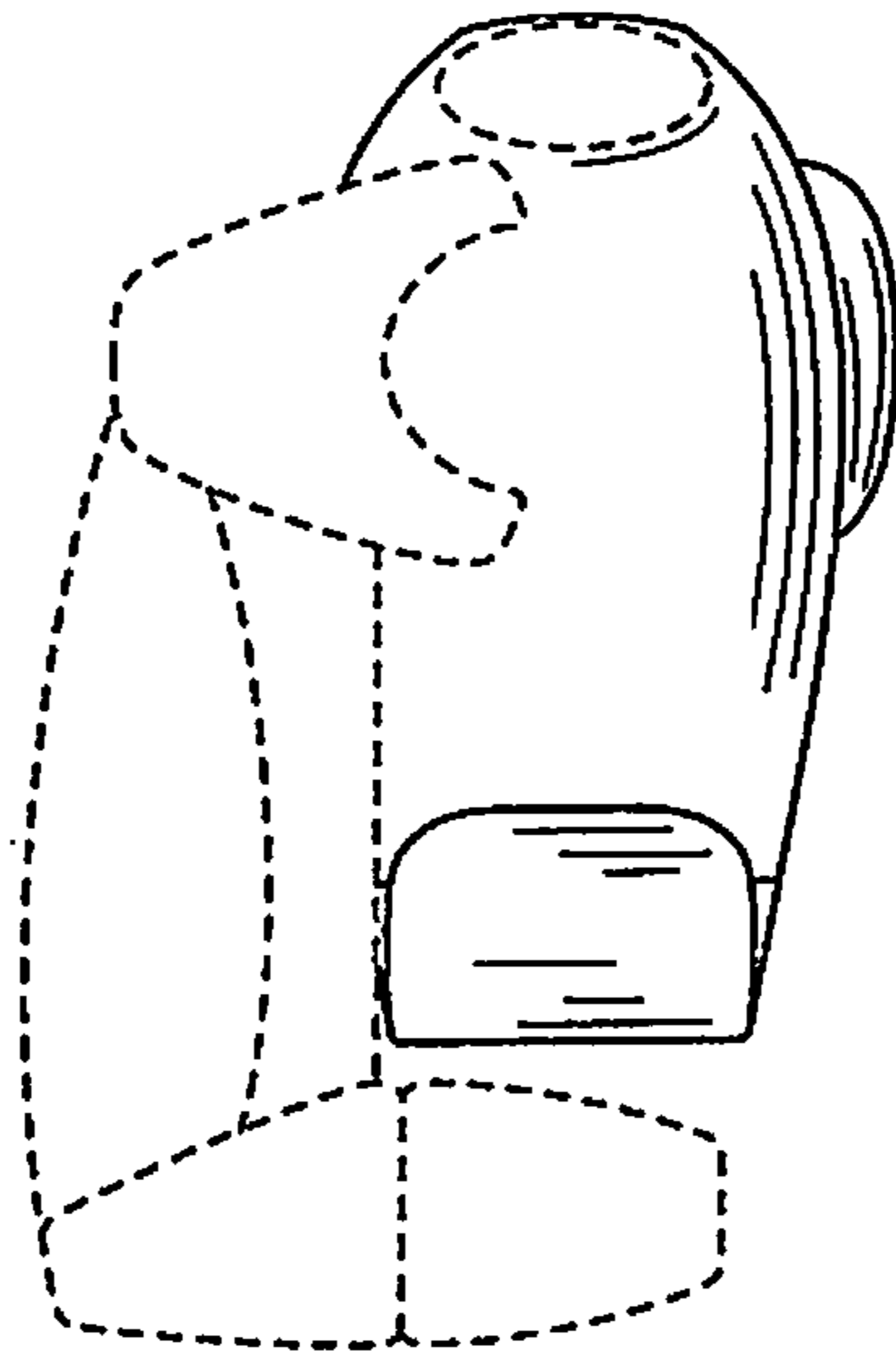

FIG. 7