

US00D683446S

(12) **United States Design Patent**
Eves et al.

(10) **Patent No.:** **US D683,446 S**
(45) **Date of Patent:** **** May 28, 2013**

(54) **CUSHION FOR RESPIRATORY MASK**

(75) Inventors: **Matthew Eves**, Manly Vale (AU); **Adam Barlow**, Lilyfield (AU); **Lochlan von Moger**, Bella Vista (AU)

(73) Assignee: **ResMed Limited**, Bella Vista (AU)

(**) **Term:** **14 Years**

(21) Appl. No.: **29/380,213**

(22) Filed: **Dec. 1, 2010**

(51) **LOC (9) Cl.** **29-02**

(52) **U.S. Cl.**
USPC **D24/110.4**

(58) **Field of Classification Search**
USPC D24/110-110.4; 128/206.24, 206.25,
128/206.26, 207.11, 205.25, 206.21, 206.28,
128/207.13

See application file for complete search history.

(56) **References Cited**

U.S. PATENT DOCUMENTS

5,429,683	A	7/1995	Mitouard	
D397,215	S *	8/1998	Hoftman	D24/110.4
D431,077	S *	9/2000	McGinnis et al.	D24/110.4
D499,803	S *	12/2004	Chang	D24/110.4
D556,898	S *	12/2007	Guney et al.	D24/110.1
D557,408	S *	12/2007	Amarasinghe et al.	D24/110.1
D585,981	S *	2/2009	Moore et al.	D24/110.1
7,523,754	B2 *	4/2009	Lithgow et al.	128/206.24
7,546,837	B2 *	6/2009	Busch et al.	128/206.24
2004/0221850	A1	11/2004	Ging et al.	
2005/0028822	A1	2/2005	Sleeper et al.	
2008/0047560	A1	2/2008	Veliss et al.	
2008/0121235	A1	5/2008	Ging et al.	
2009/0095301	A1 *	4/2009	Hitchcock et al.	128/206.21

FOREIGN PATENT DOCUMENTS

EP	0747078	B1	10/2002
EP	0998319	B1	11/2004
EP	1057494	B1	11/2004
WO	WO 2008/011682	A1	1/2008
WO	2010/139014	A1	12/2010

OTHER PUBLICATIONS

Written Opinion of the International Searching Authority and International Search Report for PCT/AU2010/000684, mailed Sep. 15, 2010, 20 pages.

Australian Patent Examination Report No. 1 for AU 2010256351, issued Aug. 28, 2012, 5 pages.

New Zealand Examination Report for NZ 596486, issued Oct. 5, 2012, 2 pages.

* cited by examiner

Primary Examiner — Ian Simmons

Assistant Examiner — Richelle Shelton

(74) *Attorney, Agent, or Firm* — Nixon & Vanderhye, P.C.

(57) **CLAIM**

The ornamental design for a cushion for a respiratory mask, as shown and described.

DESCRIPTION

FIG. 1 is a front perspective view of a cushion for a respiratory mask according to our new ornamental design;

FIG. 2 is a front view thereof;

FIG. 3 is a rear view thereof;

FIG. 4 is a top view thereof;

FIG. 5 is a bottom view thereof;

FIG. 6 is a right side view thereof, with the left side view thereof being a mirror image thereof; and,

FIG. 7 is a rear perspective view thereof.

The broken lines represent environmental structure and do not form a part of the claimed design.

1 Claim, 4 Drawing Sheets

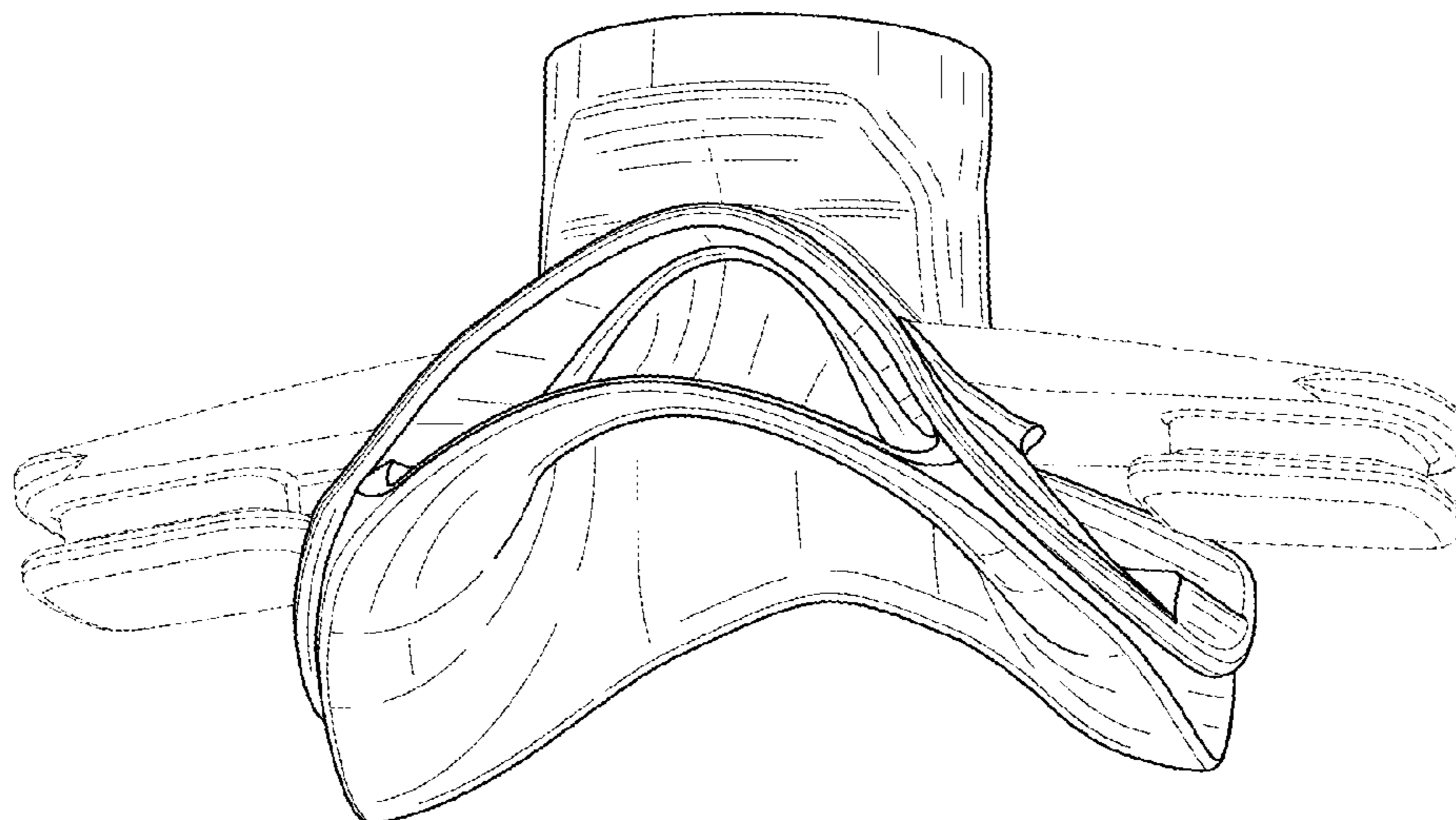

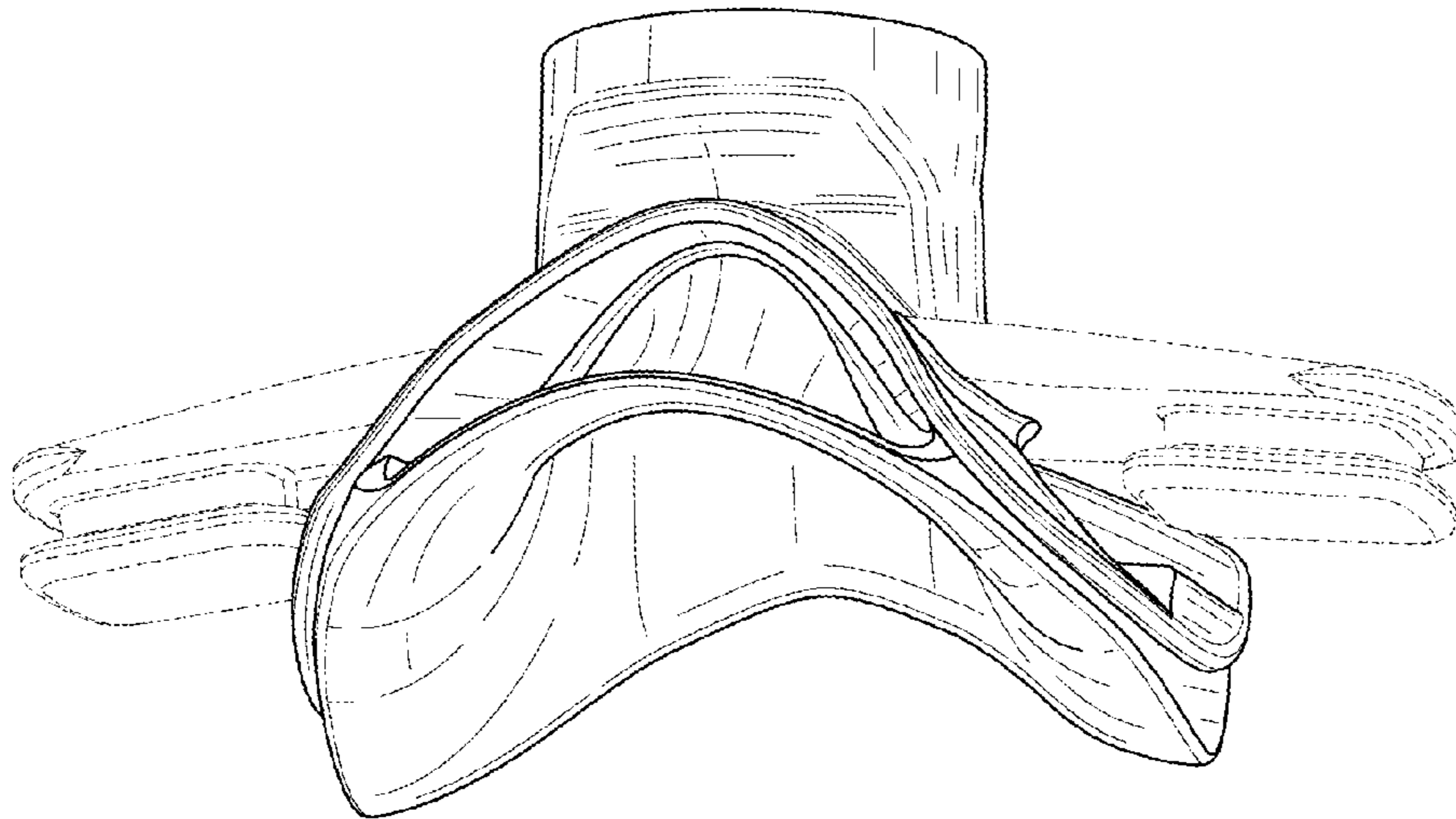

FIG. 1

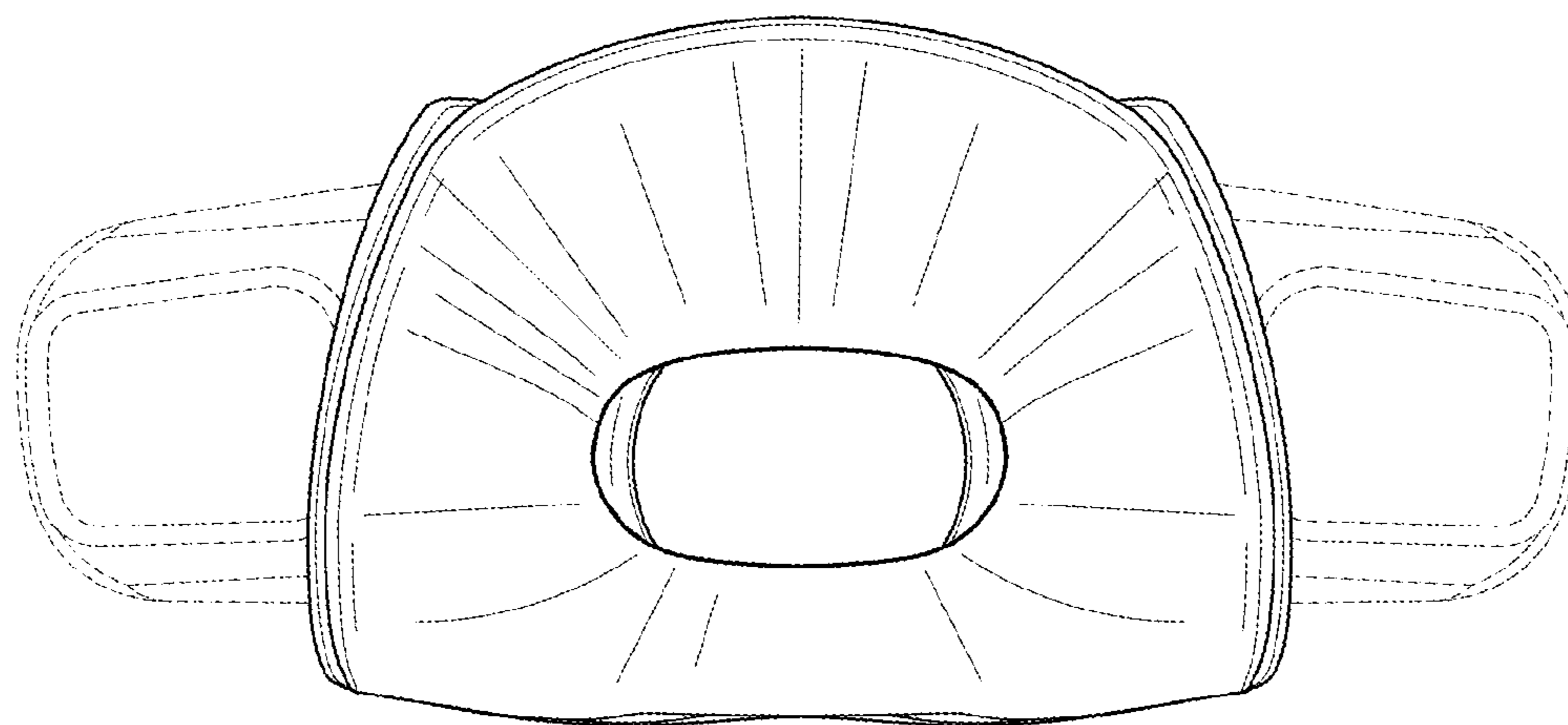

FIG. 2

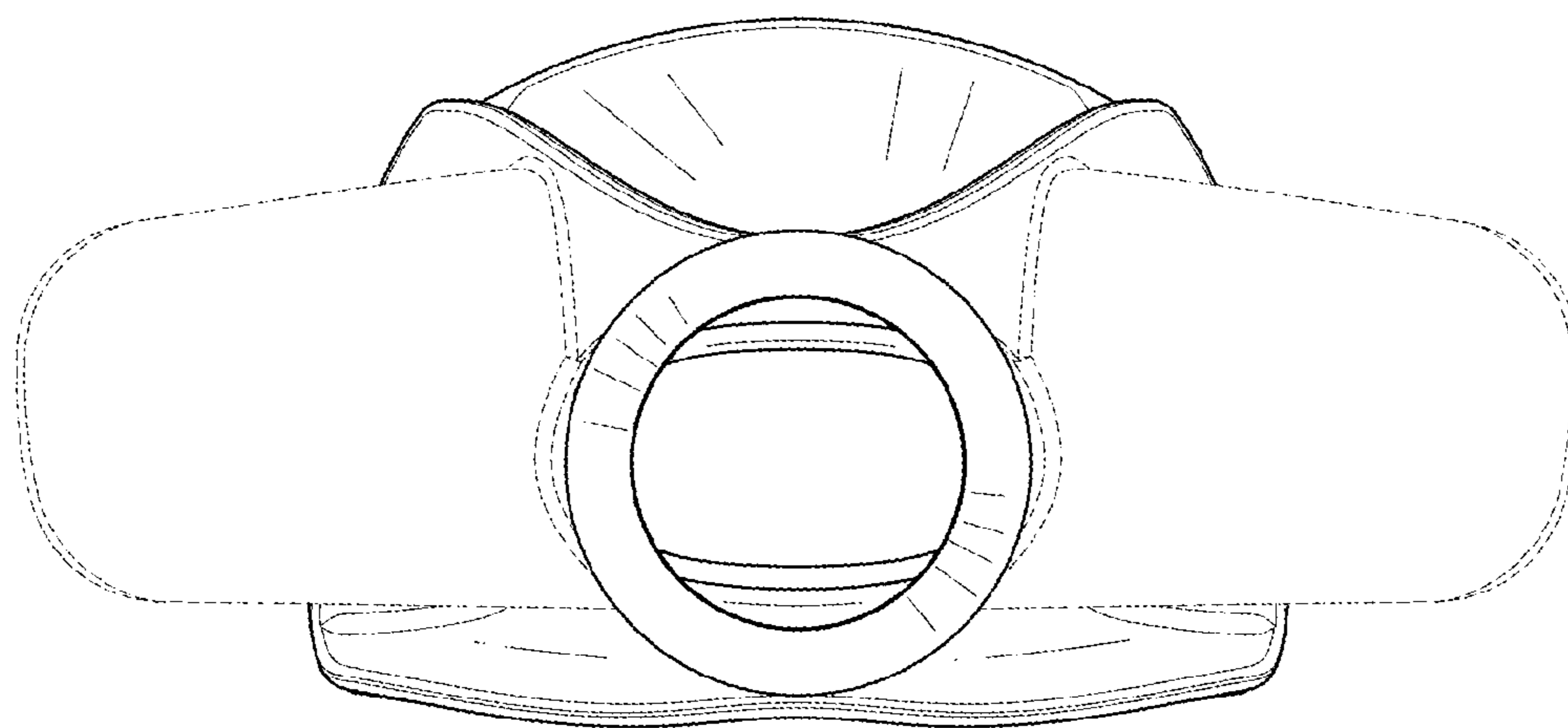

FIG. 3

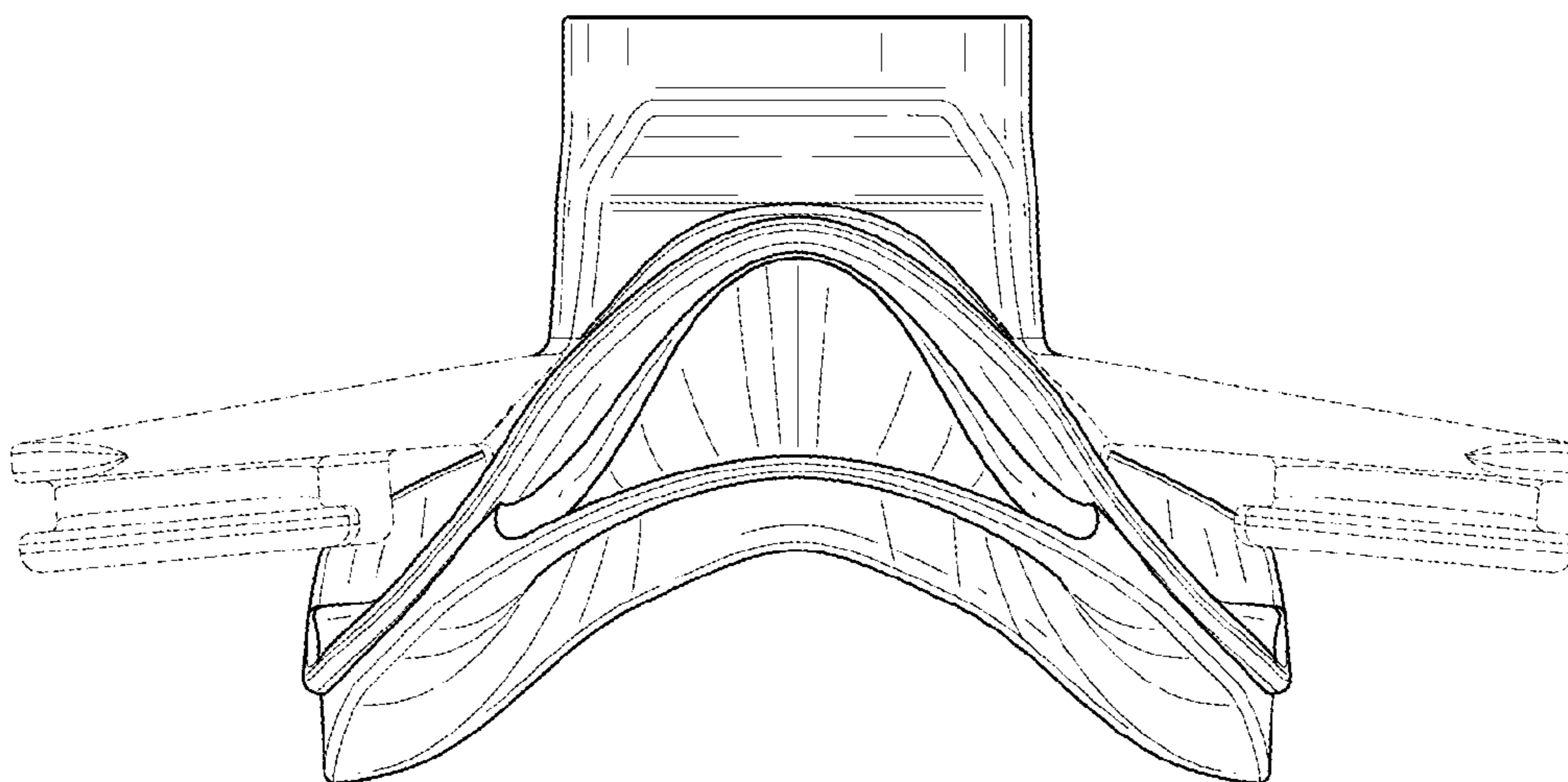

FIG. 4

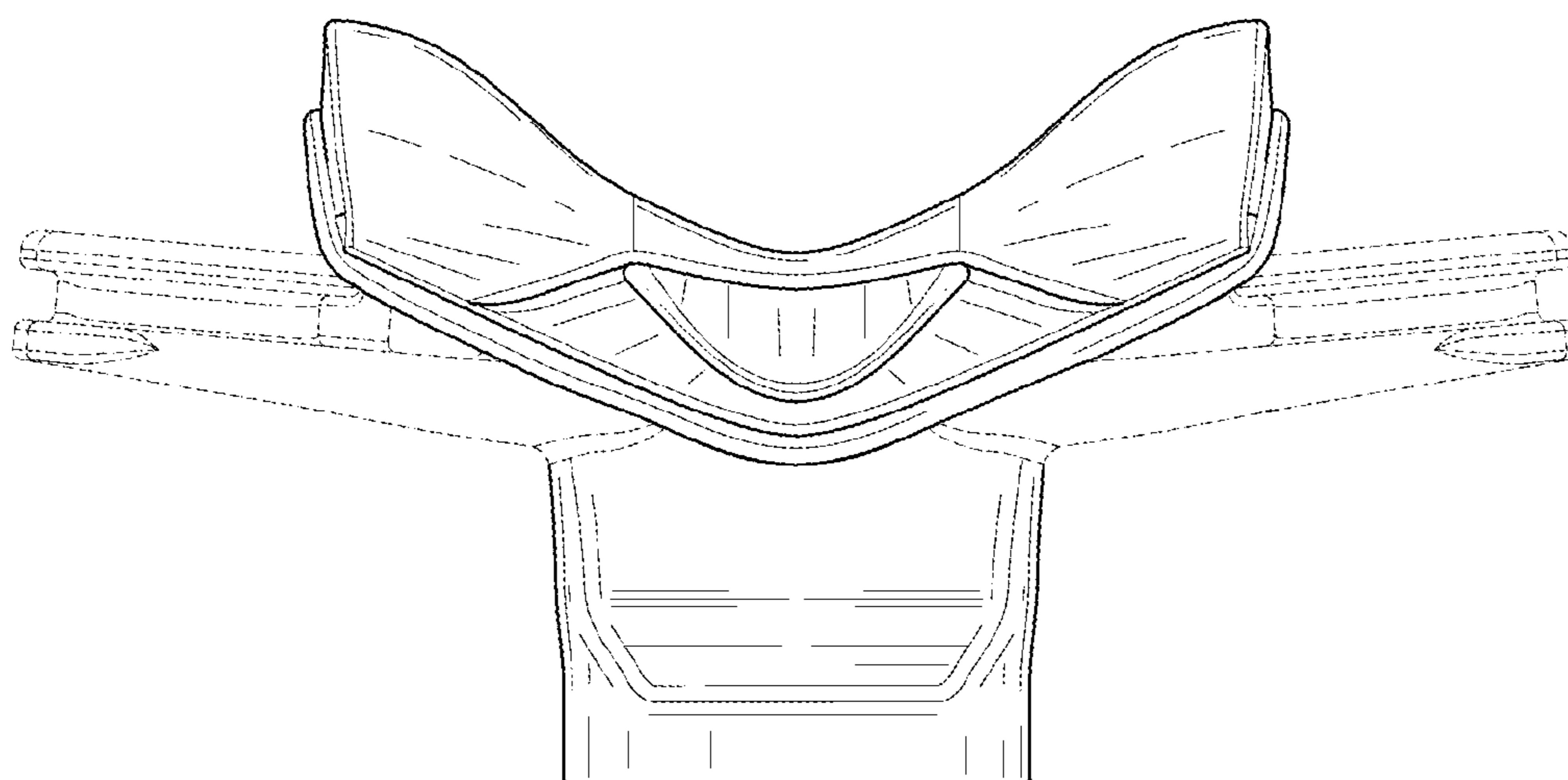

FIG. 5

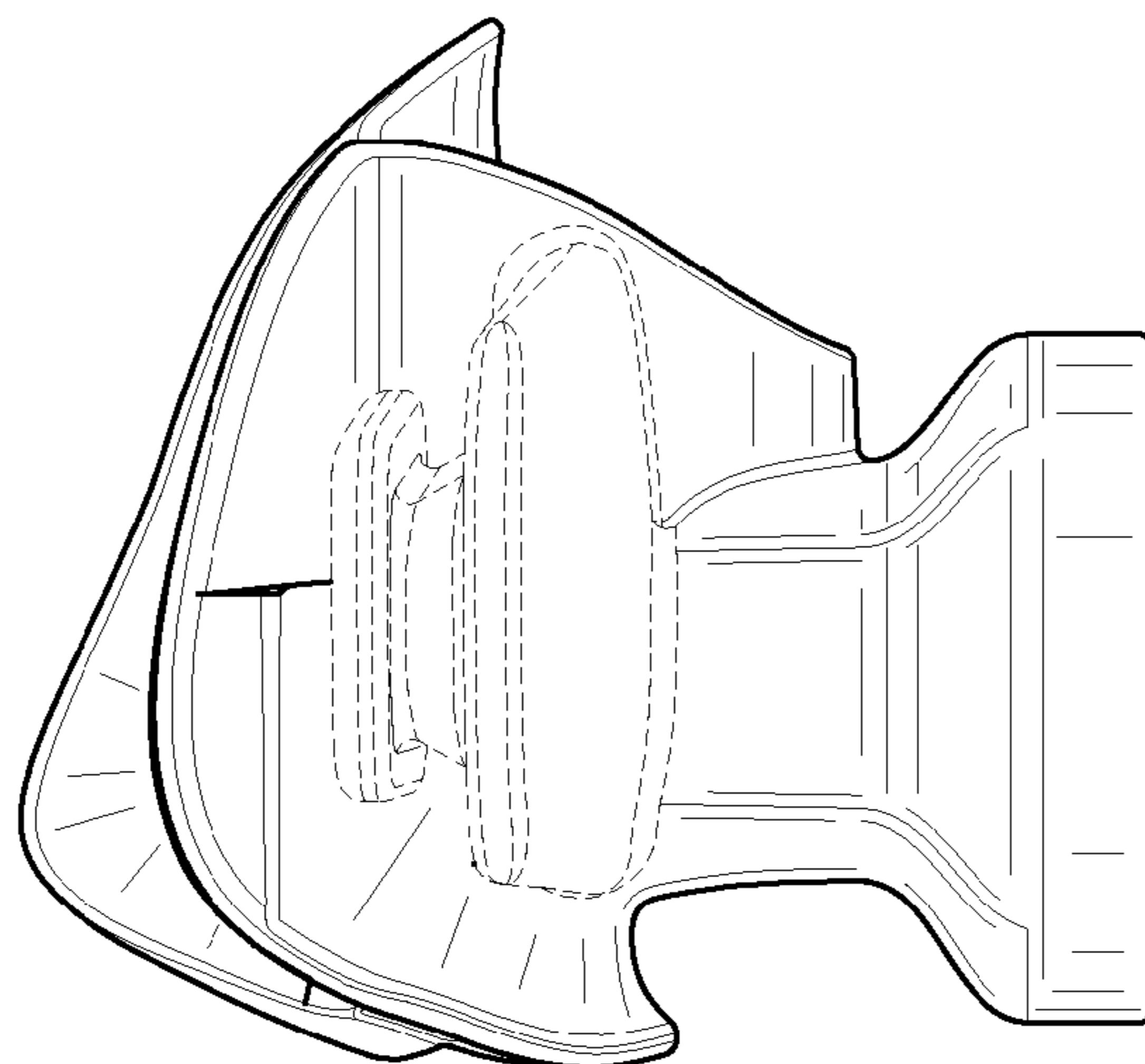

FIG. 6

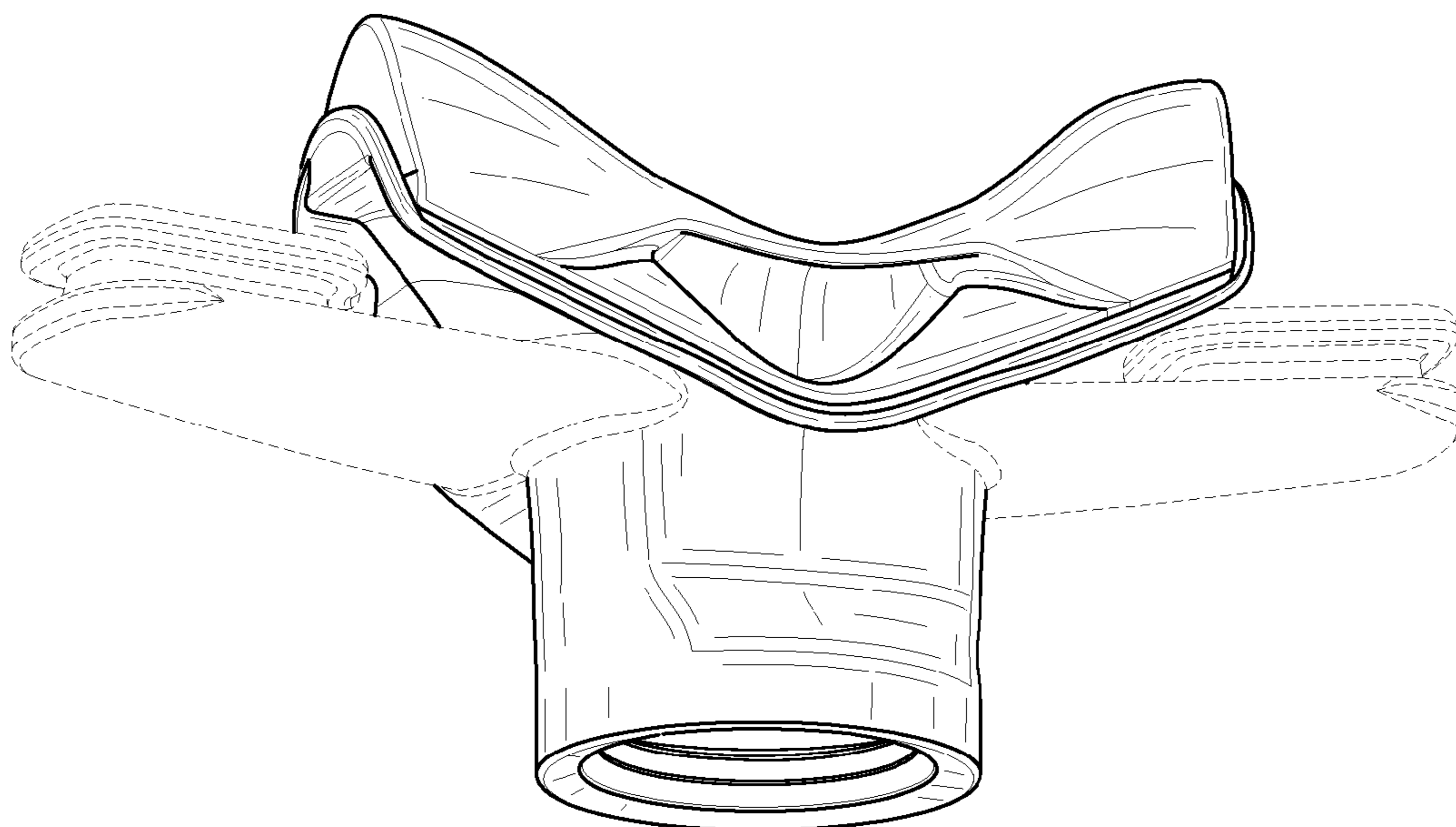

FIG. 7