



US00D683402S

(12) **United States Design Patent**
Xie

(10) **Patent No.:** **US D683,402 S**

(45) **Date of Patent:** **** May 28, 2013**

(54) **PEN**

(75) **Inventor:** **Jianzhe Xie**, Ningbo (CN)

(73) **Assignee:** **Beifa Group Co., Ltd.**, Ningbo (CN)

(**) **Term:** **14 Years**

(21) **Appl. No.:** **29/405,859**

(22) **Filed:** **Nov. 7, 2011**

(30) **Foreign Application Priority Data**

May 5, 2011 (CN) 2011 3 0104568

(51) **LOC (9) Cl.** **19-06**

(52) **U.S. Cl.**
USPC **D19/49**

(58) **Field of Classification Search**
USPC .. D14/411; D19/35, 36, 41-51, 54-58; 24/11
F, 11 P, 11 R; 401/52, 99-109, 192, 195,
401/196; D28/7, 76, 88

See application file for complete search history.

(56) **References Cited**

U.S. PATENT DOCUMENTS

D363,308 S * 10/1995 Sekine D19/48
D385,916 S * 11/1997 Katami D19/48

D484,536 S * 12/2003 Takanashi D19/43
D499,137 S * 11/2004 Shibata D19/43
D540,383 S * 4/2007 Nishida D19/43
D567,853 S 4/2008 Qiu
D572,761 S * 7/2008 Zhang D19/50
D641,788 S * 7/2011 Rolion et al. D19/50
D672,808 S * 12/2012 Liang et al. D19/43
D672,809 S * 12/2012 Jiang et al. D19/43
D673,216 S * 12/2012 Yuan D19/50

* cited by examiner

Primary Examiner — Elizabeth Albert

(74) *Attorney, Agent, or Firm* — Christensen O'Connor Johnson Kindness PLLC

(57) **CLAIM**

The ornamental design for a pen, as shown and described.

DESCRIPTION

FIG. 1 is a lower front right perspective view of a pen showing my new design;

FIG. 2 is a front elevation view thereof;

FIG. 3 is a rear elevation view thereof;

FIG. 4 is a right side elevation view thereof, with the left side elevation view being a mirror image of the right side elevation view;

FIG. 5 is an enlarged top plan view thereof; and,

FIG. 6 is an enlarged bottom plan view thereof.

1 Claim, 4 Drawing Sheets

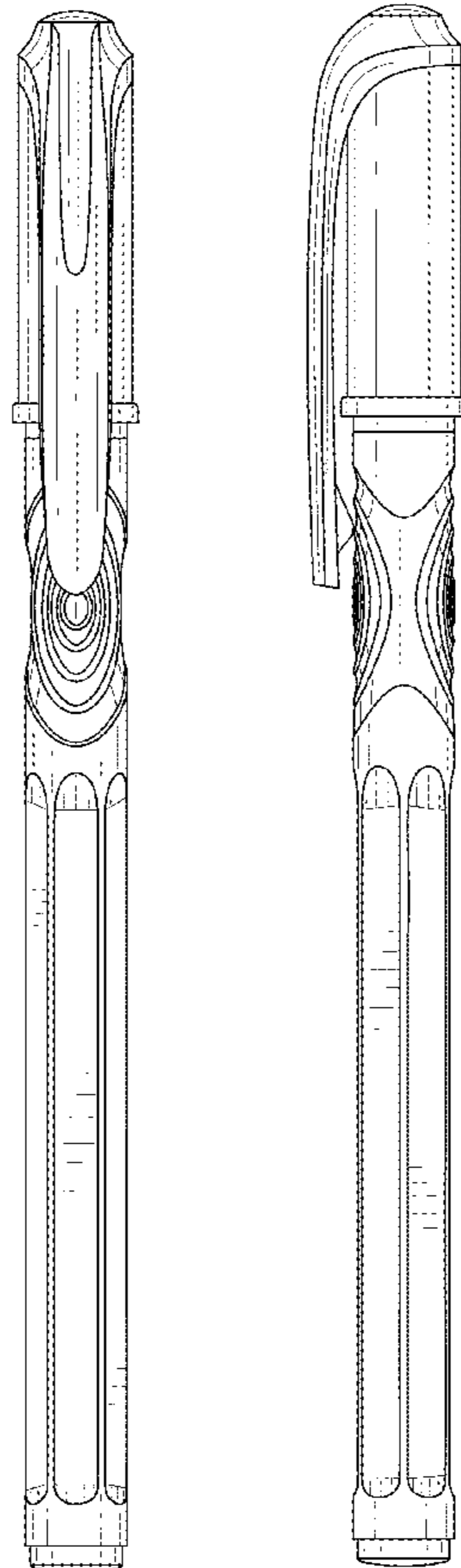

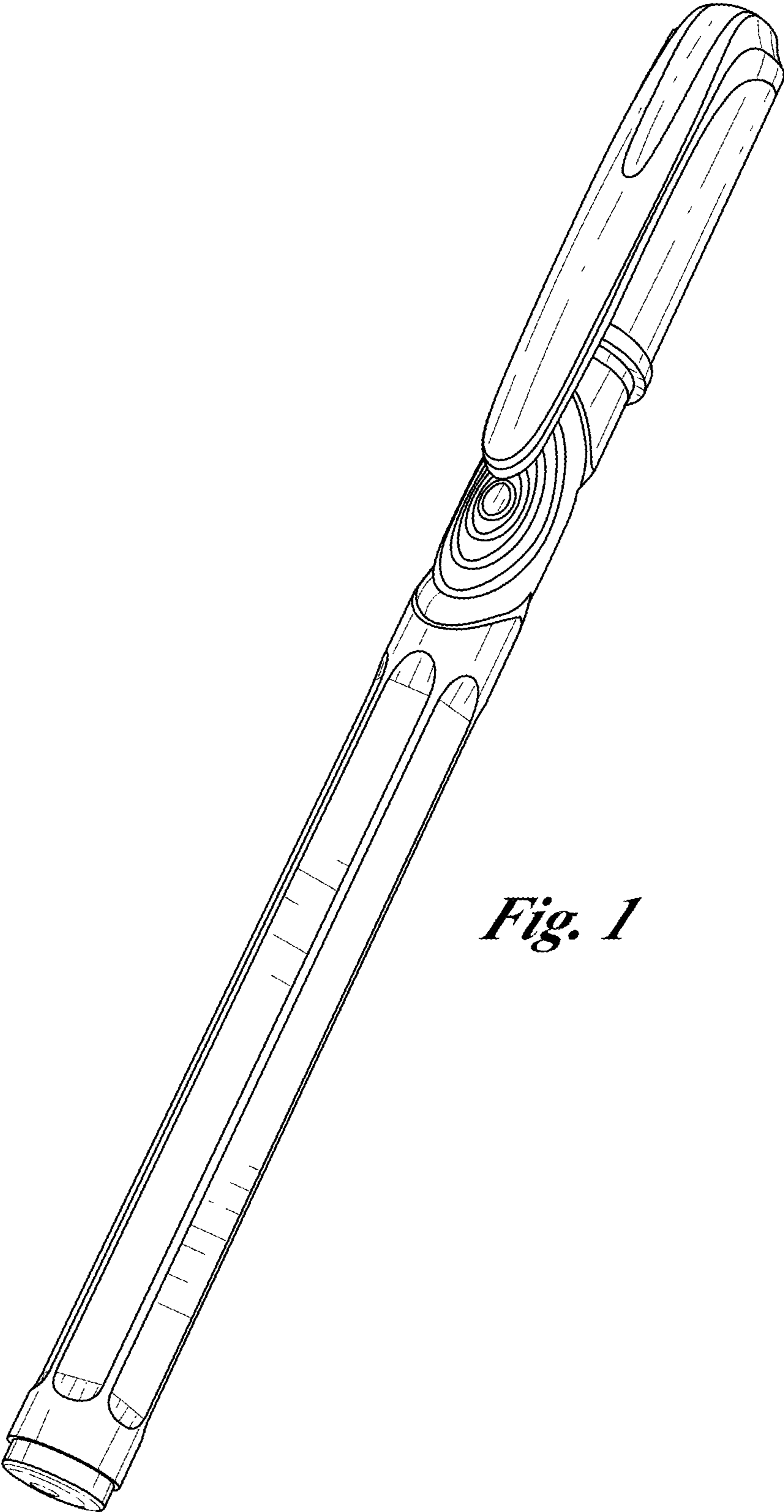

Fig. 1

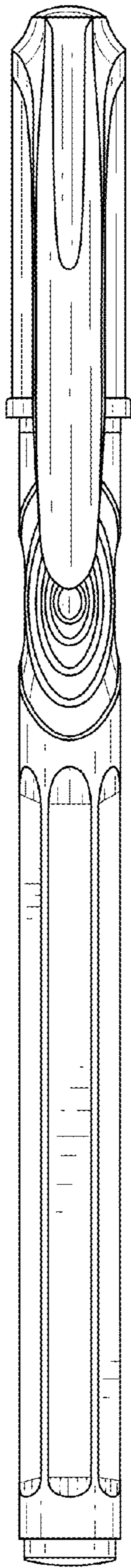

Fig. 2

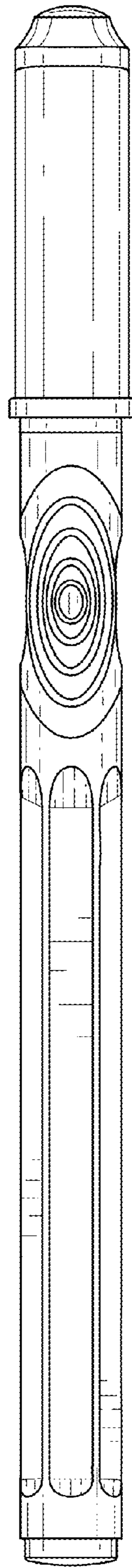

Fig. 3

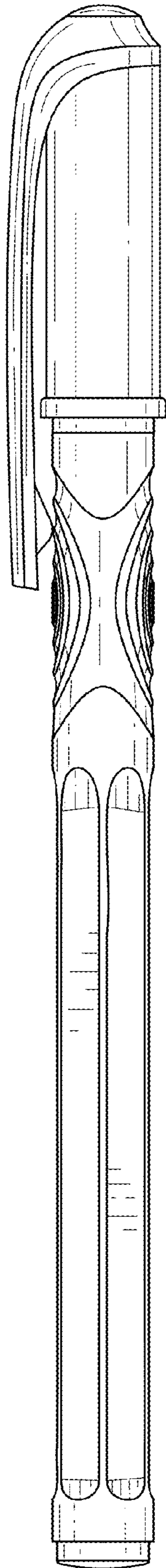

Fig. 4

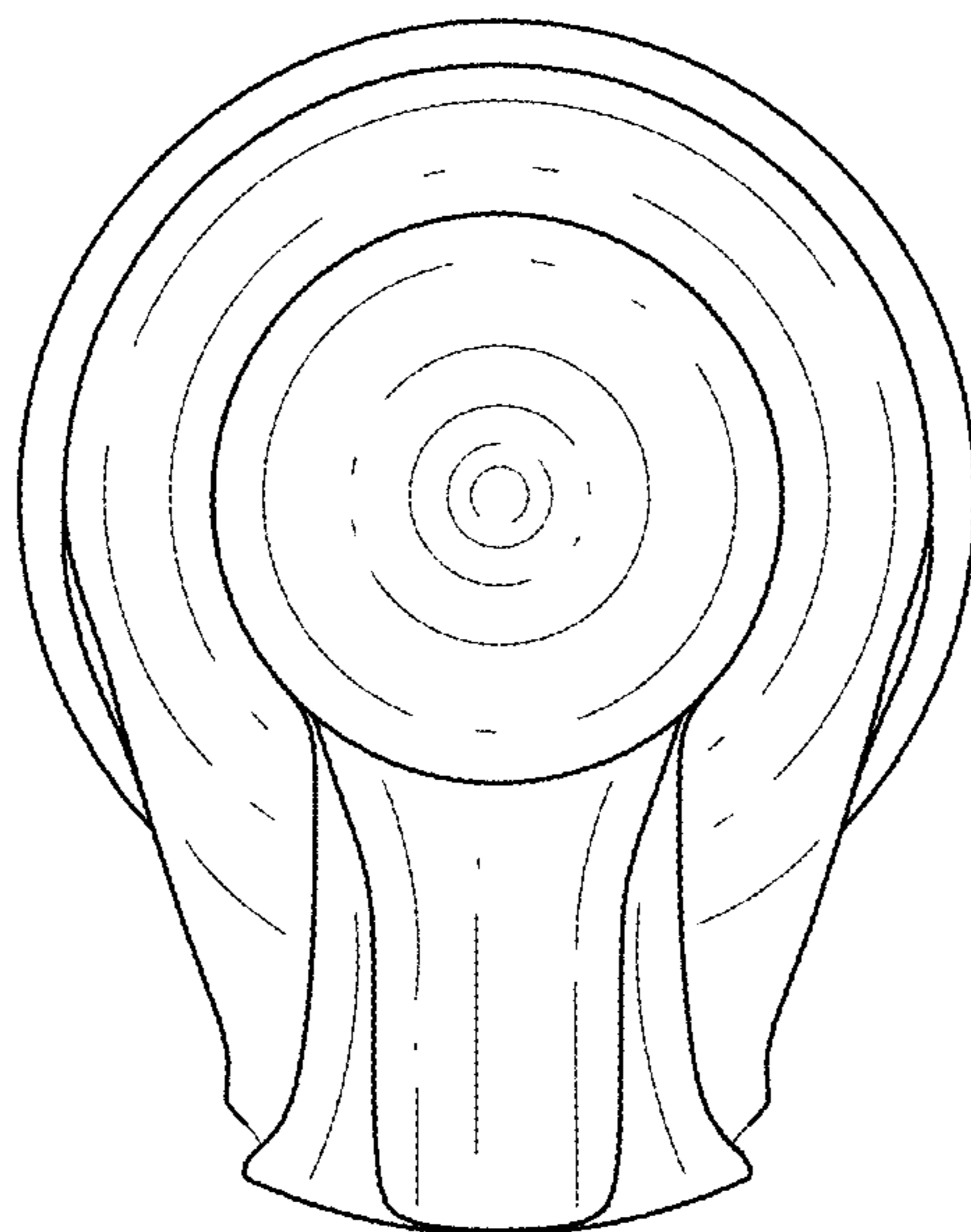

Fig. 5

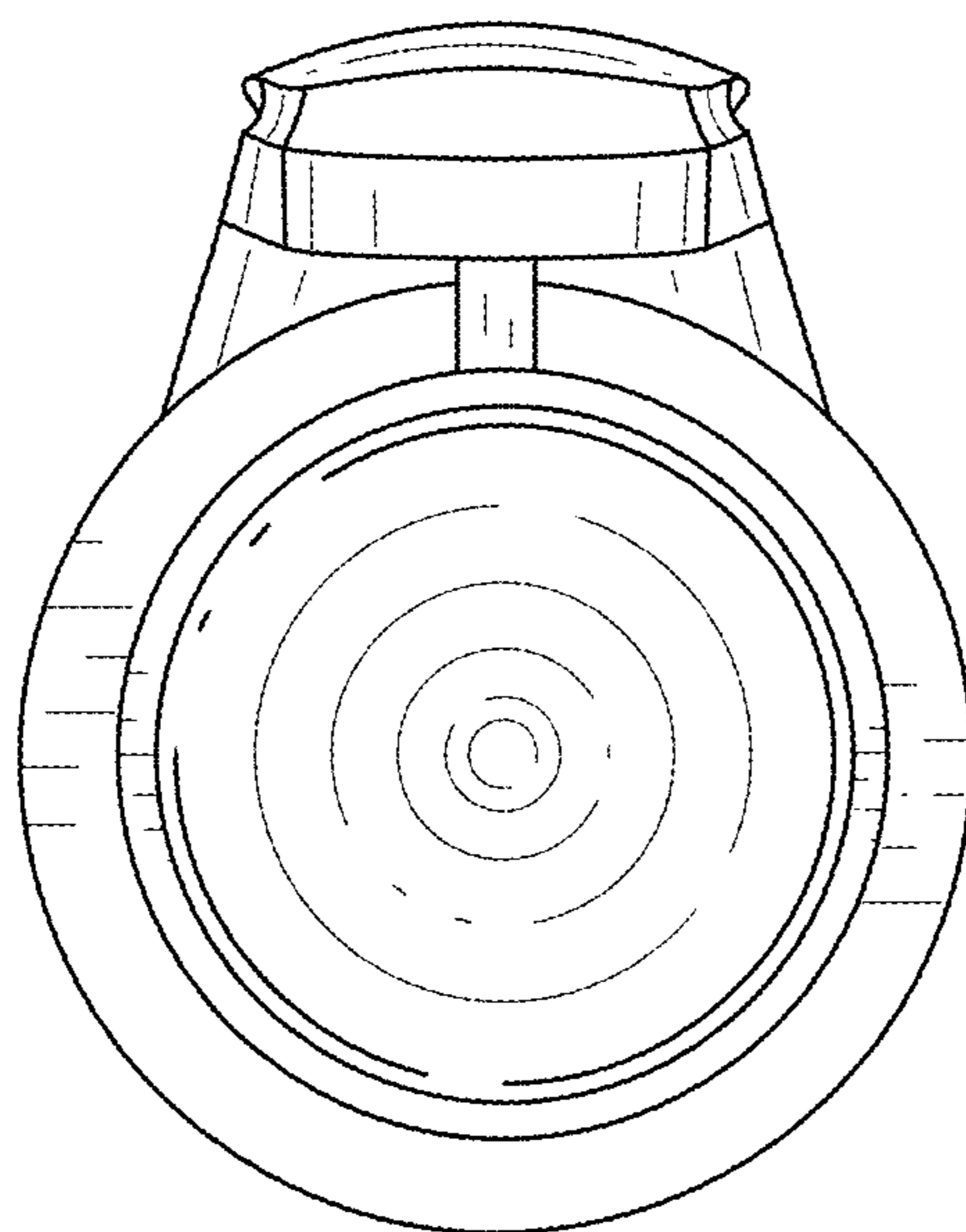

Fig. 6