



US00D683375S

(12) **United States Design Patent**
Yokoi

(10) **Patent No.:** **US D683,375 S**

(45) **Date of Patent:** **** May 28, 2013**

(54) **LASER RANGE FINDER**

(75) Inventor: **Yasuhide Yokoi**, Tokyo (JP)

(73) Assignee: **Nikon Vision Co., Ltd.** (JP)

(**) Term: **14 Years**

(21) Appl. No.: **29/419,745**

(22) Filed: **May 1, 2012**

(30) **Foreign Application Priority Data**

| | | | |
|---------------|------|-------|-------------|
| Jan. 16, 2012 | (JP) | | 2012-000668 |
| Jan. 16, 2012 | (JP) | | 2012-000670 |
| Jan. 16, 2012 | (JP) | | 2012-000673 |

(51) **LOC (9) Cl.** **16-06**

(52) **U.S. Cl.**
USPC **D16/132; D16/136**

(58) **Field of Classification Search**
USPC D16/132, 133, 136, 130, 202, 203,
D16/217; D14/168; 359/816, 817, 819, 630,
359/353; 250/214 VT, 333; 33/290, 291,
33/292, 285; D5/56; D9/418, 434; D7/585;
D2/908; D20/10, 11, 22, 34
See application file for complete search history.

(56) **References Cited**

U.S. PATENT DOCUMENTS

3,454,773 A * 7/1969 Bulthuis et al. 250/214 VT
D216,871 S * 3/1970 Leis D9/418

(Continued)

FOREIGN PATENT DOCUMENTS

JP D1396667 S 9/2010

Primary Examiner — Paula Greene

(74) *Attorney, Agent, or Firm* — Caesar, Rivise, Bernstein,
Cohen & Pokotilow, Ltd.

(57) **CLAIM**

The ornamental design for a laser range finder, as shown and described.

DESCRIPTION

FIG. 1 is a front, top and left side perspective view of a first embodiment of a laser range finder showing my new design; FIG. 2 is a rear, bottom and right side perspective view thereof;

FIG. 3 is a front elevational view thereof;

FIG. 4 is a rear elevational view thereof;

FIG. 5 is a top plan view thereof;

FIG. 6 is a bottom plan view thereof;

FIG. 7 is a right side elevational view thereof;

FIG. 8 is a left side elevational view thereof;

FIG. 9 is a front, top and left side perspective view of a second embodiment of a laser range finder showing my new design;

FIG. 10 is a rear, bottom and right side perspective view thereof;

FIG. 11 is a front elevational view thereof;

FIG. 12 is a rear elevational view thereof;

FIG. 13 is a top plan view thereof;

FIG. 14 is a bottom plan view thereof;

FIG. 15 is a right side elevational view thereof;

FIG. 16 is a left side elevational view thereof;

FIG. 17 is a front, top and left side perspective view of a third embodiment of a laser range finder showing my new design;

FIG. 18 is a rear, bottom and right side perspective view thereof;

FIG. 19 is a front elevational view thereof;

FIG. 20 is a rear elevational view thereof;

FIG. 21 is a top plan view thereof;

FIG. 22 is a bottom plan view thereof;

FIG. 23 is a right side elevational view thereof; and,

FIG. 24 is a left side elevational view thereof.

The features shown in broken lines in the drawings depict environmental subject matter only and form no part of the claimed design. The dot-dashed lines denote the boundary of the claim, and form no part of the claimed design.

1 Claim, 24 Drawing Sheets

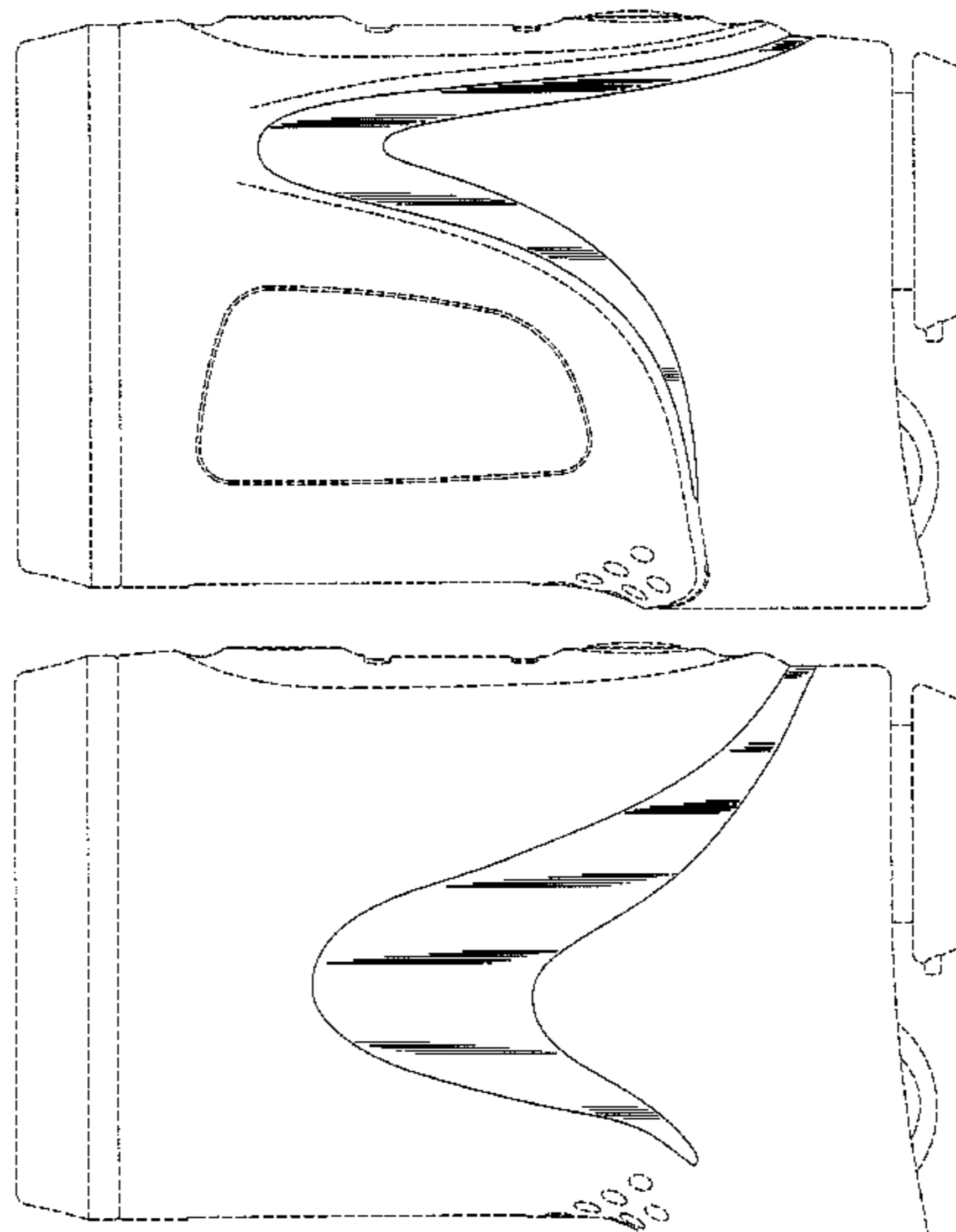

U.S. PATENT DOCUMENTS

| | | | | | | | | | |
|---------------|---------|-------------------|-------|---------|----------------|---------|-----------------|-------|------------|
| D240,333 S * | 6/1976 | Chesnut | | D16/132 | D543,460 S * | 5/2007 | Perry et al. | | D9/516 |
| D275,575 S * | 9/1984 | Henderson | | D16/131 | D544,515 S * | 6/2007 | Walter et al. | | D16/203 |
| D313,020 S * | 12/1990 | Ichikawa | | D14/192 | D547,780 S * | 7/2007 | Meinzer | | D16/132 |
| D318,676 S * | 7/1991 | Imai et al. | | D16/202 | D551,565 S * | 9/2007 | Wouters et al. | | D9/704 |
| 5,455,711 A * | 10/1995 | Palmer | | 359/353 | D554,501 S * | 11/2007 | Bone et al. | | D9/434 |
| 5,495,364 A * | 2/1996 | Palmer | | 359/412 | D556,572 S * | 12/2007 | Mongeon et al. | | D9/432 |
| D371,786 S * | 7/1996 | Maeyama | | D14/168 | D564,553 S * | 3/2008 | Yip et al. | | D16/131 |
| 5,867,313 A * | 2/1999 | Schweitzer et al. | | 359/418 | D567,080 S * | 4/2008 | Bone et al. | | D9/432 |
| D424,081 S * | 5/2000 | Gordon | | D16/130 | 7,420,153 B2 * | 9/2008 | Palmer et al. | | 250/214 VT |
| D433,430 S * | 11/2000 | Meinzer | | D16/132 | D586,210 S * | 2/2009 | Noschang et al. | | D9/434 |
| D508,705 S * | 8/2005 | Hayamizu | | D16/133 | D599,657 S * | 9/2009 | Bruno et al. | | D9/434 |
| D511,538 S * | 11/2005 | Hayamizu | | D16/133 | D600,551 S * | 9/2009 | Bruno et al. | | D9/434 |
| D523,886 S * | 6/2006 | Wen et al. | | D16/202 | D606,572 S * | 12/2009 | Samson et al. | | D16/203 |
| D532,026 S * | 11/2006 | Sosniak et al. | | D16/130 | D615,397 S * | 5/2010 | Arnell | | D9/434 |
| D537,459 S * | 2/2007 | Yip et al. | | D16/131 | D621,702 S * | 8/2010 | Tekulve et al. | | D9/432 |
| D537,465 S * | 2/2007 | Tainaka | | D16/219 | D627,378 S * | 11/2010 | Watanabe | | D16/133 |
| D539,317 S * | 3/2007 | Tonhofer | | D16/132 | D651,628 S * | 1/2012 | Wang | | D16/132 |
| D540,680 S * | 4/2007 | Perry et al. | | D9/516 | D662,118 S * | 6/2012 | Soejima | | D16/133 |
| D543,112 S * | 5/2007 | Bridgman et al. | | D9/516 | | | | | |

* cited by examiner

FIG. 1

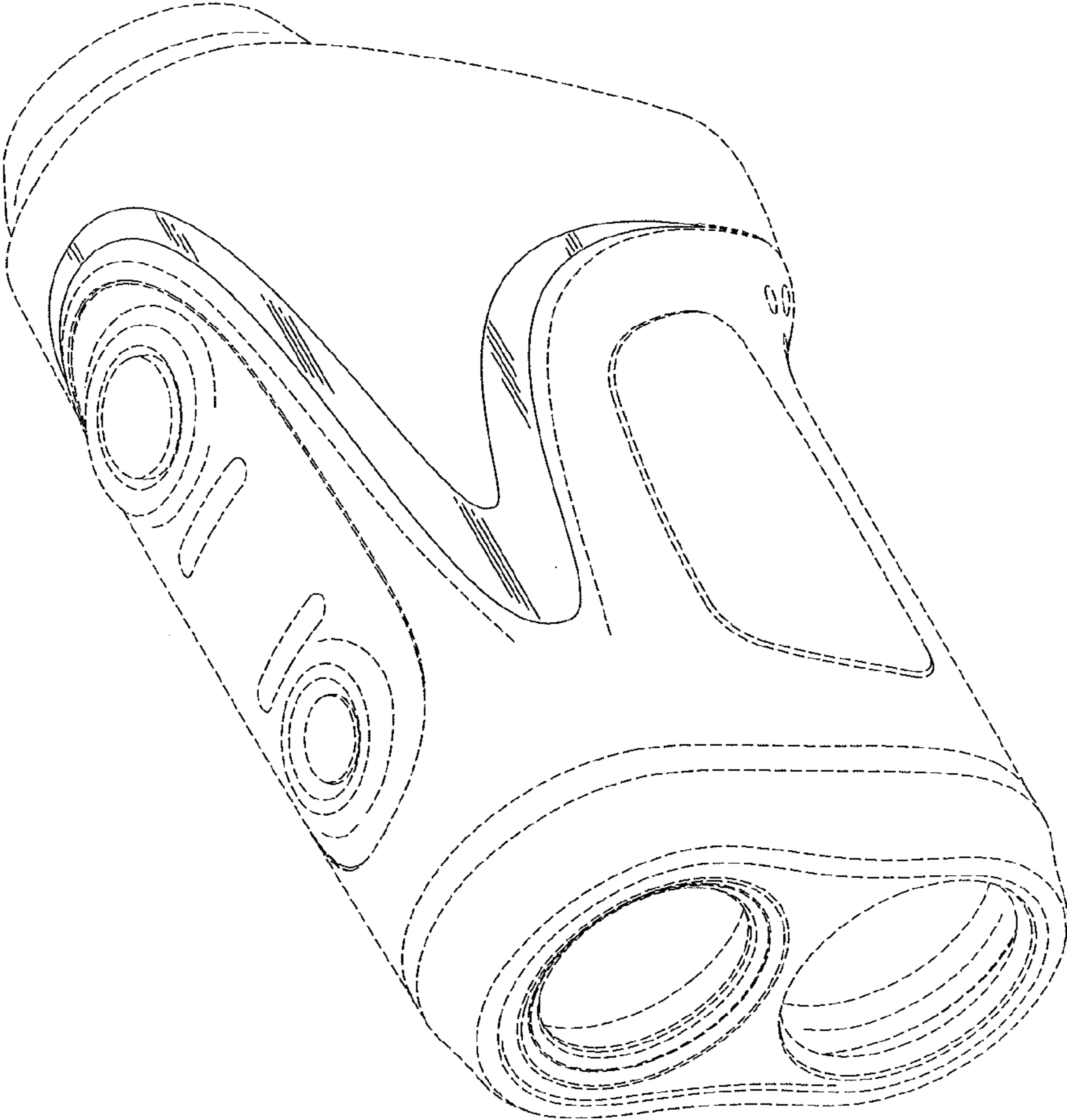

FIG. 2

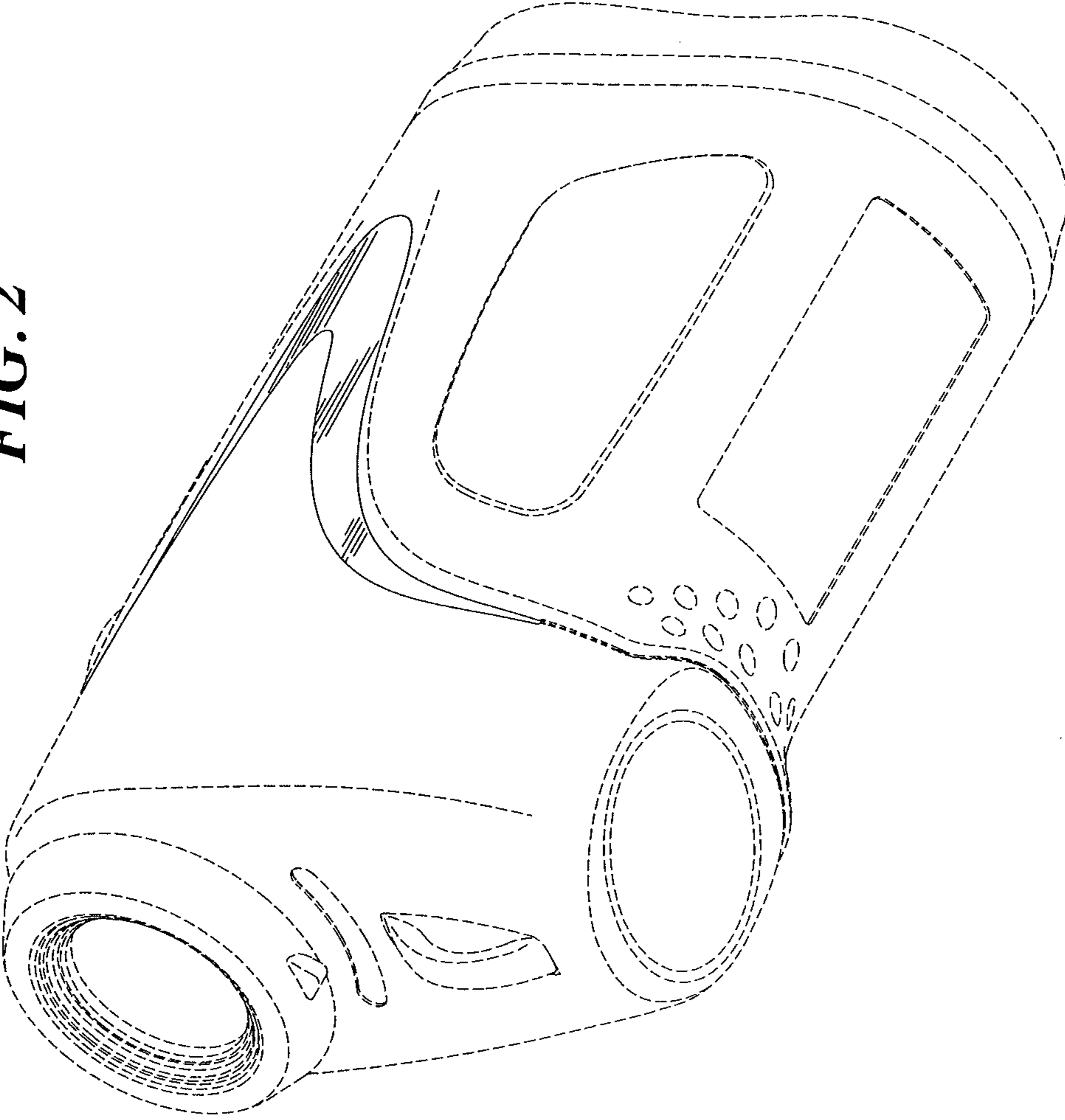

FIG. 3

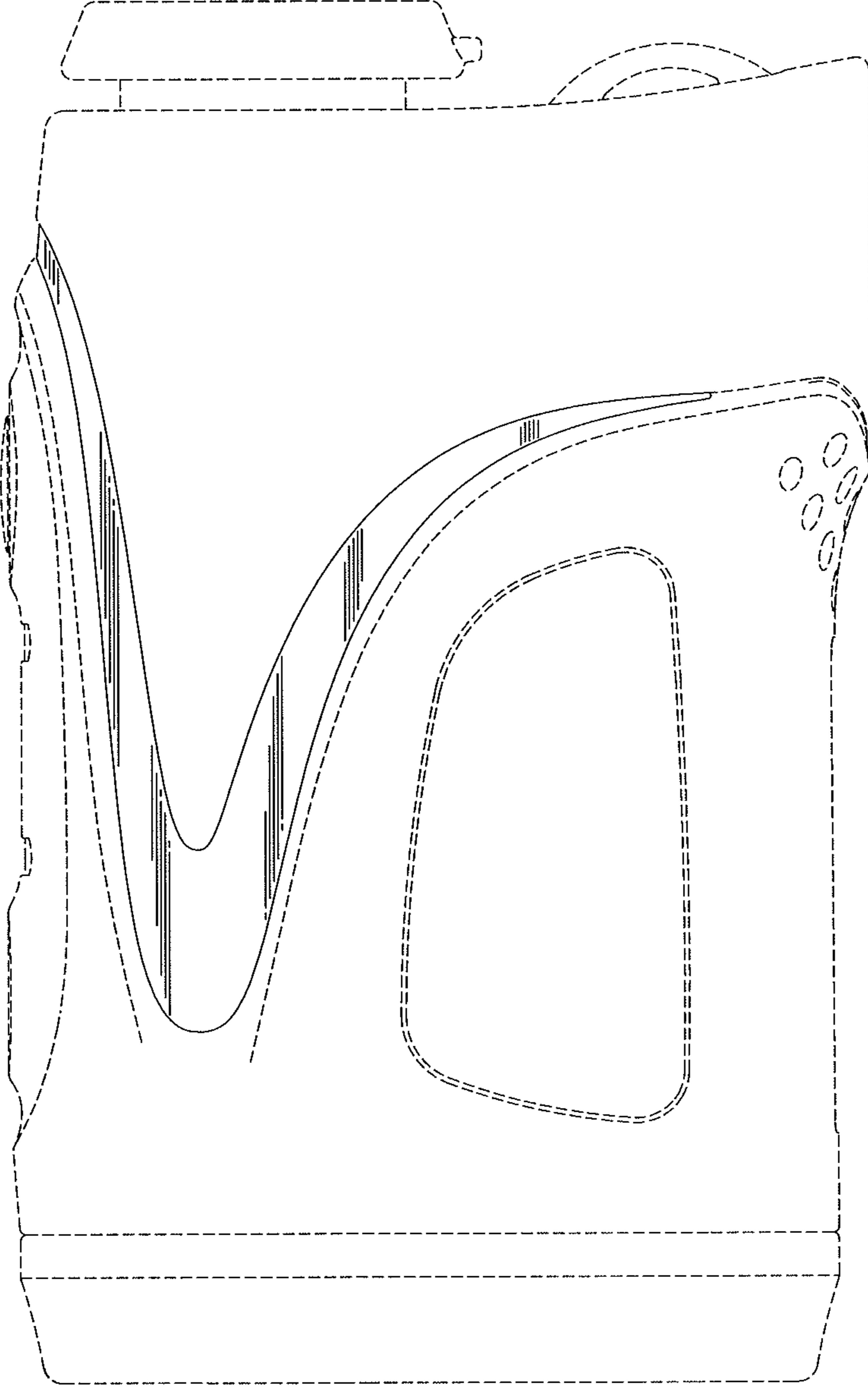

FIG. 4

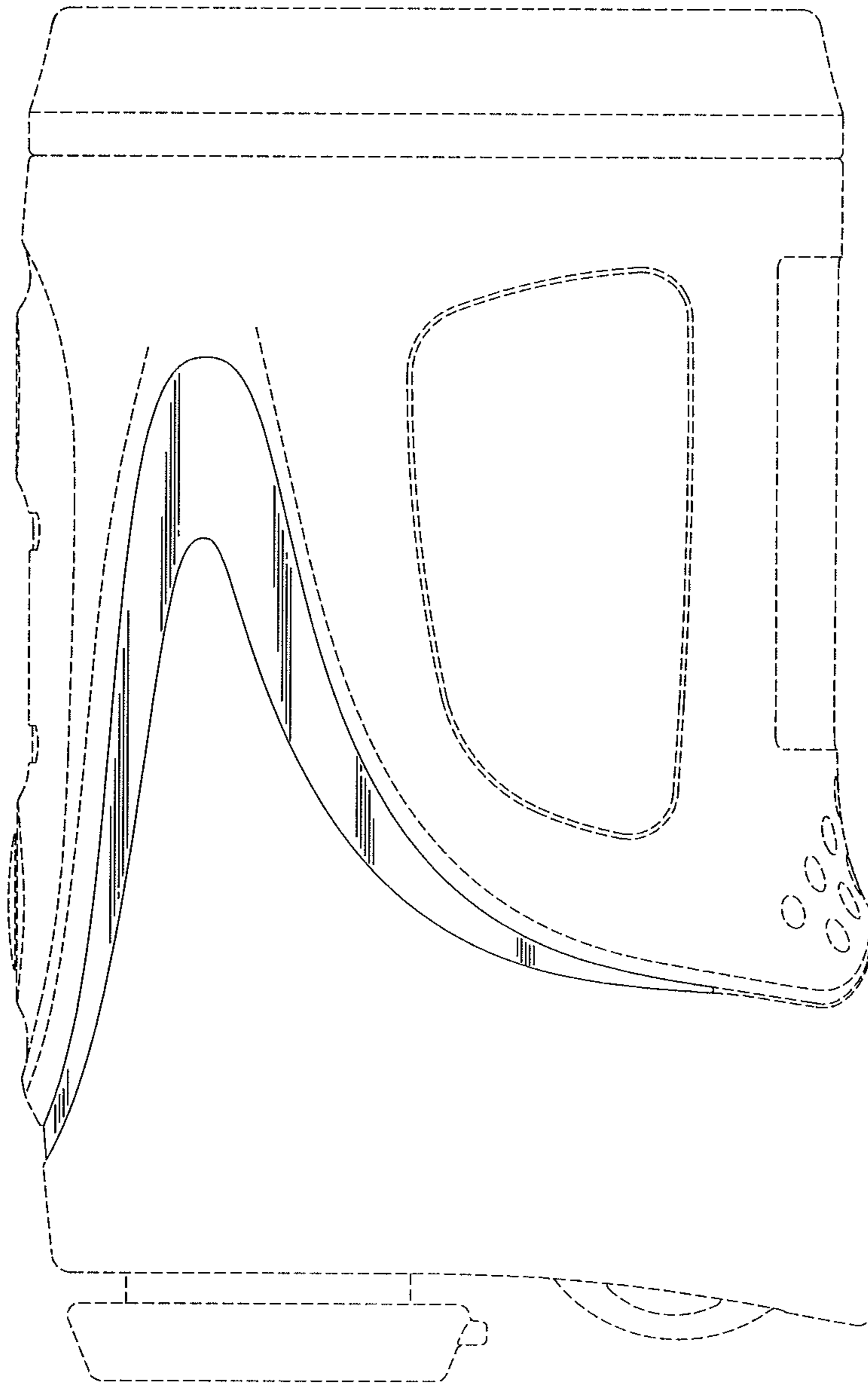

FIG. 5

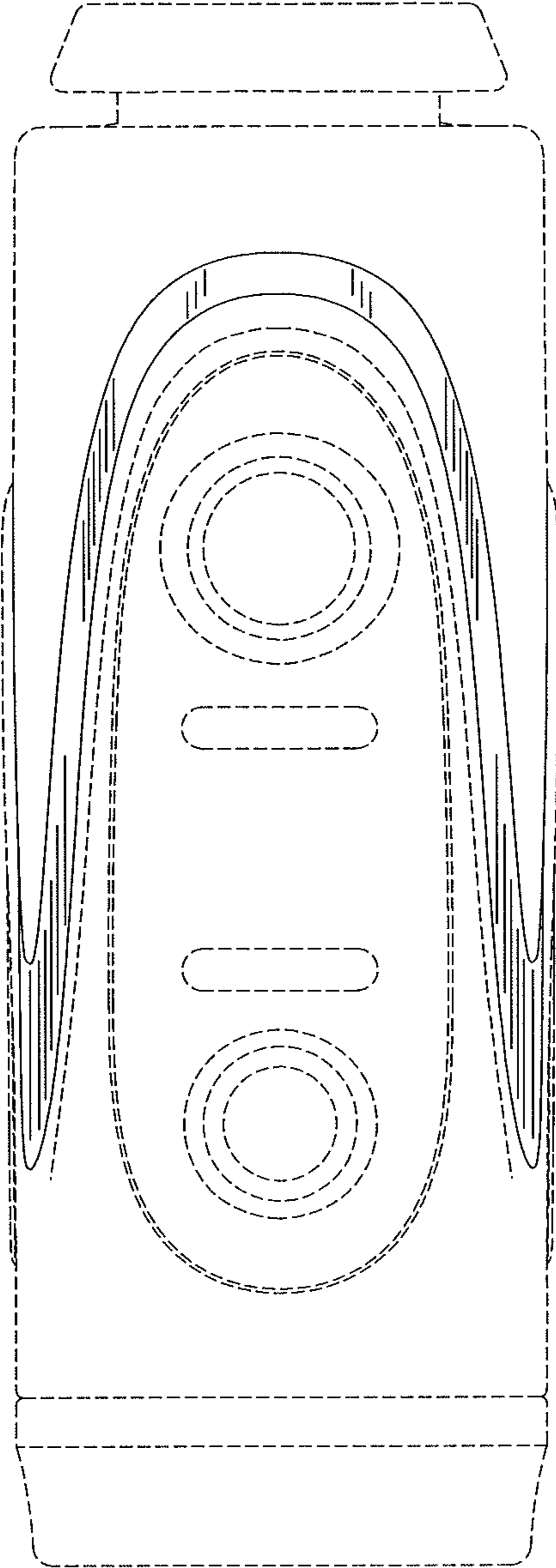

FIG. 6

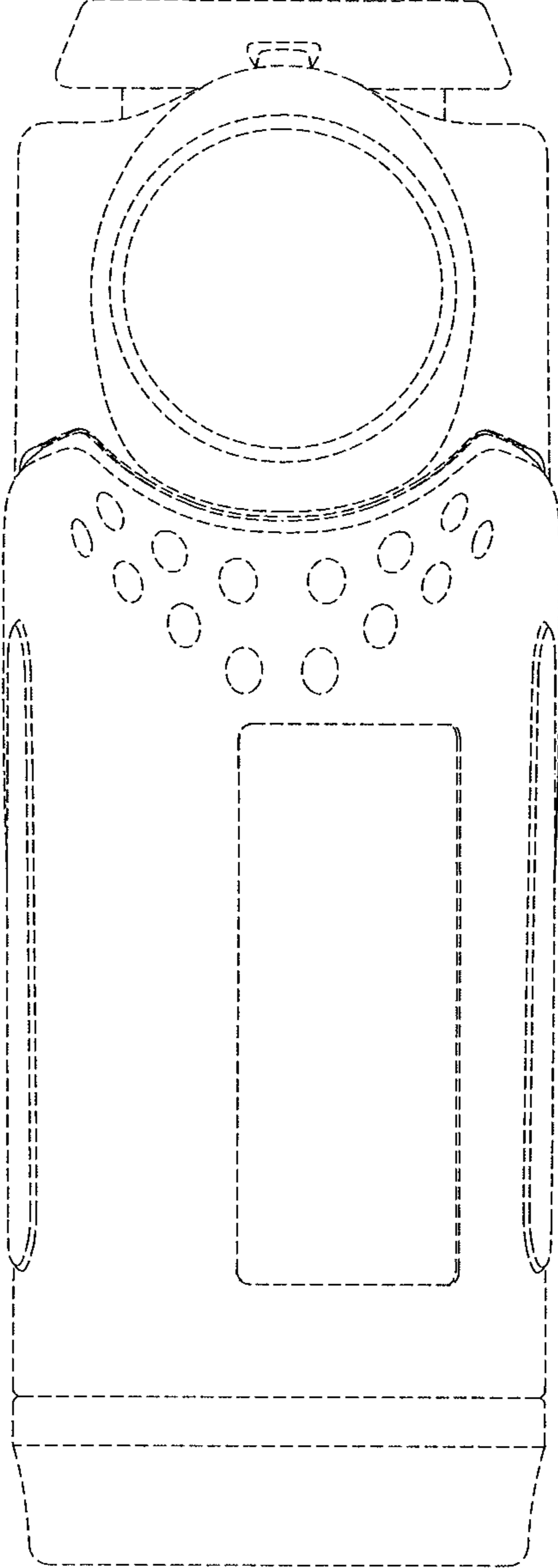

FIG. 7

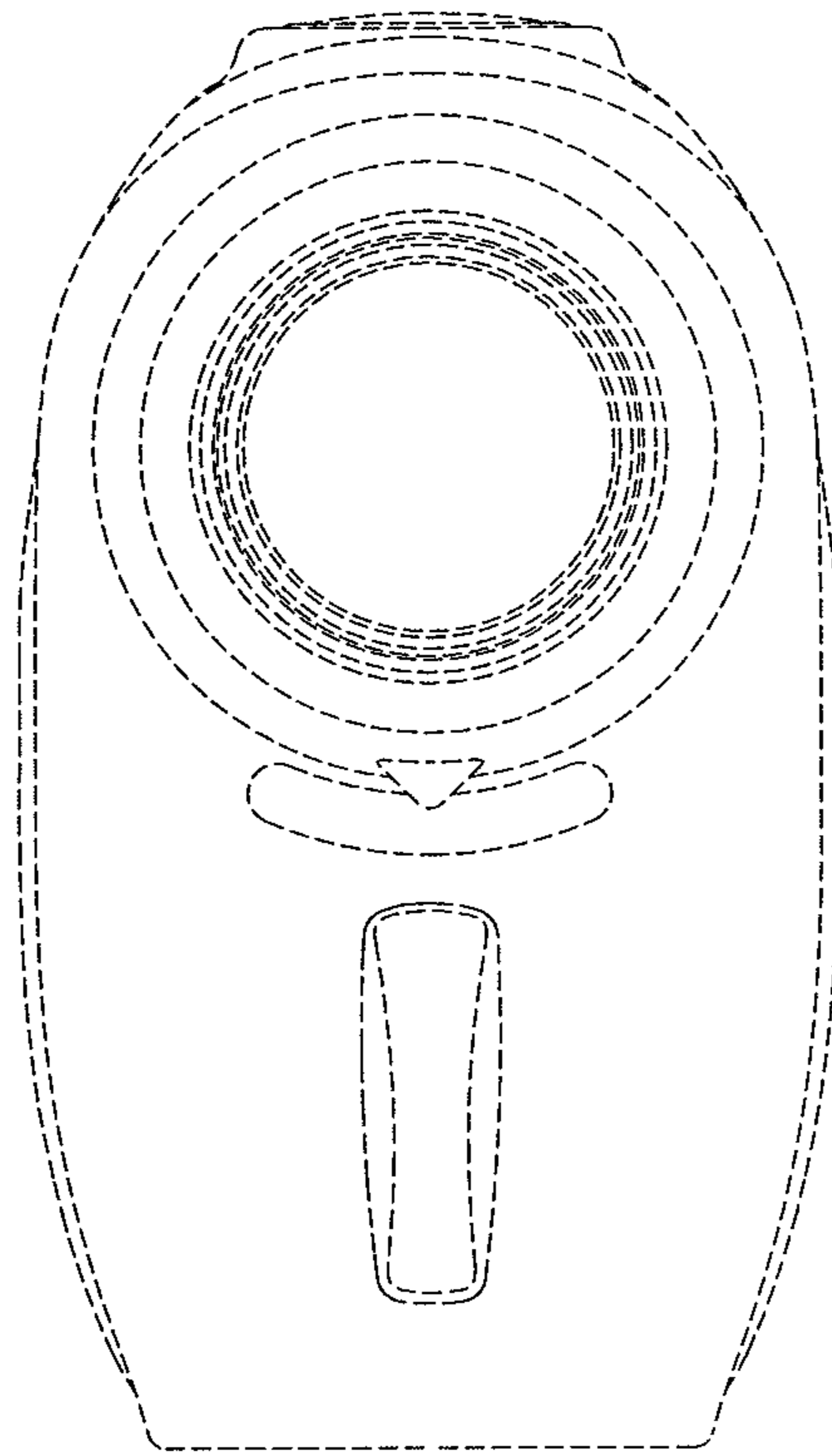

FIG. 8

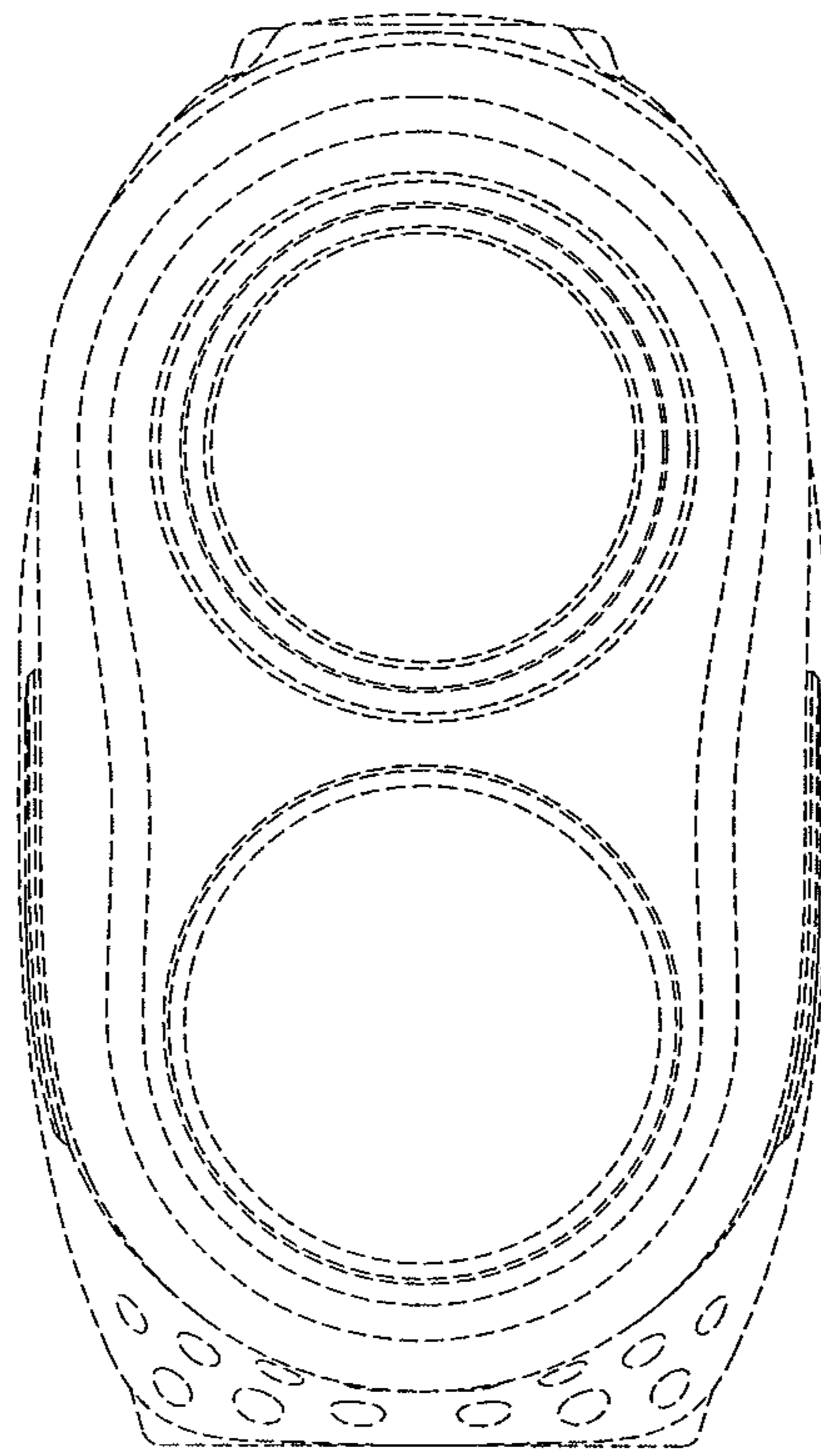

FIG. 9

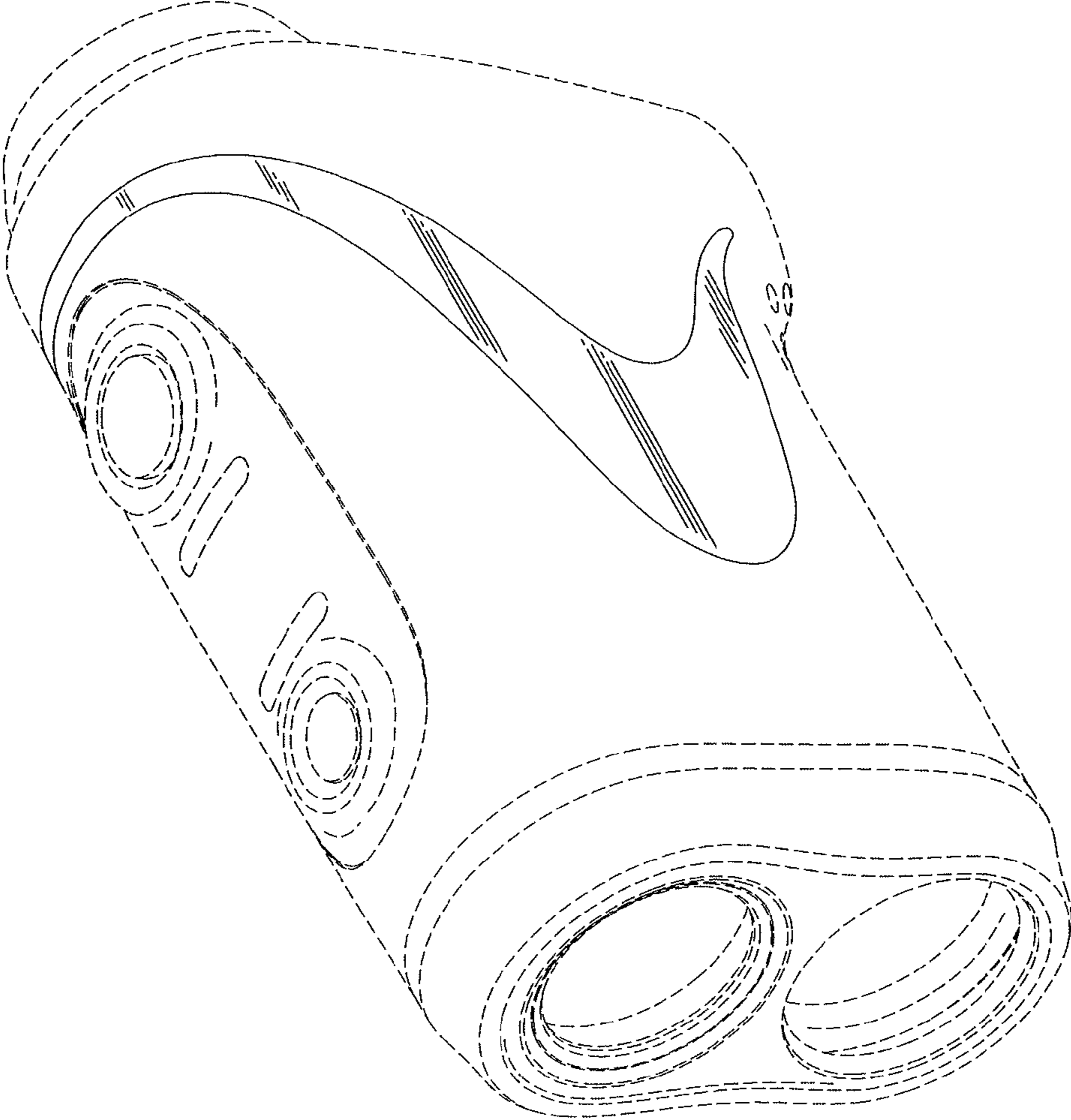

FIG. 10

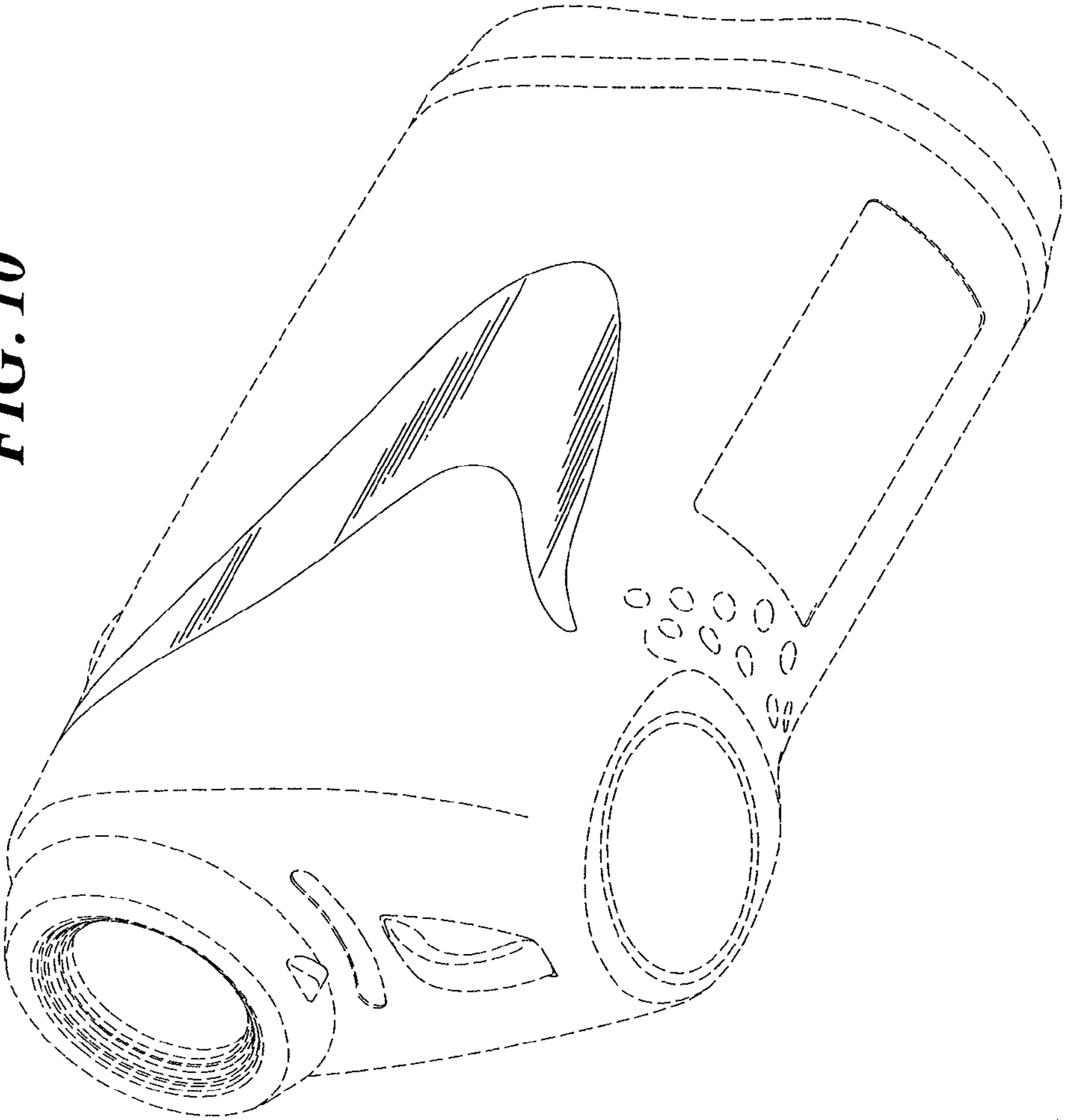

FIG. 11

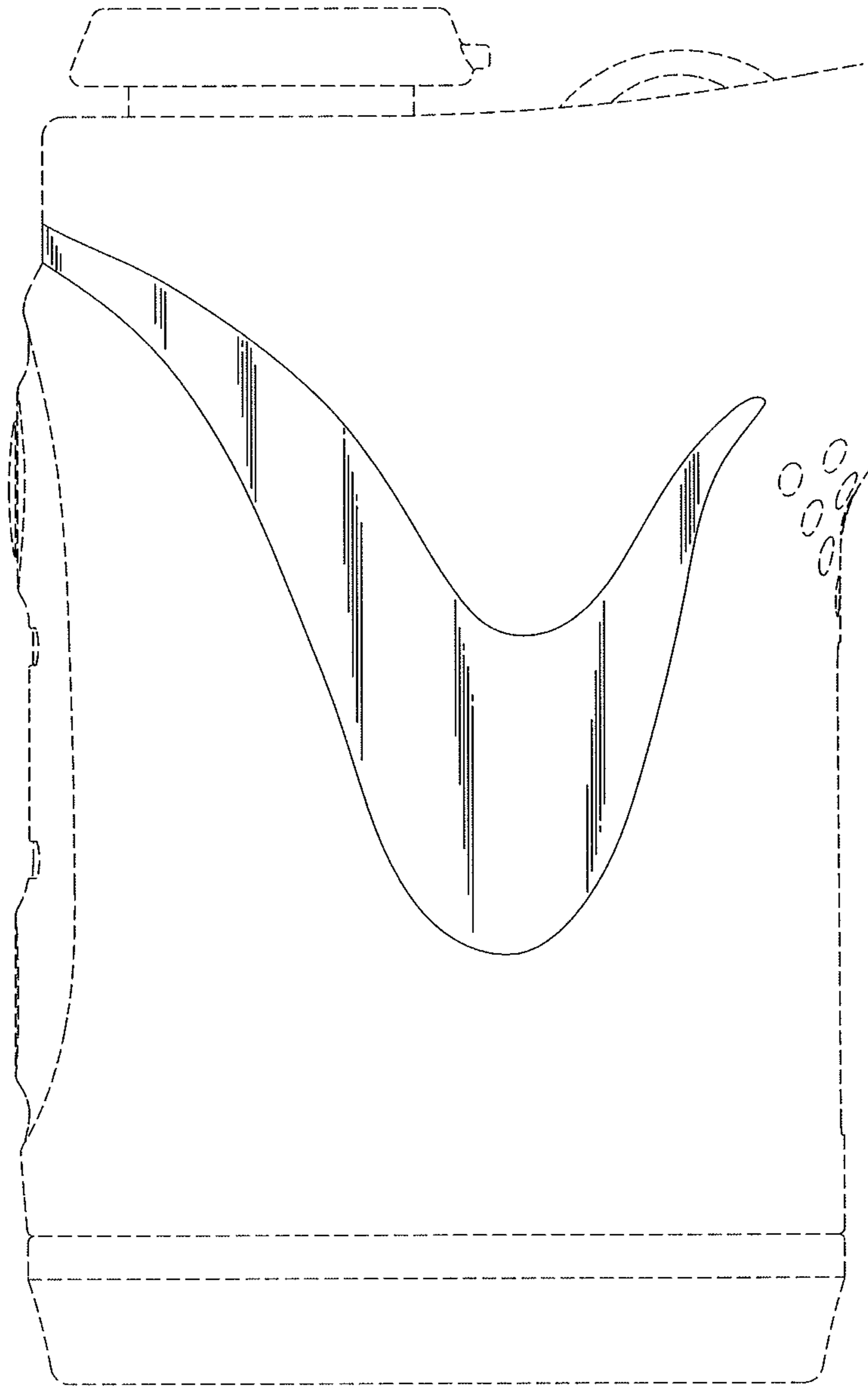

FIG. 12

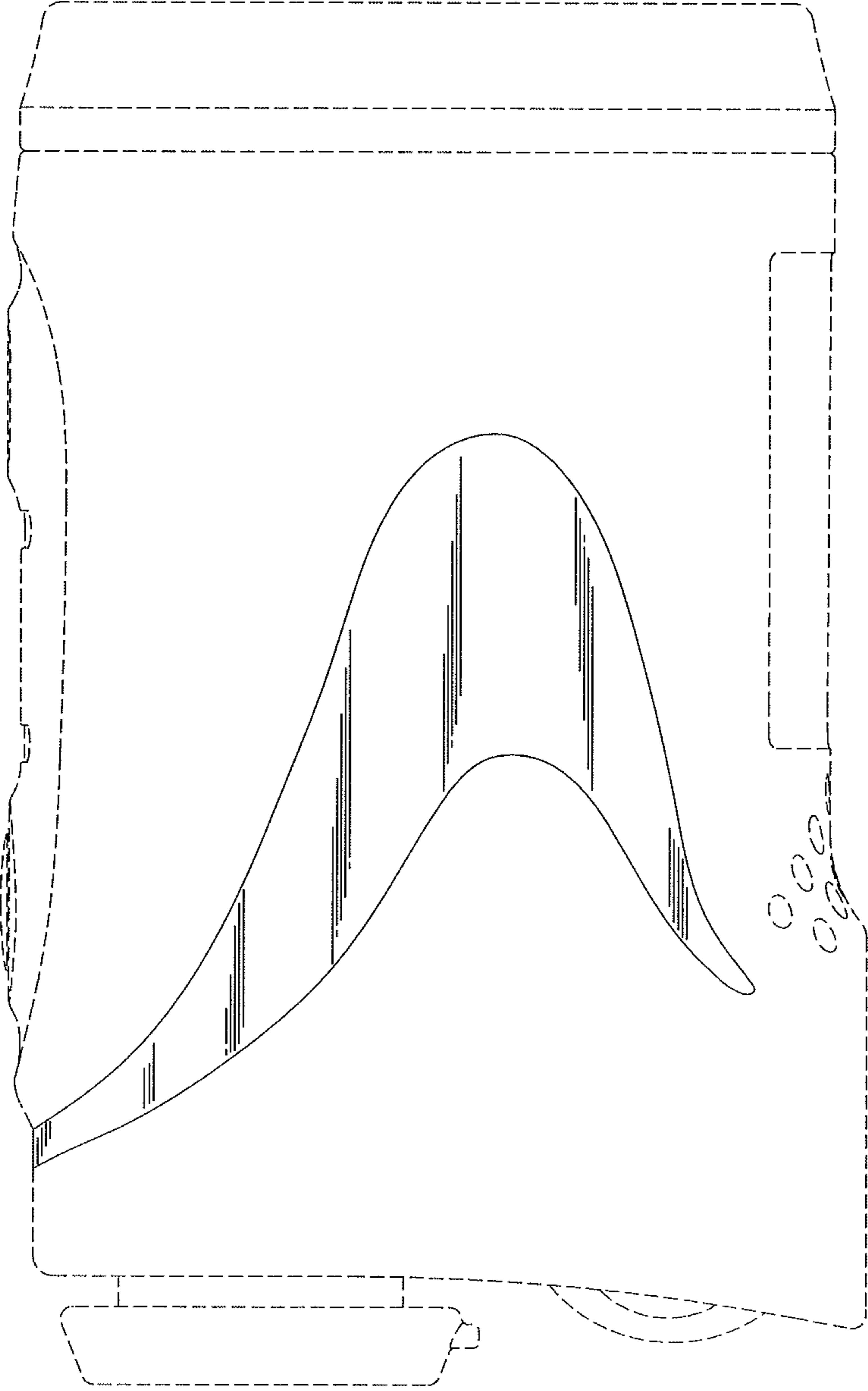

FIG. 13

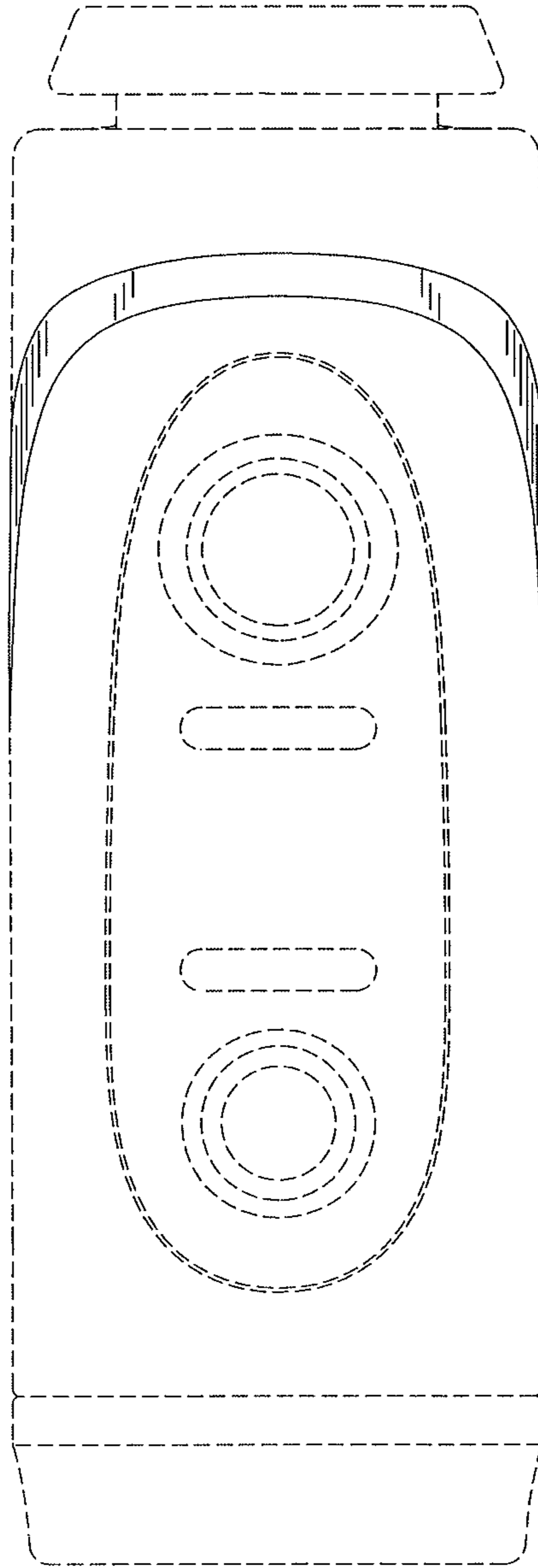

FIG. 14

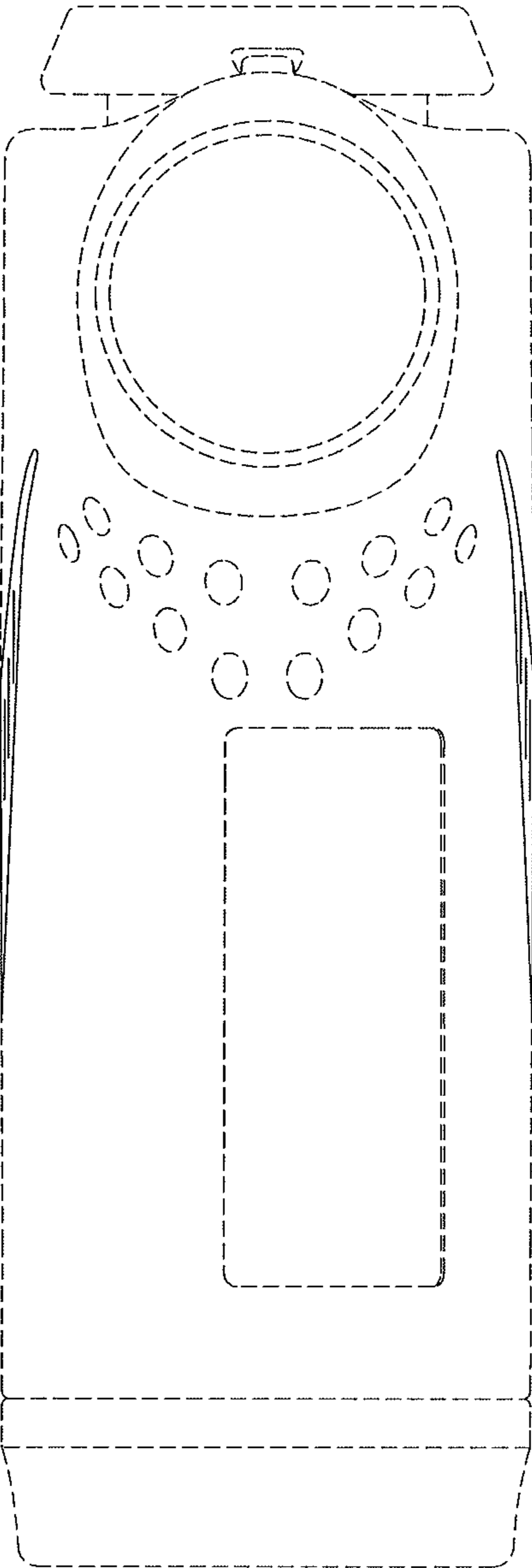

FIG. 15

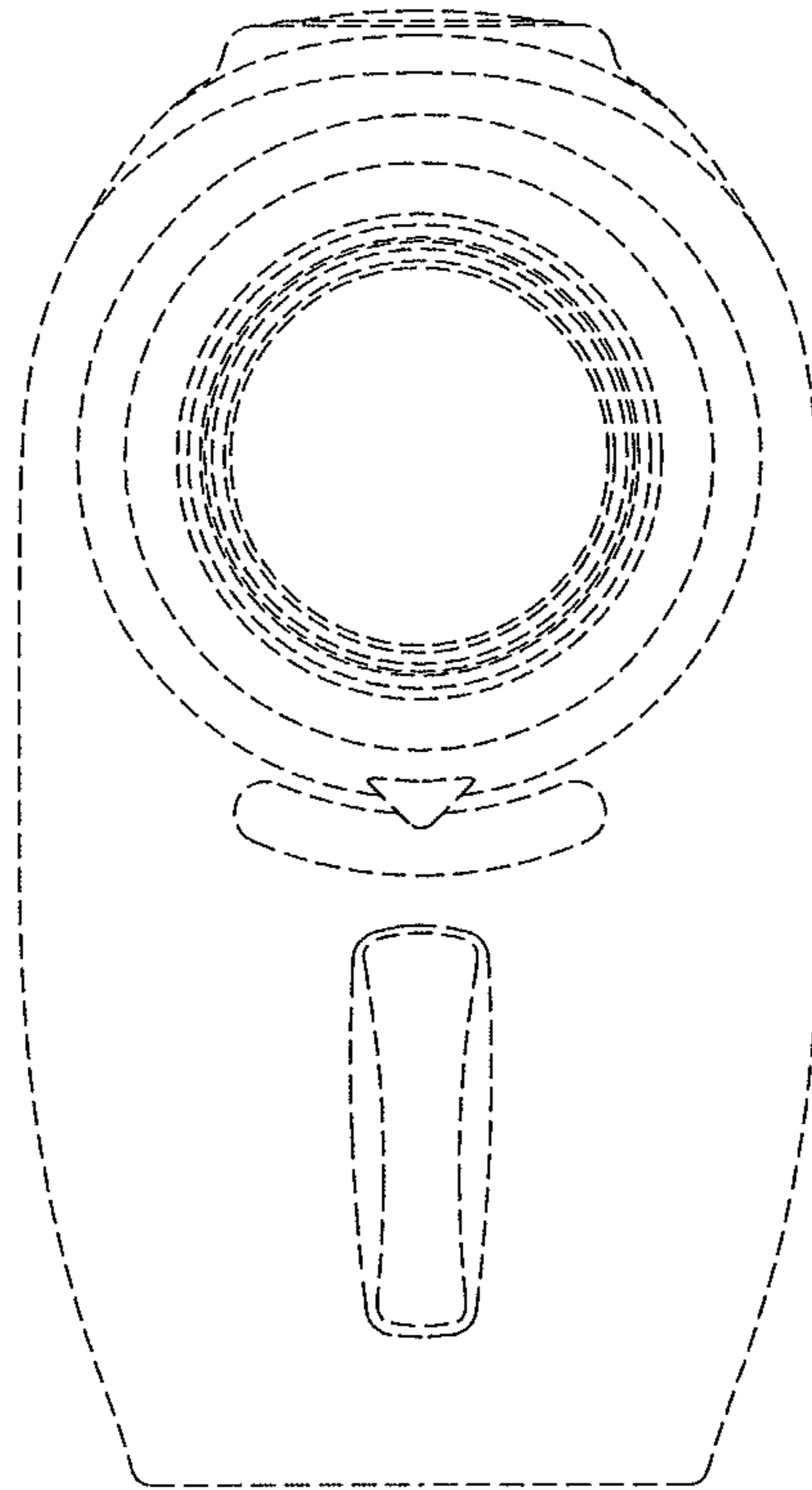

FIG. 16

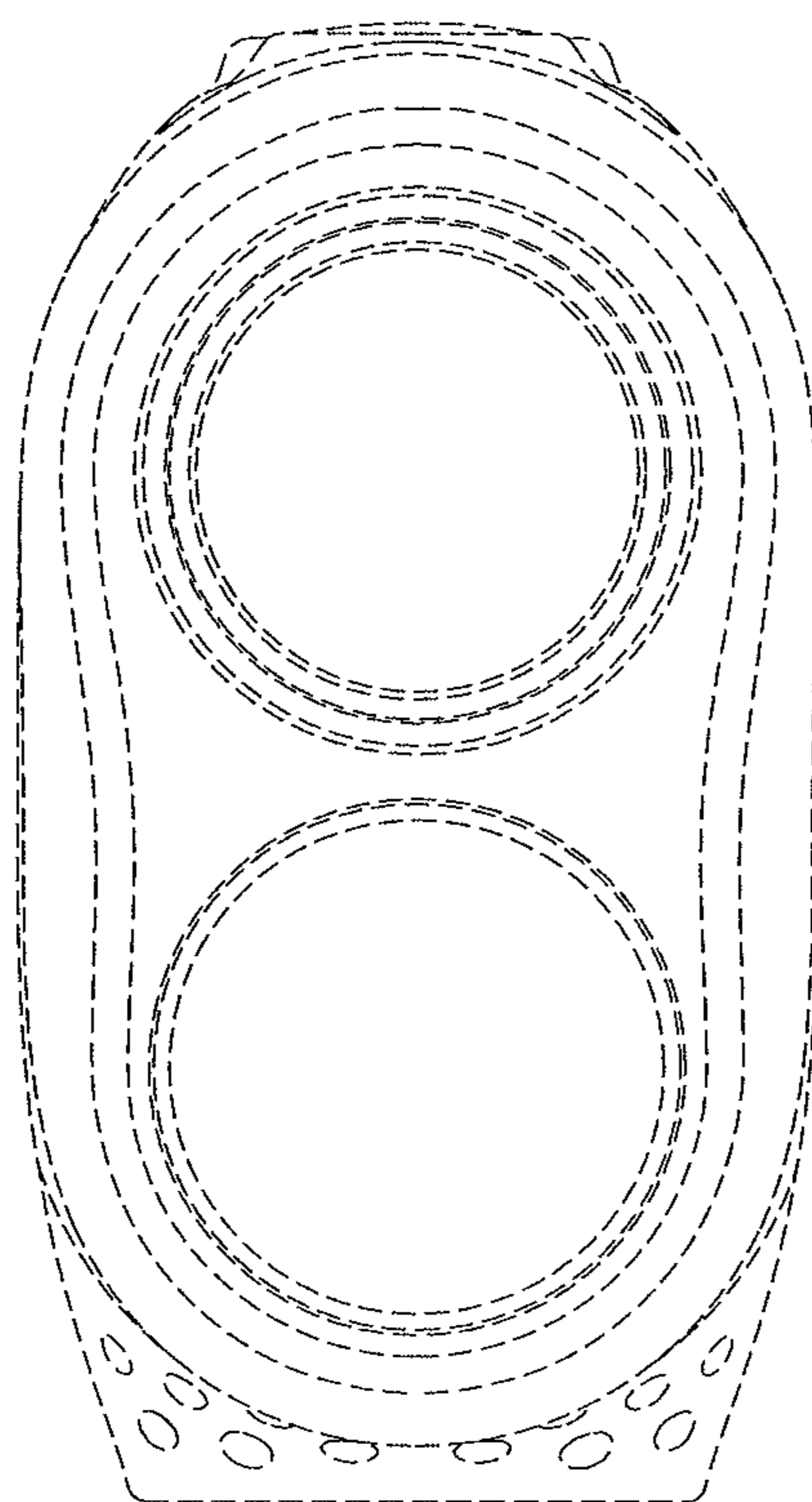

FIG. 17

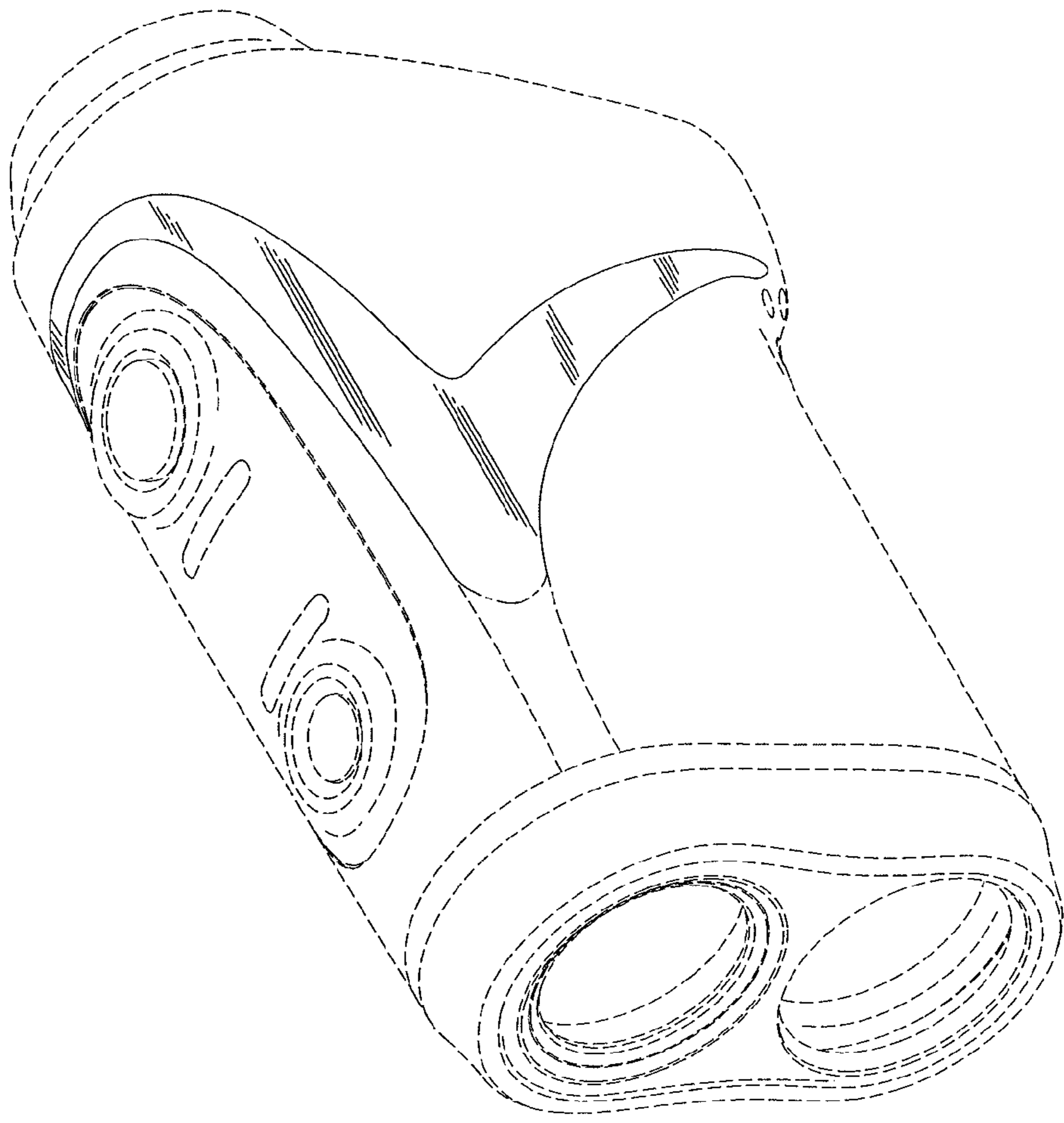

FIG. 18

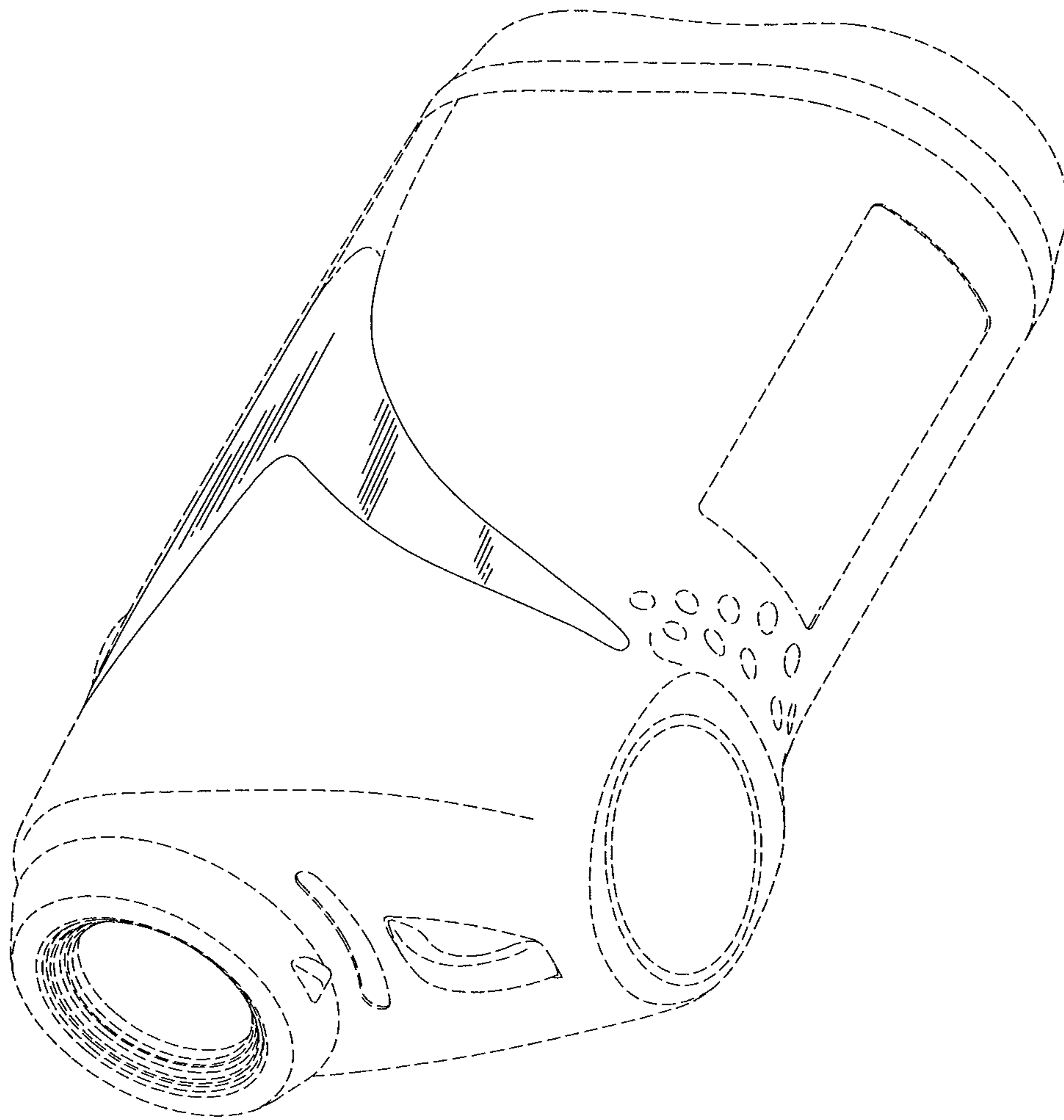

FIG. 19

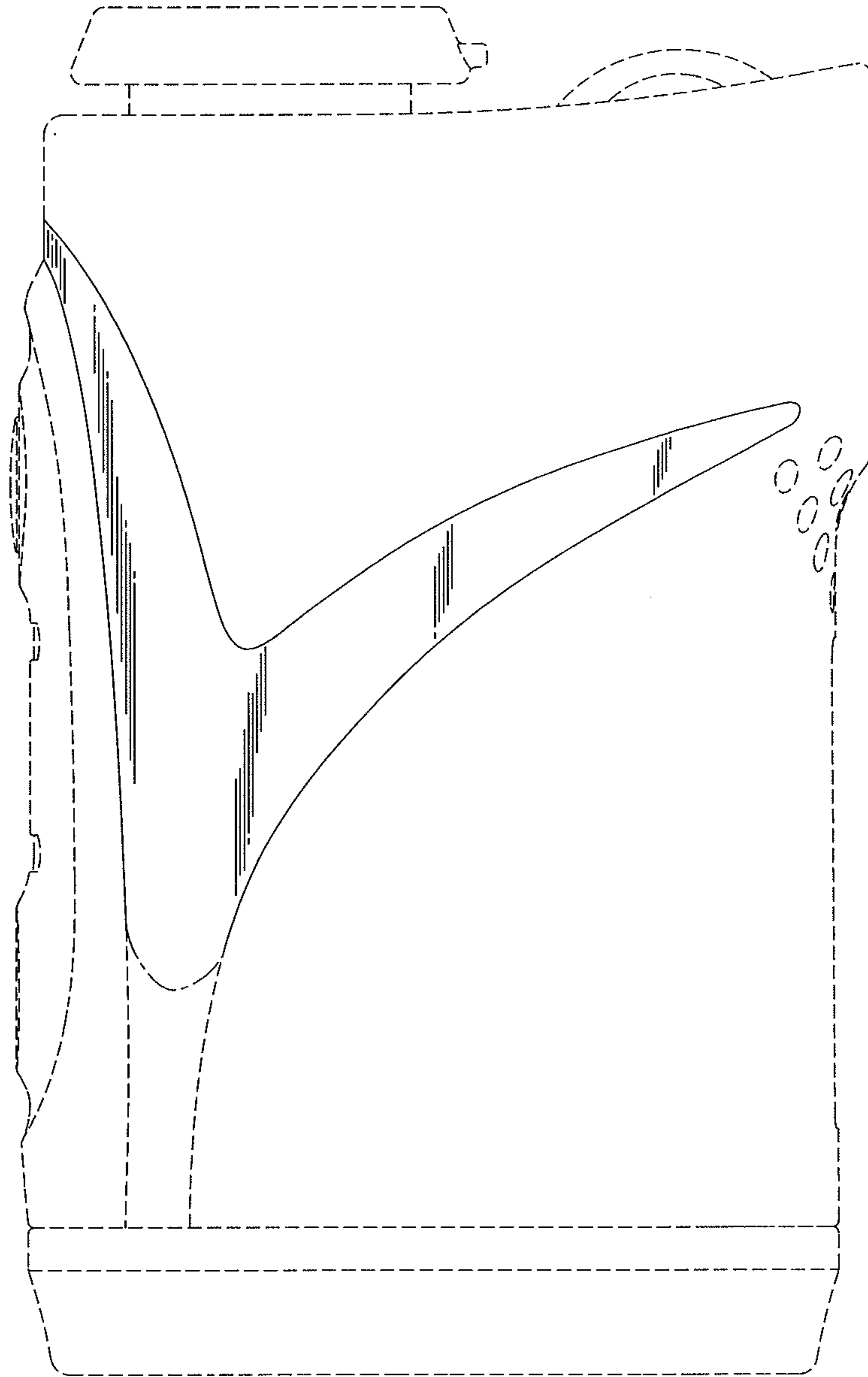

FIG. 20

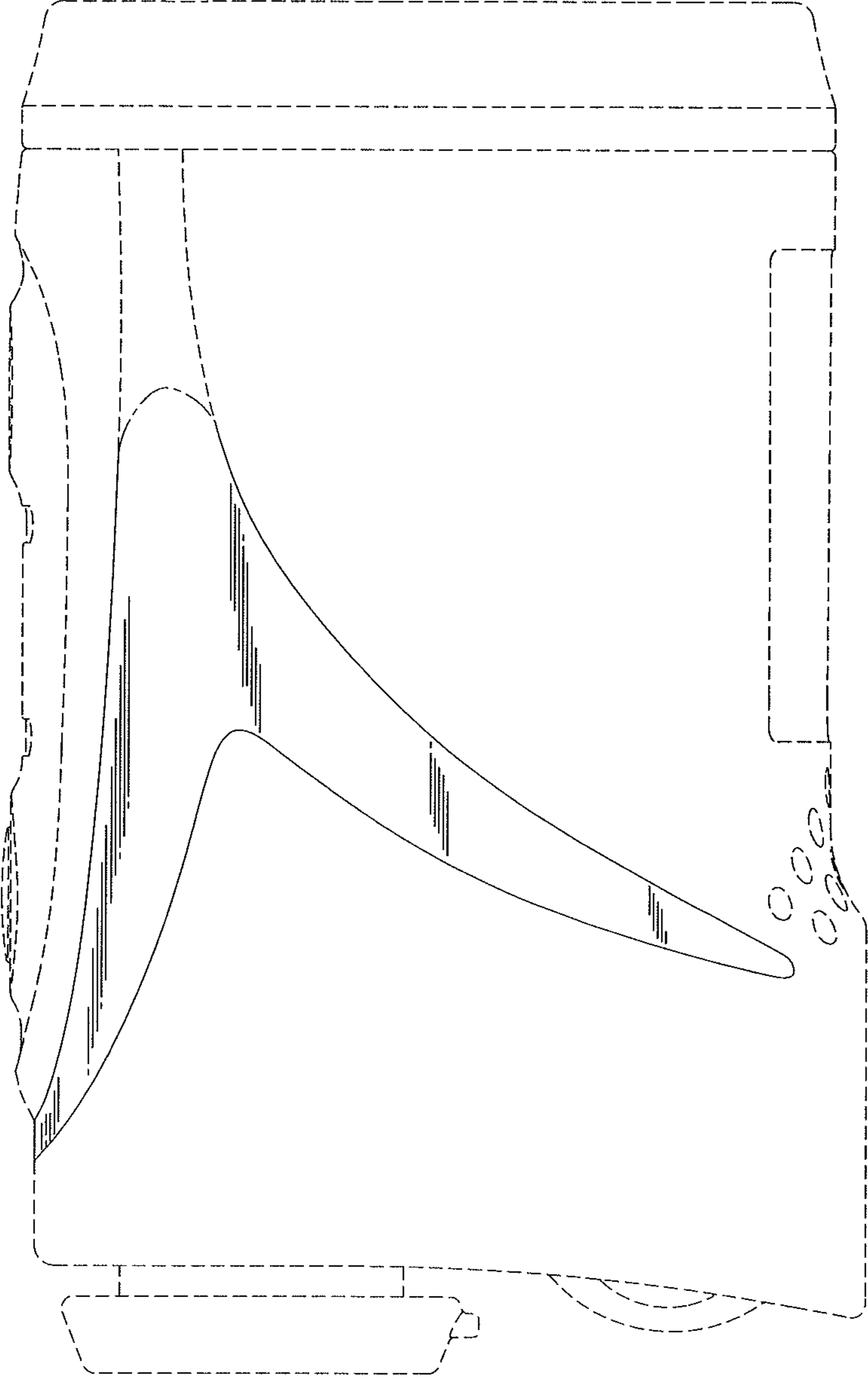

FIG. 21

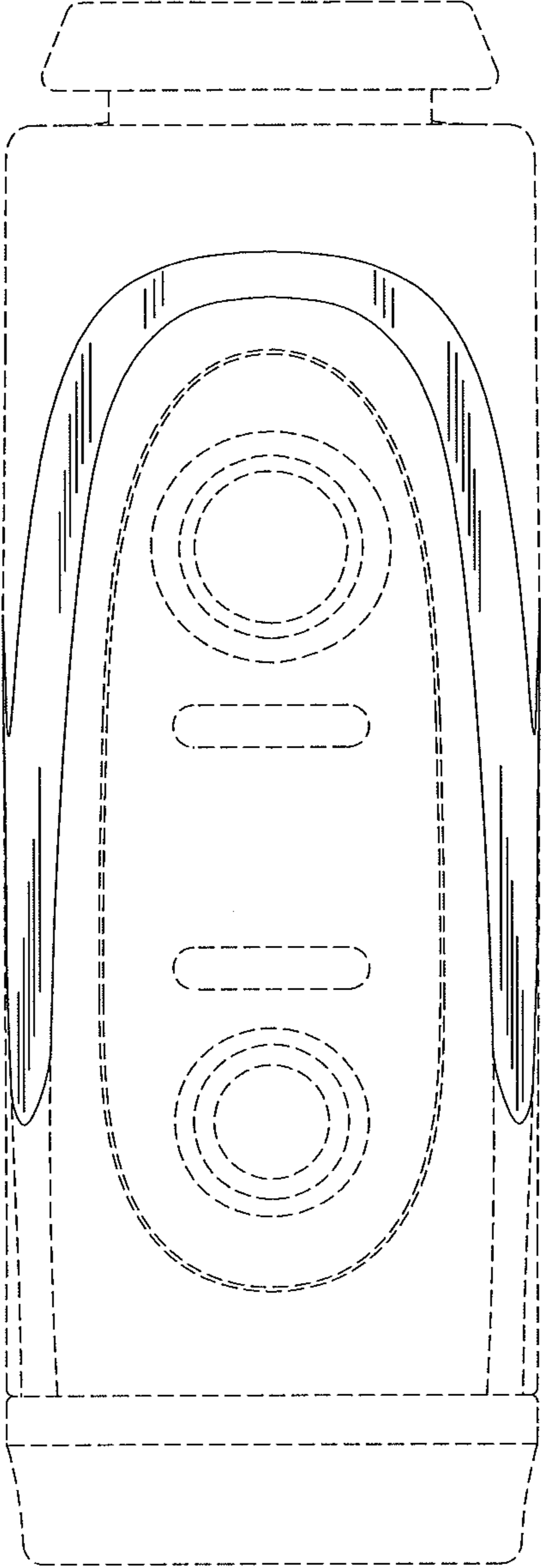

FIG. 22

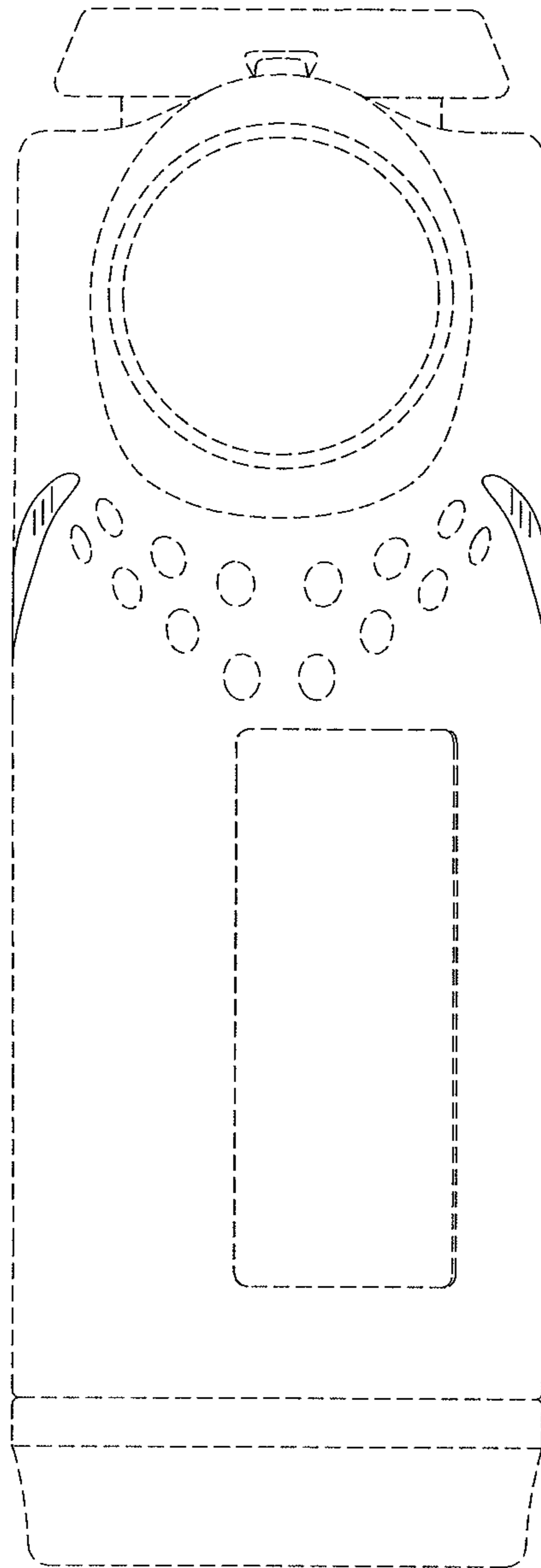

FIG. 23

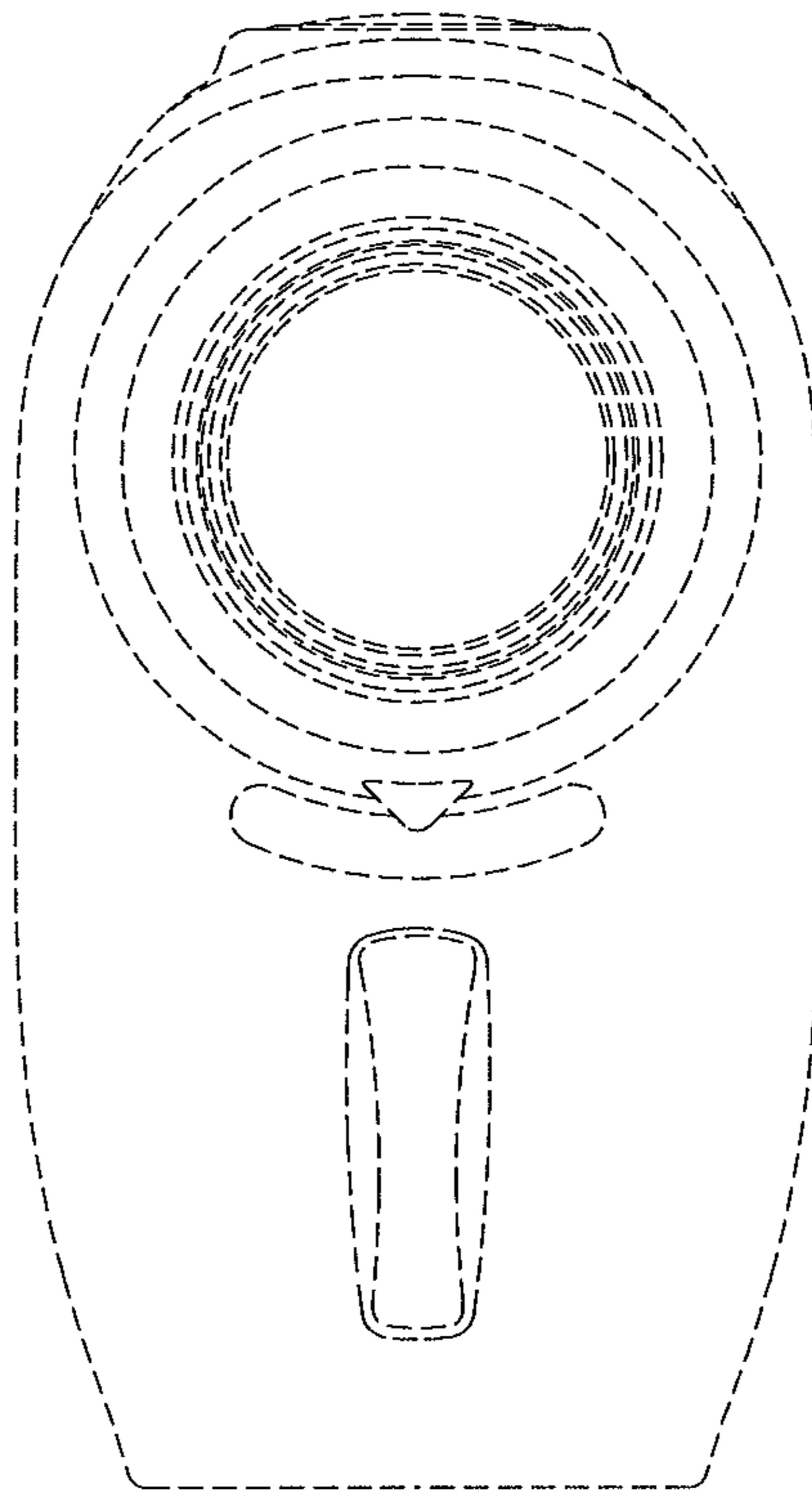

FIG. 24

