



US00D683245S

(12) **United States Design Patent**  
**Palmer et al.**

(10) **Patent No.:** **US D683,245 S**

(45) **Date of Patent:** **\*\* May 28, 2013**

(54) **PACKAGING FOR SANITATION GLOVES**

(75) Inventors: **Brian Palmer**, Highwood, IL (US);  
**Emily Somers**, Cary, IL (US)

(73) Assignee: **Medline Industries, Inc.**, Mundelein, IL (US)

(\*\*) Term: **14 Years**

(21) Appl. No.: **29/417,572**

(22) Filed: **Apr. 5, 2012**

(51) **LOC (9) Cl.** ..... **09-01**

(52) **U.S. Cl.**  
USPC ..... **D9/734**

(58) **Field of Classification Search** ..... D9/414,  
D9/416, 418, 421, 423, 426, 432, 433, 436,  
D9/443, 447, 500, 502, 503, 516, 517, 519,  
D9/529, 531; 206/233, 390, 409, 444, 494,  
206/503, 504, 509, 812, 823, 824; 221/26,  
221/33, 45, 48, 63; D6/515-523; D3/203.1,  
D3/203.5, 203.6; 229/238, 242, 915  
See application file for complete search history.

(56) **References Cited**

U.S. PATENT DOCUMENTS

1,716,628	A *	6/1929	Gittleman	221/63
2,287,420	A *	6/1942	Edmonston	221/63
D171,955	S *	4/1954	Robins	D9/721
3,145,840	A *	8/1964	Wright	206/494
3,239,097	A *	3/1966	Bates et al.	221/48
3,424,367	A *	1/1969	Lesinski et al.	229/118
4,997,105	A *	3/1991	Fischer	221/45
D328,992	S *	9/1992	Hollinger	D6/518
D353,091	S *	12/1994	Mumford	D9/761
5,379,897	A *	1/1995	Muckenfuhs et al.	206/494
5,542,598	A *	8/1996	Capo	229/242
5,556,026	A *	9/1996	Blankitny	229/123.1
5,816,440	A *	10/1998	Shields et al.	221/45
D504,314	S *	4/2005	Kim	D9/416
7,063,233	B2 *	6/2006	Jordan et al.	221/197
D568,763	S *	5/2008	Keberlein	D9/734

7,565,976	B2 *	7/2009	Nakamura et al.	206/494
D608,660	S *	1/2010	Mau	D9/734
2002/0175094	A1 *	11/2002	Campbell et al.	206/233

(Continued)

*Primary Examiner* — Derrick Holland

*Assistant Examiner* — Lauren Calve

(74) *Attorney, Agent, or Firm* — McAndrews, Held & Malloy, Ltd.

(57) **CLAIM**

The ornamental design for packaging for sanitation gloves, as shown and described.

**DESCRIPTION**

FIG. 1 is a front perspective view of packaging for sanitation gloves showing a first embodiment of my new design; FIG. 2 is a front perspective view thereof with the unclaimed hand and glove depictions removed; FIG. 3 is a front elevation view thereof; FIG. 4 is a rear elevation view thereof; FIG. 5 is a right side elevation view thereof; FIG. 6 is a left side elevation view thereof; FIG. 7 is a top plan view thereof; FIG. 8 is a bottom plan view thereof; FIG. 9 is a front perspective view of packaging for sanitation gloves showing a second embodiment of my new design; FIG. 10 is a front elevation view thereof; FIG. 11 is a rear elevation view thereof; FIG. 12 is a right side elevation view thereof; FIG. 13 is a left side elevation view thereof; FIG. 14 is a top plan view thereof; and, FIG. 15 is a bottom plan view thereof.

The hand and glove depictions shown in broken lines represent environment in which the design is used and form no part of the claimed design.

The dotted lines shown in FIGS. 9 and 14 represent claimed perforations. The surface stippling represents a contrast of color.

**1 Claim, 9 Drawing Sheets**

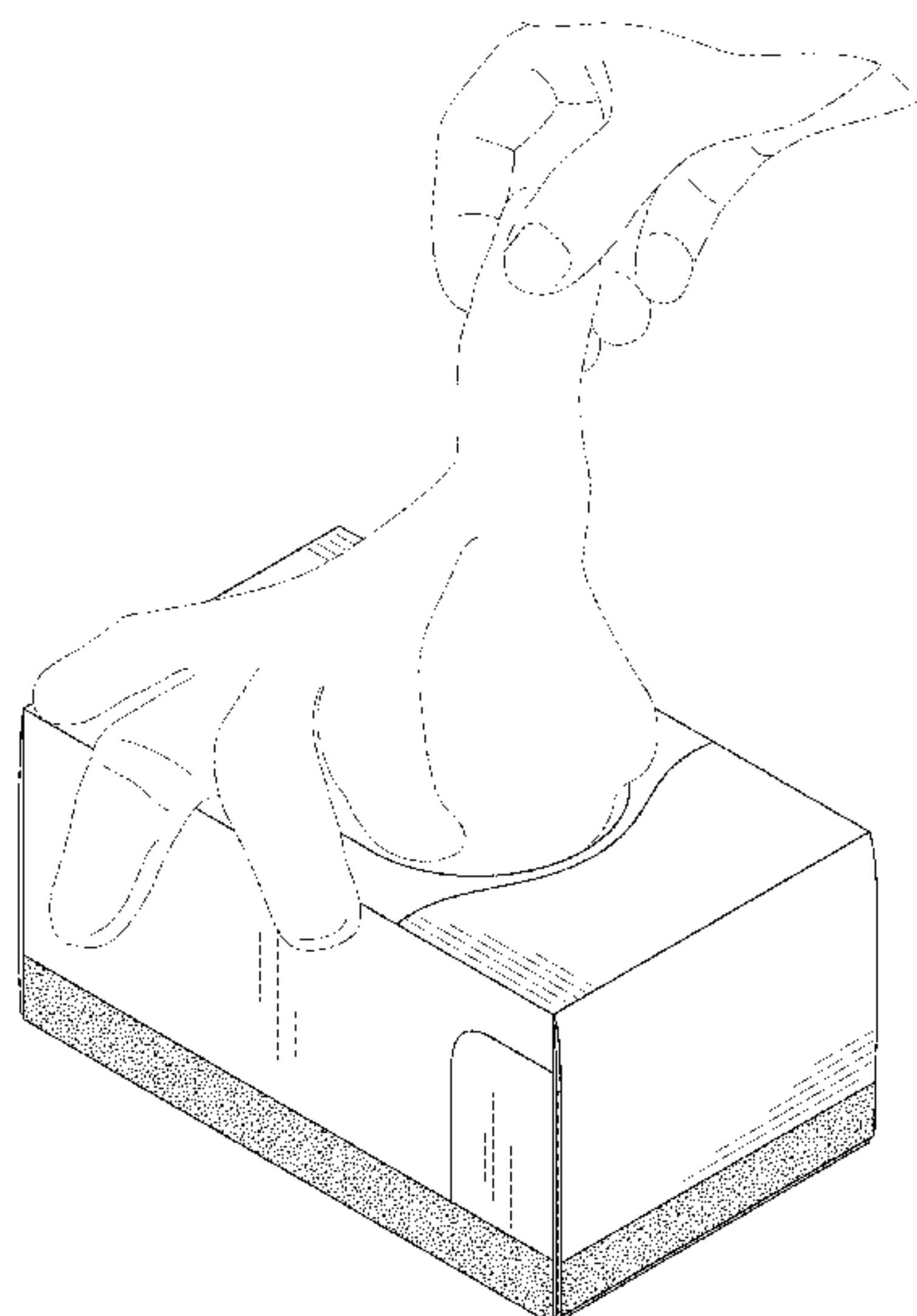

# US D683,245 S

Page 2

---

## U.S. PATENT DOCUMENTS

2005/0011906	A1*	1/2005	Buck et al. ....	221/64	2010/0270325	A1*	10/2010	Fearon .....	221/45
2005/0150788	A1*	7/2005	Feusner .....	206/278	2011/0215110	A1*	9/2011	Kadhun et al. ....	221/45
2009/0261001	A1*	10/2009	Yao et al. ....	206/223					

\* cited by examiner

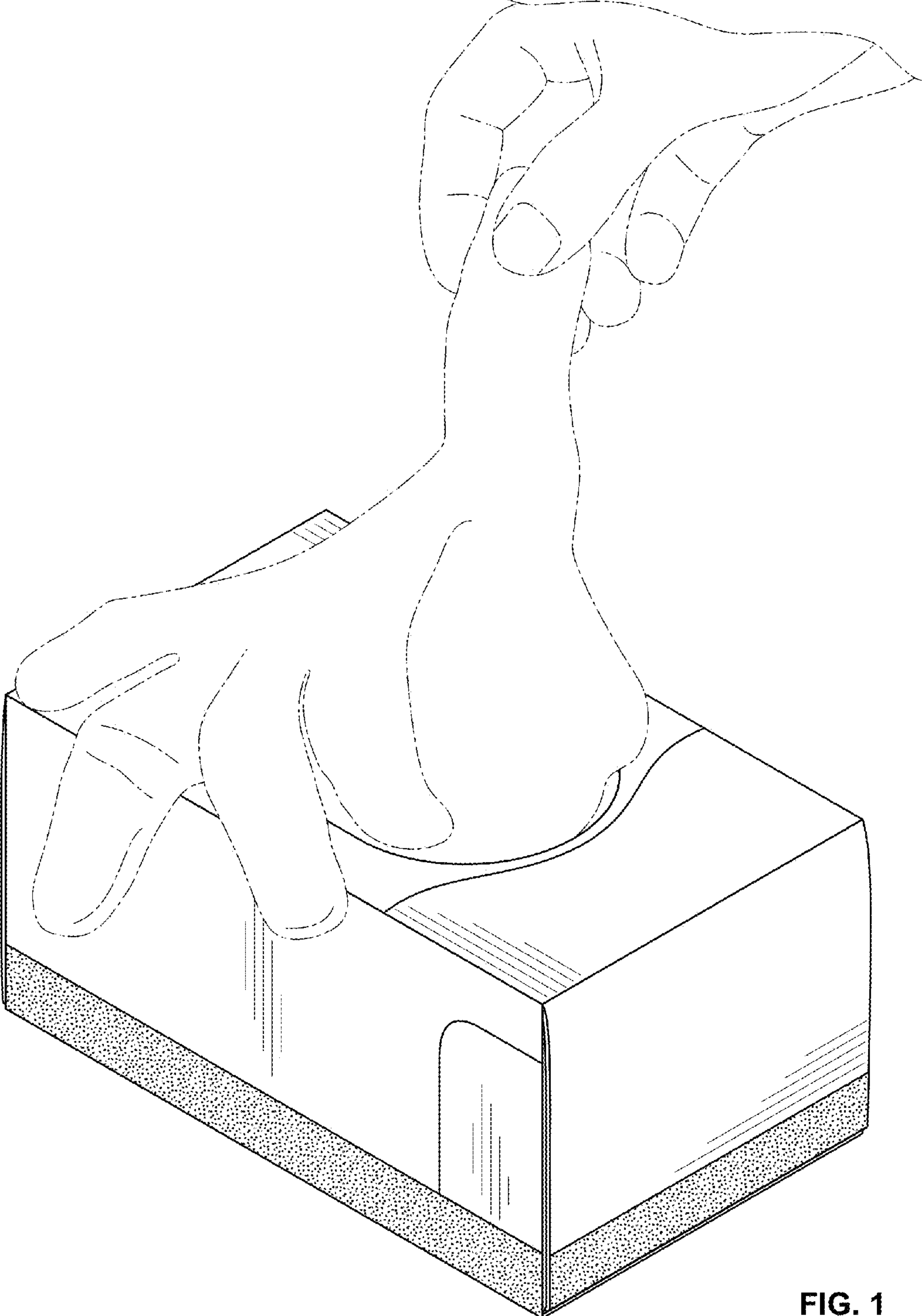

FIG. 1

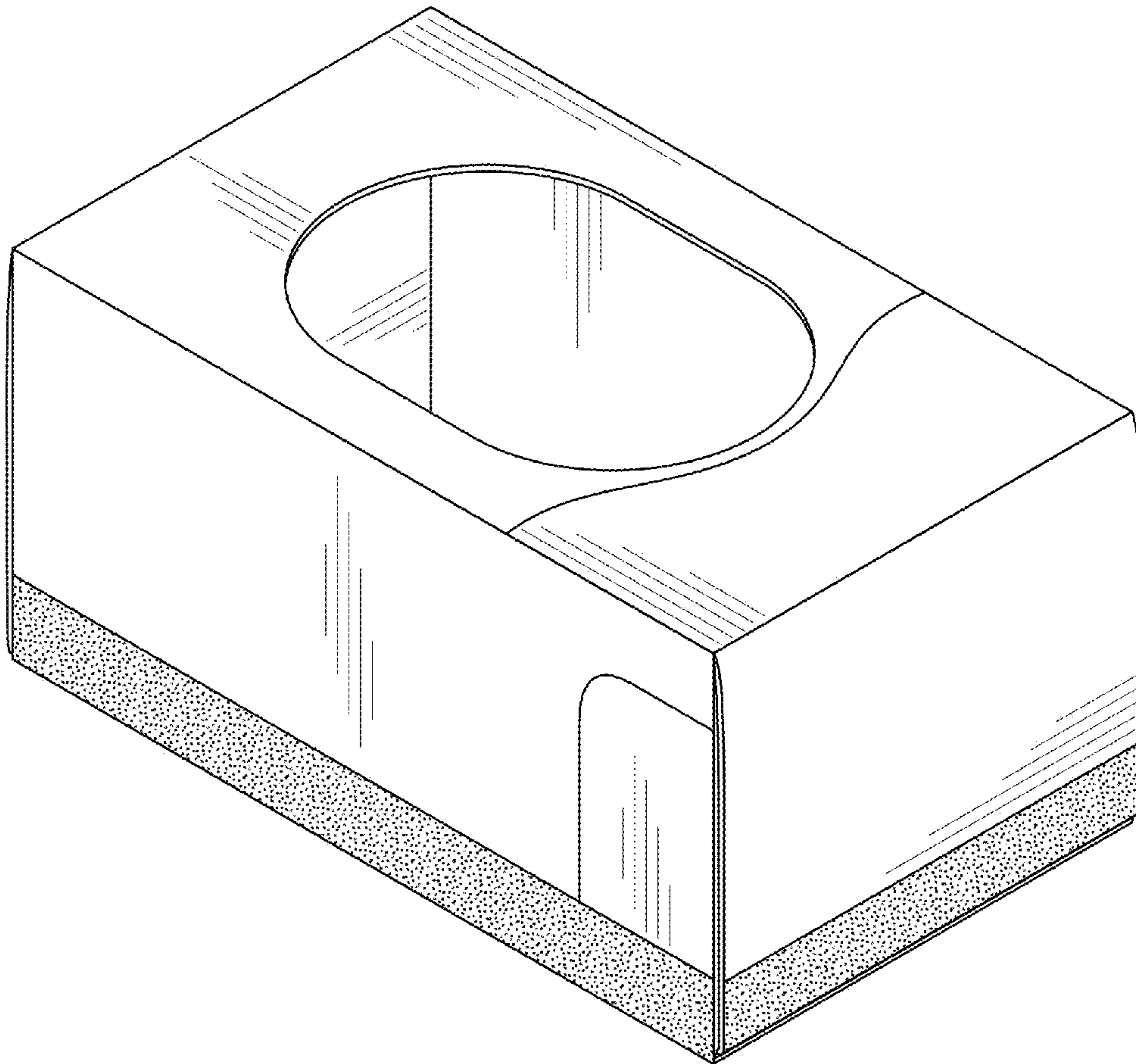

FIG. 2



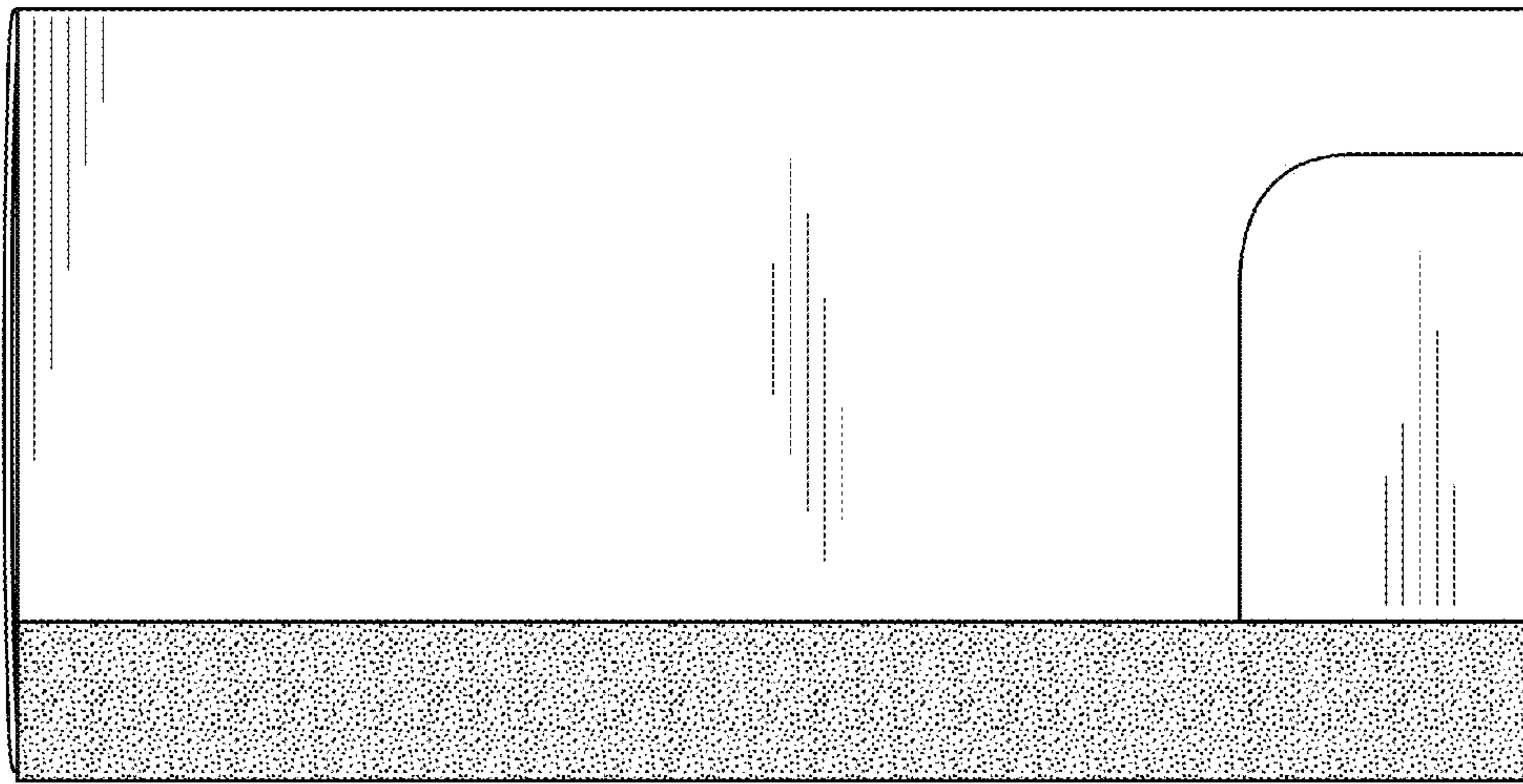

FIG. 3

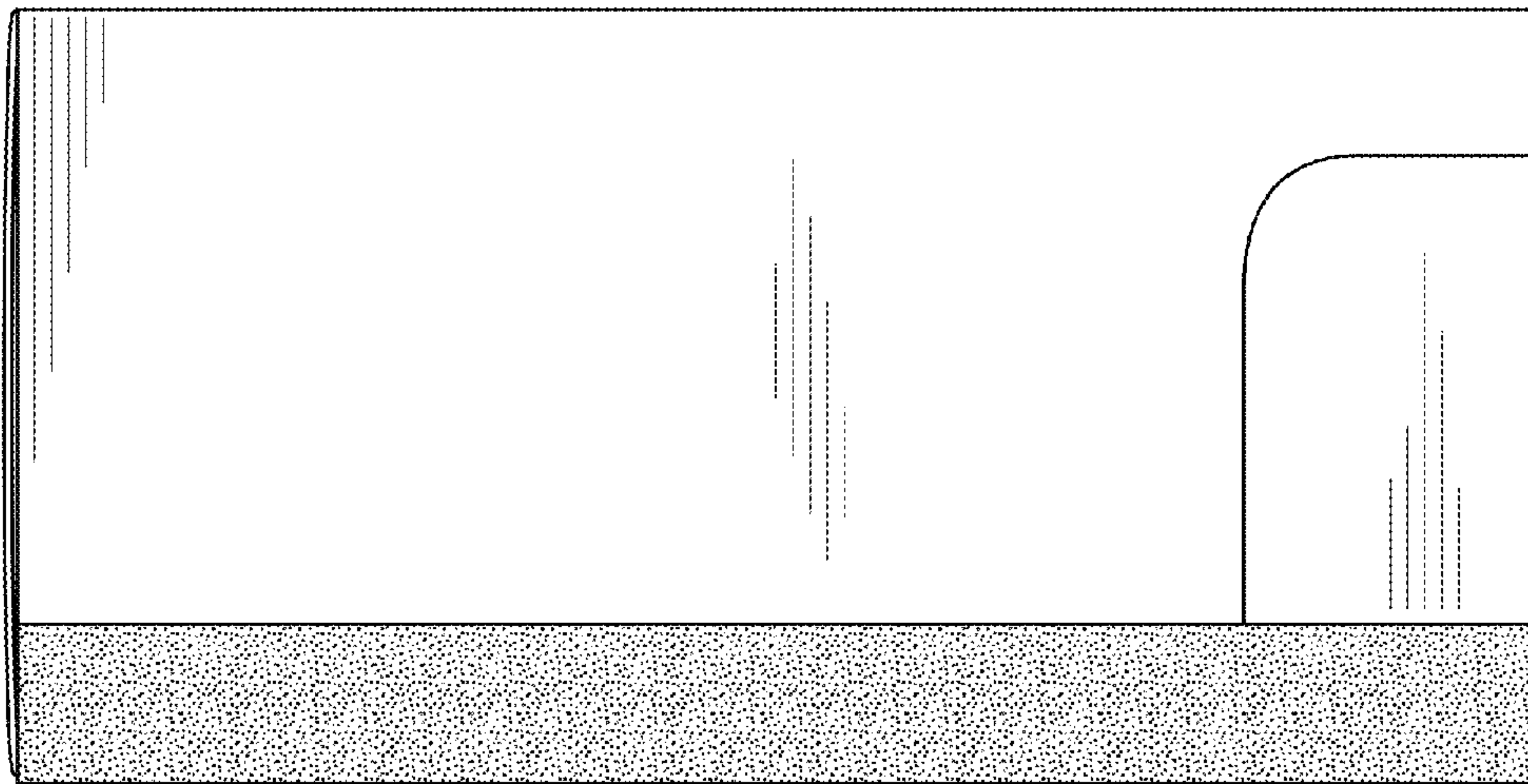

FIG. 4

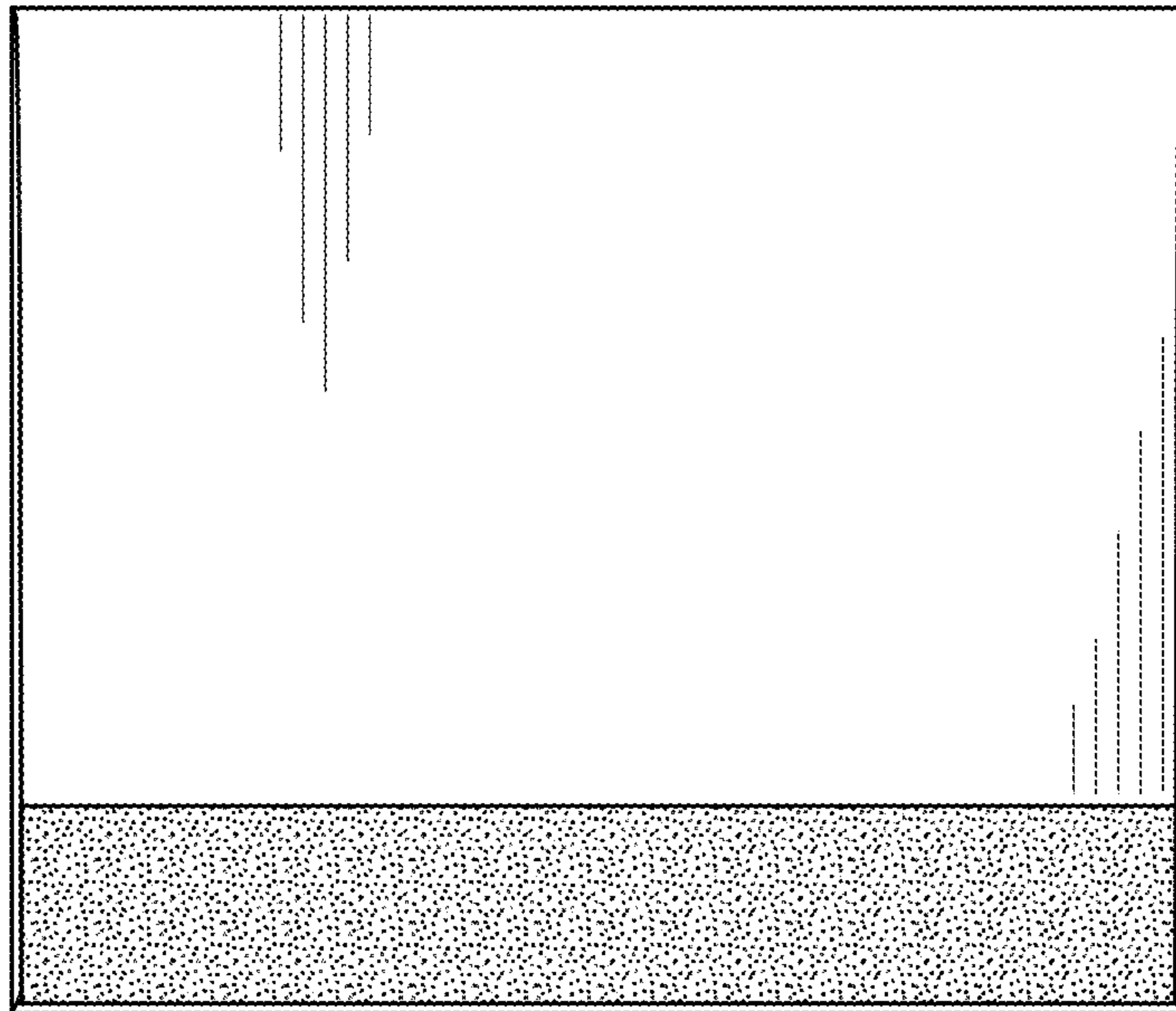

FIG. 5

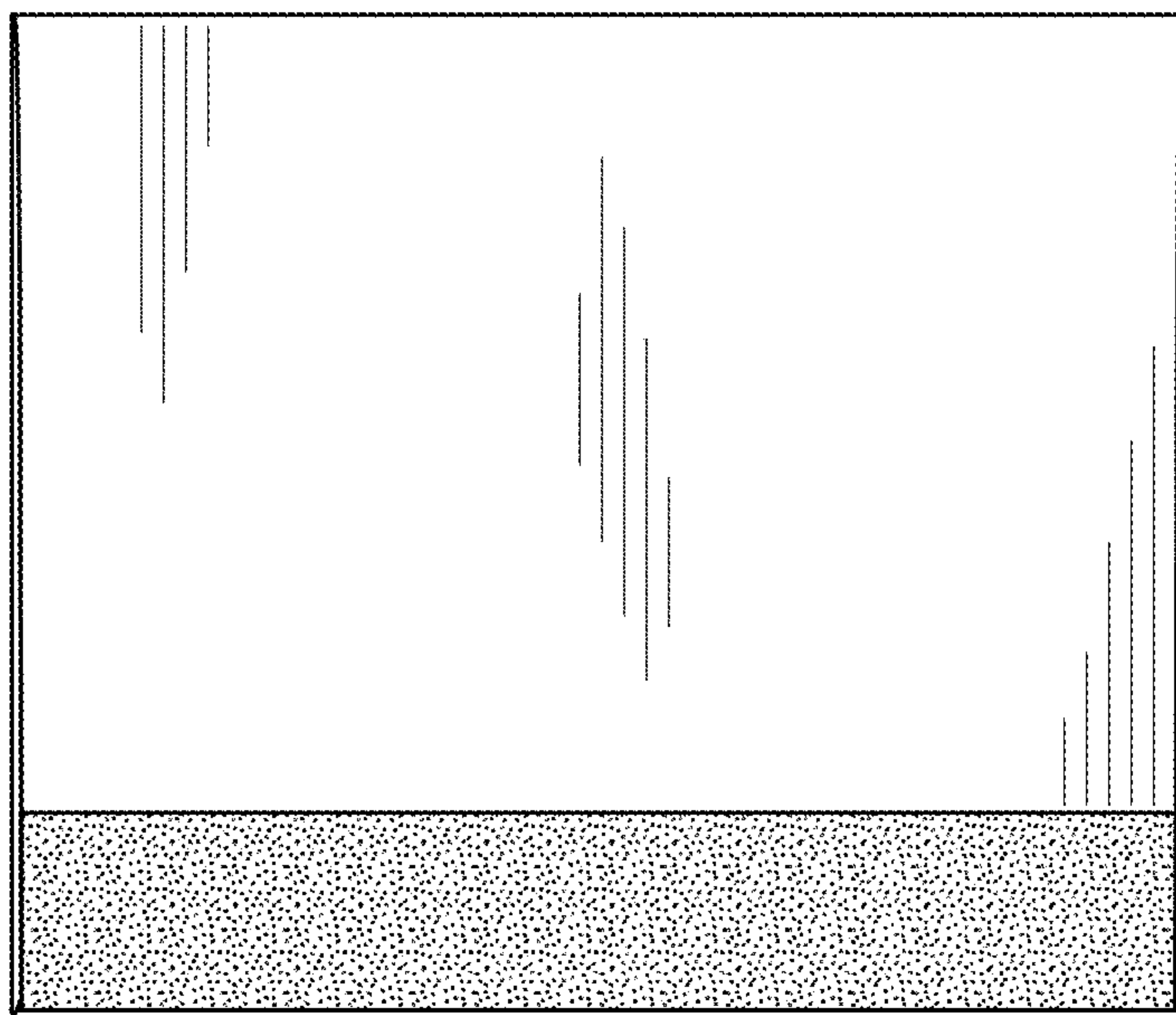

FIG. 6

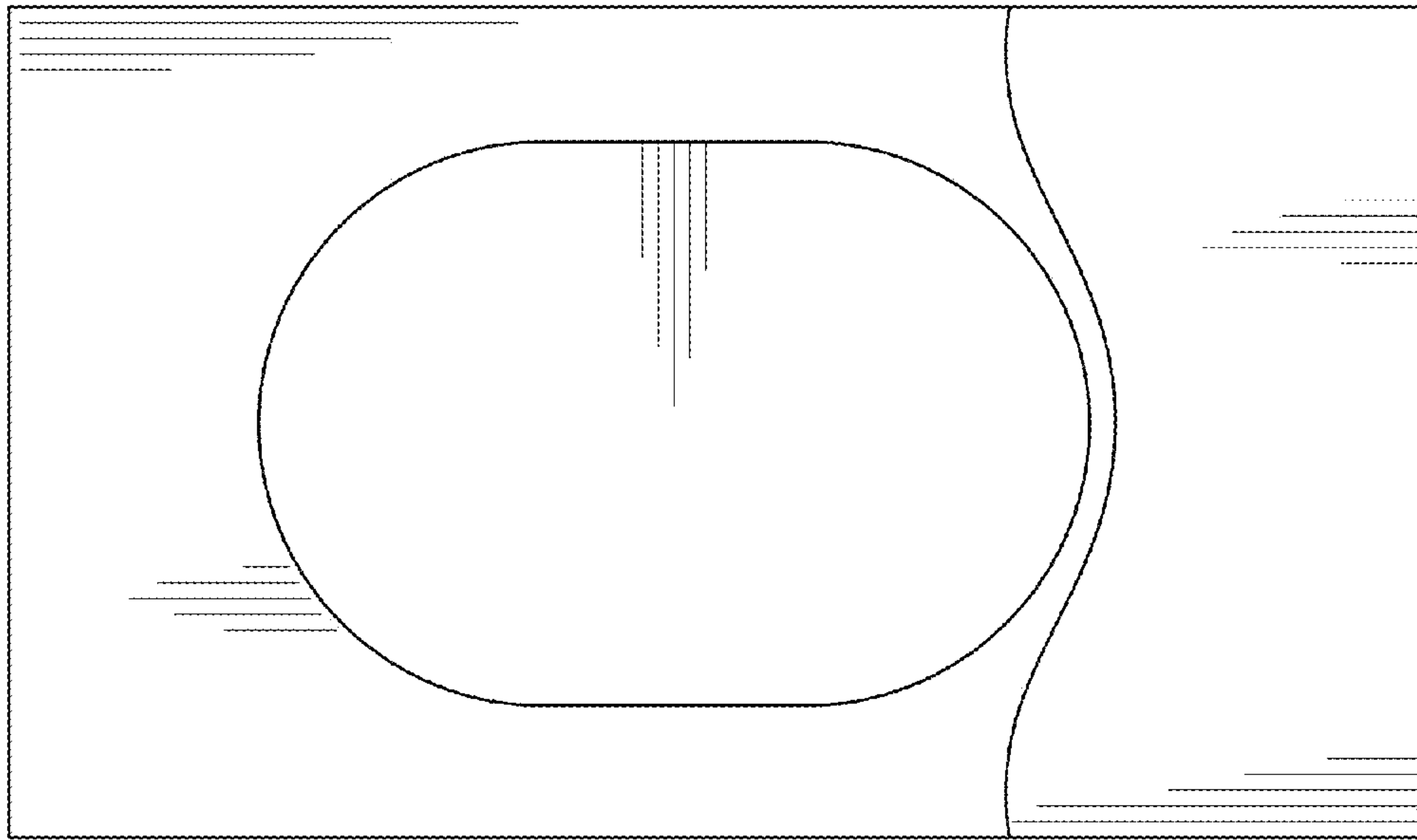

FIG. 7

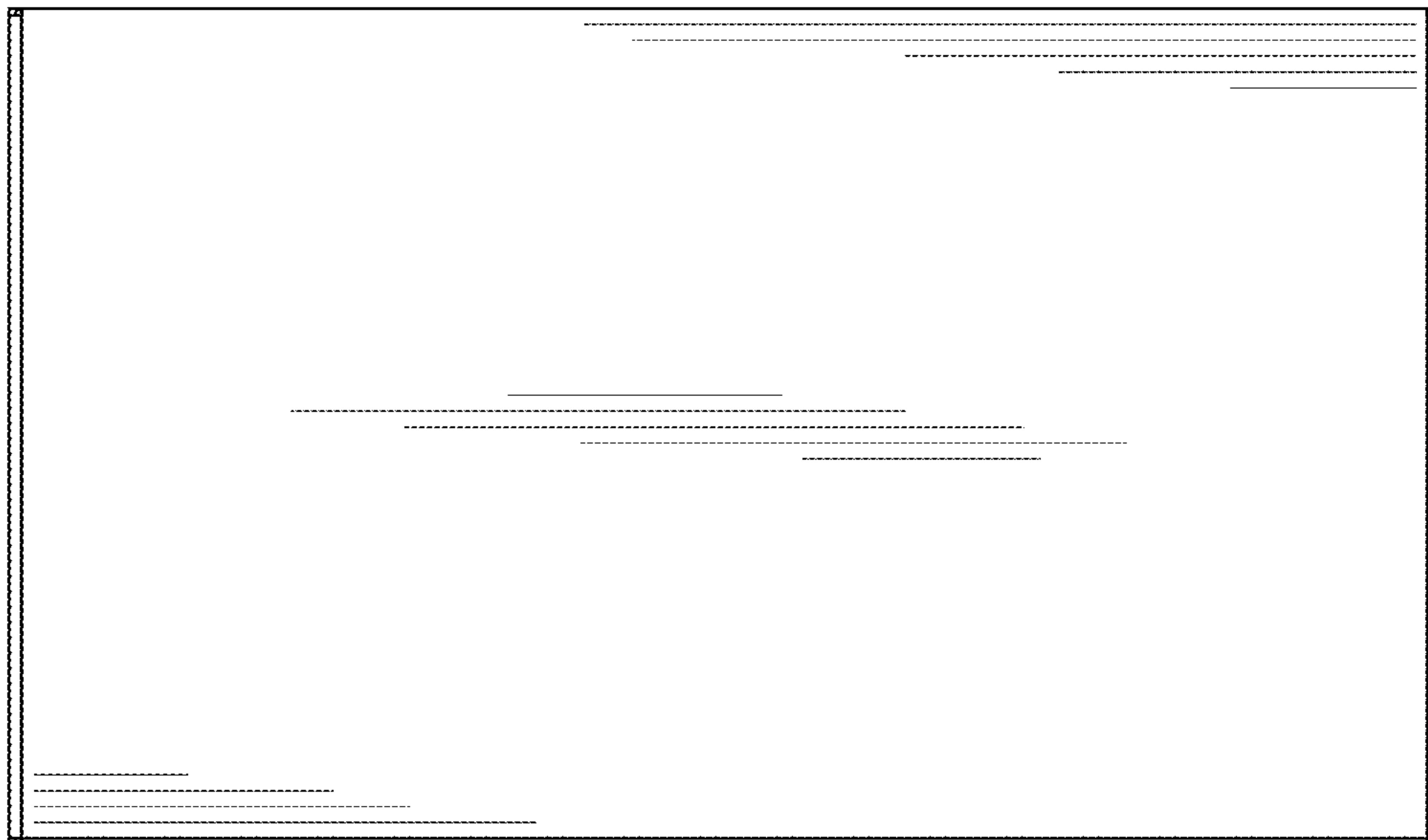

FIG. 8

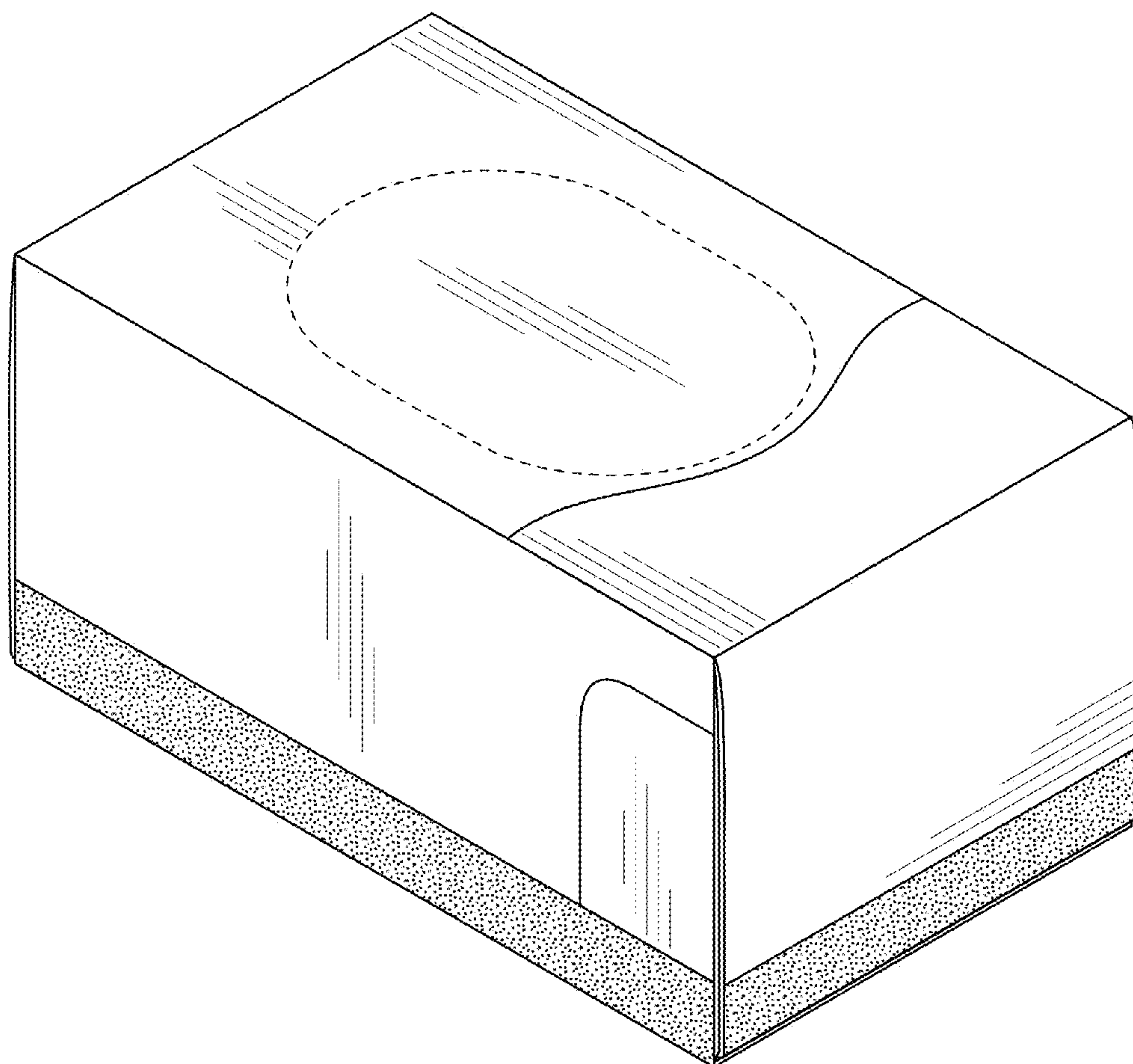

FIG. 9



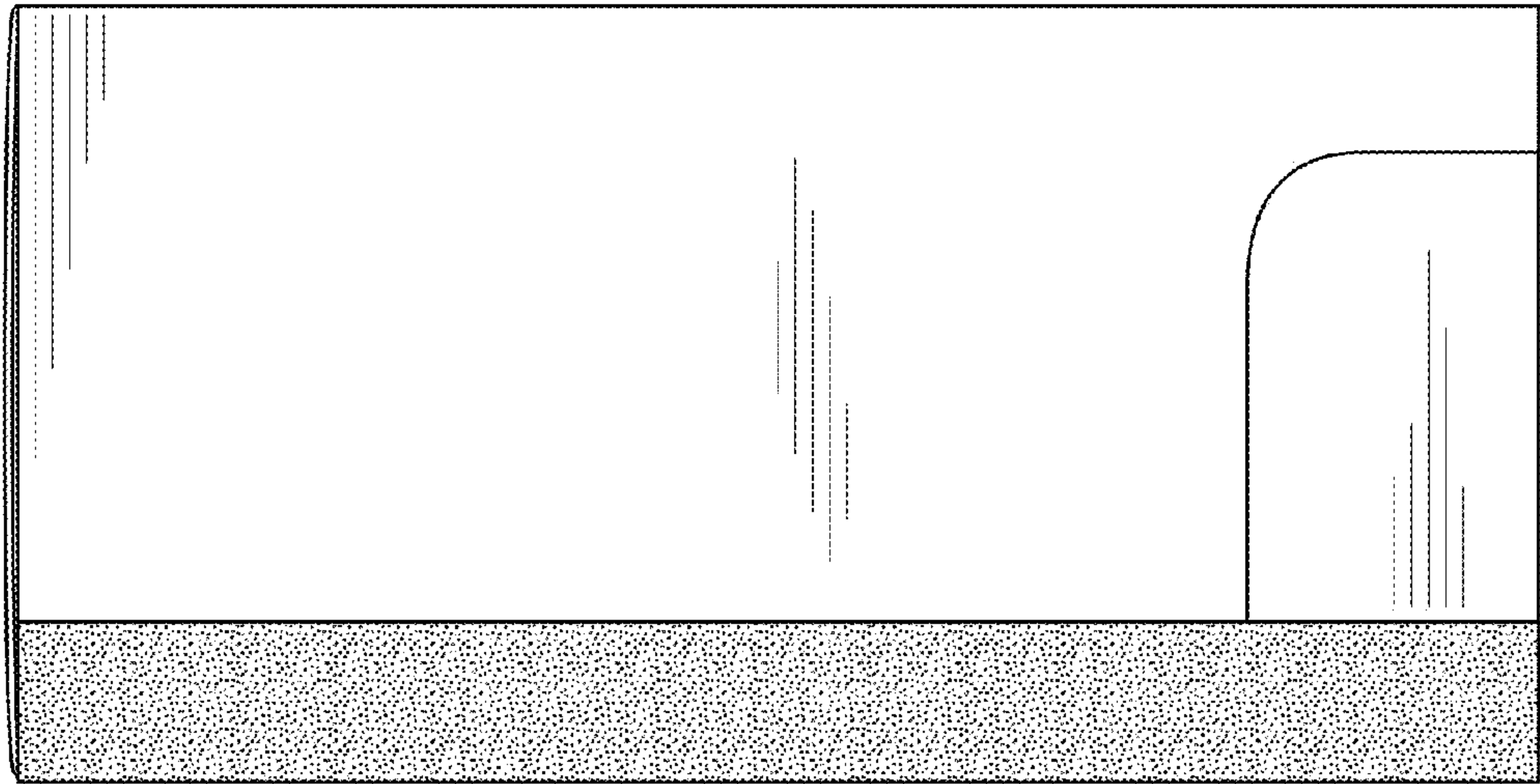

FIG. 10

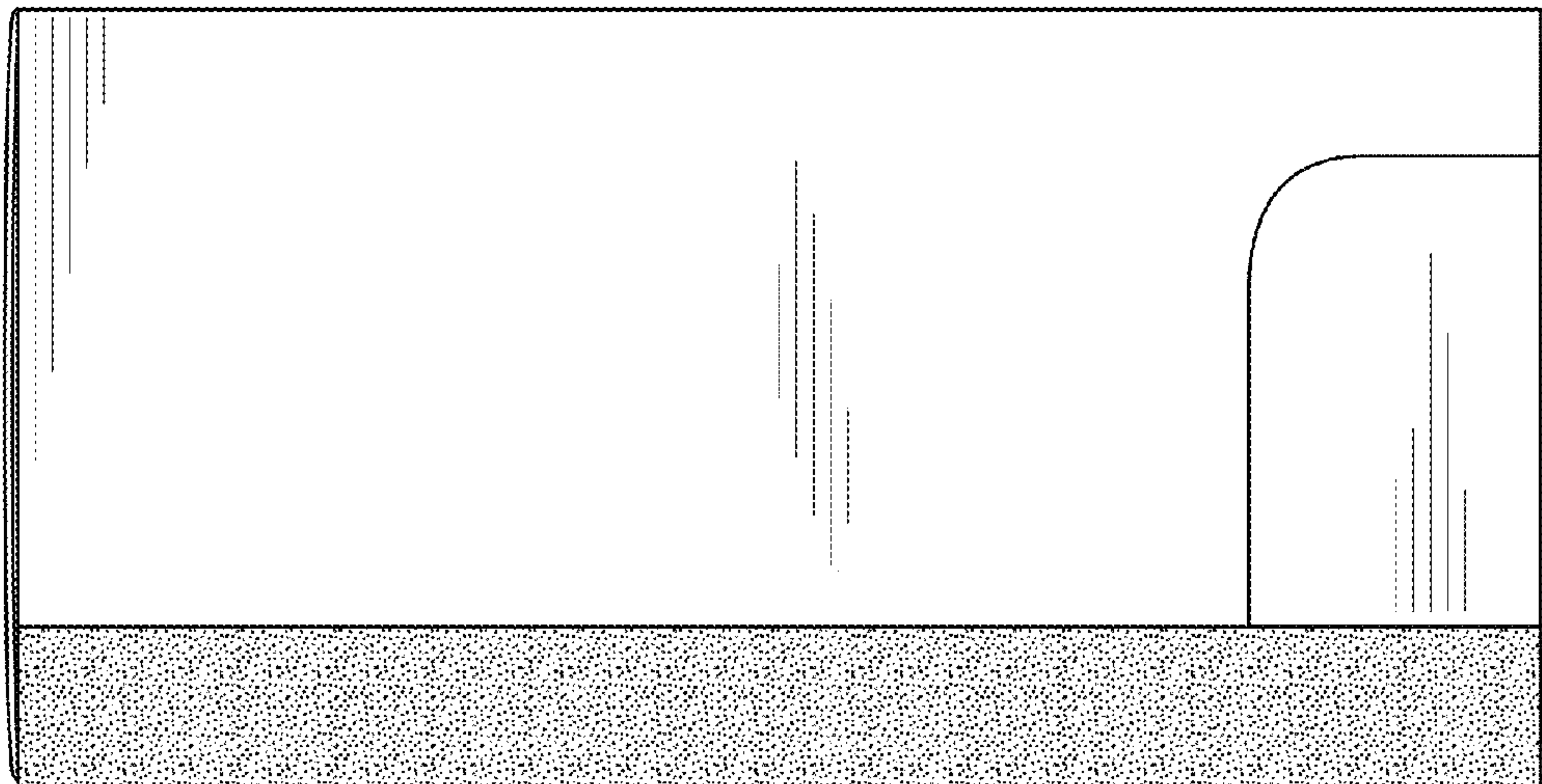

FIG. 11

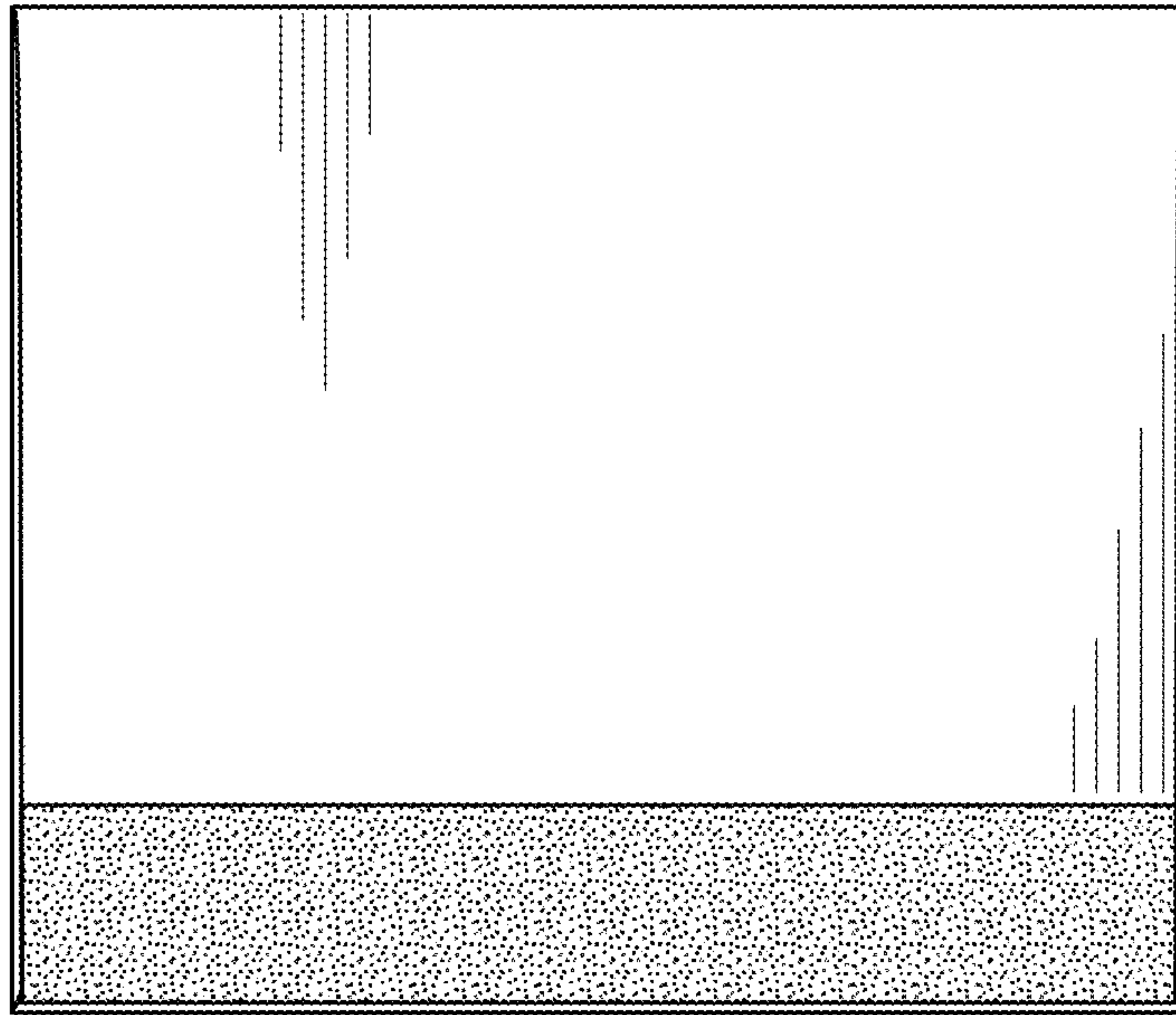

FIG. 12

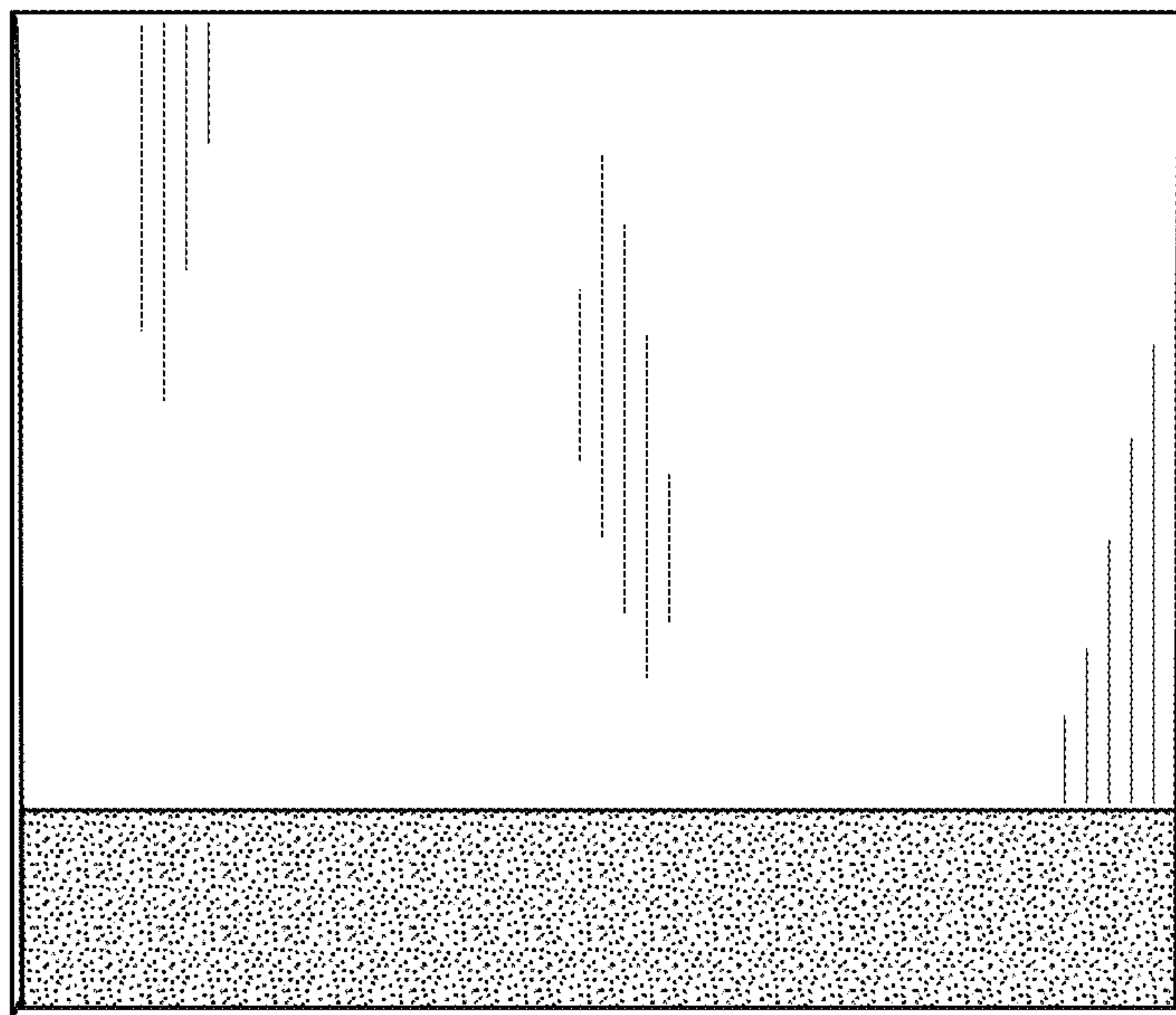

FIG. 13

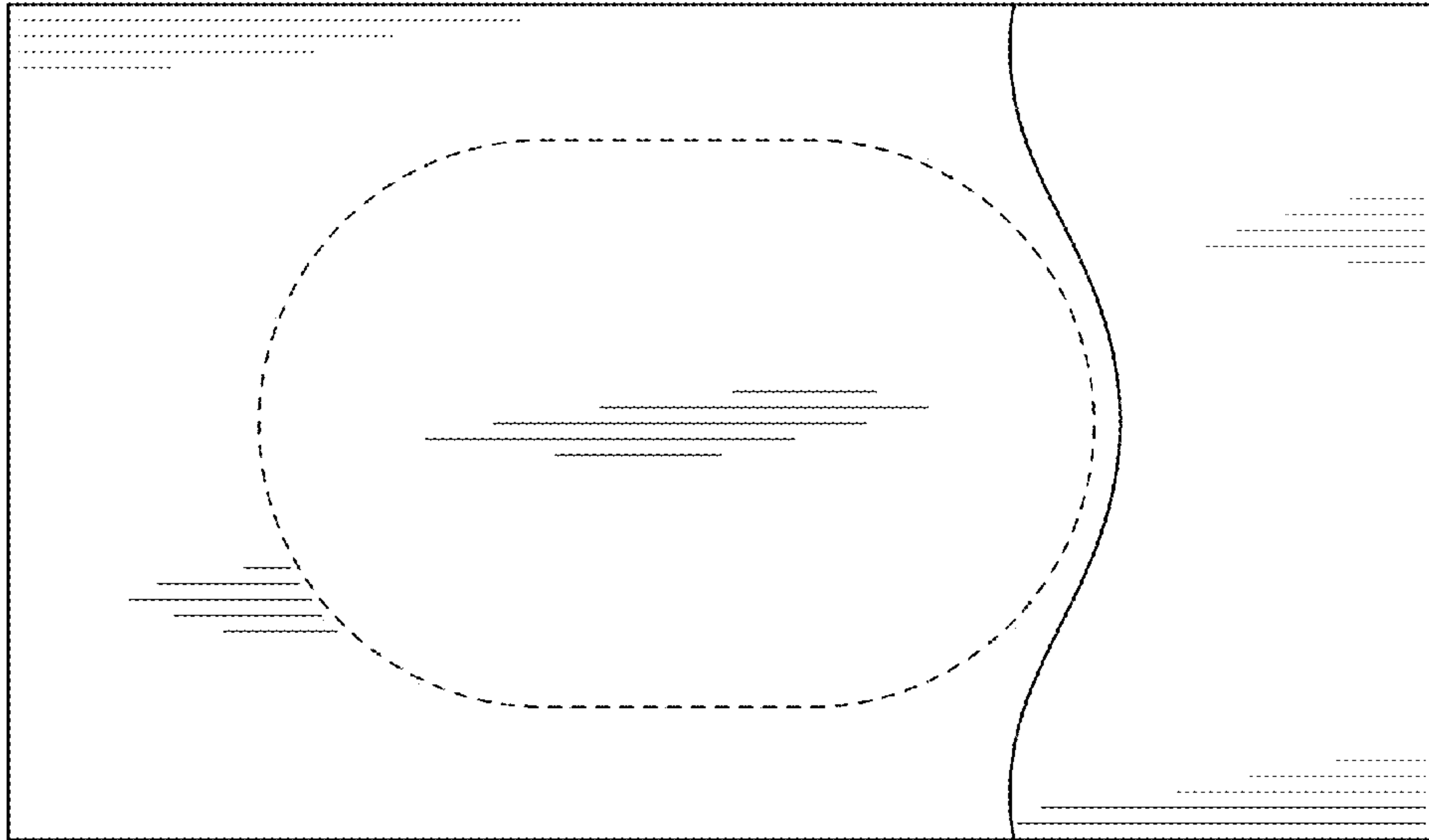

FIG. 14

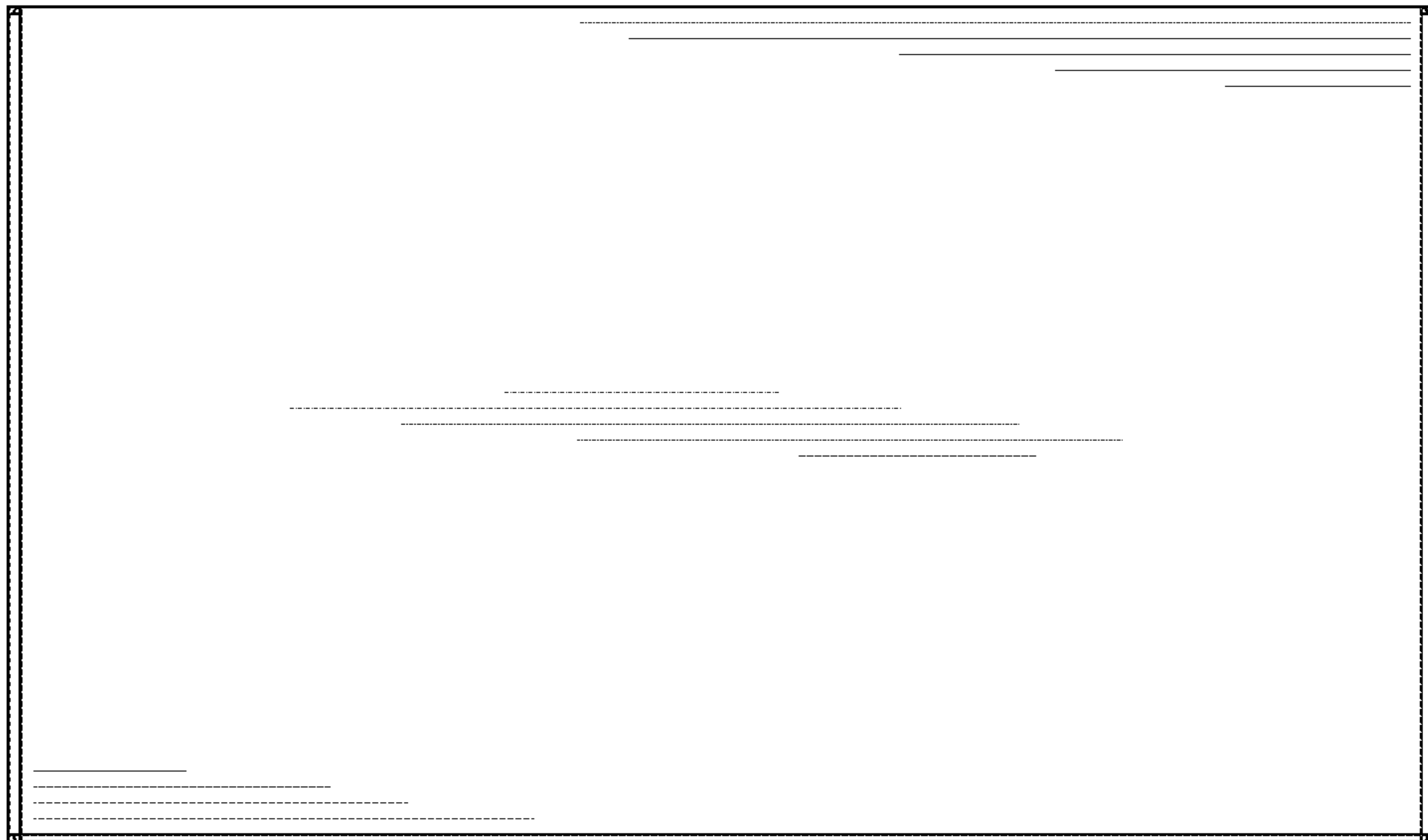

FIG. 15