



US00D683161S

(12) **United States Design Patent**
Polloni et al.

(10) **Patent No.:** **US D683,161 S**

(45) **Date of Patent:** **** May 28, 2013**

(54) **TABLE**

(75) Inventors: **Piergiorgio Polloni**, Treviso (IT); **Paolo Cortivo**, Treviso (IT); **Stefano Gabriel**, Treviso (IT)

(73) Assignee: **Quadrifoglio Sistemi d'Arredo S.p.A.**, Mansue, Frazione Basalghelle (IT)

(**) Term: **14 Years**

(21) Appl. No.: **29/418,867**

(22) Filed: **Apr. 23, 2012**

(30) **Foreign Application Priority Data**

Oct. 24, 2011 (EM) 001936782

(51) **LOC (9) Cl.** **06-03**

(52) **U.S. Cl.**
USPC **D6/484**

(58) **Field of Classification Search** D6/480-489,
D6/495, 496, 499, 498, 681.1, 709.21, 708.23,
D6/366; 108/150, 153.1, 155, 157, 161; 248/188,
248/188.8, 188.7
See application file for complete search history.

(56) **References Cited**

U.S. PATENT DOCUMENTS

D487,654 S * 3/2004 Molteni D6/484
D663,133 S * 7/2012 Pelikan D6/429
D668,479 S * 10/2012 Henriott et al. D6/495

* cited by examiner

Primary Examiner — Janice Seeger

(74) *Attorney, Agent, or Firm* — Foley & Lardner LLP

(57) **CLAIM**

The ornamental design for a table, as shown.

DESCRIPTION

FIG. 1 is a perspective view of the table;
FIG. 2 is a front view thereof;
FIG. 3 is a left side view thereof;
FIG. 4 is a bottom view thereof;
FIG. 5 is a view of a detail thereof;
FIG. 6 is a view of a further detail thereof;
FIG. 7 is a view of a further detail thereof;
FIG. 8 is a rear view thereof;
FIG. 9 is a right side view thereof;
FIG. 10 is a top view thereof;
FIG. 11 is a perspective view of the table with the top removed;
FIG. 12 is a front view thereof;
FIG. 13 is a left side view thereof;
FIG. 14 is a bottom view thereof;
FIG. 15 is a top view of a detail thereof;
FIG. 16 is a top view of a further detail thereof;
FIG. 17 is a top view of a further detail thereof;
FIG. 18 is a rear view thereof; and,
FIG. 19 is a right side view thereof.
The table top is shown removed in FIGS. 11-19 for clarity of disclosure.
The broken lines on the bottom of the feet and table top are for environmental purposes only and form no part of the claimed design.

1 Claim, 19 Drawing Sheets

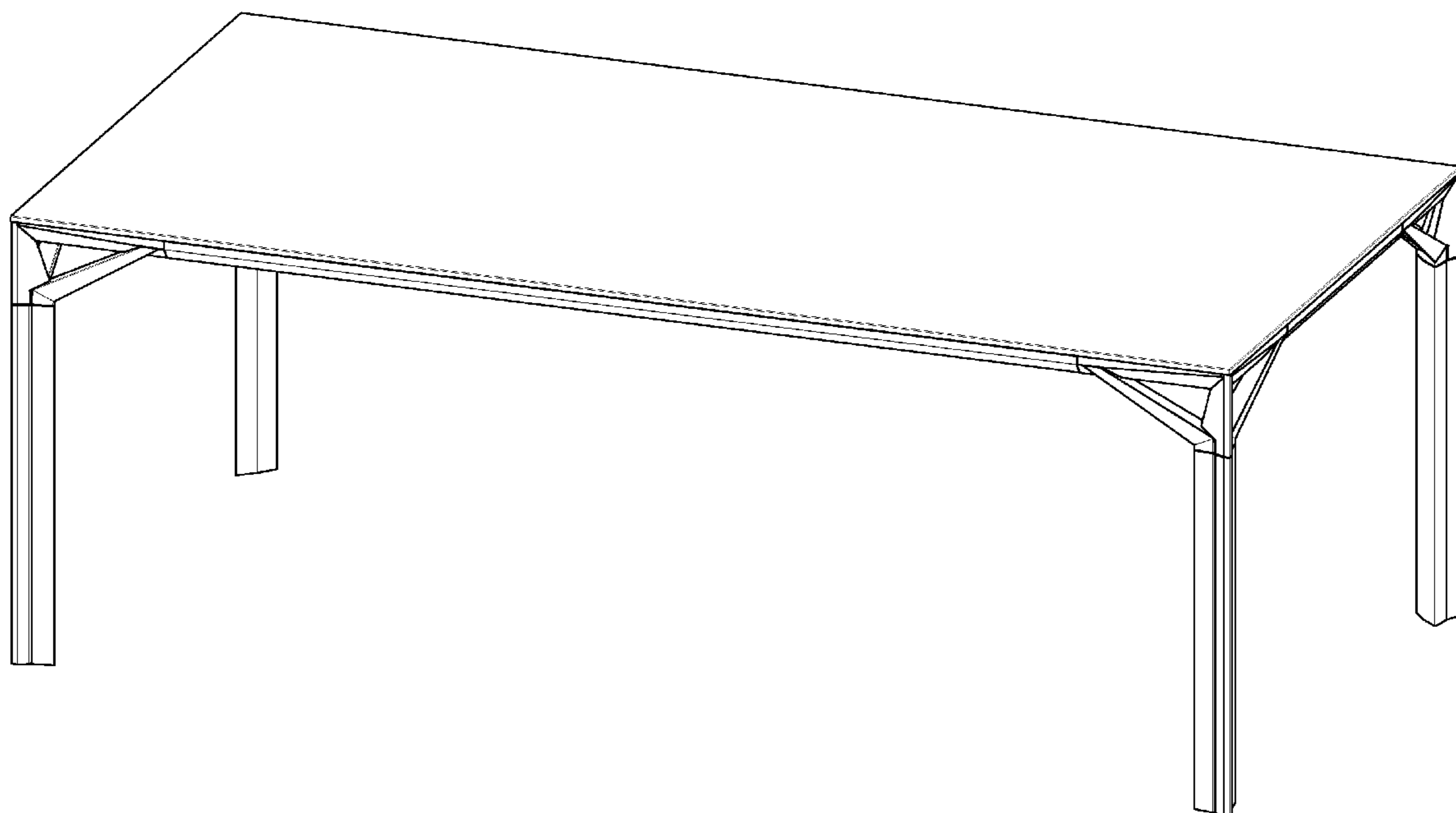

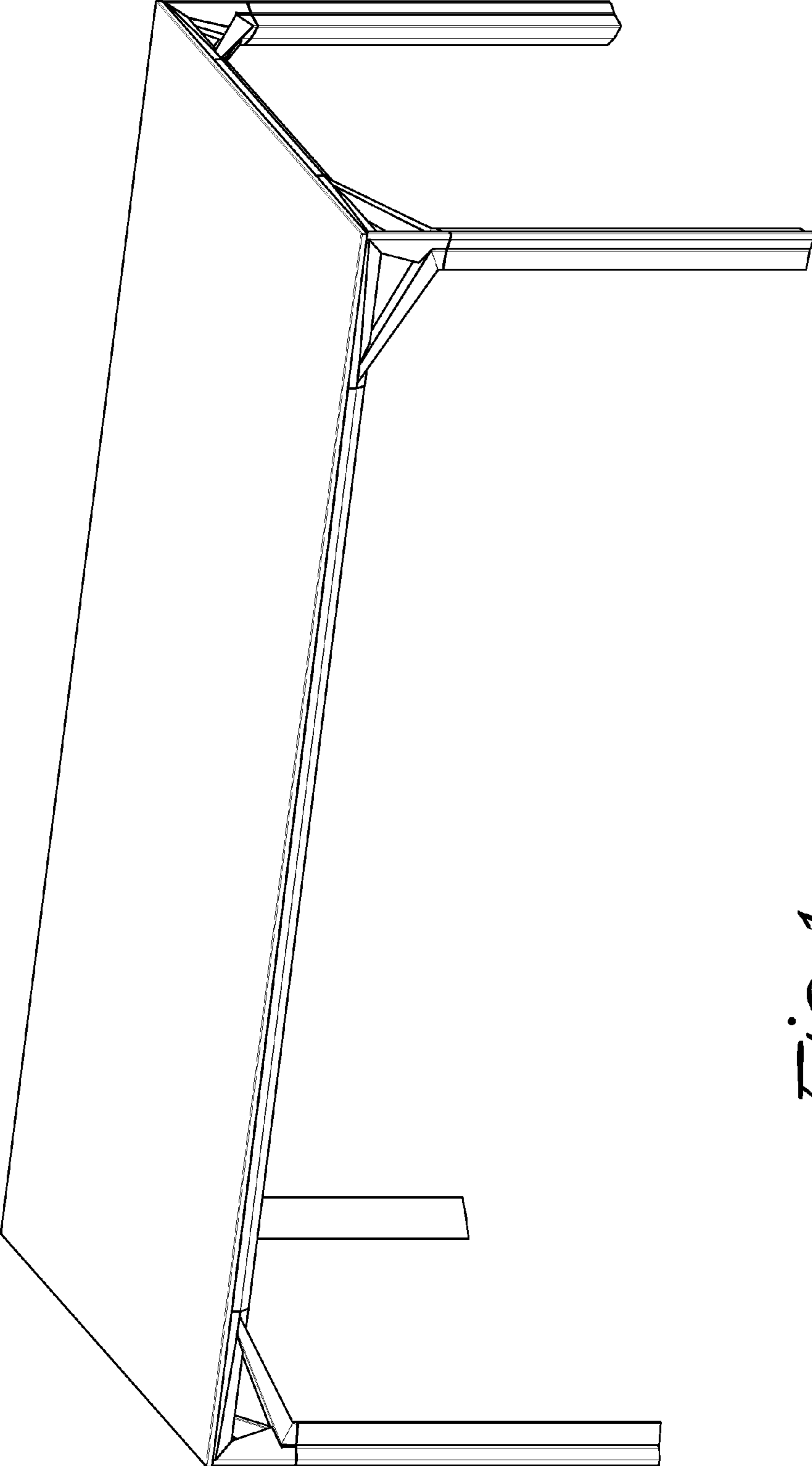

Fig. 1

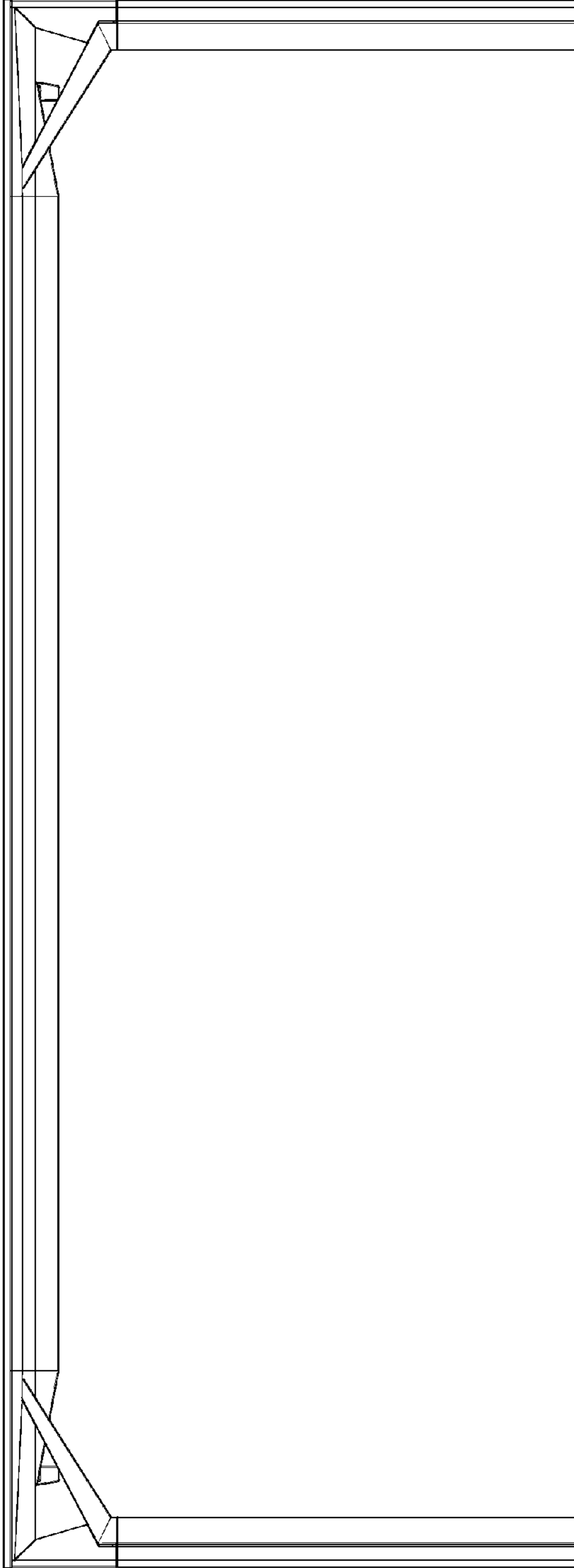

Fig. 2

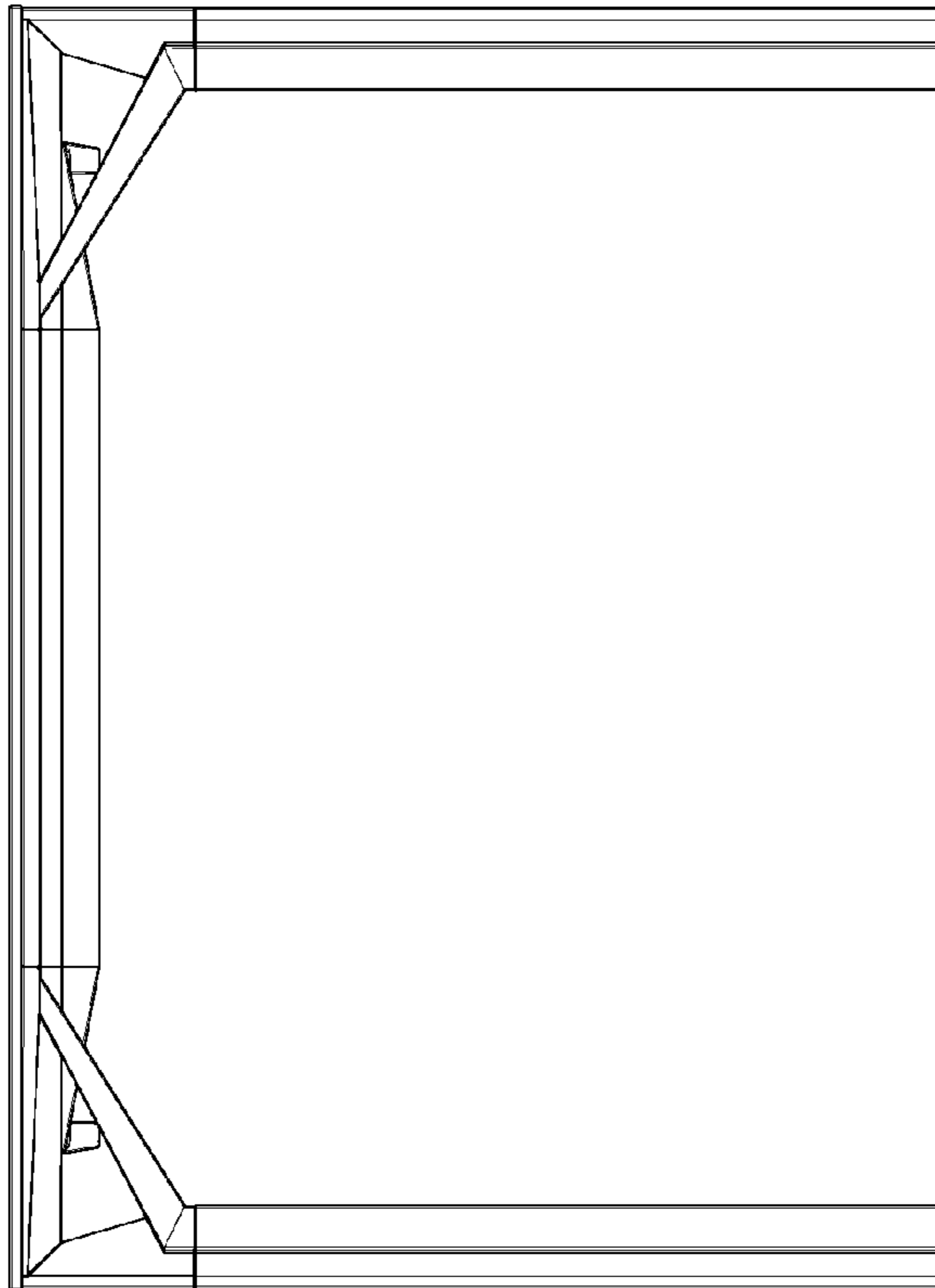

Fig. 3

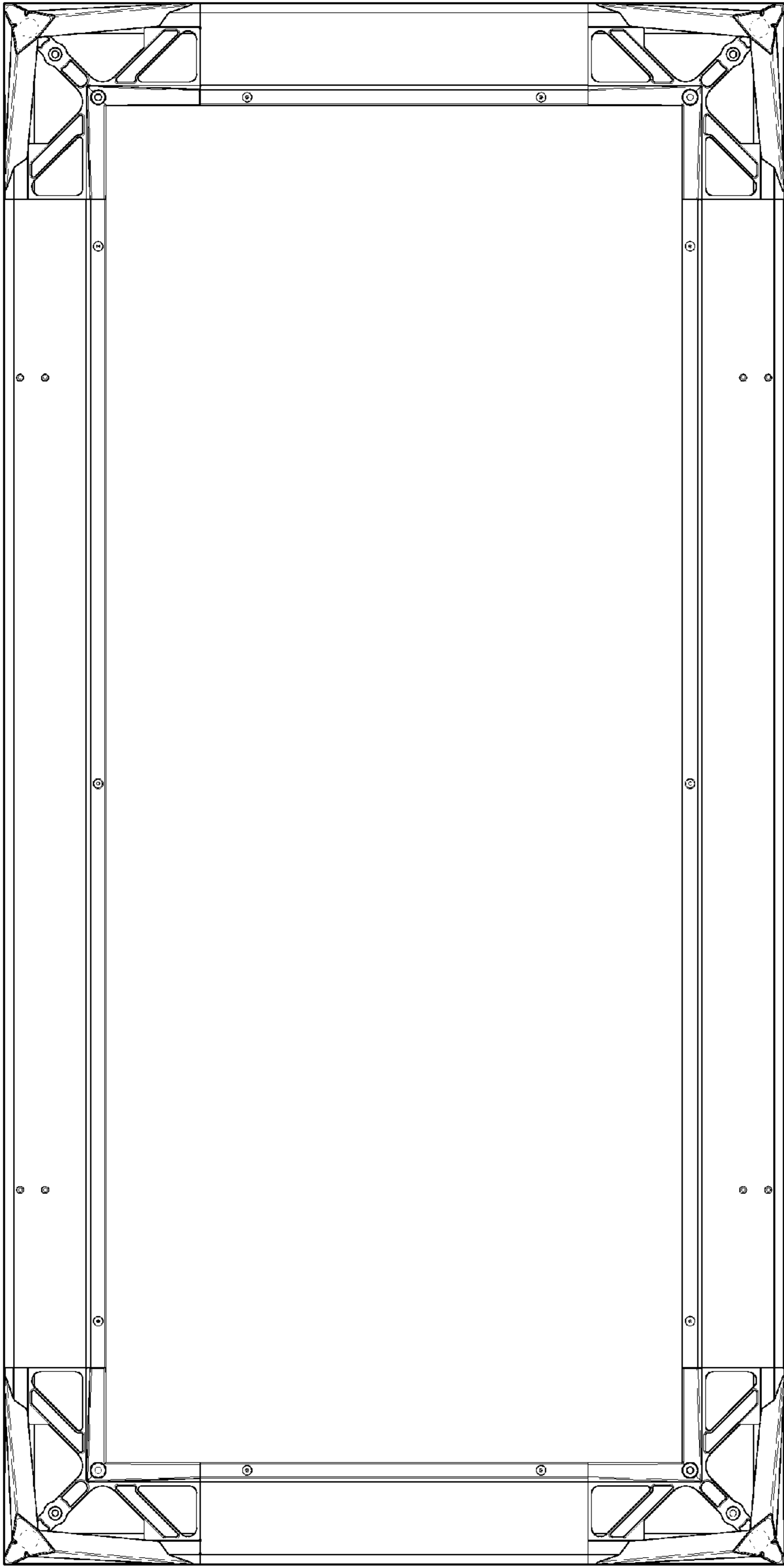

Fig. 4

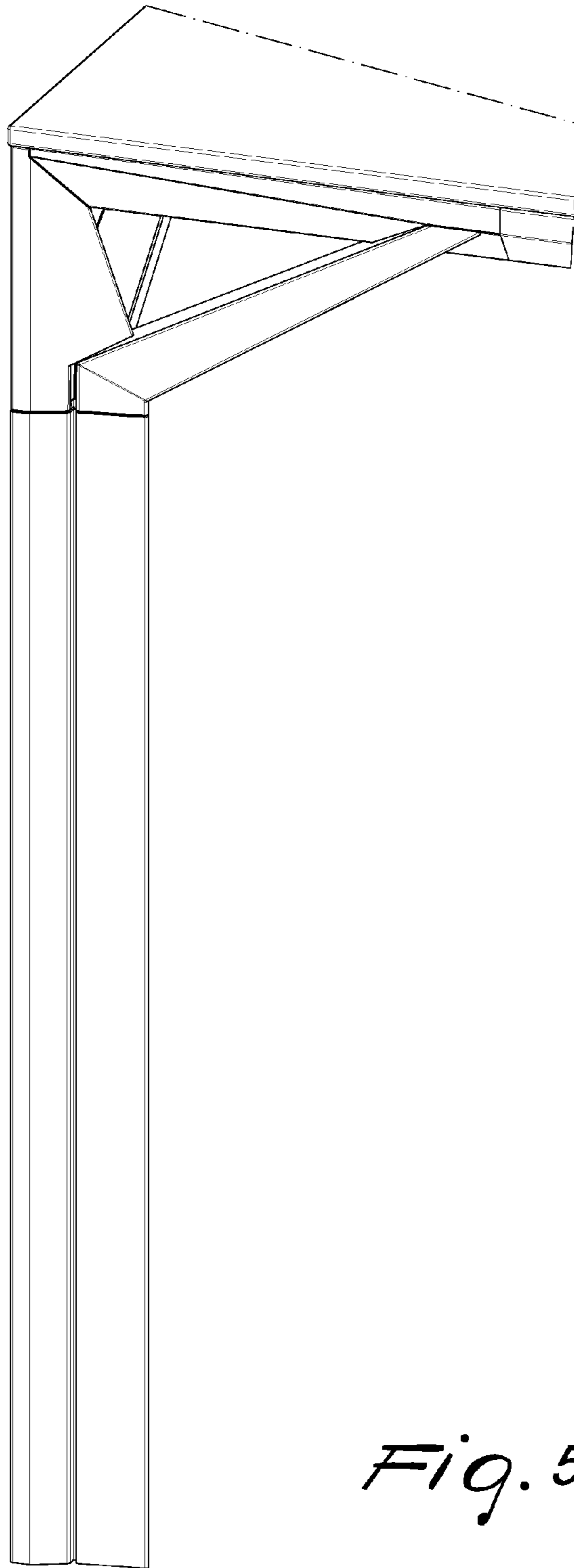

Fig. 5

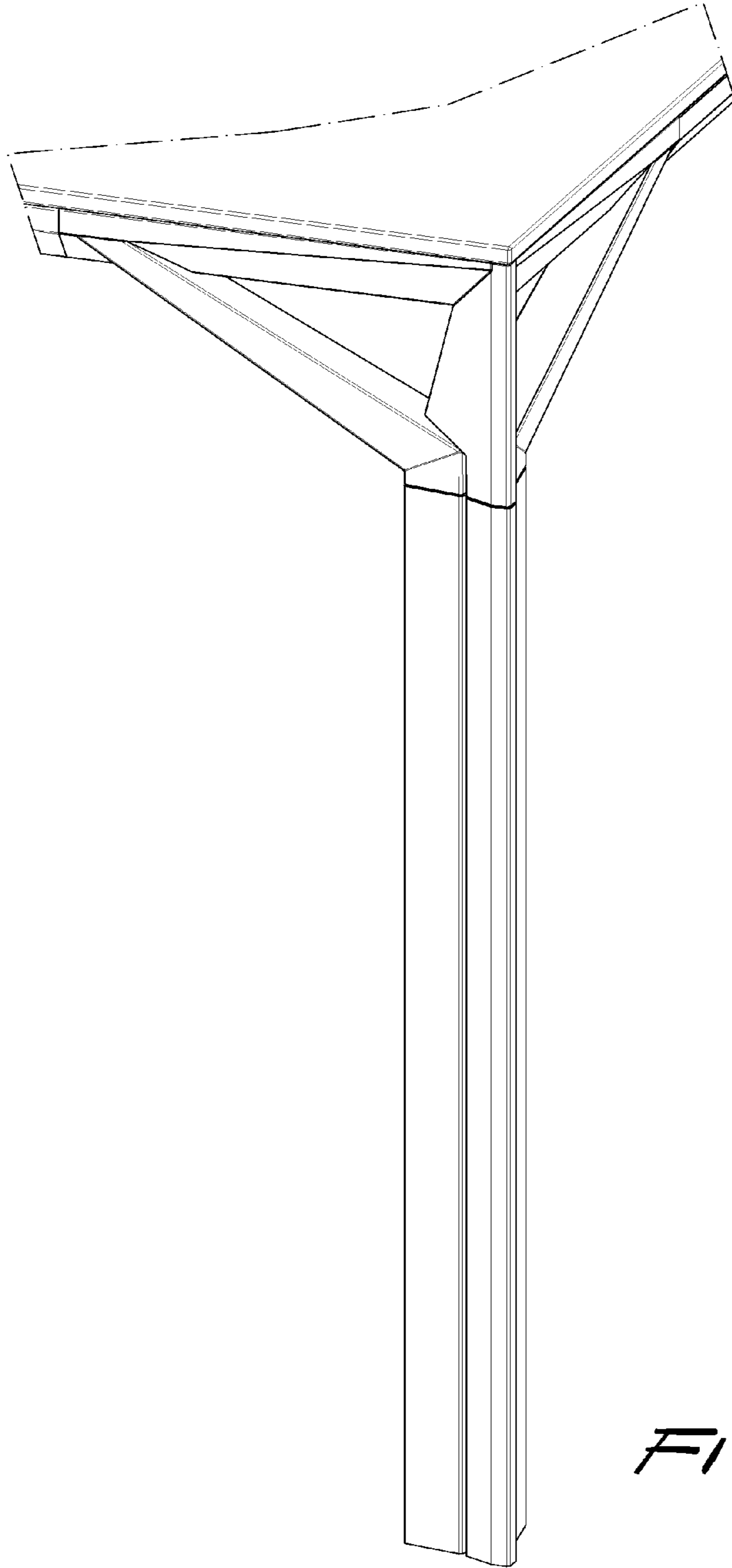

Fig. 6

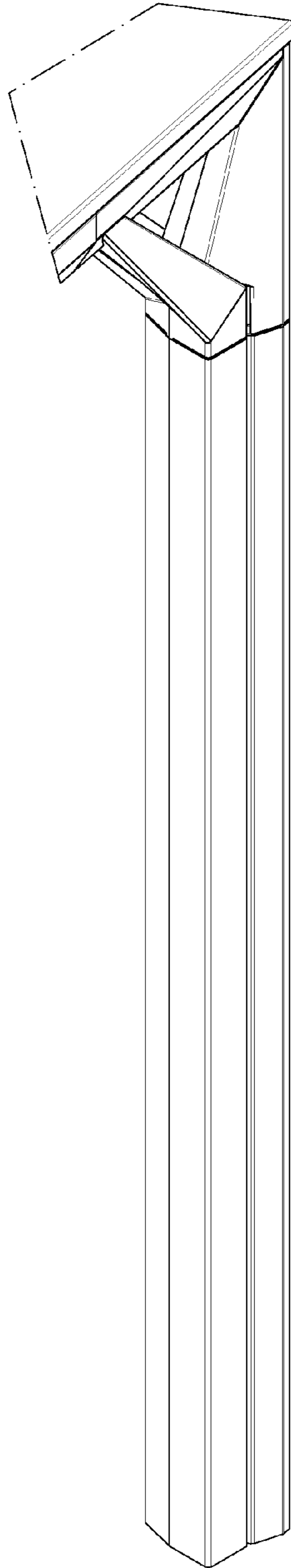

Fig. 7

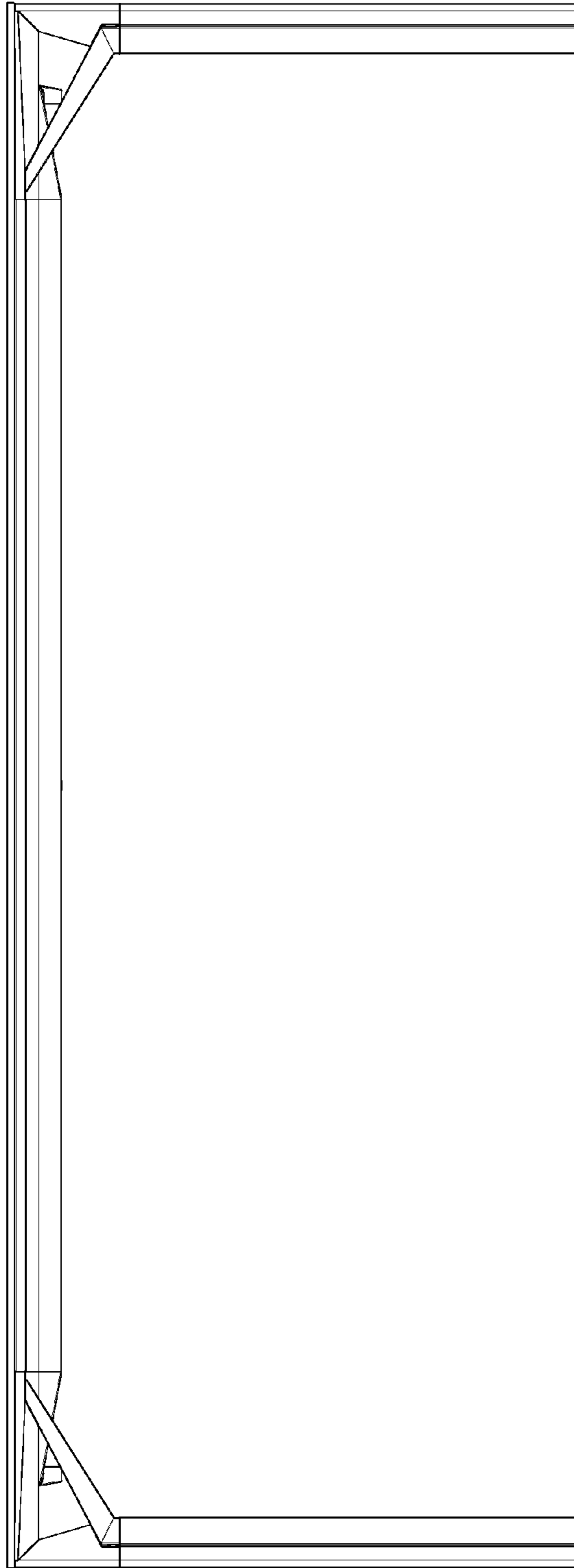

Fig. 8

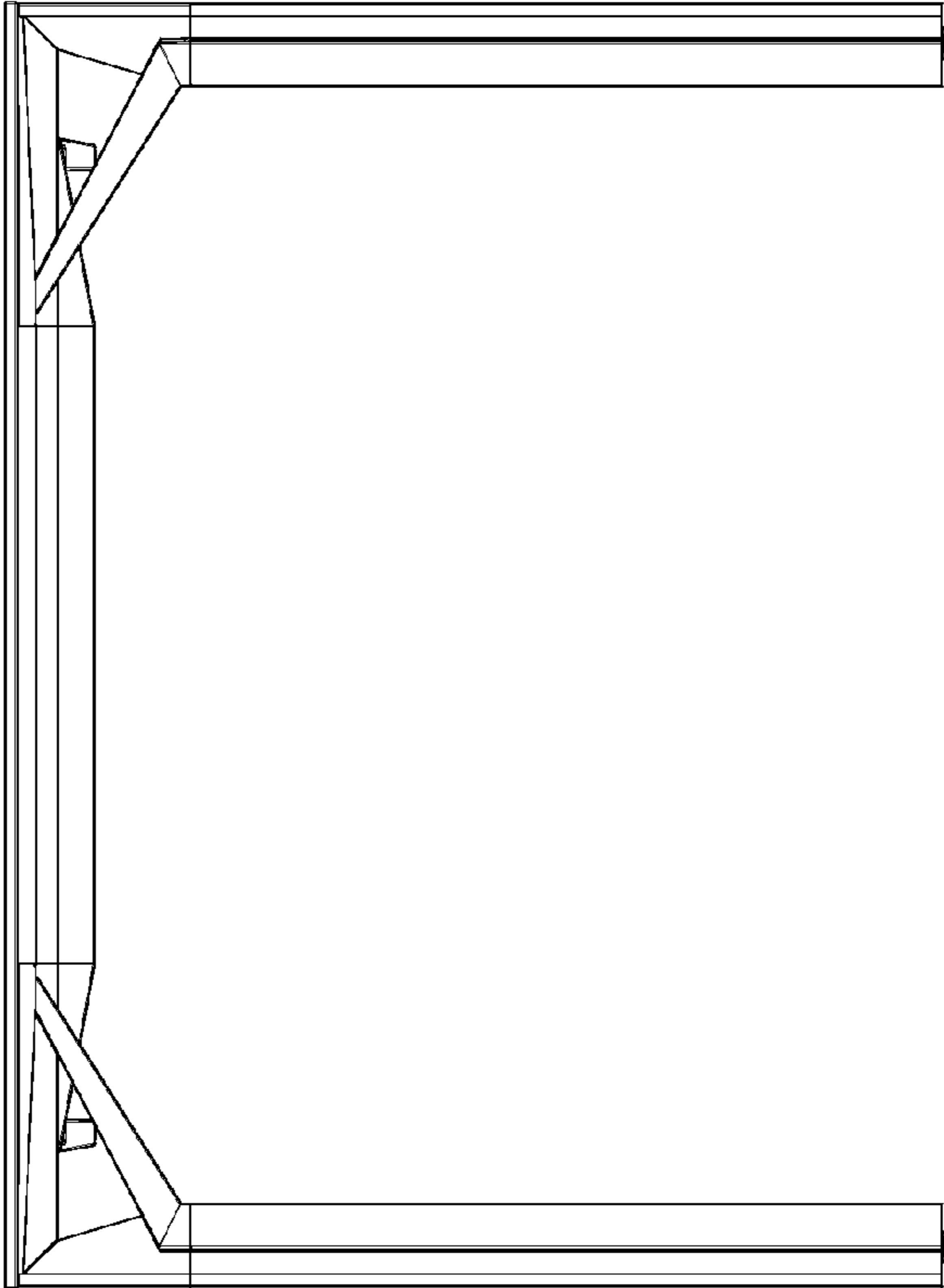

Fig. 9



Fig. 10

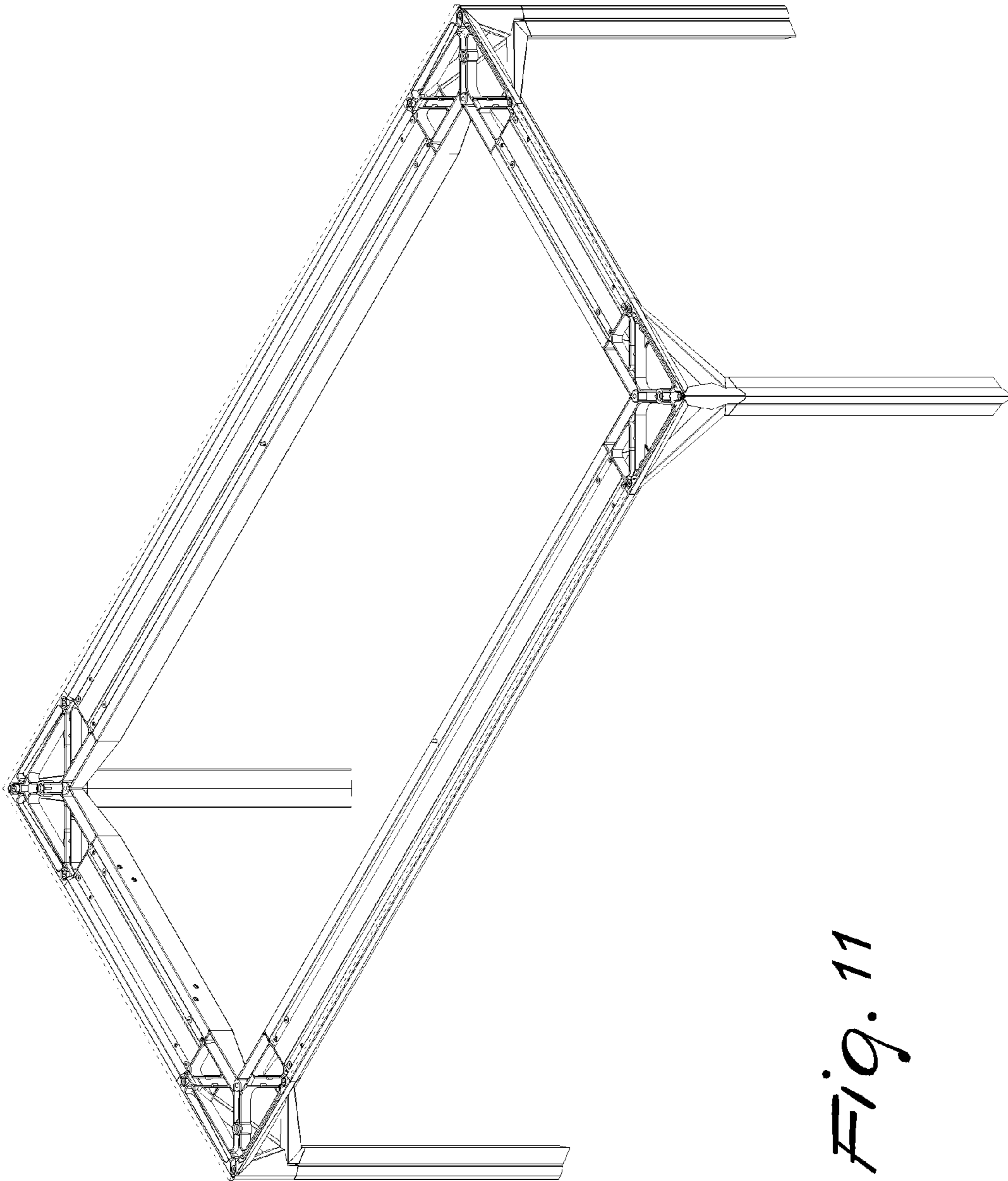

Fig. 11

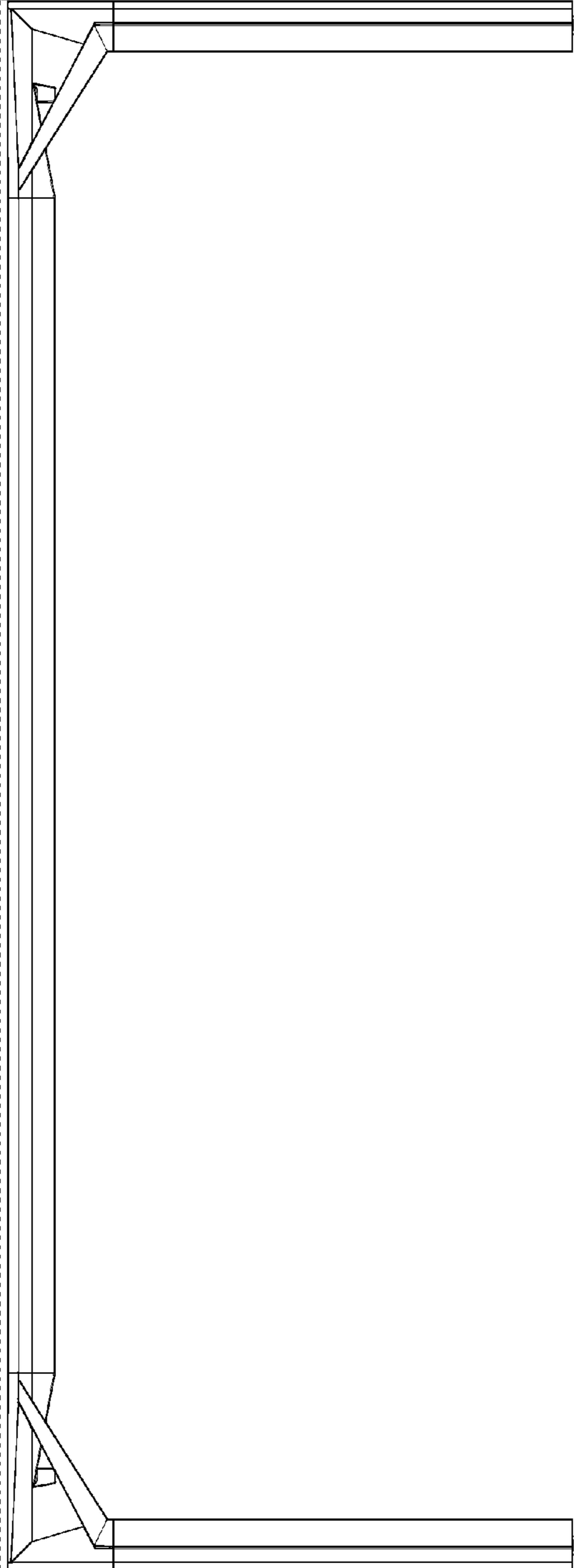

Fig. 12

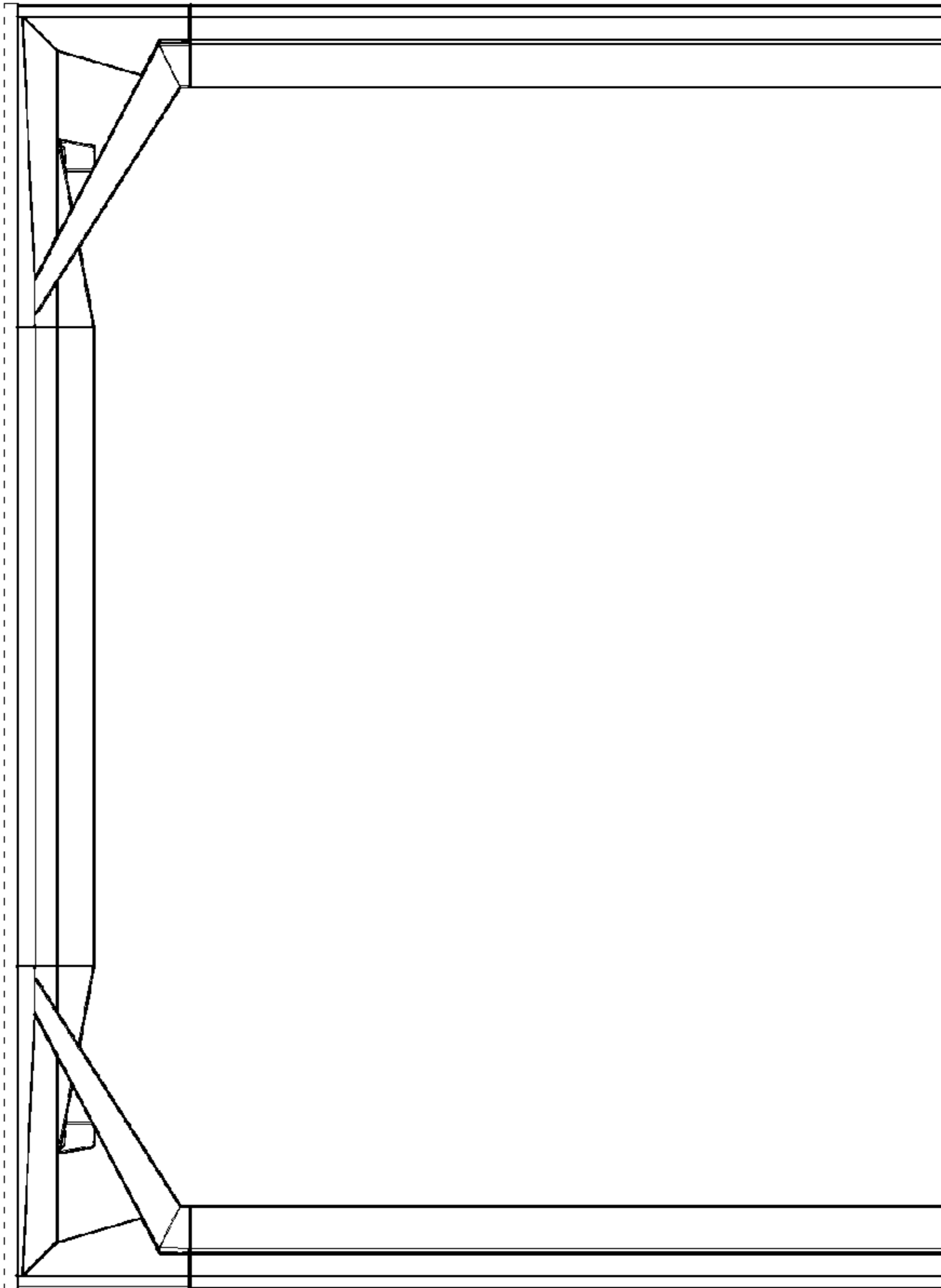

Fig. 13

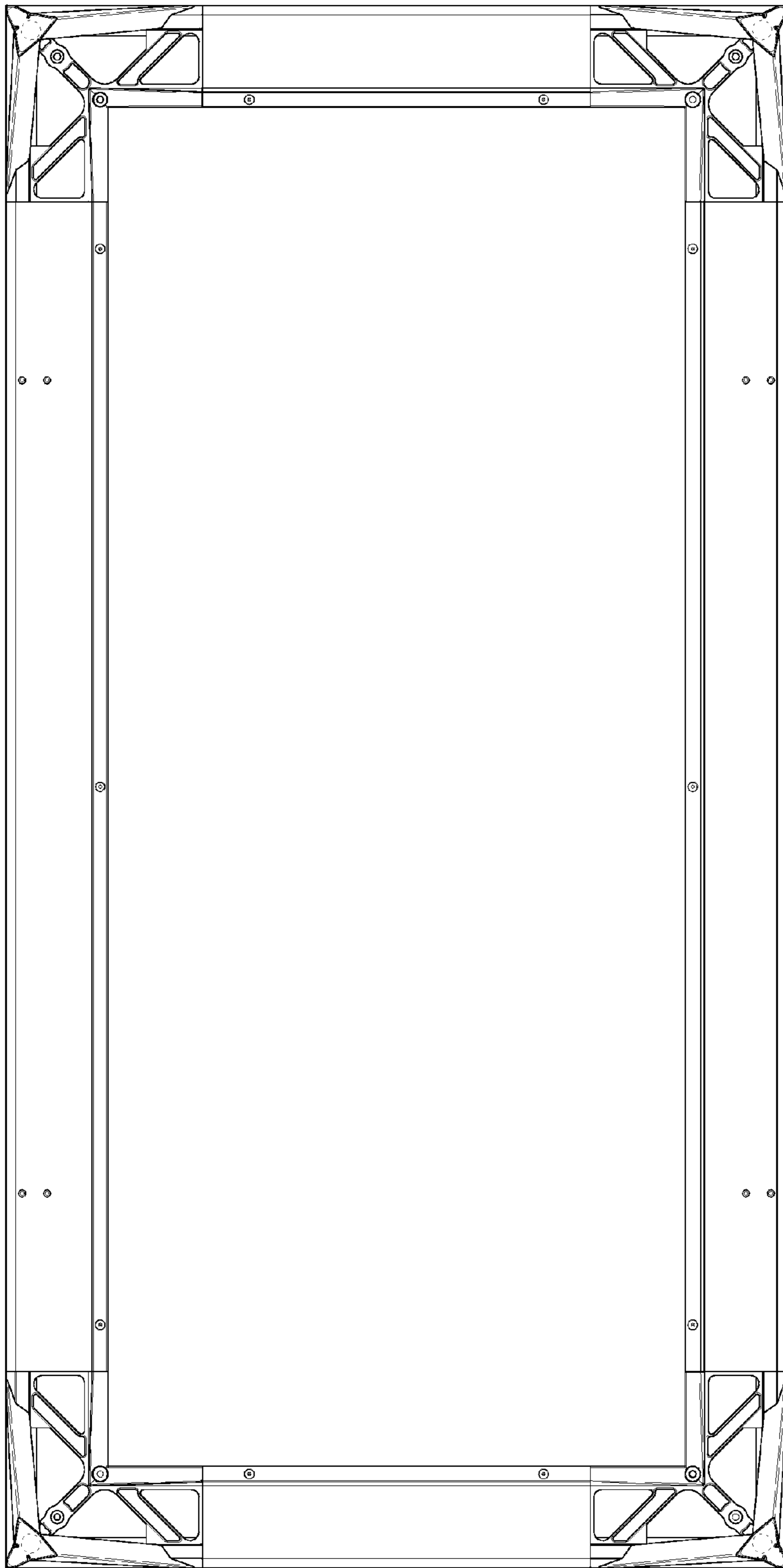

Fig. 14

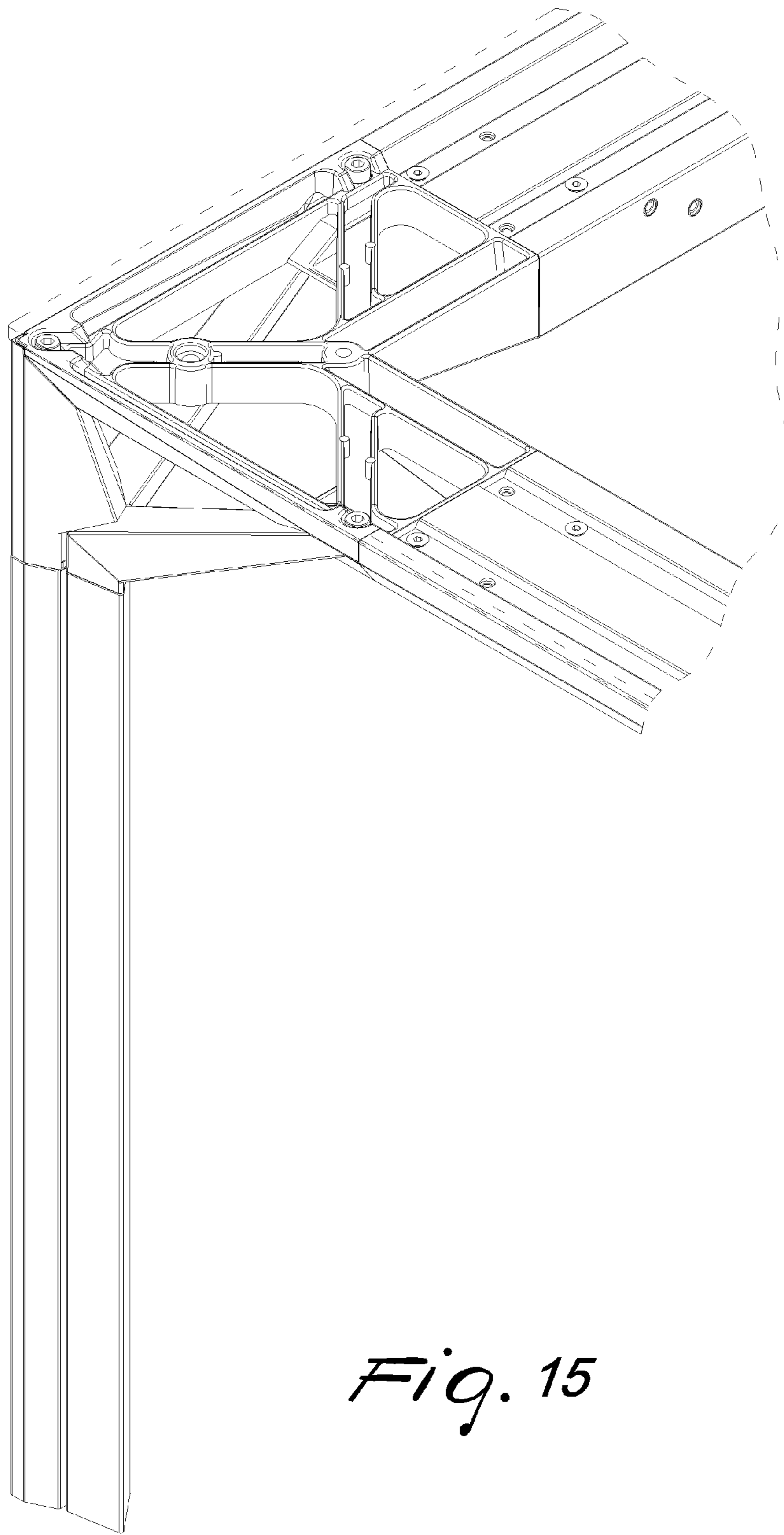

Fig. 15

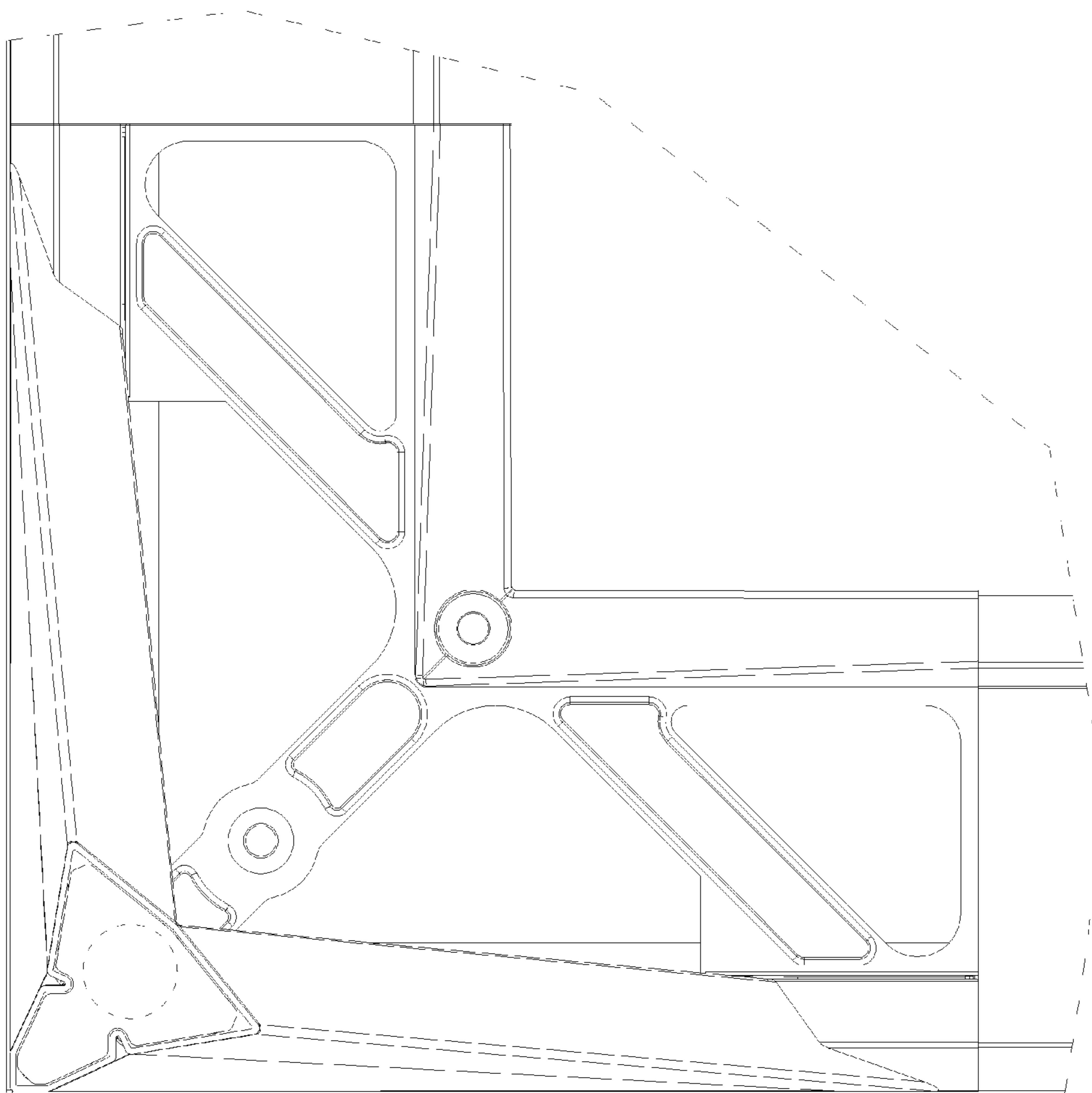

Fig. 16

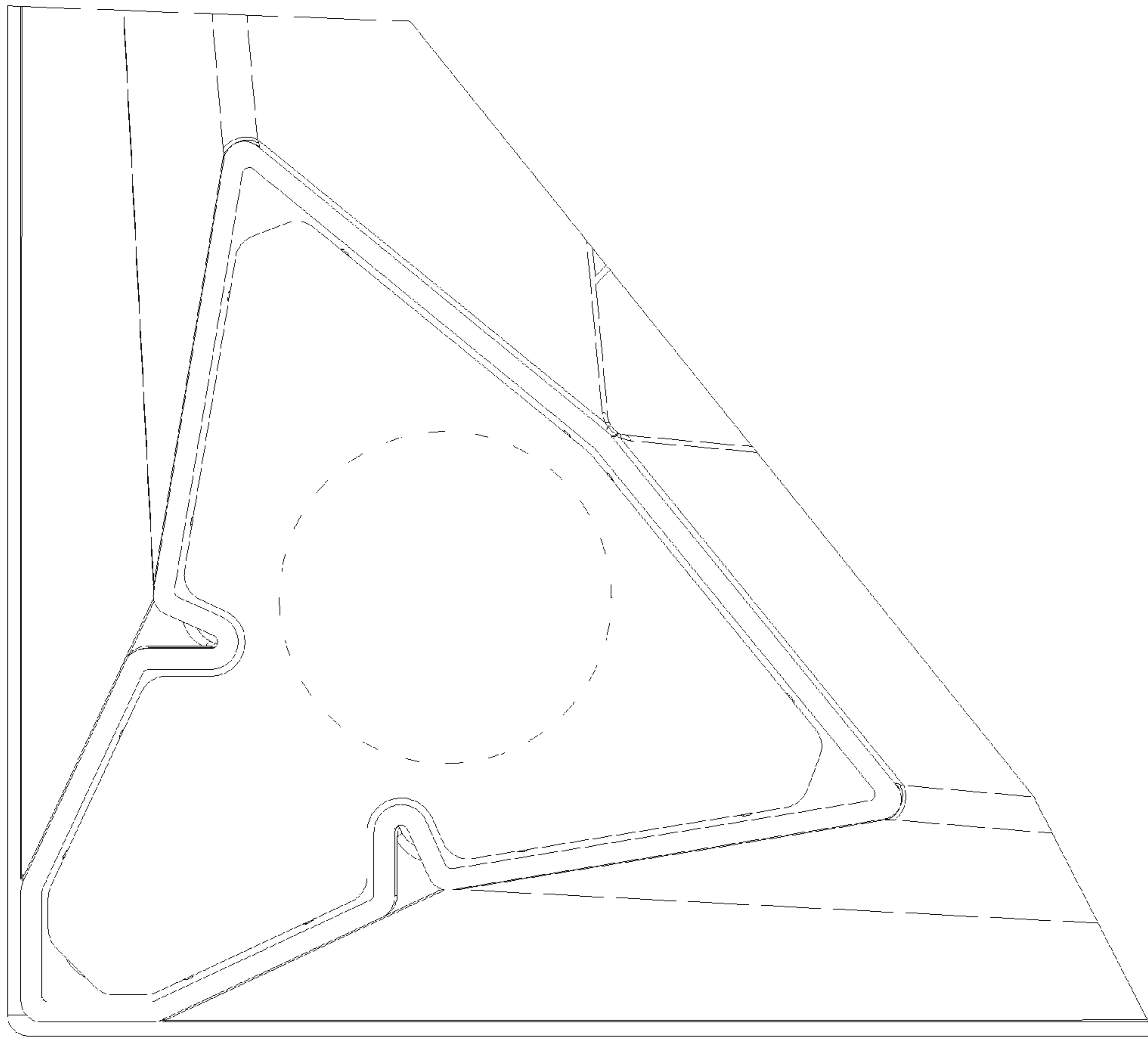

Fig. 17



Fig. 18

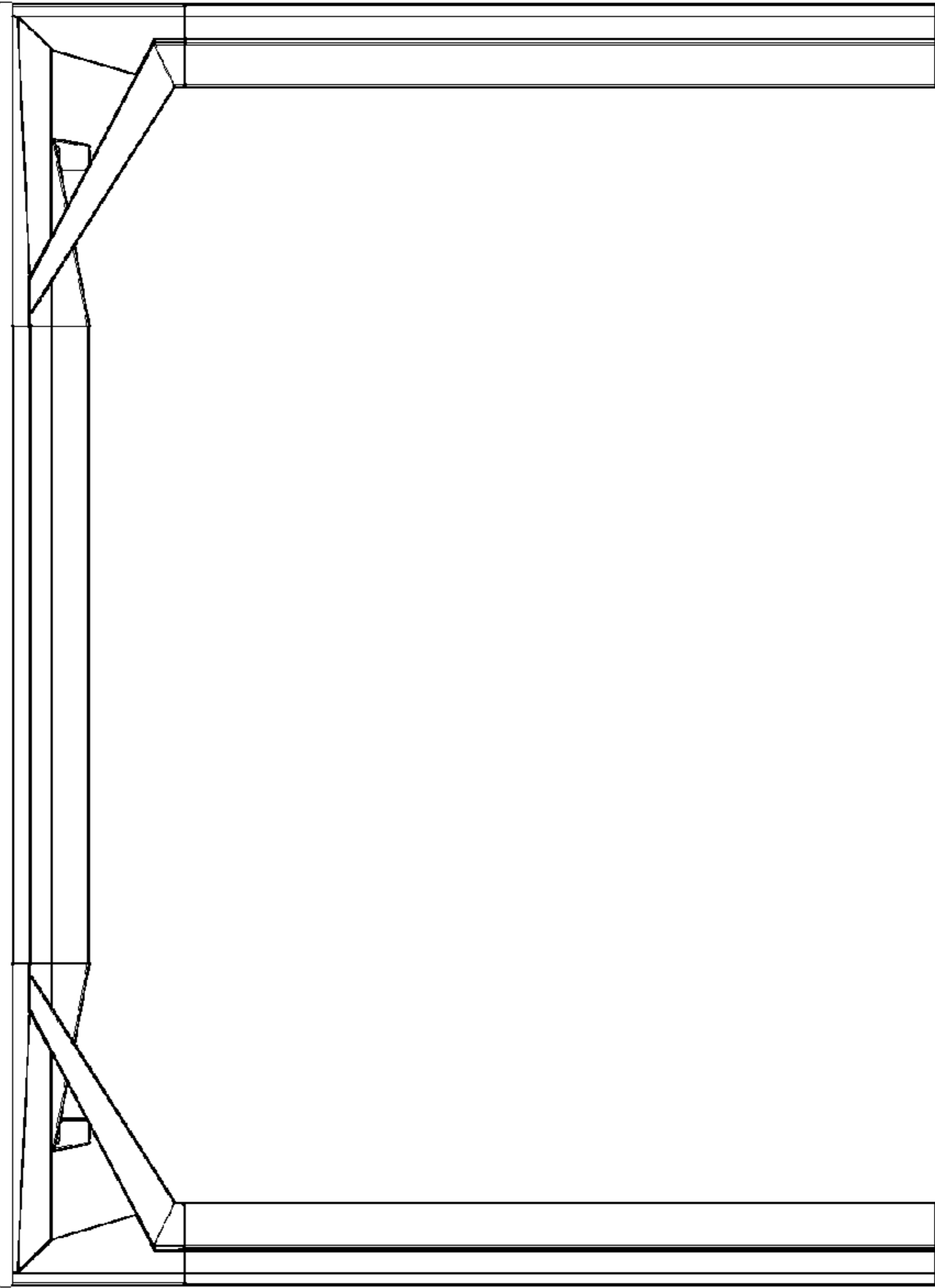

Fig. 19