



US00D683091S

(12) **United States Design Patent**  
**Griffin et al.**

(10) **Patent No.:** **US D683,091 S**

(45) **Date of Patent:** **\*\* May 21, 2013**

(54) **VACUUM CLEANER**

(75) Inventors: **John Griffin**, Phoenix, AZ (US); **Robert L. Crevling, Jr.**, Williamsport, PA (US); **Craig A. Seasholtz**, Avis, PA (US)

(73) Assignee: **Shop Vac Corporation**, Williamsport, PA (US)

(\*\*) Term: **14 Years**

(21) Appl. No.: **29/422,187**

(22) Filed: **May 17, 2012**

(51) **LOC (9) Cl.** ..... **15-05**

(52) **U.S. Cl.**  
USPC ..... **D32/23**

(58) **Field of Classification Search** ..... D32/18,  
D32/21, 23-24, 31; 15/319-321, 353, 347,  
15/327.1-327.2, 327.4, 327.6-327.7, 329,  
15/340.2; 55/DIG. 3, 375  
See application file for complete search history.

(56) **References Cited**

**U.S. PATENT DOCUMENTS**

D507,386	S	*	7/2005	Griffin et al.	.....	D32/21
D527,503	S		8/2006	Griffin et al.		
D527,504	S	*	8/2006	Griffin et al.	.....	D32/21
D528,255	S	*	9/2006	Griffin et al.	.....	D32/21
D587,414	S	*	2/2009	Griffin et al.	.....	D32/31
D588,761	S	*	3/2009	Griffin	.....	D32/31
D591,467	S	*	4/2009	Griffin et al.	.....	D32/23
D599,968	S	*	9/2009	Crevling et al.	.....	D32/23
D631,216	S		1/2011	Crevling et al.		
D633,668	S	*	3/2011	Griffin et al.	.....	D32/23
D634,084	S	*	3/2011	Griffin et al.	.....	D32/31

D638,180	S	*	5/2011	Griffin et al.	.....	D32/31
D640,024	S	*	6/2011	Crevling et al.	.....	D32/31
D644,801	S	*	9/2011	Crevling et al.	.....	D32/31

**OTHER PUBLICATIONS**

Griffin et al., U.S. Appl. No. 29/420,974, filed May 15, 2012.

\* cited by examiner

*Primary Examiner* — Ruth McInroy

(74) *Attorney, Agent, or Firm* — Marshall, Gerstein & Borun LLP

(57) **CLAIM**

The ornamental design for a vacuum cleaner, as shown and described.

**DESCRIPTION**

FIG. 1 is a top, front and right side perspective view of a vacuum cleaner showing our new design; FIG. 2 is a front elevation view thereof; FIG. 3 is a right side elevation view thereof; FIG. 4 is a rear elevation view thereof; FIG. 5 is a left side elevation view thereof; FIG. 6 is a top plan view thereof; FIG. 7 is a top, front and right side perspective view of a second embodiment thereof; FIG. 8 is a front elevation view of FIG. 7; FIG. 9 is a right side elevation view of FIG. 7; FIG. 10 is a rear elevation view of FIG. 7; FIG. 11 is a left side elevation view of FIG. 7; and, FIG. 12 is a top plan view of FIG. 7.

The portion of the vacuum cleaner shown in broken lines is for illustrative purposes only and forms no part of the claimed design.

**1 Claim, 12 Drawing Sheets**

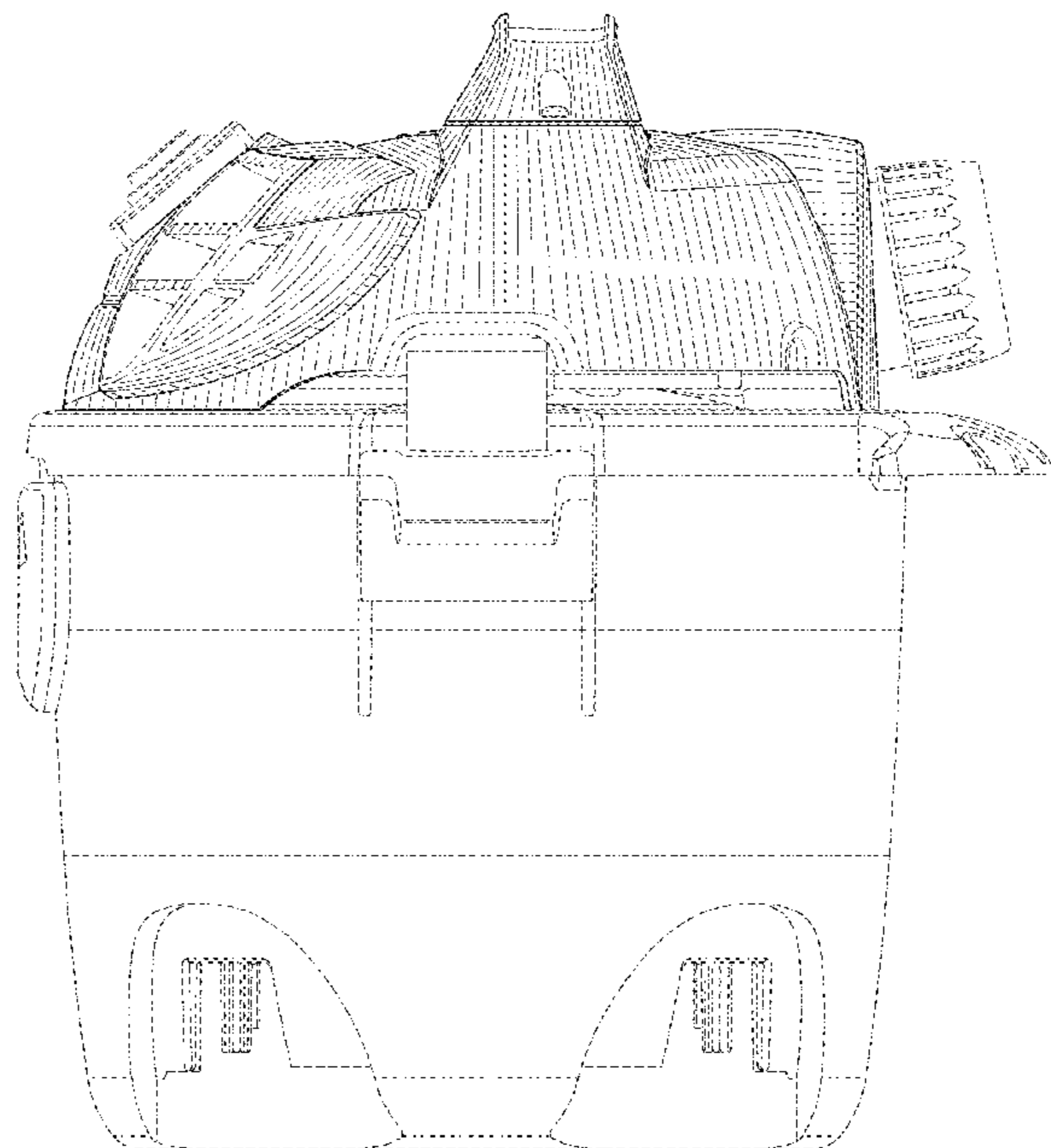
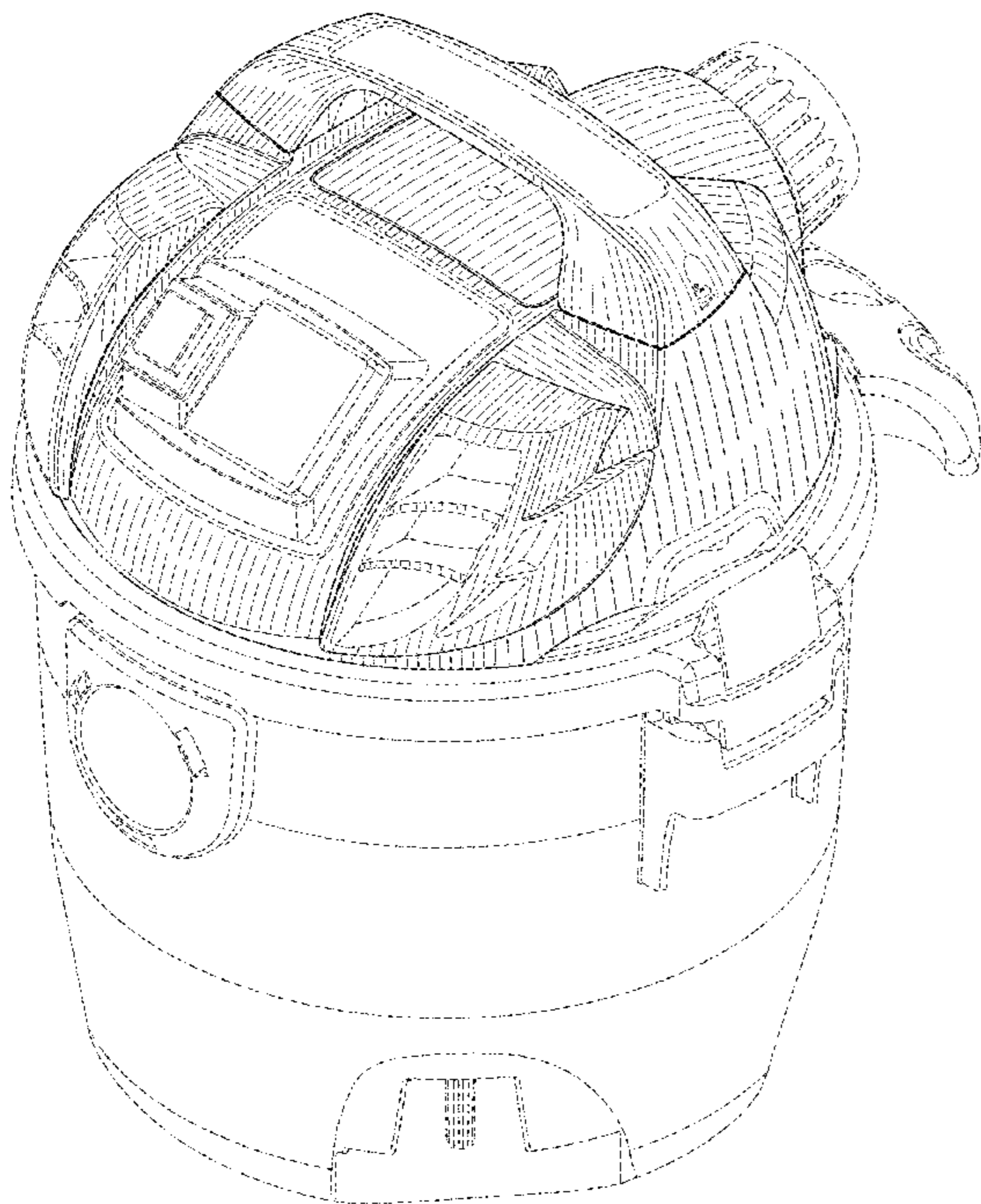

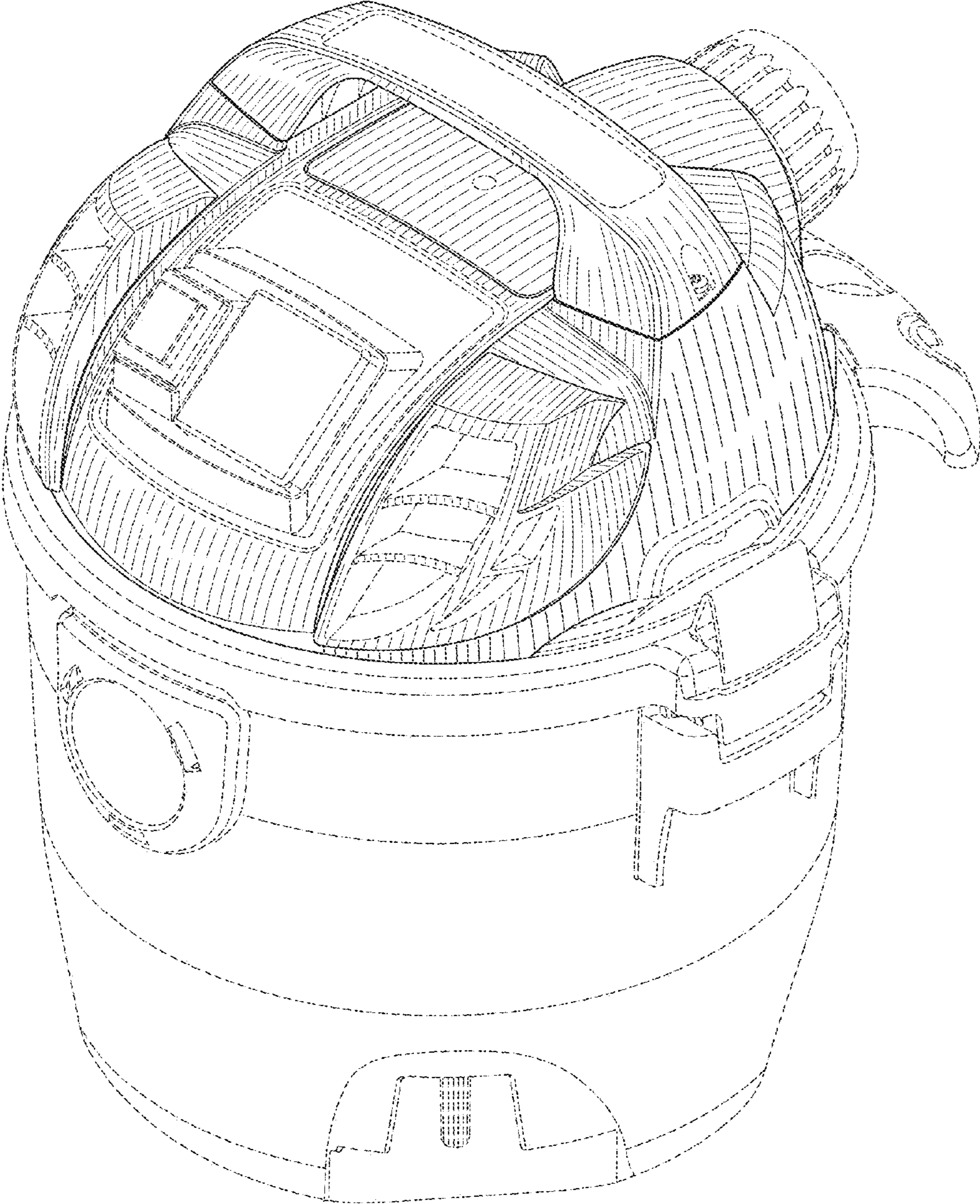

FIG. 1

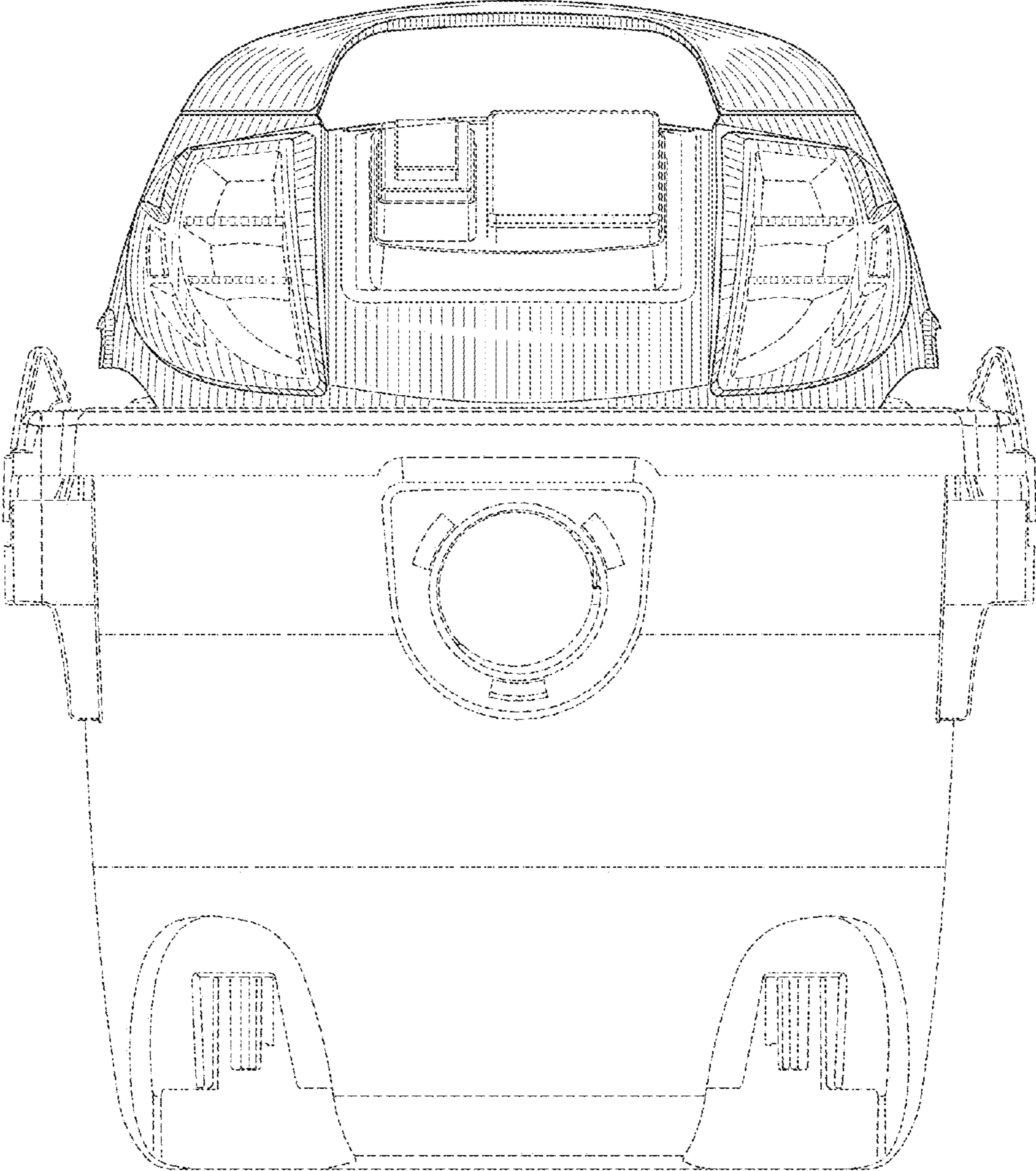

FIG. 2

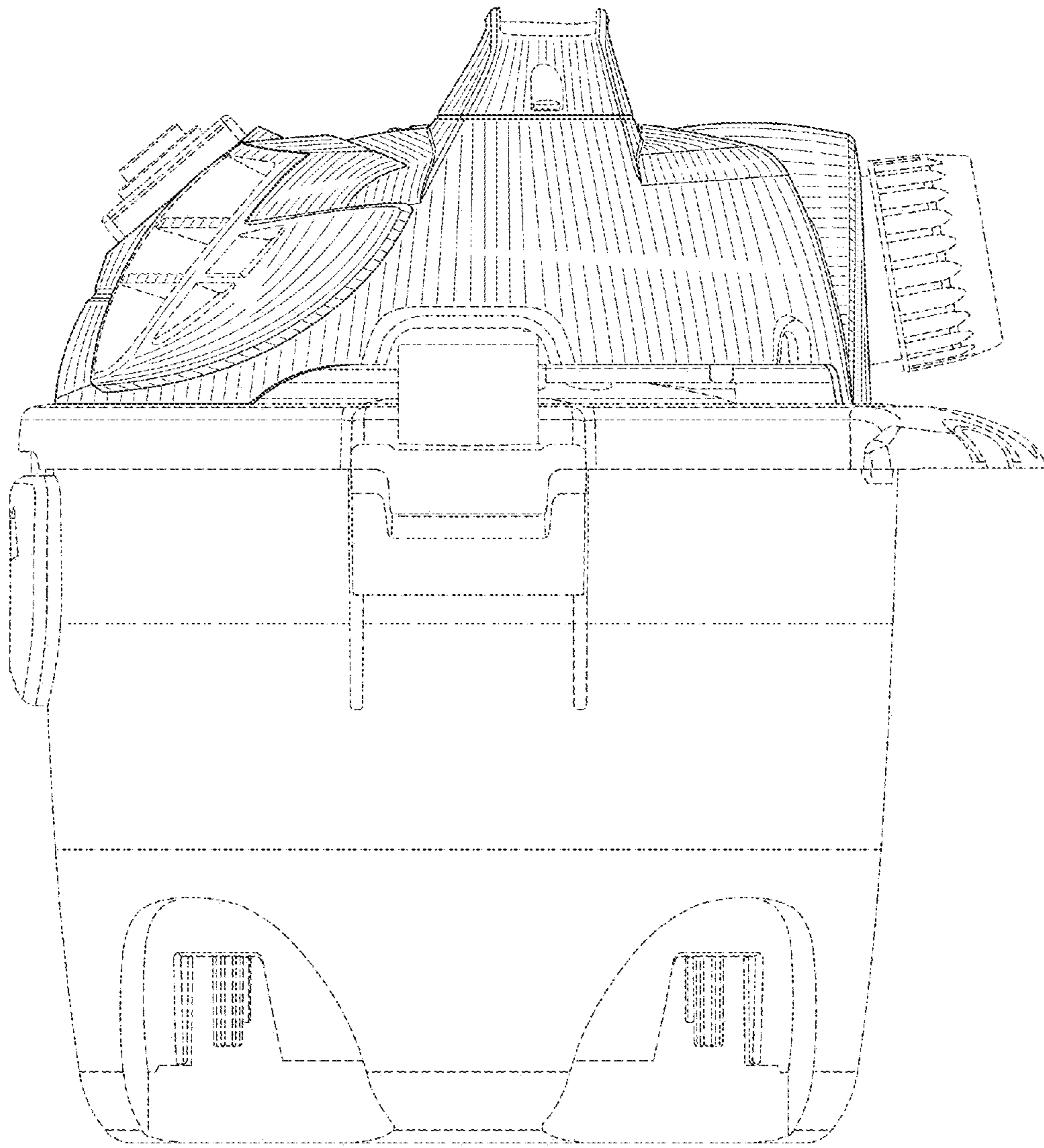

FIG. 3

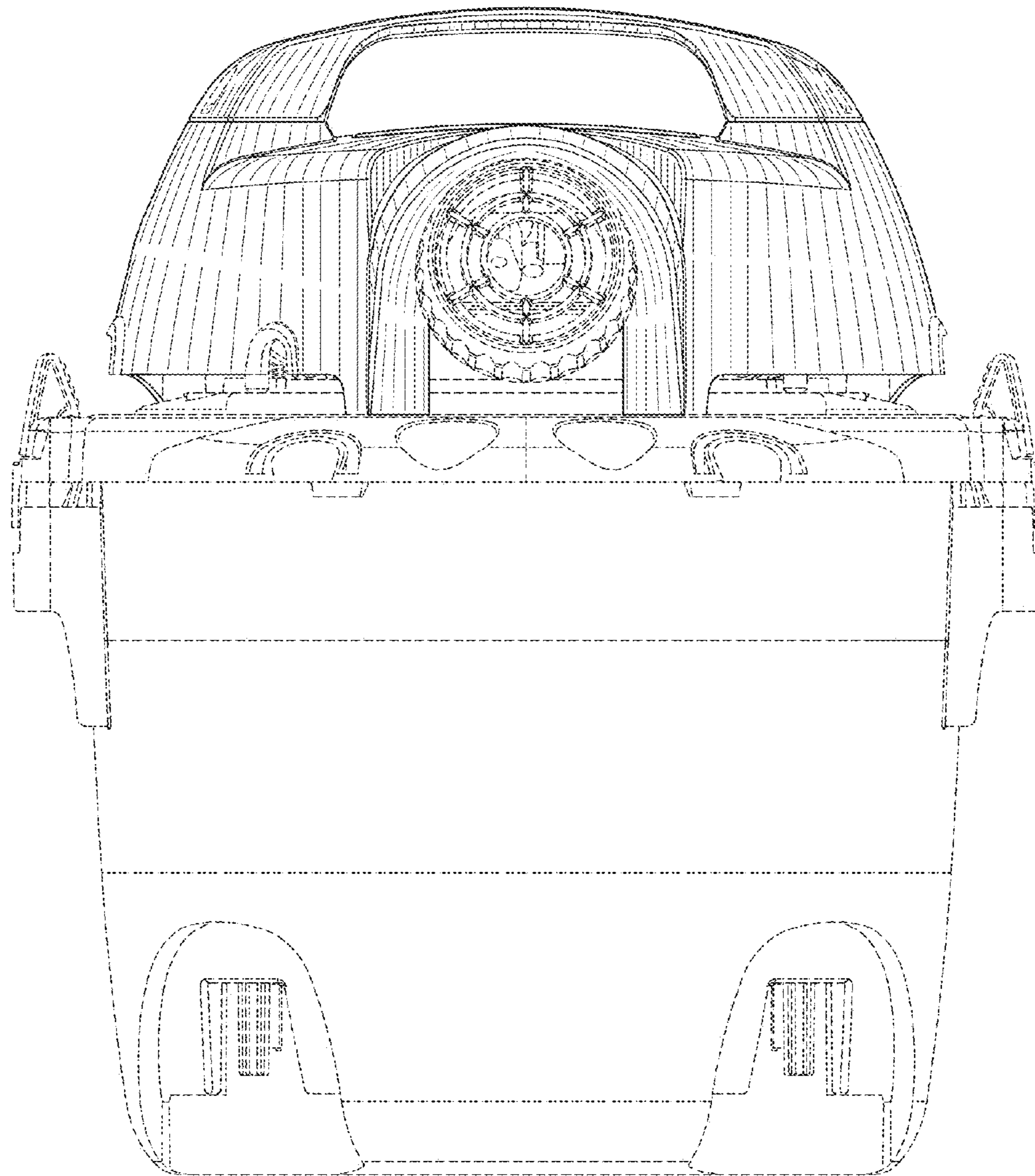

FIG. 4

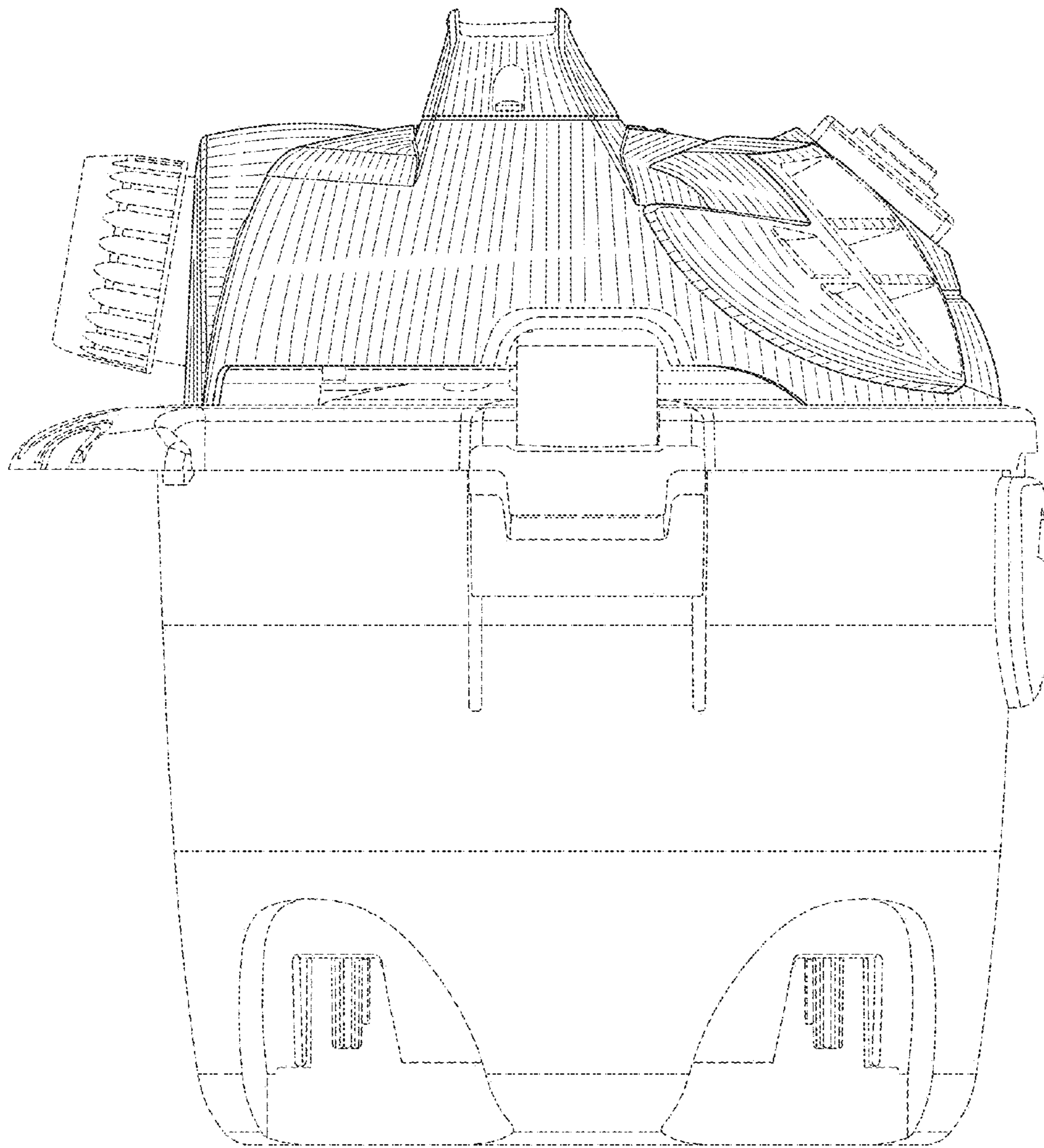

FIG. 5

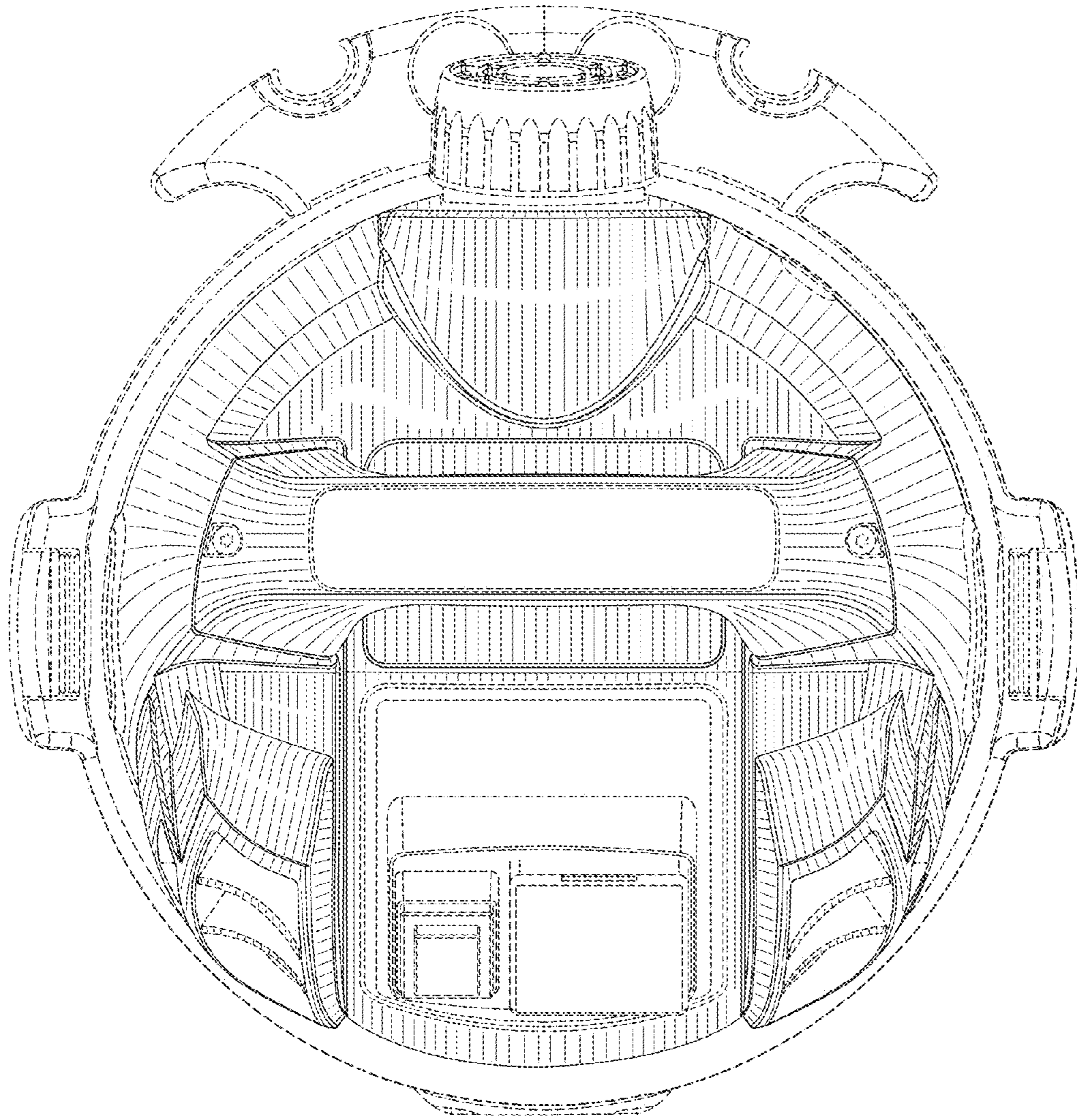

FIG. 6

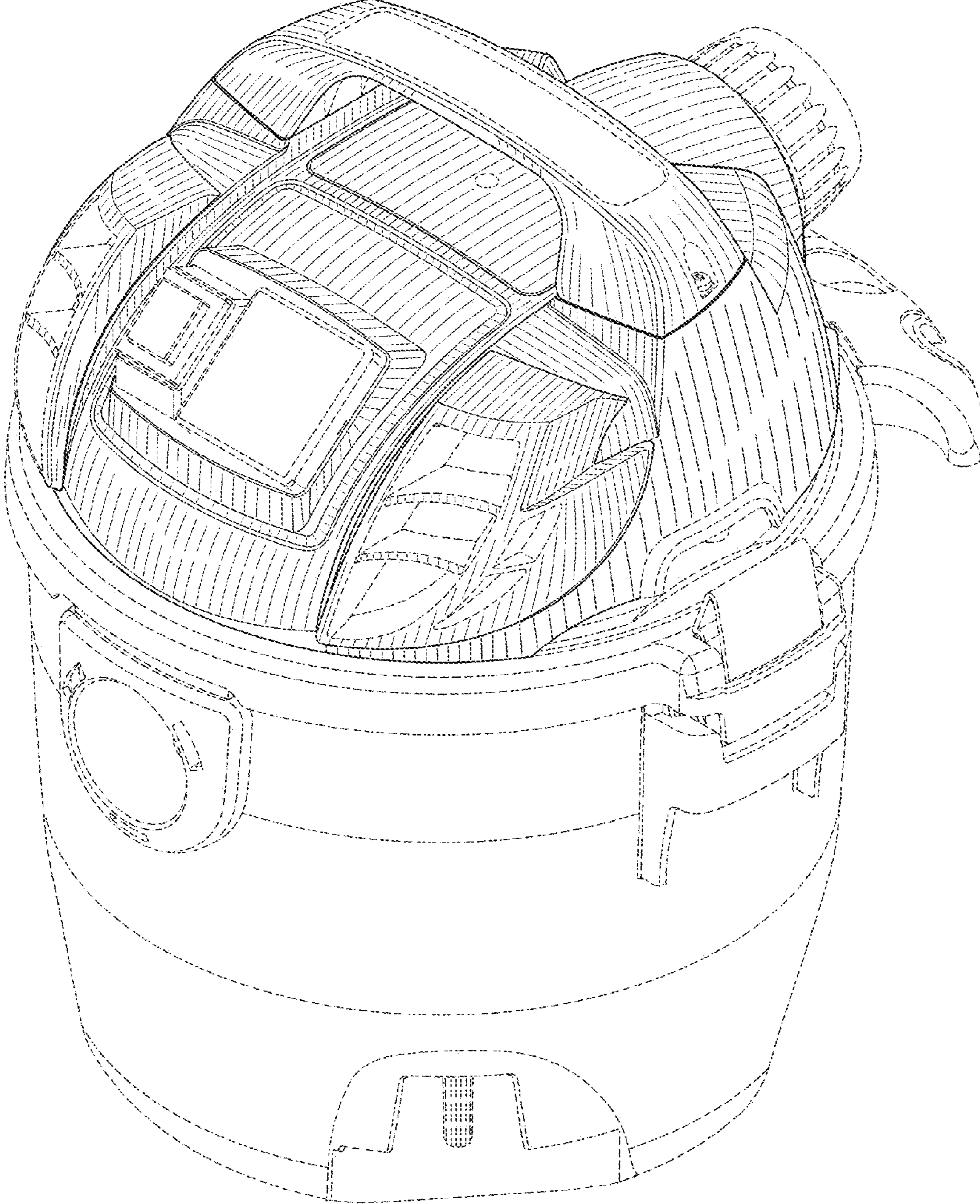

FIG. 7



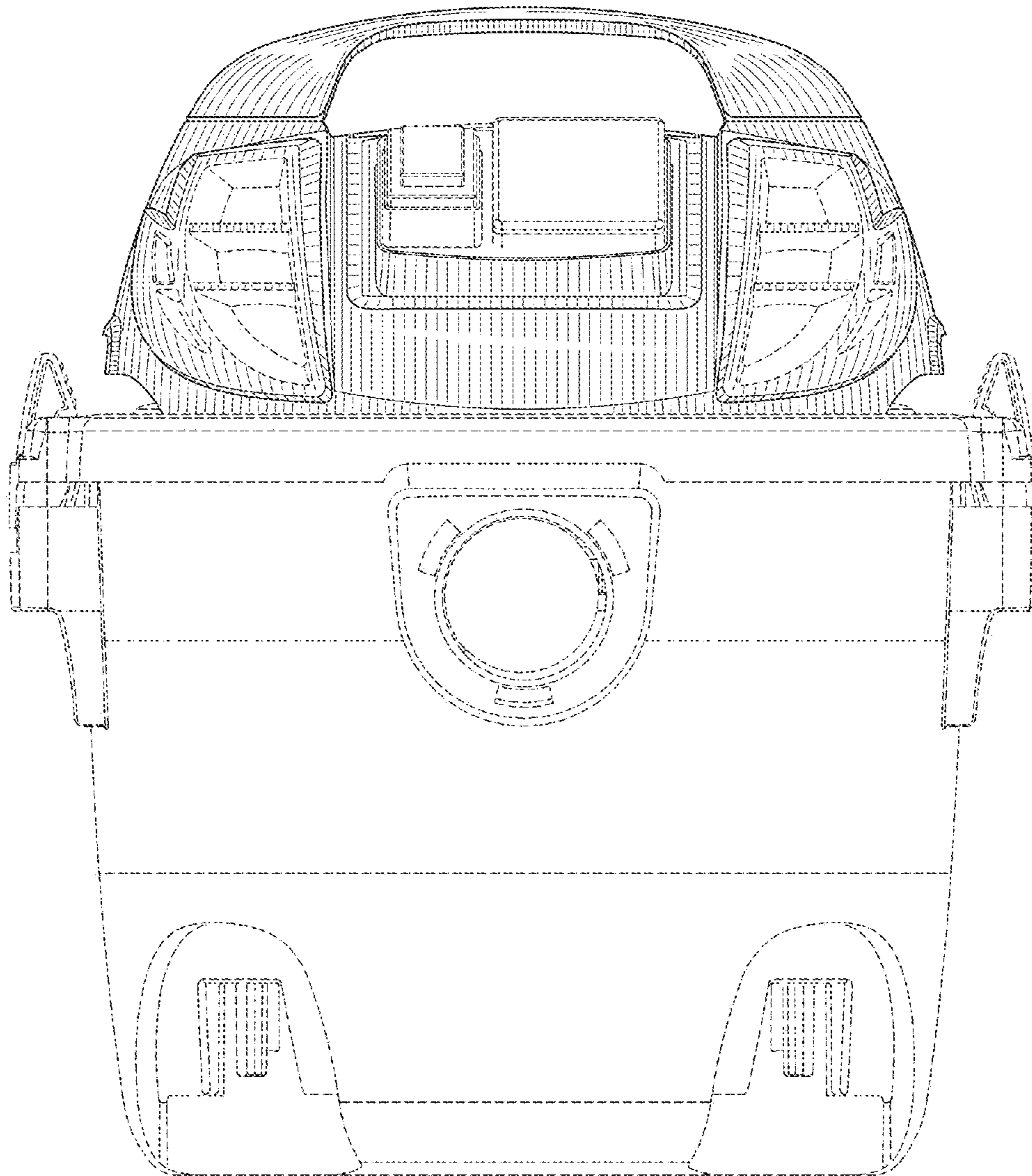

FIG. 8

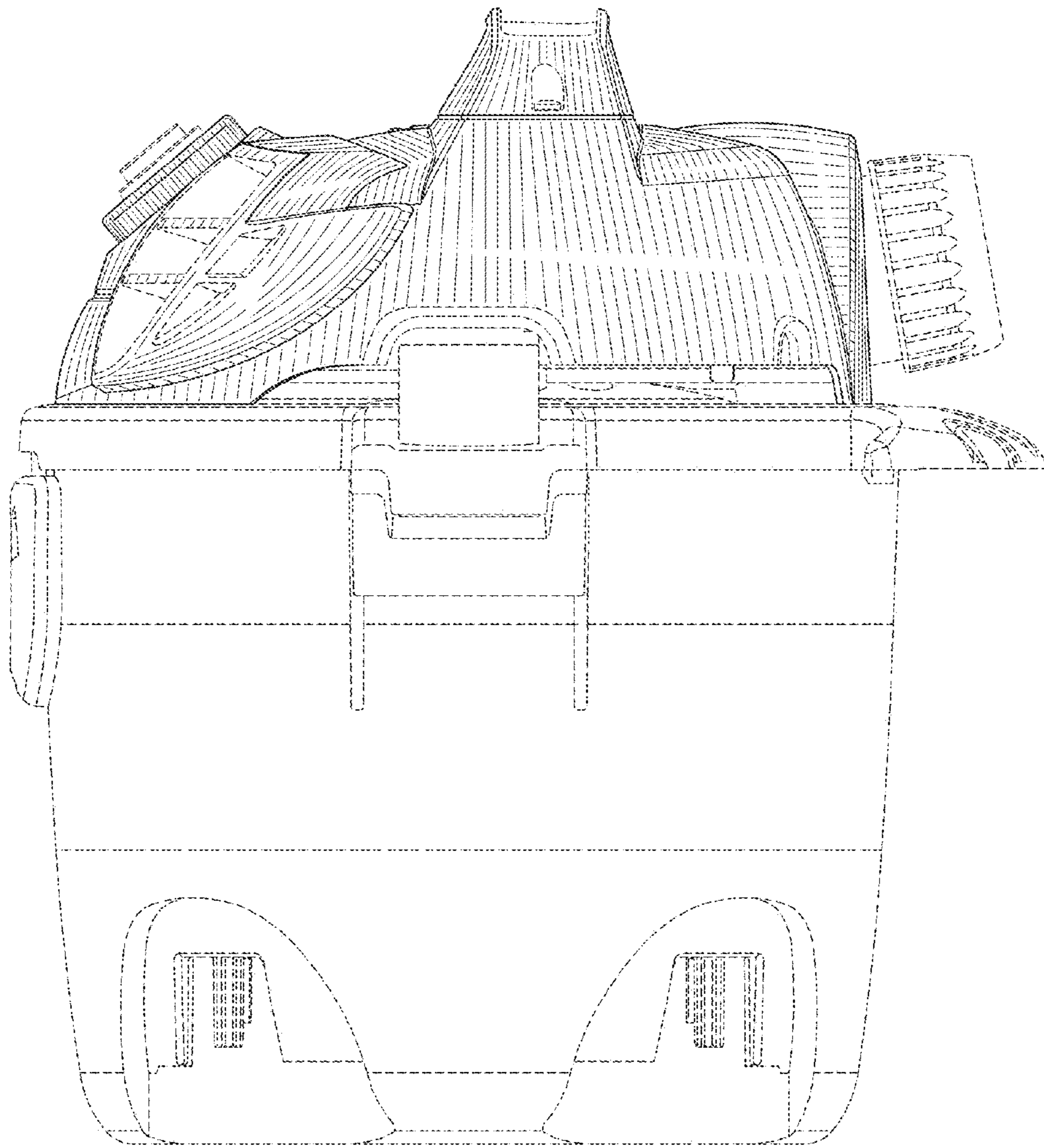

FIG. 9

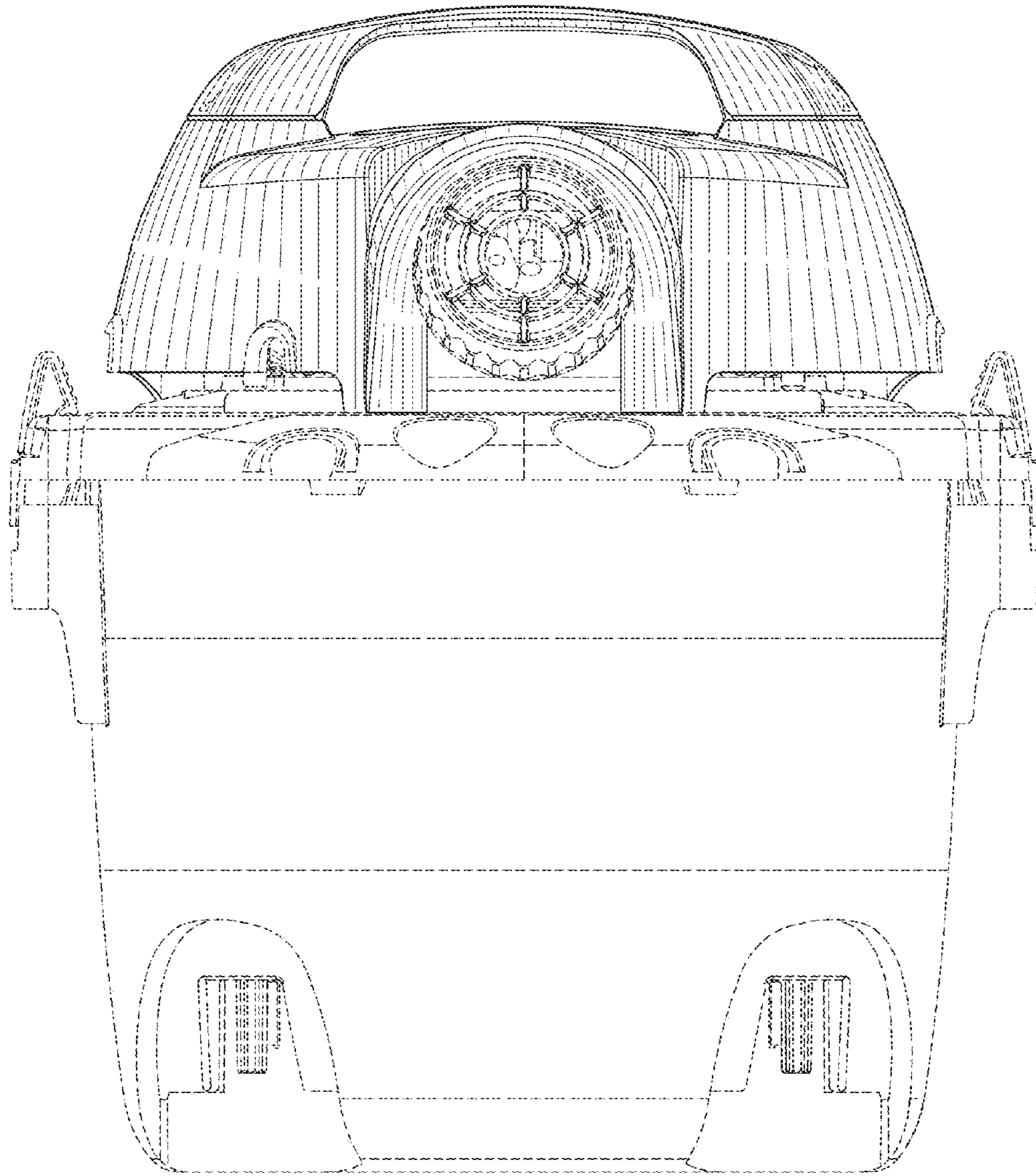

FIG. 10

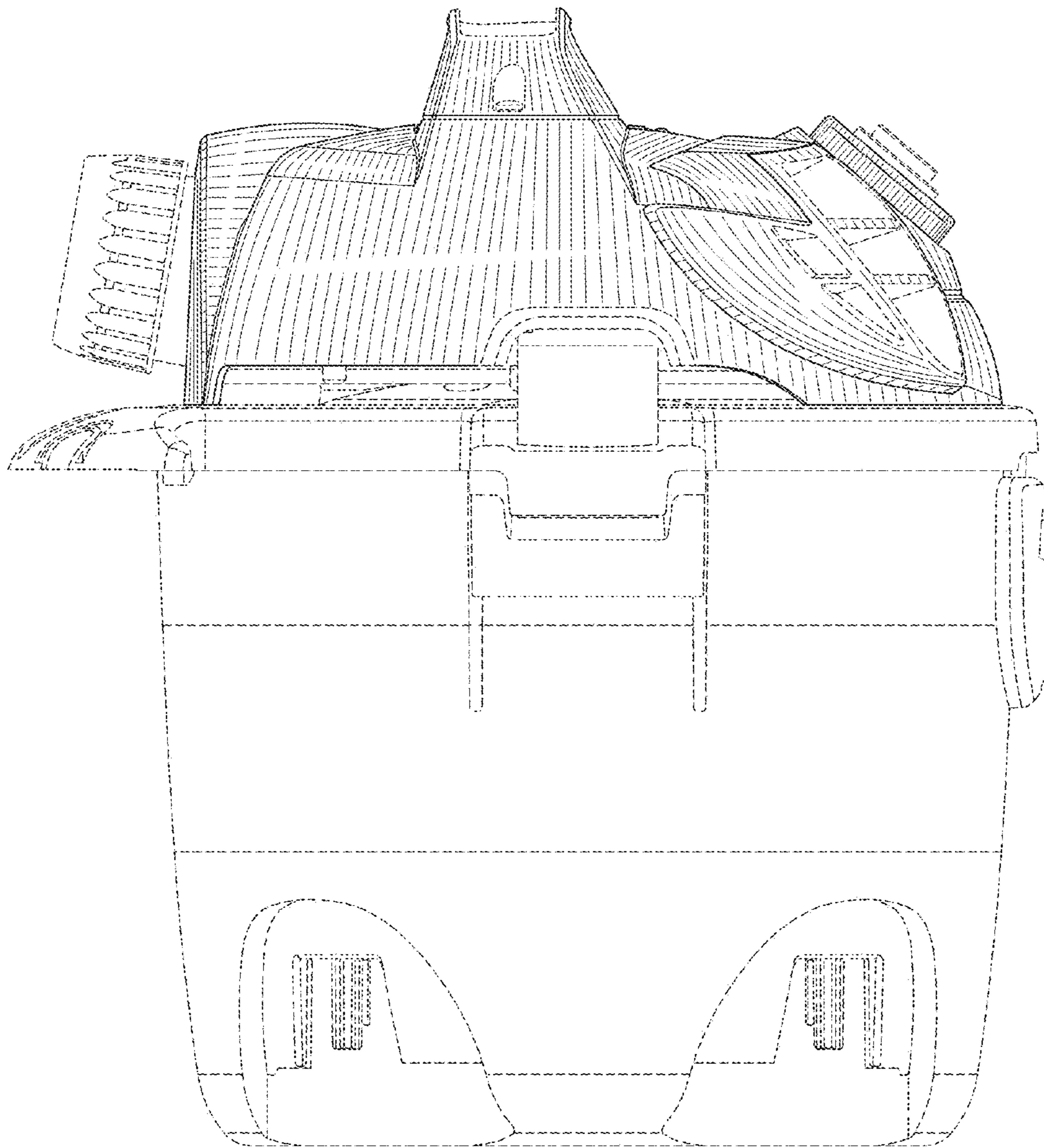

FIG. 11

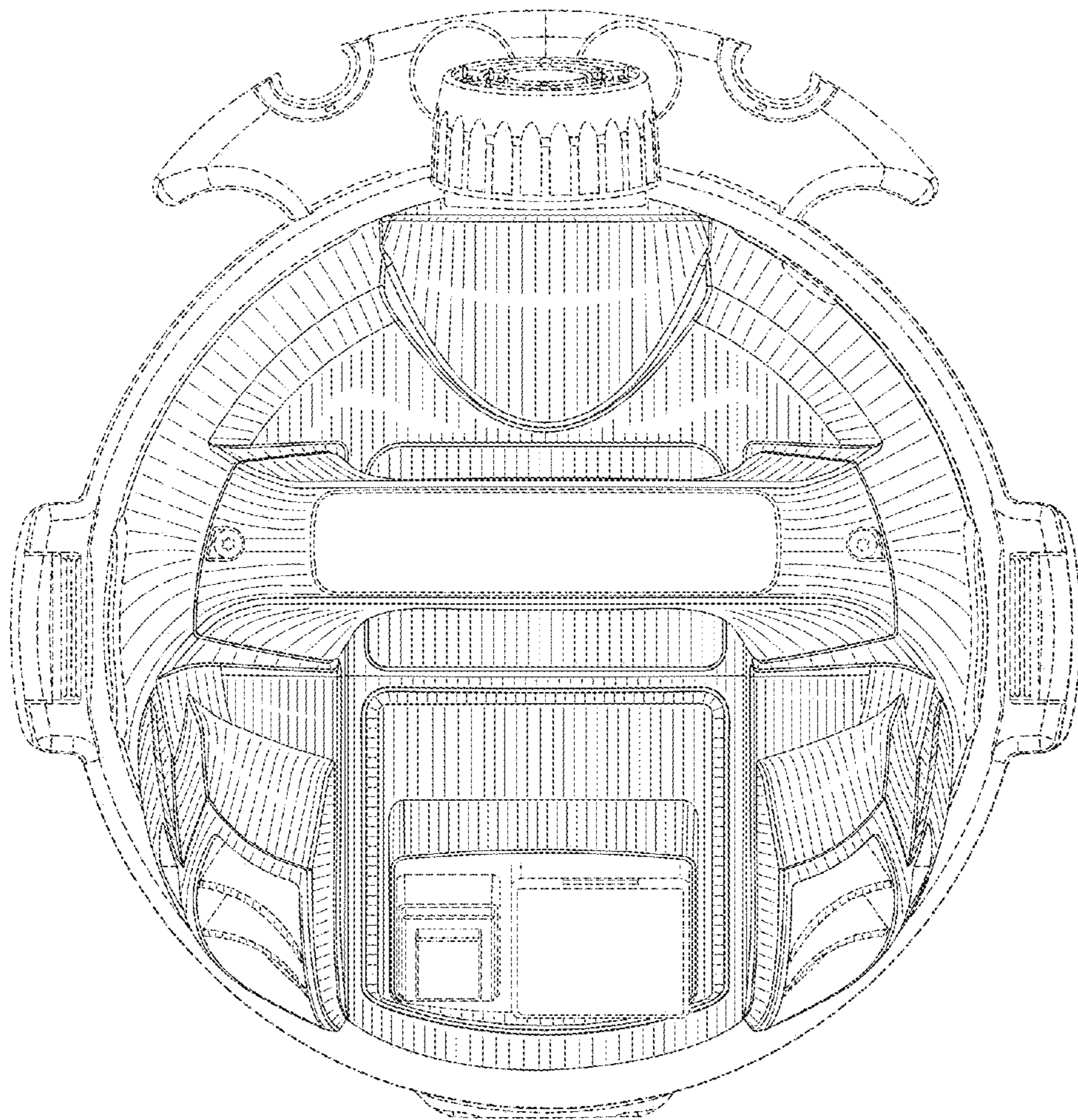

FIG. 12