



US00D683051S

(12) **United States Design Patent**
Scott et al.

(10) **Patent No.:** **US D683,051 S**
(45) **Date of Patent:** **** May 21, 2013**

(54) **CONSTRUCTION ARCH**

DESCRIPTION

(75) Inventors: **Wesley M. Scott**, Fort Worth, TX (US);
Russell P. Scott, Arlington, TX (US);
Matthew J. Scott, Fort Worth, TX (US)

(73) Assignee: **Scottera Corp.**, Grand Prairie, TX (US)

(**) Term: **14 Years**

(21) Appl. No.: **29/413,812**

(22) Filed: **Feb. 21, 2012**

(51) **LOC (9) Cl.** **25-02**

(52) **U.S. Cl.**
USPC **D25/60**

(58) **Field of Classification Search** D25/102;
52/86, 88, 656.1, 766, 631, 656.4, 657
See application file for complete search history.

(56) **References Cited**

U.S. PATENT DOCUMENTS

1,471,159 A * 10/1923 Howie et al. 52/690
6,128,864 A * 10/2000 Barry et al. 52/86

(Continued)

FOREIGN PATENT DOCUMENTS

CA 2241586 6/1998

OTHER PUBLICATIONS

www.instantarch.com; "Instant Arch"; Mar. 9, 2012; 2 pgs.

(Continued)

Primary Examiner — Doris Clark

(74) *Attorney, Agent, or Firm* — Stetina Brunda Garred & Brucker

(57) **CLAIM**

The ornamental design for a construction arch, as shown and described.

FIG. 1 is a lower perspective view of the construction arch of the present invention showing our new design;
FIG. 2 is a top perspective view thereof;
FIG. 3 is a top plan view thereof;
FIG. 4 is front elevational view thereof;
FIG. 5 is side elevational view thereof;
FIG. 6 is a rear elevational view thereof;
FIG. 7 is a bottom plan view thereof;
FIG. 8 is lower perspective view of a second embodiment of the construction arch of the present invention showing our new design;
FIG. 9 is a top perspective view thereof;
FIG. 10 is a top plan view thereof;
FIG. 11 is a front elevational view thereof;
FIG. 12 is a side elevational view thereof;
FIG. 13 is a rear elevational view thereof;
FIG. 14 is a bottom plan view thereof;
FIG. 15 is a lower perspective view of a third embodiment of the construction arch of the present invention showing our new design;
FIG. 16 is a top perspective view thereof;
FIG. 17 is a top plan view thereof;
FIG. 18 is a front elevational view thereof;
FIG. 19 is a side elevational view thereof;
FIG. 20 is a rear elevational view thereof;
FIG. 21 is a bottom plan view thereof;
FIG. 22 is a lower perspective view of a fourth embodiment of the construction arch of the present invention showing our new design;
FIG. 23 is a top perspective view thereof;
FIG. 24 is a top plan view thereof;
FIG. 25 is a front elevational view thereof;
FIG. 26 is a side elevational view thereof;
FIG. 27 is a rear elevational view thereof;
FIG. 28 is a bottom plan view thereof; and,
FIG. 29 is an elevational view of the construction arch of the present invention illustrating a use for the construction arch with the dotted lines forming environmental structure and forming no part of the claimed design.

1 Claim, 5 Drawing Sheets

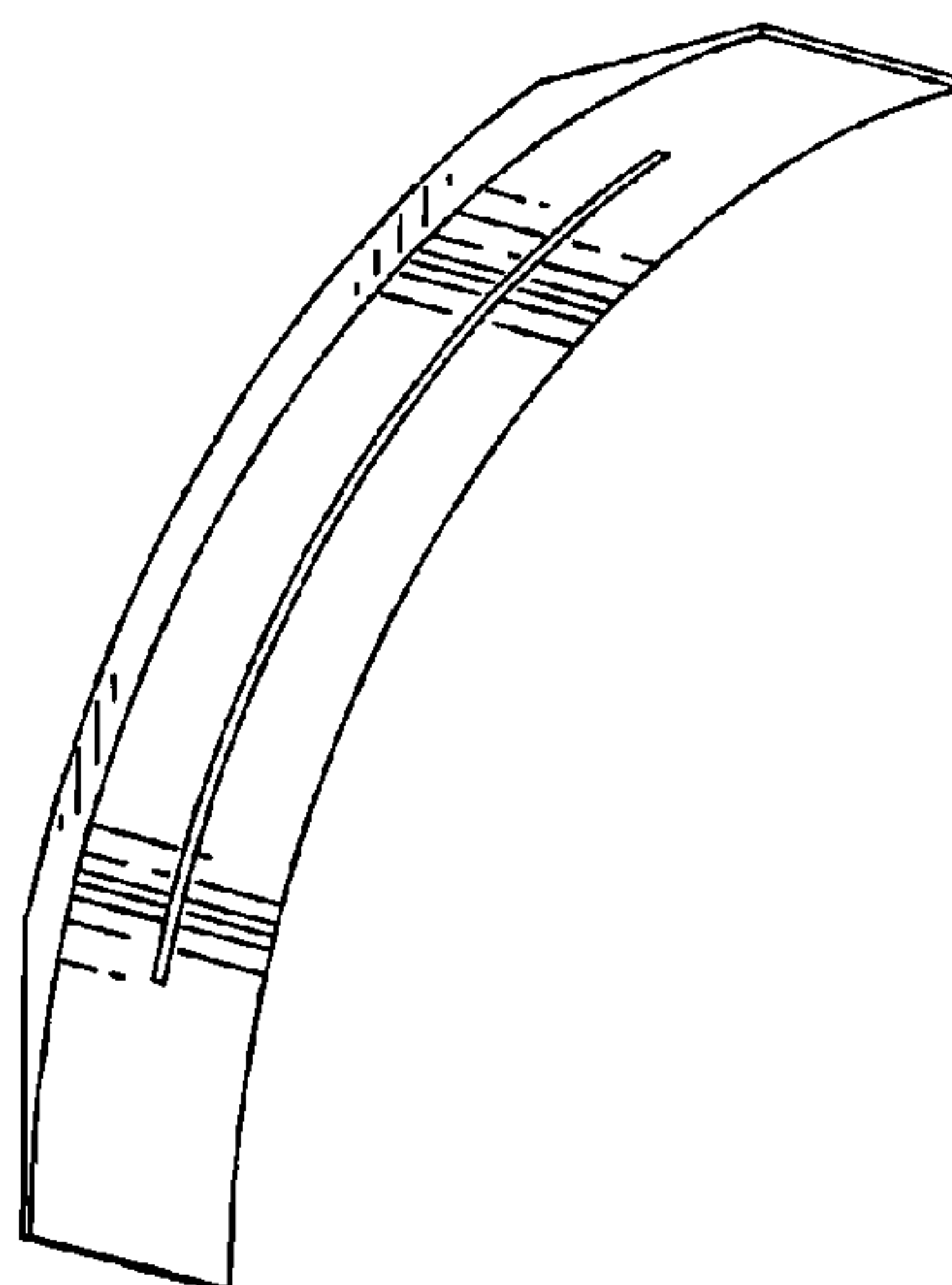

US D683,051 S

Page 2

U.S. PATENT DOCUMENTS

D621,958 S * 8/2010 Summerville, Jr. D25/60
2005/0183347 A1 * 8/2005 Barry et al. 52/86
2006/0174548 A1 * 8/2006 Bass 52/86

OTHER PUBLICATIONS

www.arch-it-co.com; "Your Perfect Arch Is Ready and Waiting";
Mar. 9, 2012; 1 pg.

www.creativecorners.net; "Pre-Fabricated Arched Doorway Kit";
Mar. 9, 2012; 2 pgs.

www.easy-arch.com; "Quarter Circle Arches"; Mar. 9, 2012; 2 pgs.

www.archwaypro.com; "Specification Sheet"; Nov. 16, 2006; 2 pgs.

www.fastarchofamerica.com; "Half Round Arch"; Mar. 9, 2012; 2
pgs.

* cited by examiner

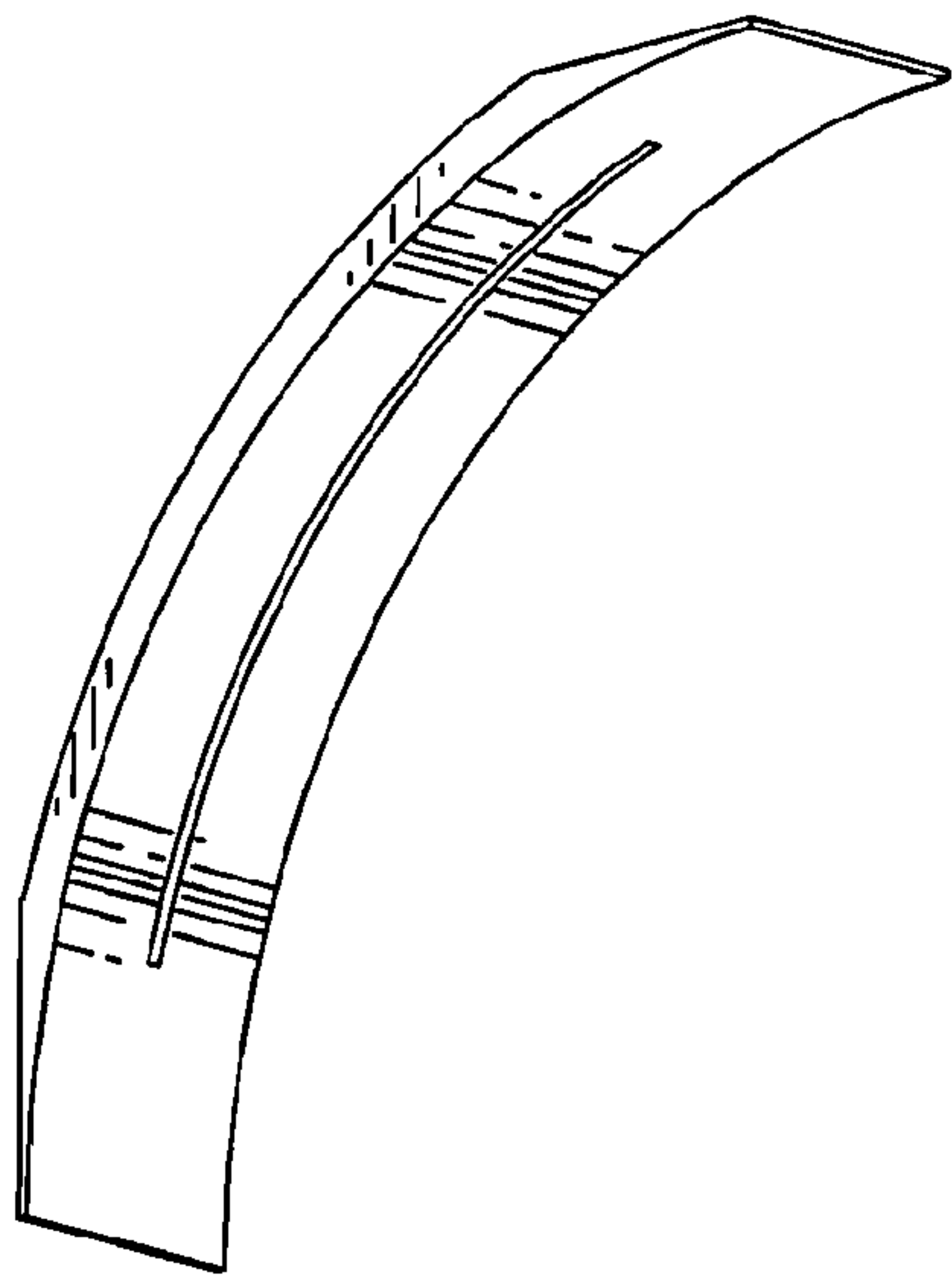

FIG. 1

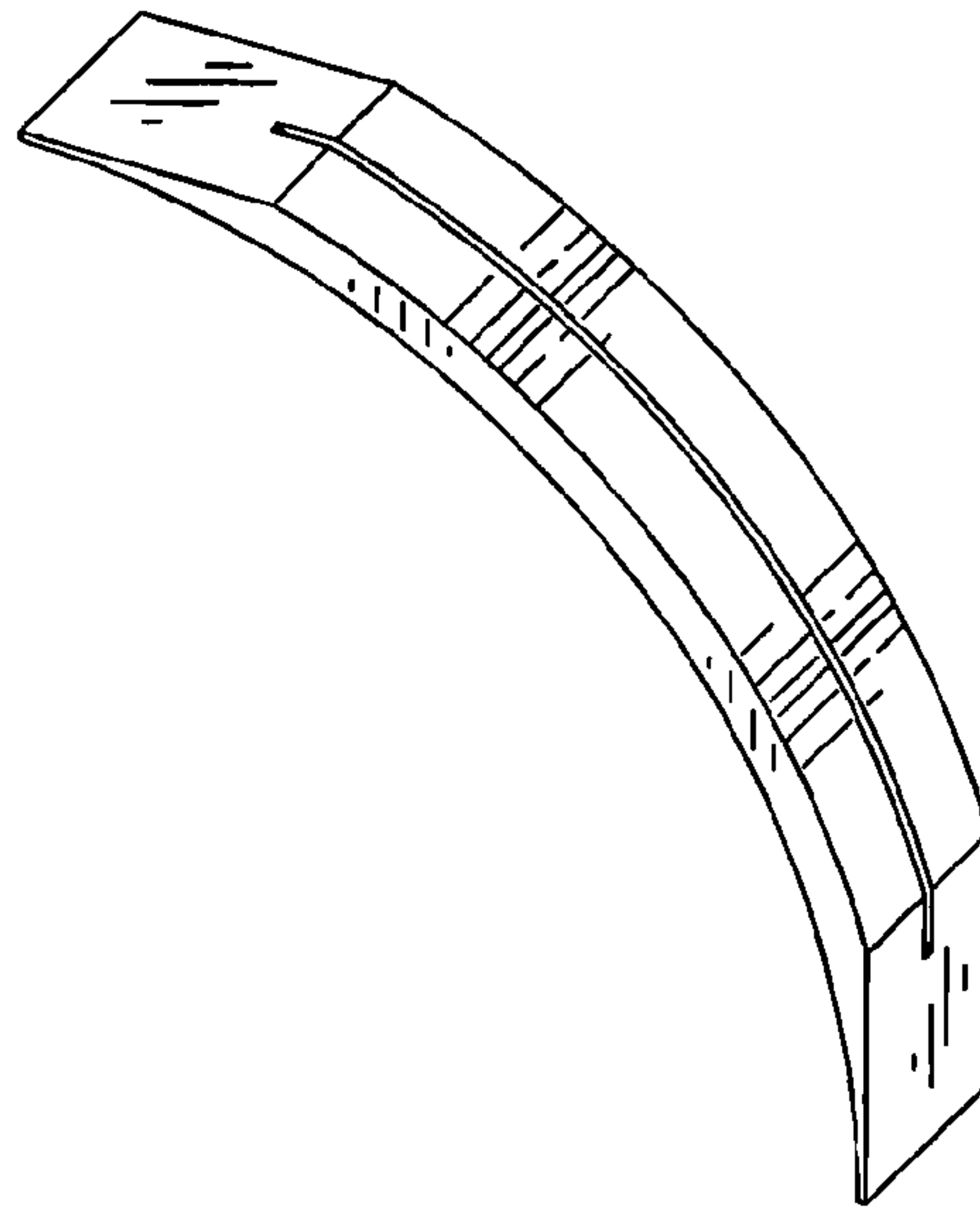

FIG. 2

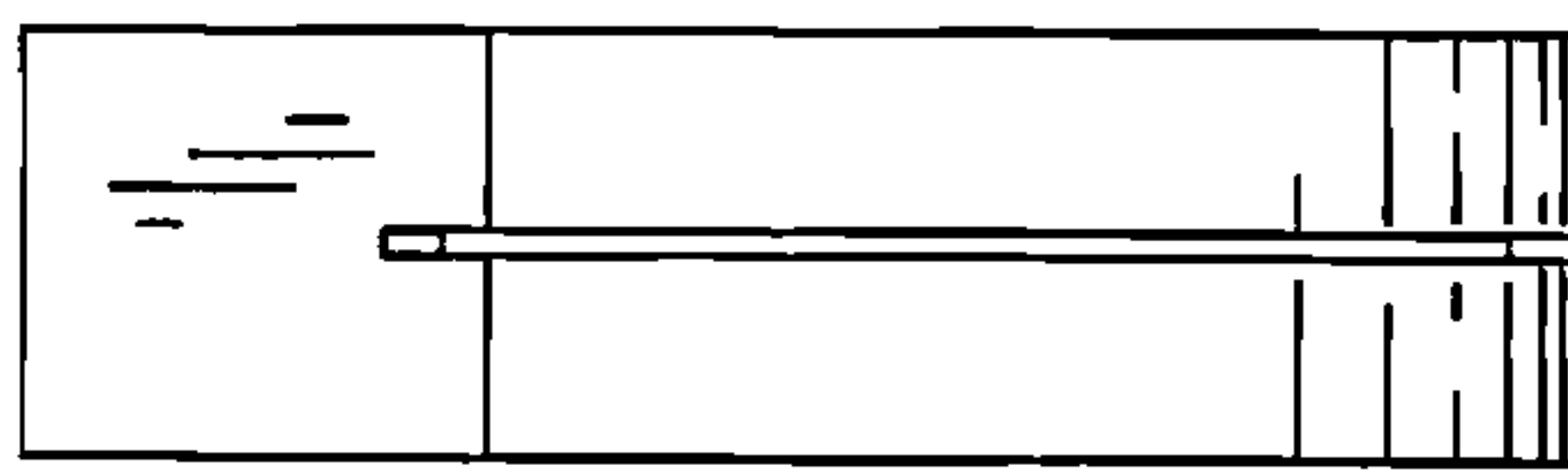

FIG. 3

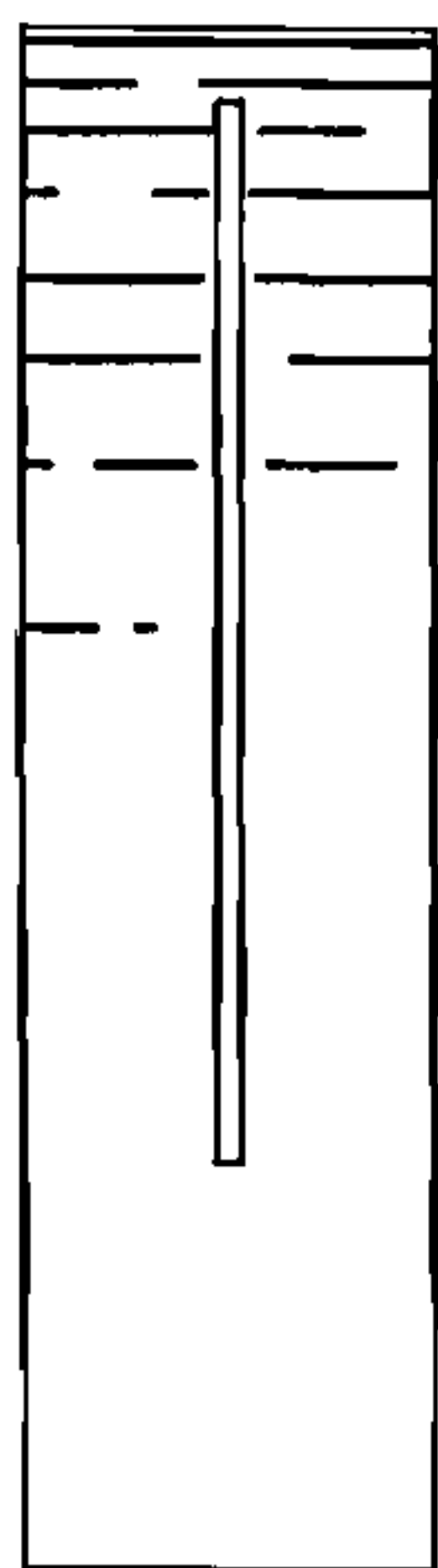

FIG. 4

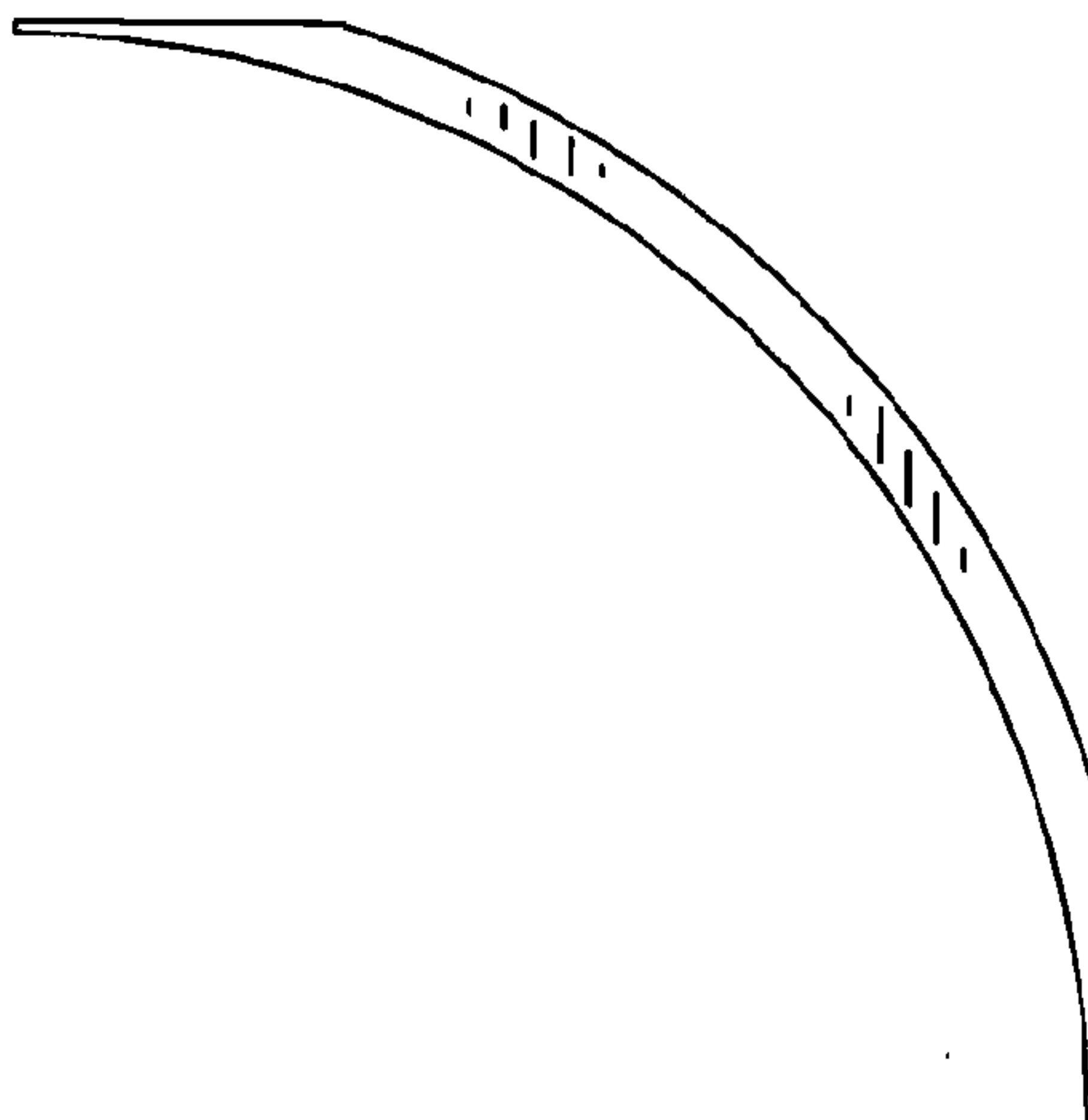

FIG. 5

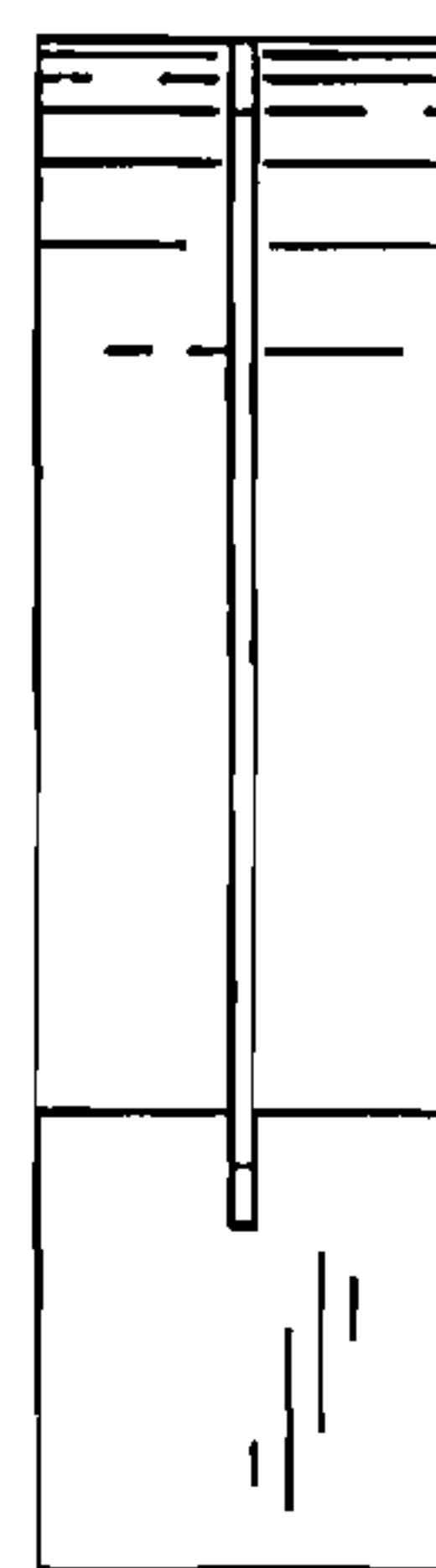

FIG. 6

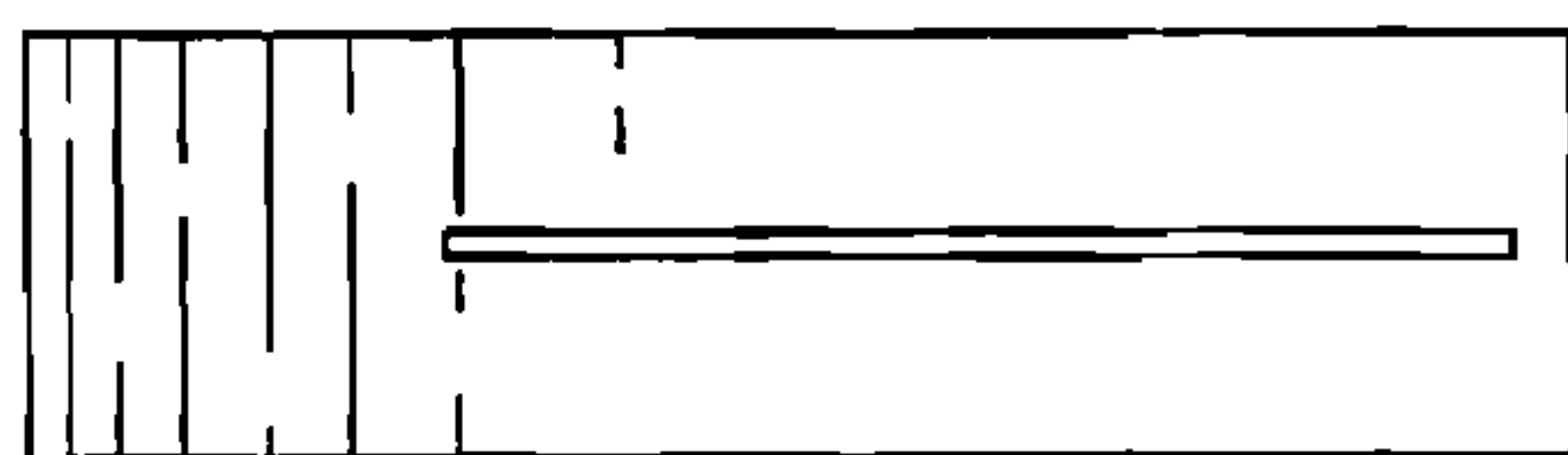

FIG. 7

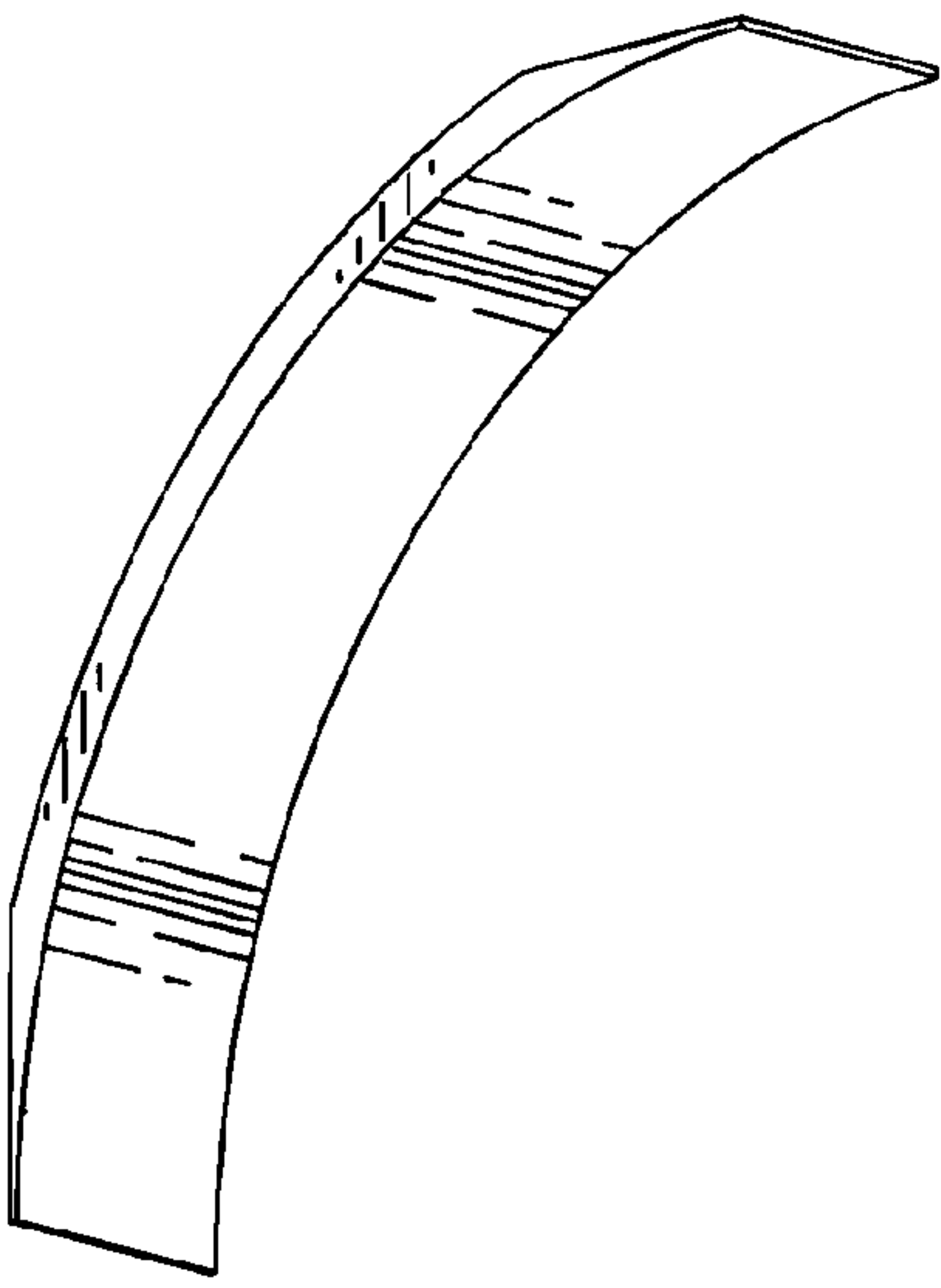

FIG. 8

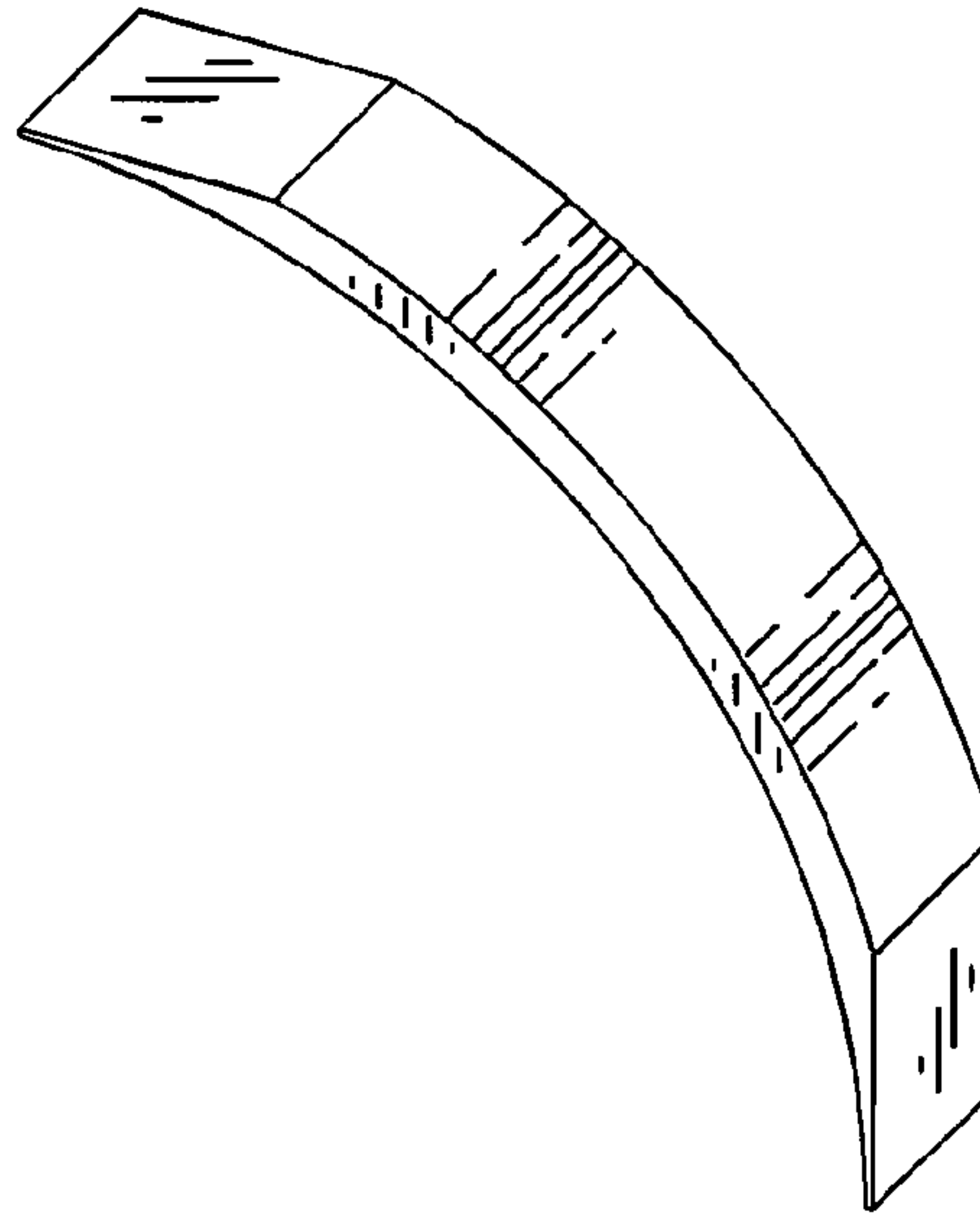

FIG. 9

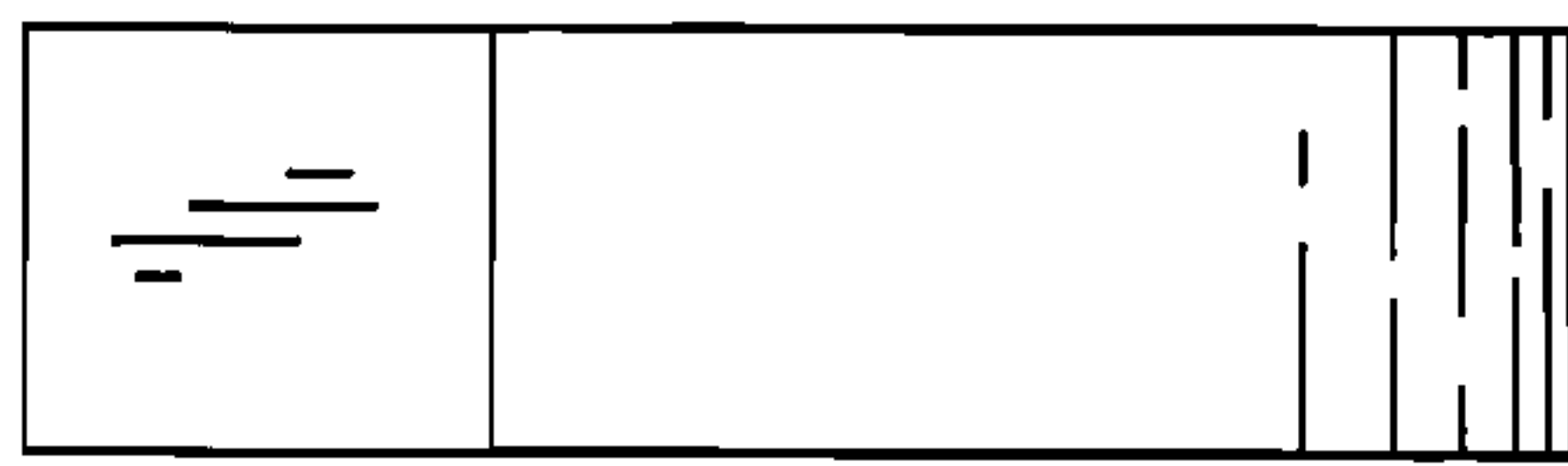

FIG. 10

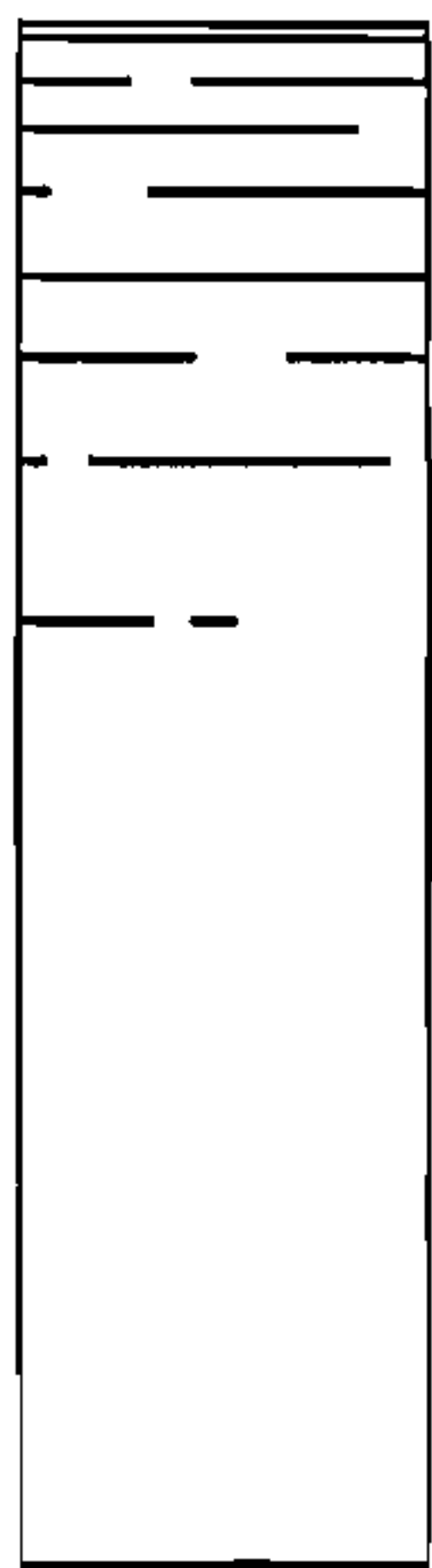

FIG. 11

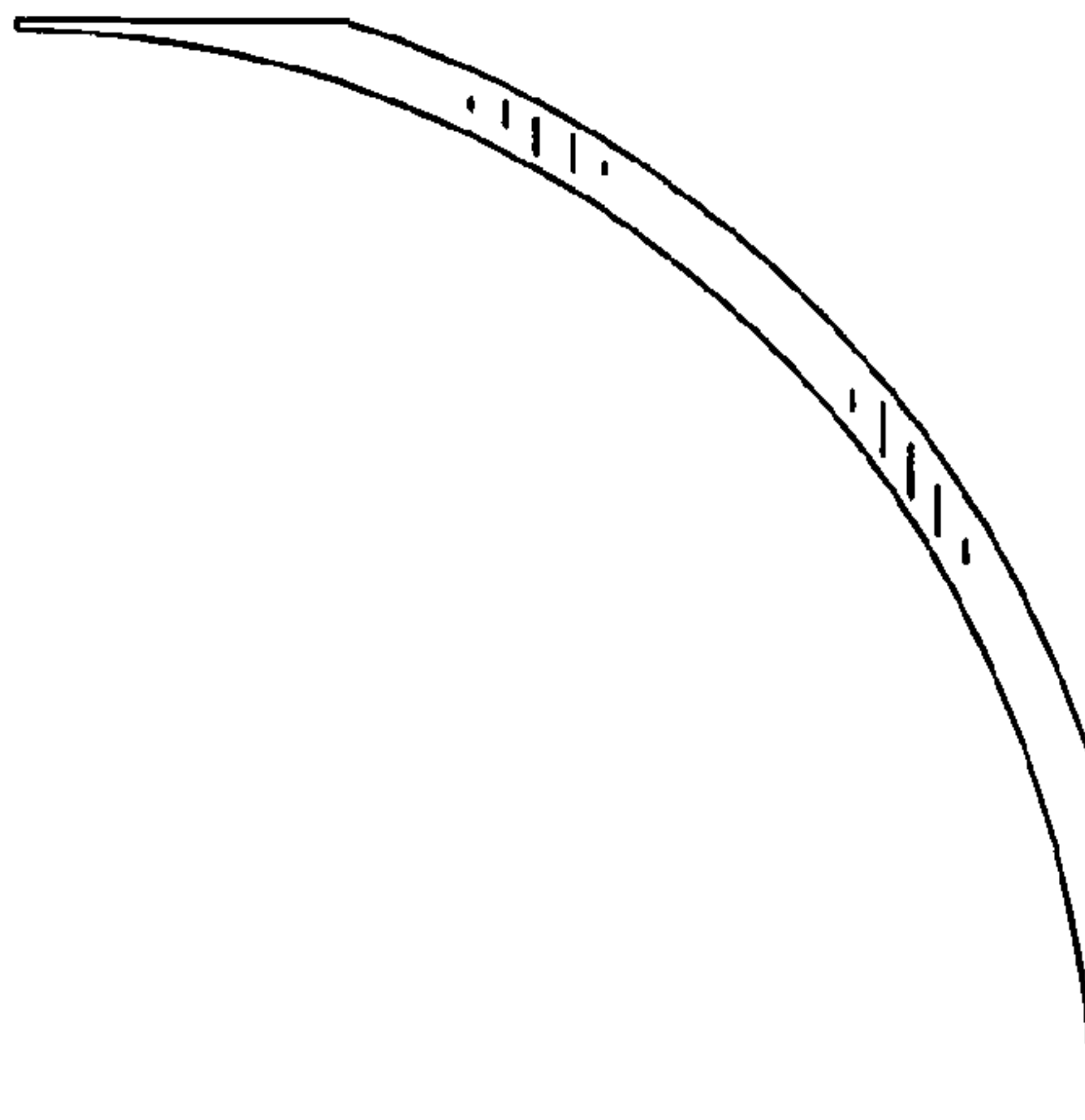

FIG. 12

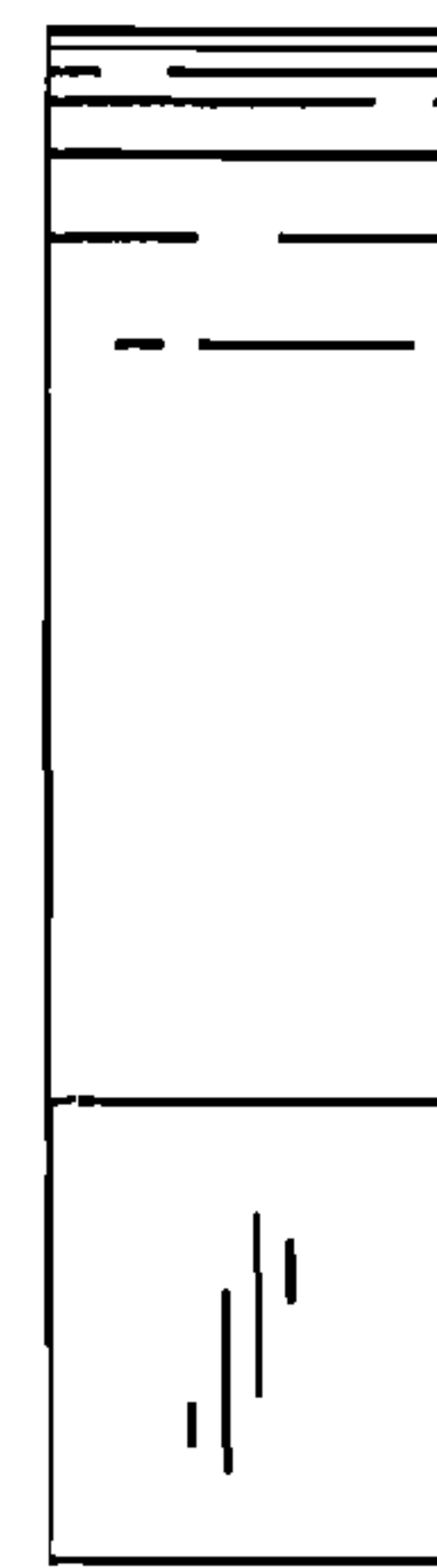

FIG. 13

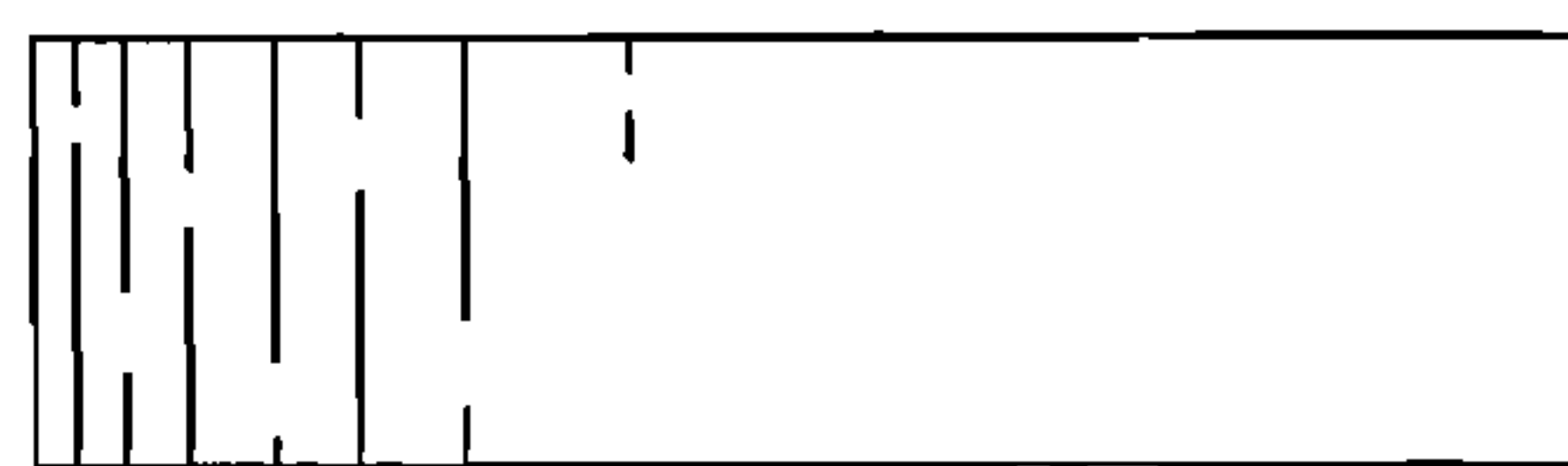

FIG. 14

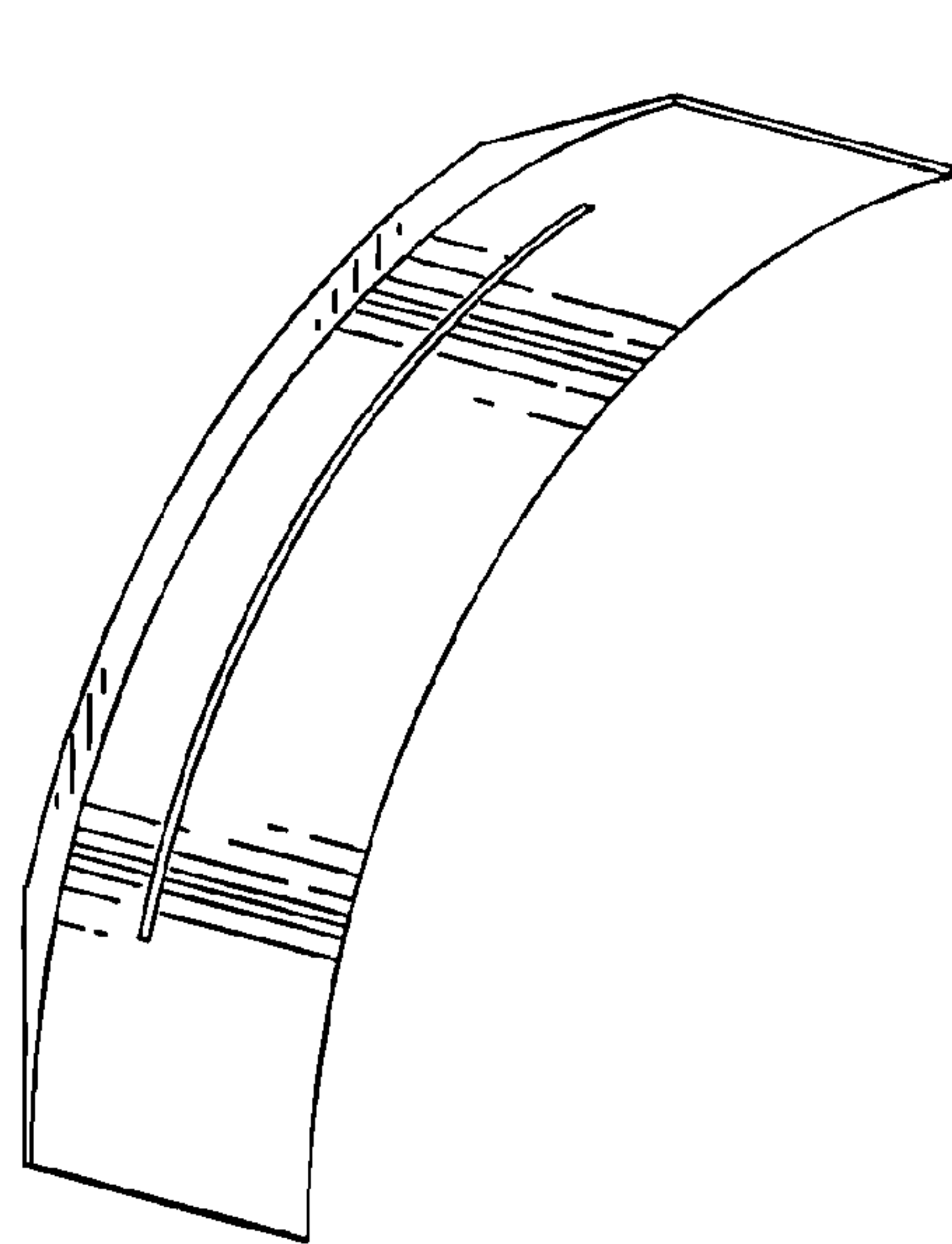

FIG. 15

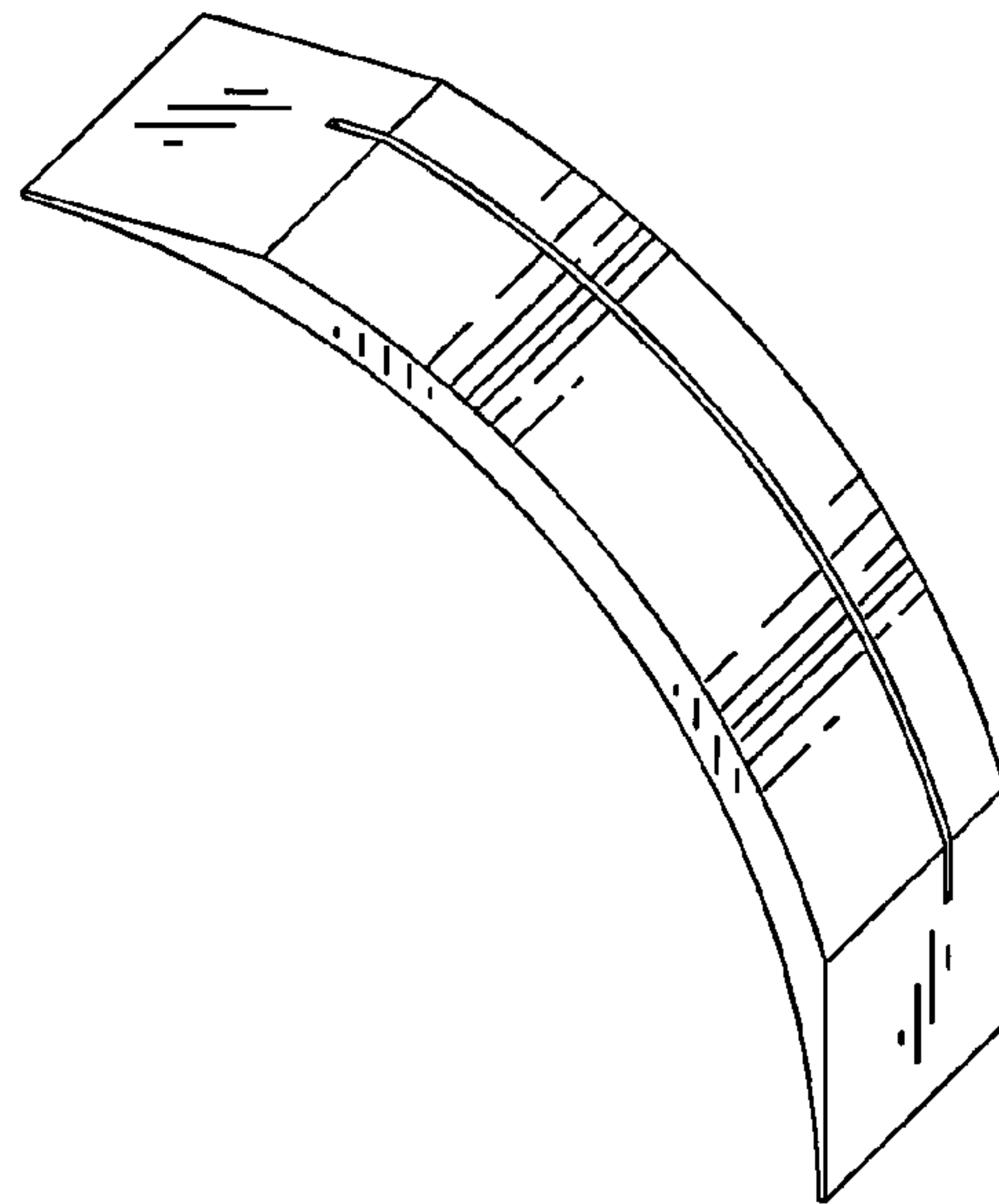

FIG. 16

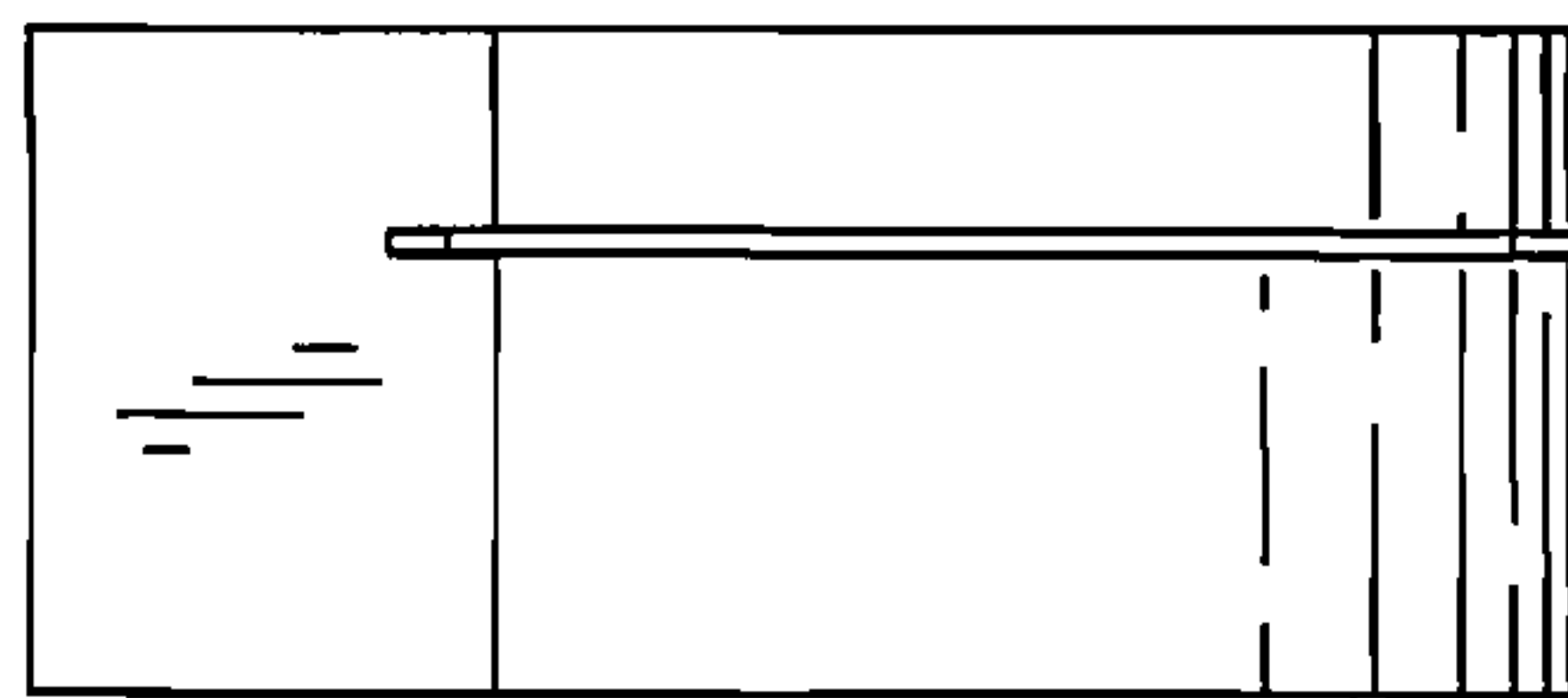

FIG. 17

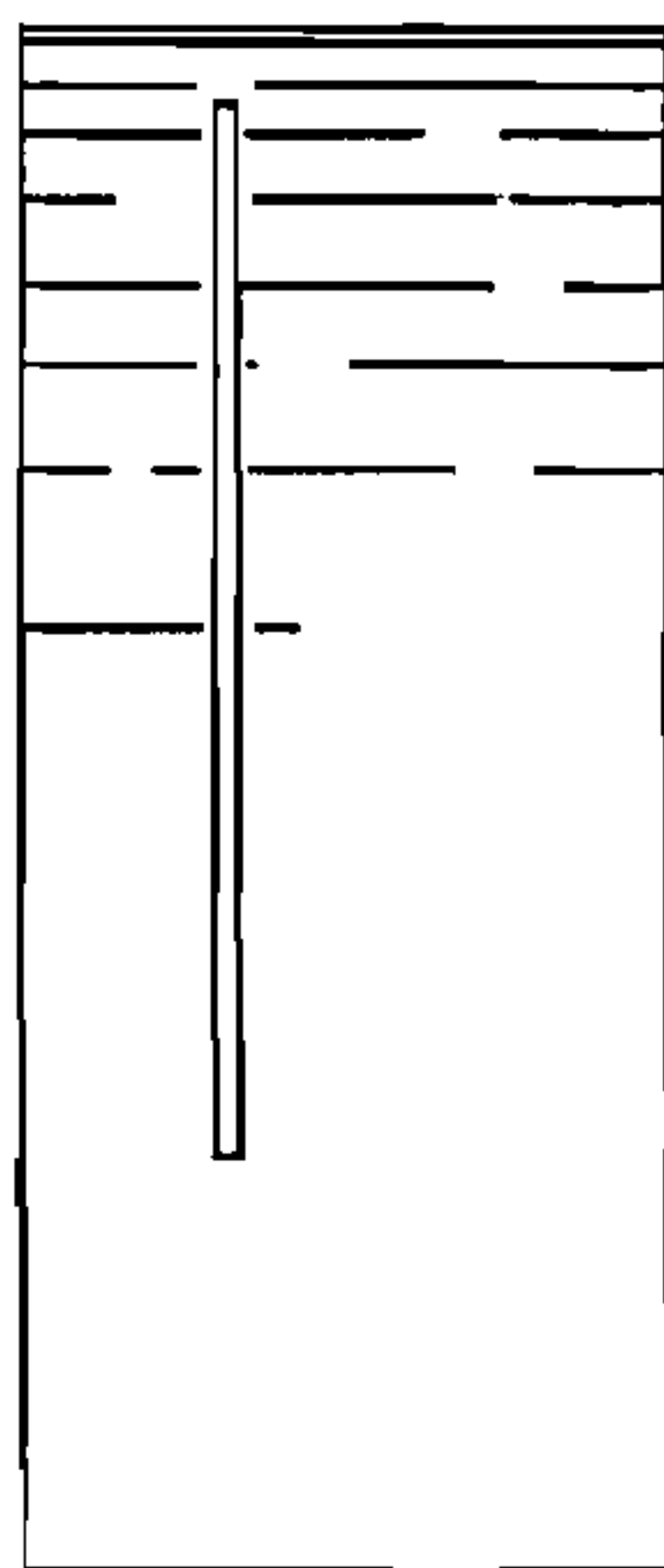

FIG. 18

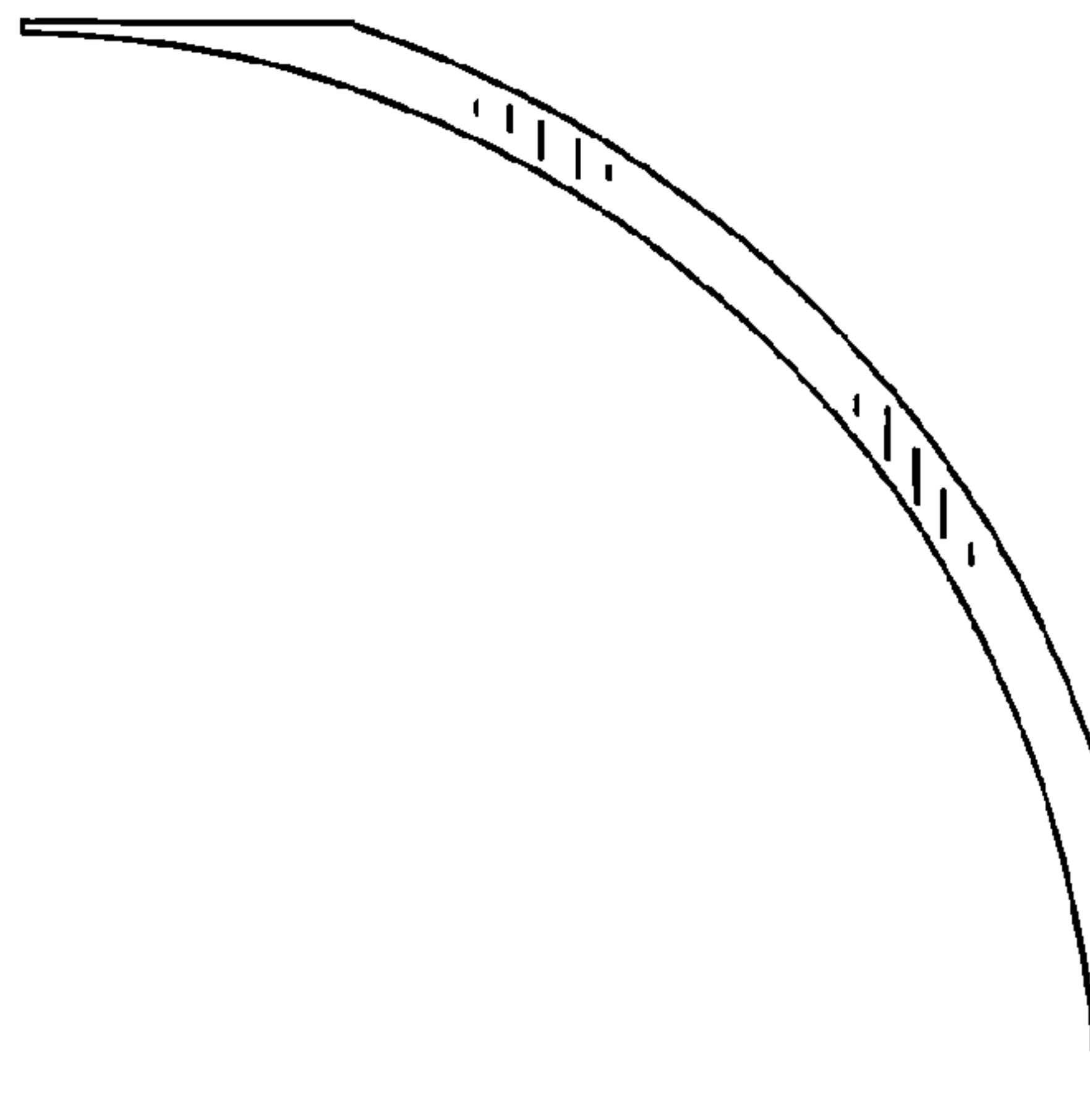

FIG. 19

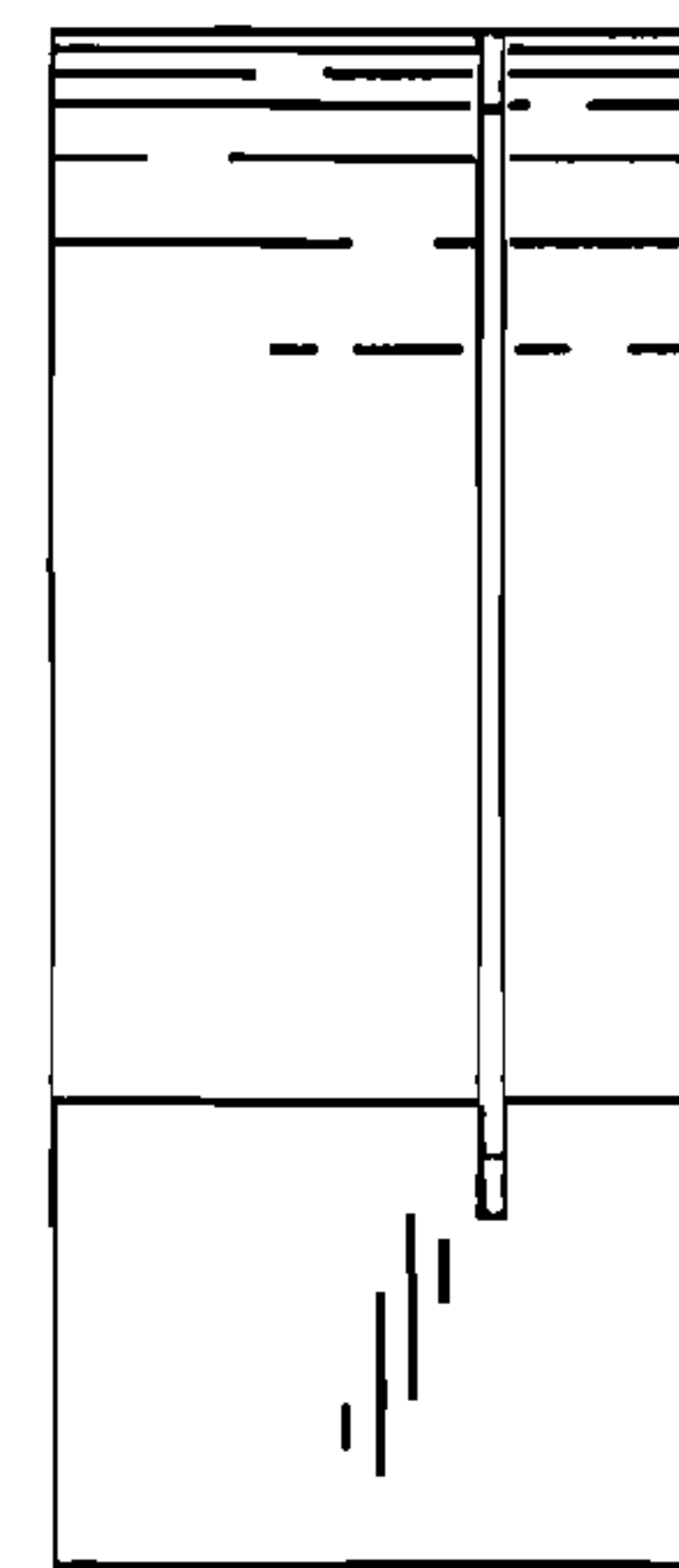

FIG. 20

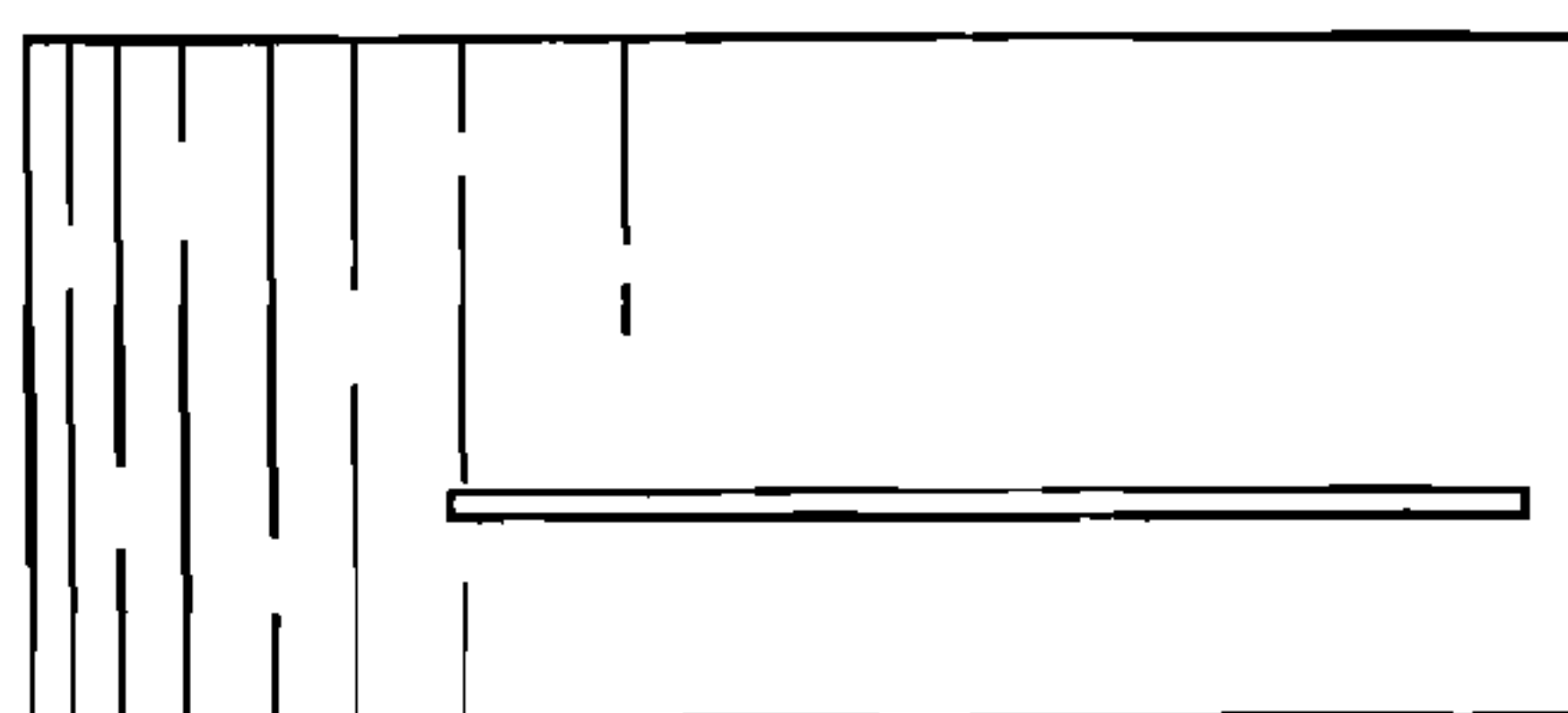

FIG. 21

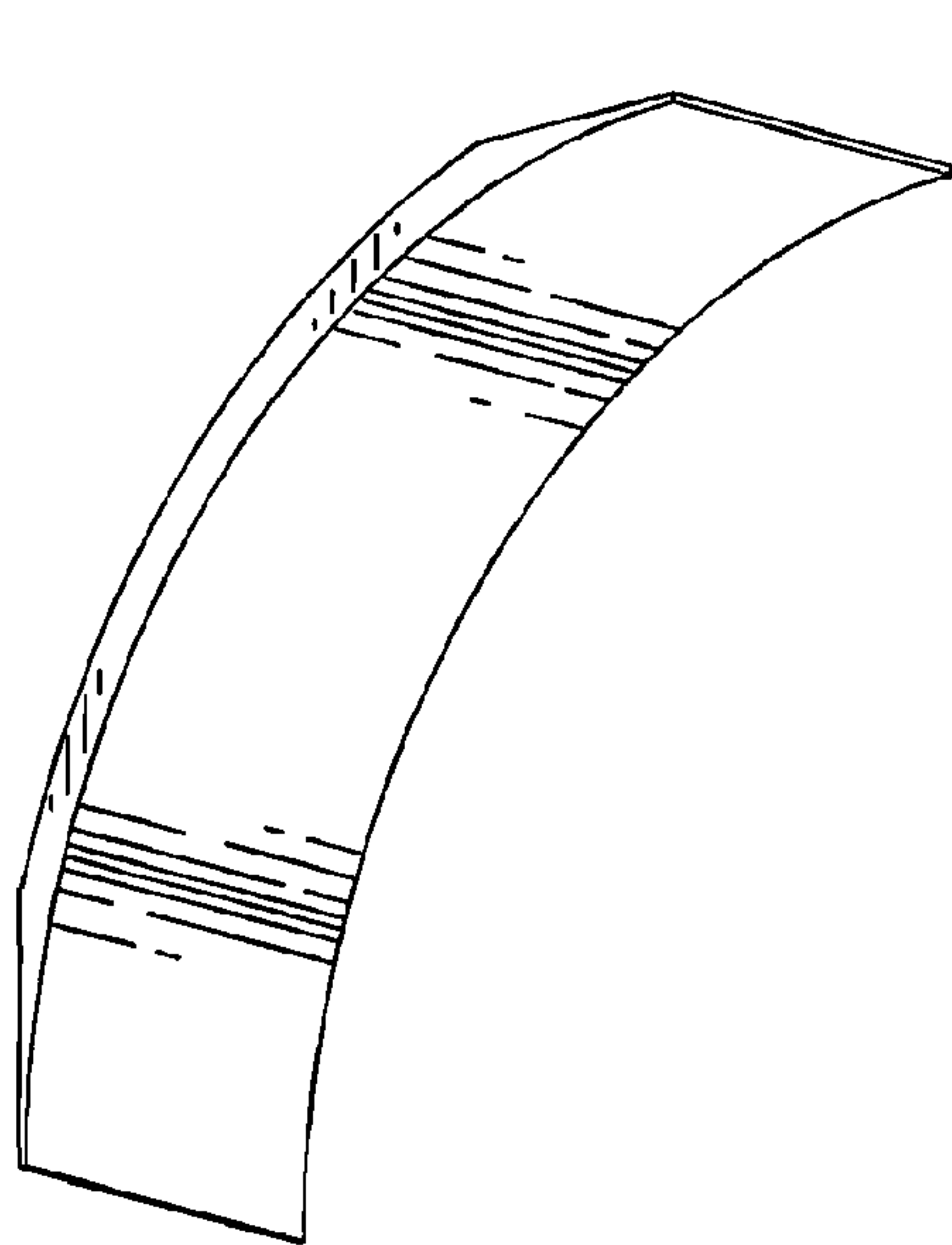

FIG. 22

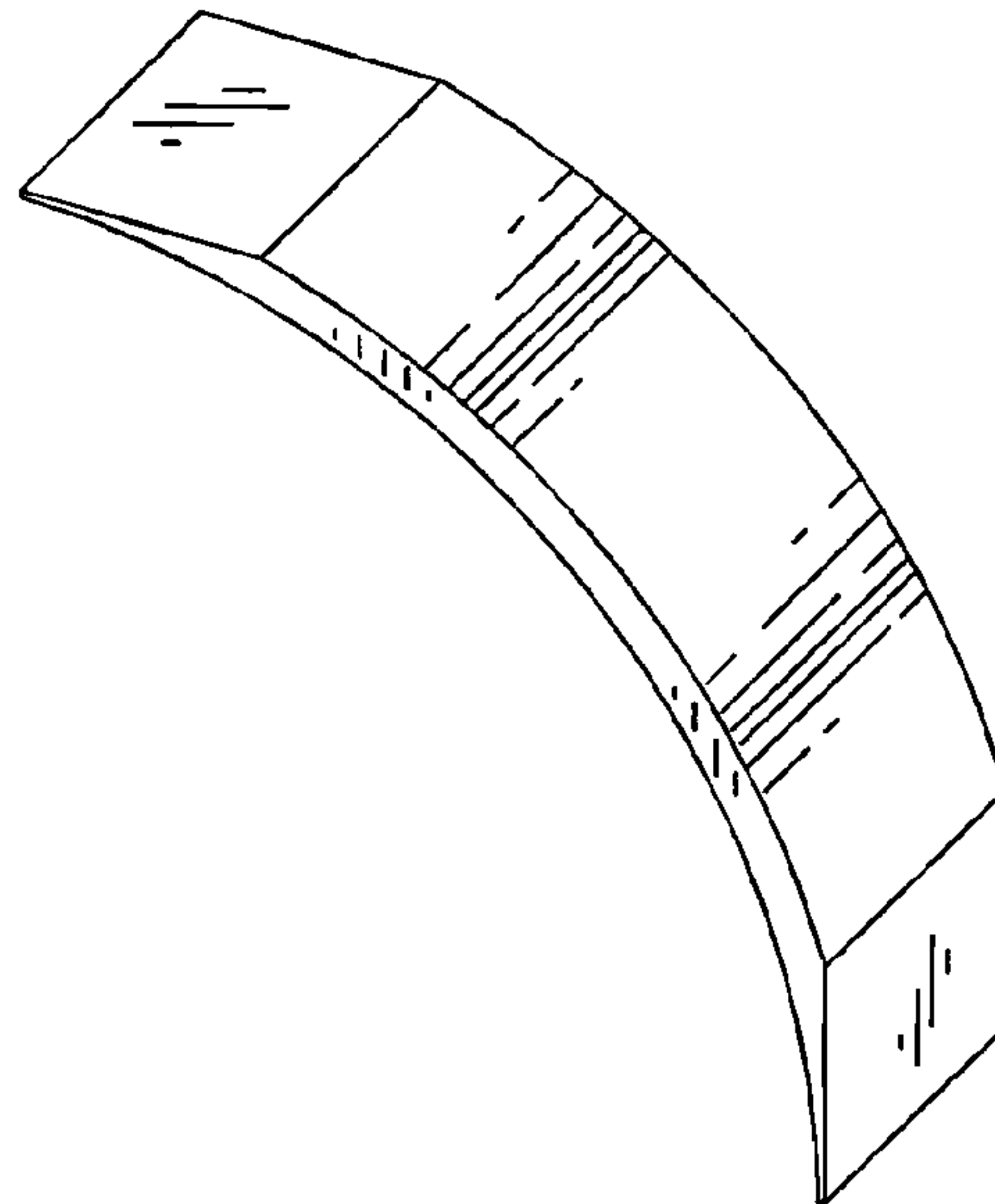

FIG. 23

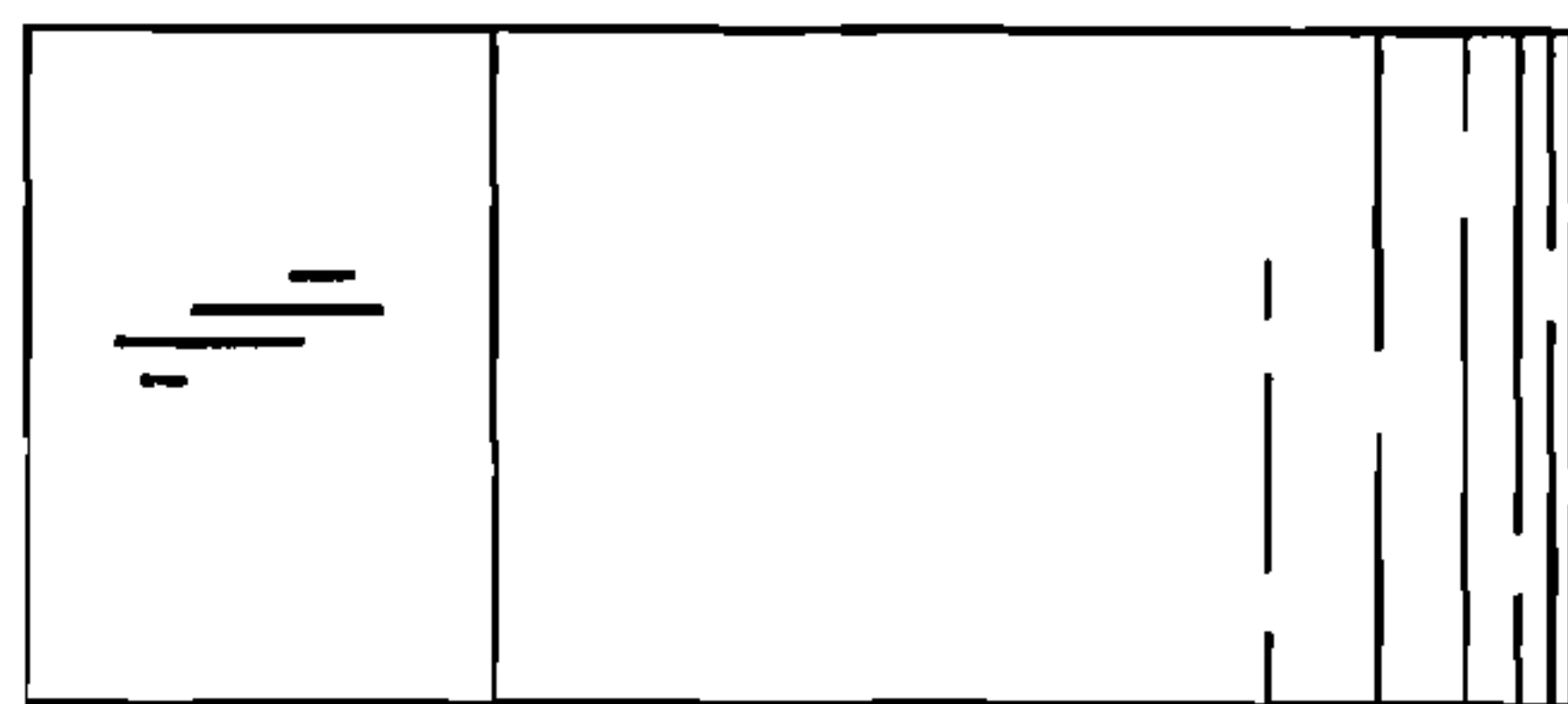

FIG. 24

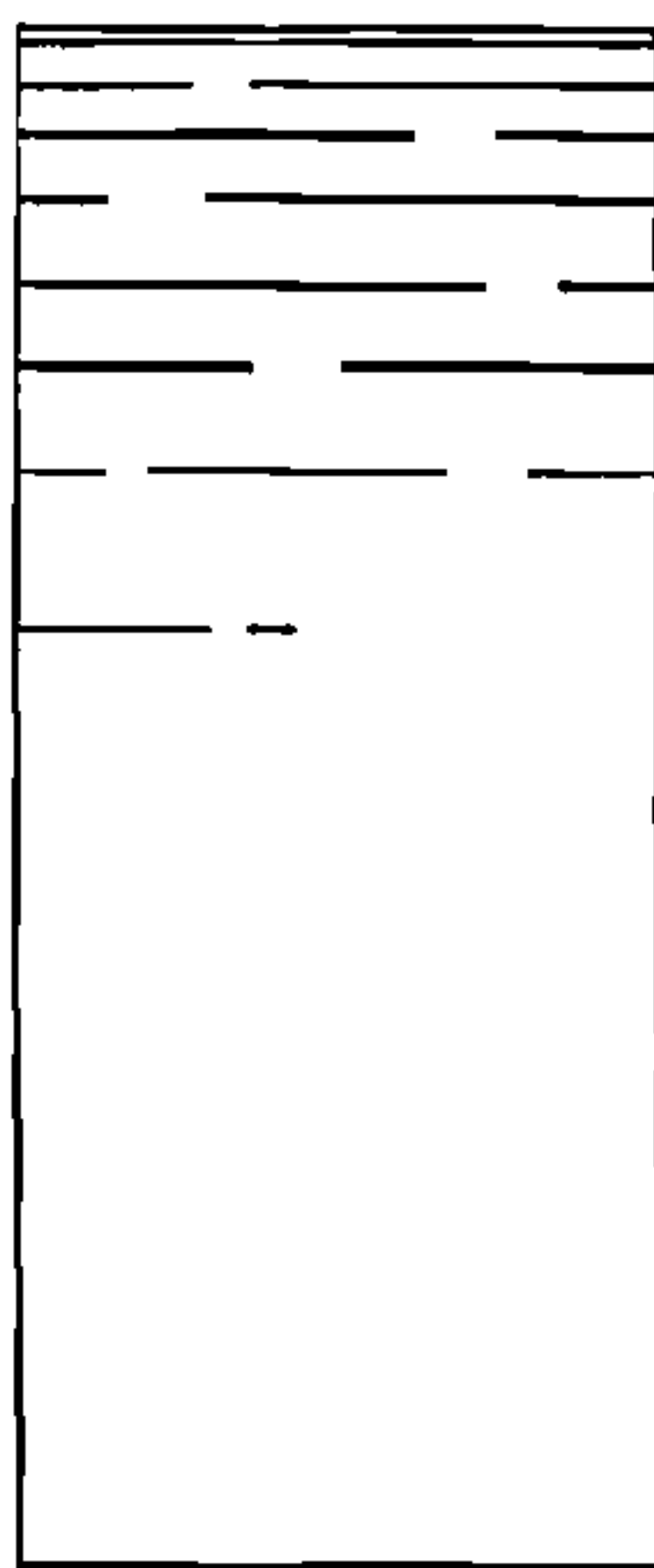

FIG. 25

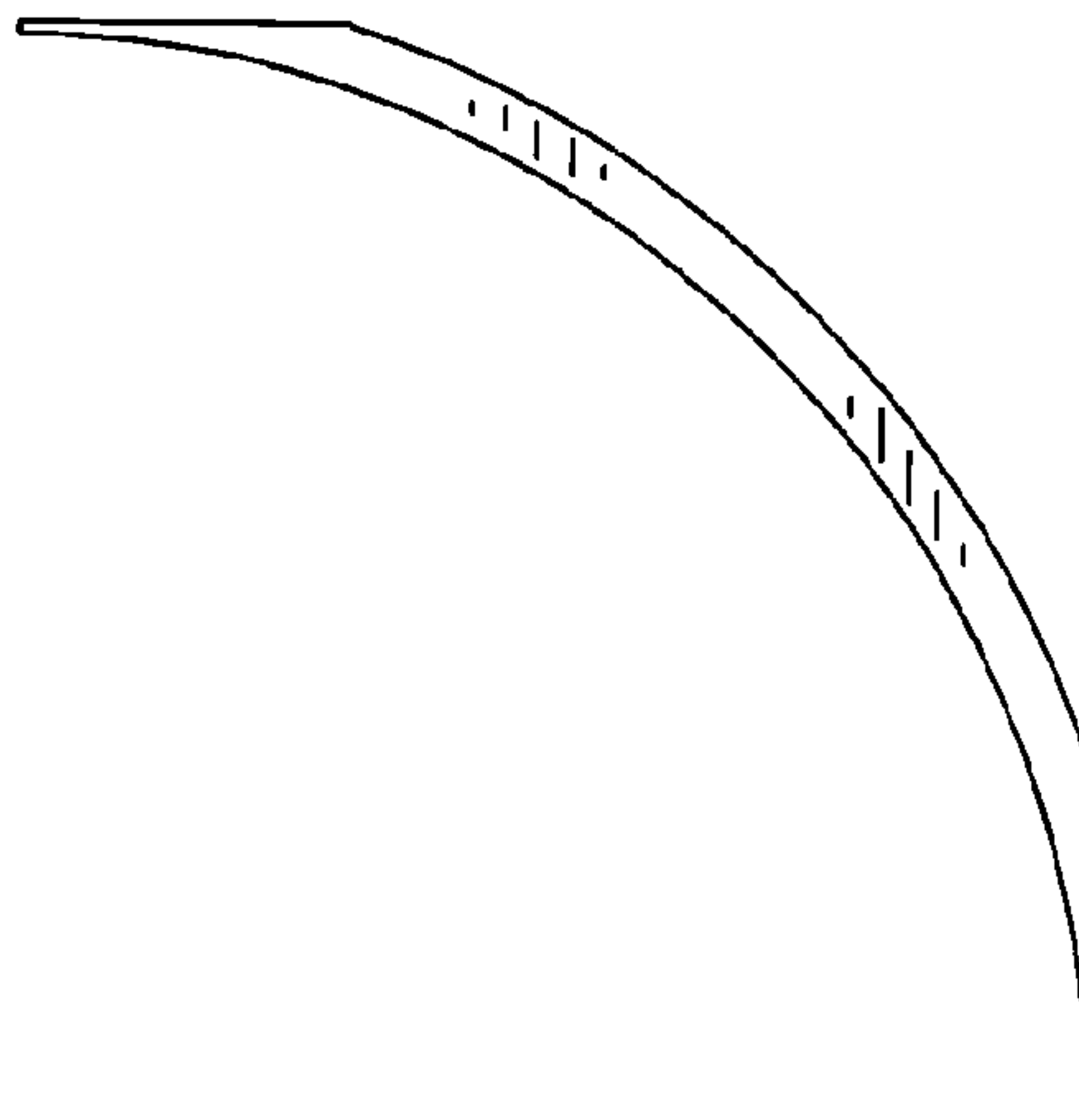

FIG. 26

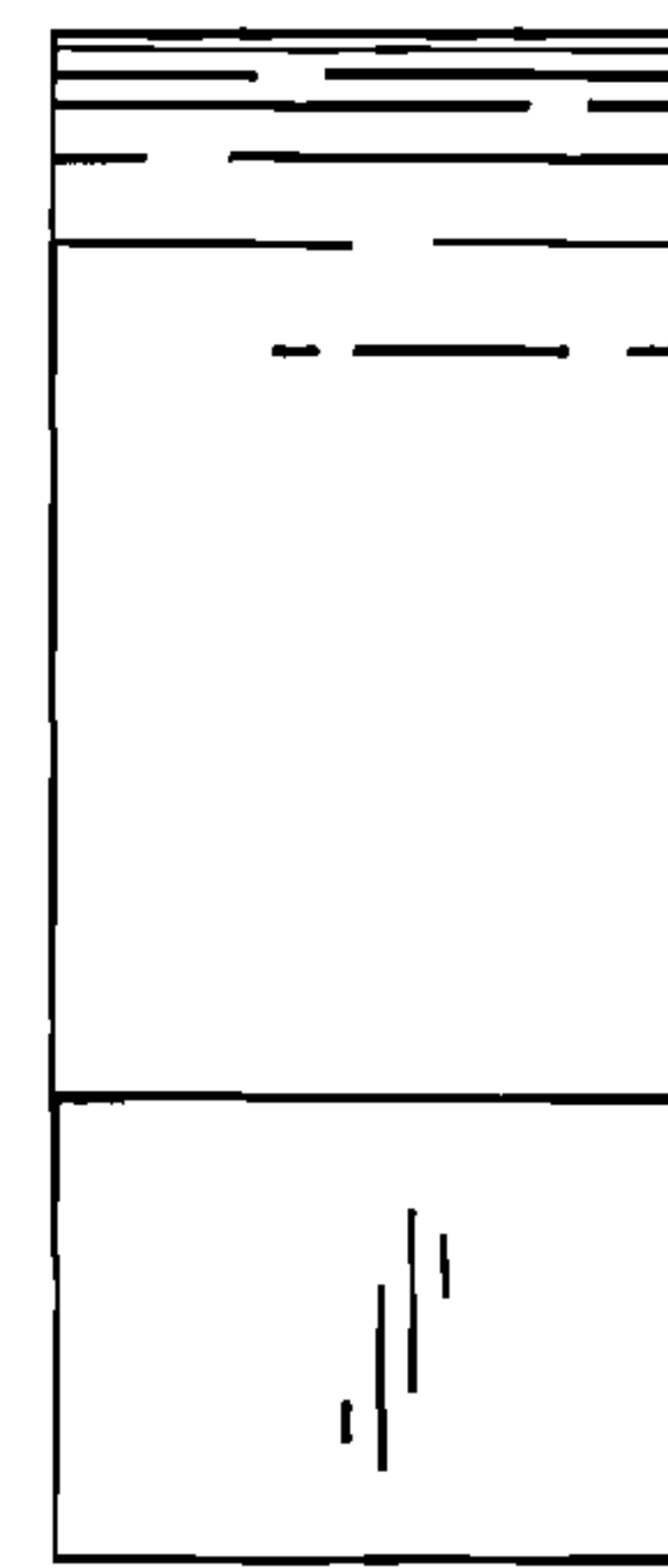

FIG. 27

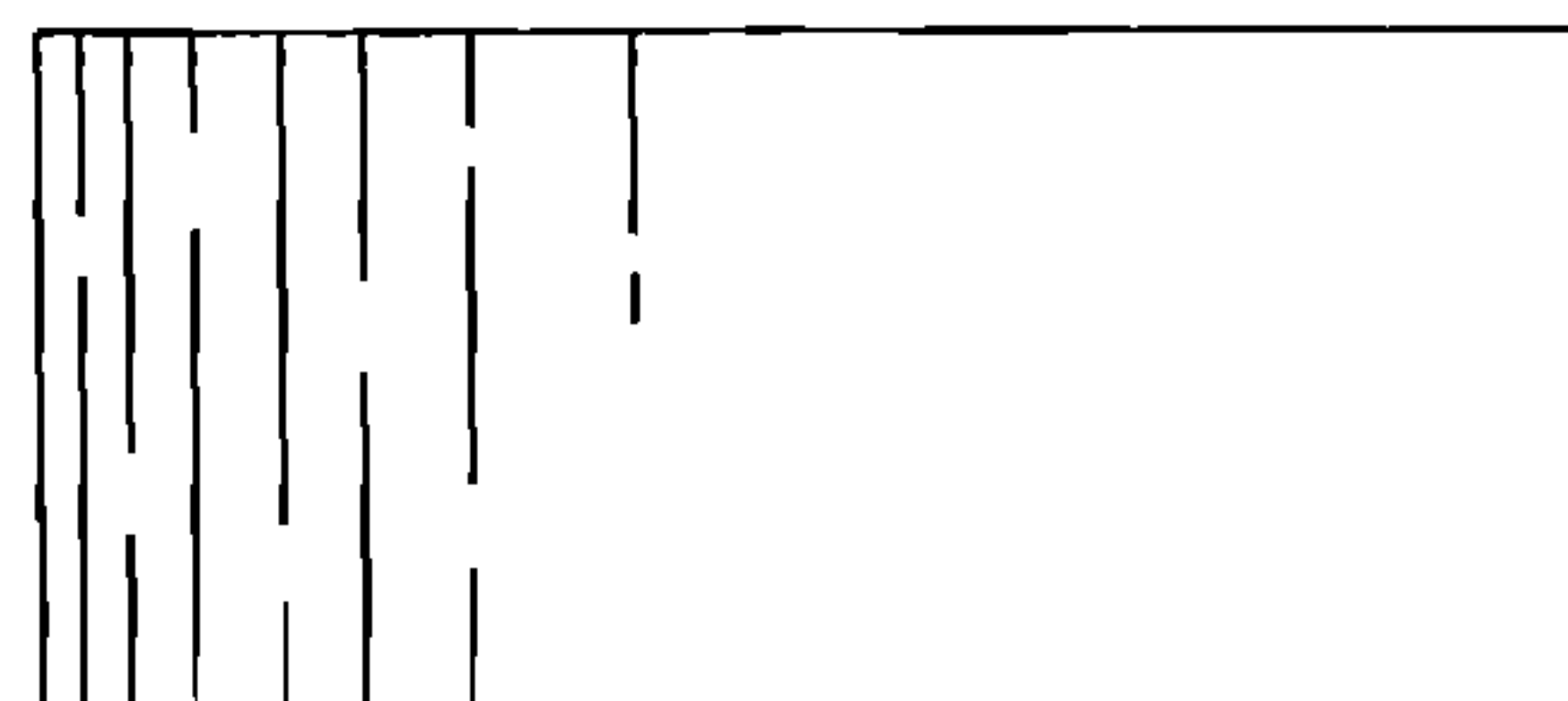

FIG. 28

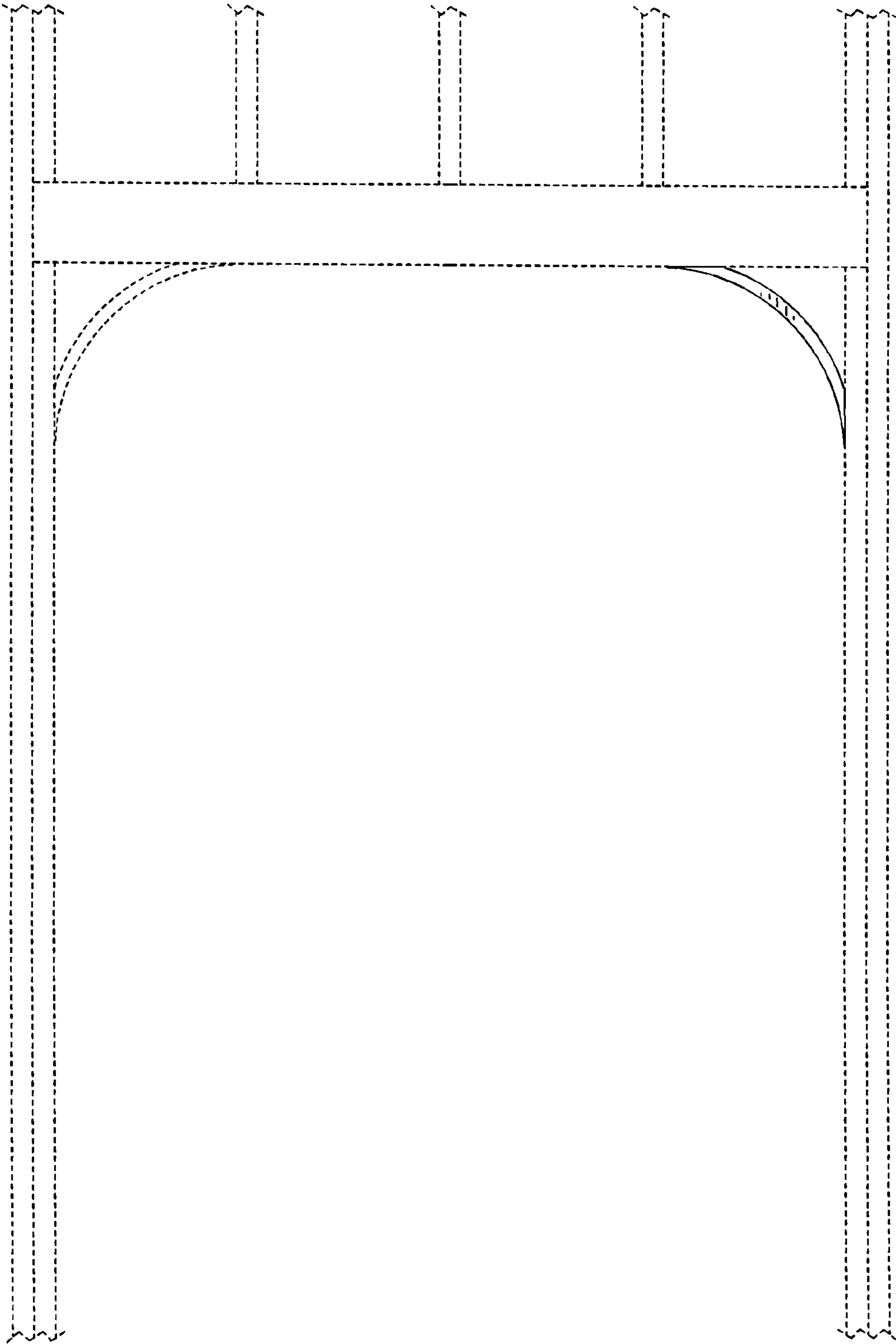

FIG. 29