



US00D683004S

(12) **United States Design Patent**  
**Chouji**

(10) **Patent No.:** **US D683,004 S**

(45) **Date of Patent:** **\*\* May 21, 2013**

(54) **AIR-CONDITIONER**

(75) Inventor: **Masahiko Chouji**, Kusatsu (JP)

(73) Assignee: **Daikin Industries Ltd.**, Osaka-Shi (JP)

(\*\*) Term: **14 Years**

(21) Appl. No.: **29/371,913**

(22) Filed: **Jan. 19, 2012**

(30) **Foreign Application Priority Data**

Aug. 11, 2011 (JP) ..... 2011-018420

(51) **LOC (9) Cl.** ..... **23-04**

(52) **U.S. Cl.**  
USPC ..... **D23/351**

(58) **Field of Classification Search** ..... D23/351-354,  
D23/385, 355, 357, 361; 312/236; 62/259.1,  
62/259.4, 262-263, 304; 454/330-331, 349-350  
See application file for complete search history.

(56) **References Cited**

**U.S. PATENT DOCUMENTS**

D529,158 S *	9/2006	Ueno et al. ....	D23/351
D564,081 S *	3/2008	Yamamoto .....	D23/351
D579,095 S *	10/2008	Nagahori et al. ....	D23/351
D580,534 S *	11/2008	Oh et al. ....	D23/351
D581,504 S *	11/2008	Nakamura et al. ....	D23/351
D584,806 S *	1/2009	Oh et al. ....	D23/351
D605,266 S *	12/2009	Nakamura et al. ....	D23/351
D605,267 S *	12/2009	Nakamura et al. ....	D23/351
D613,384 S *	4/2010	Ohta .....	D23/351
D621,018 S *	8/2010	Nagahori et al. ....	D23/351

D624,168 S *	9/2010	Aketa et al. ....	D23/351
D632,769 S *	2/2011	Seki .....	D23/351
D641,847 S *	7/2011	Seki .....	D23/351
D642,249 S *	7/2011	Seki .....	D23/351
D642,250 S *	7/2011	Chouji .....	D23/351
D648,015 S *	11/2011	Baek et al. ....	D23/351
D657,035 S *	4/2012	Chouji .....	D23/351
D667,095 S *	9/2012	Yamana et al. ....	D23/351
D669,567 S *	10/2012	Yamana et al. ....	D23/351
D674,068 S *	1/2013	Baek et al. ....	D23/351

\* cited by examiner

*Primary Examiner* — Brian N Vinson

(74) *Attorney, Agent, or Firm* — Manabu Kanesaka

(57) **CLAIM**

The ornamental design for an air-conditioner, as shown and described.

**DESCRIPTION**

FIG. 1 is a perspective view of an air-conditioner showing my new design;  
 FIG. 2 is another perspective view thereof, wherein the wind directing plate is open;  
 FIG. 3 is a front view thereof;  
 FIG. 4 is a rear view thereof;  
 FIG. 5 is a plan view thereof;  
 FIG. 6 is a bottom view thereof;  
 FIG. 7 is a left side view thereof;  
 FIG. 8 is a right side view thereof; and,  
 FIG. 9 is a cross-sectional view thereof taken along line 9-9 of FIG. 3.

The broken lines depict portions of the air-conditioner that form no part of claimed design.

**1 Claim, 8 Drawing Sheets**

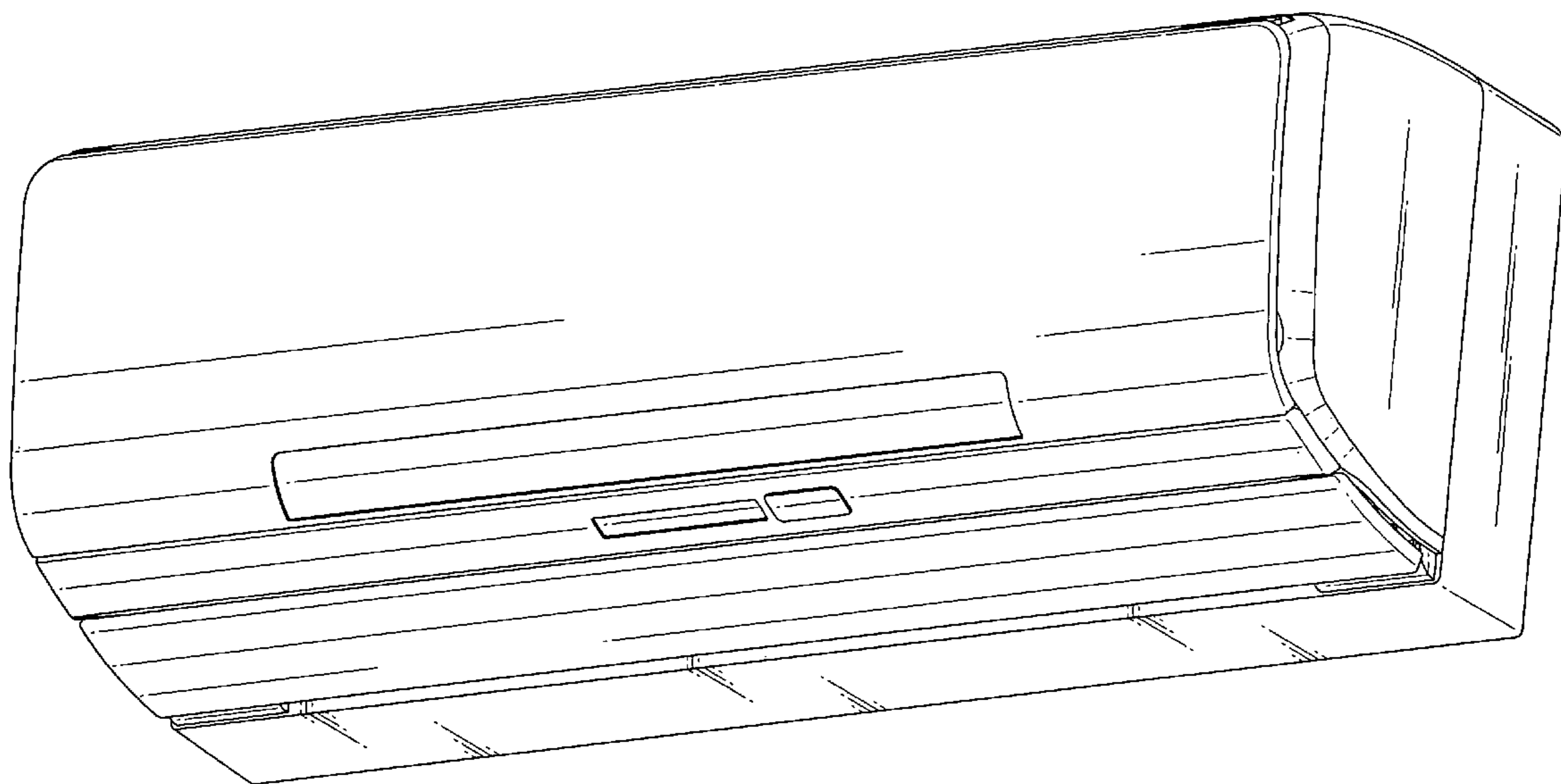

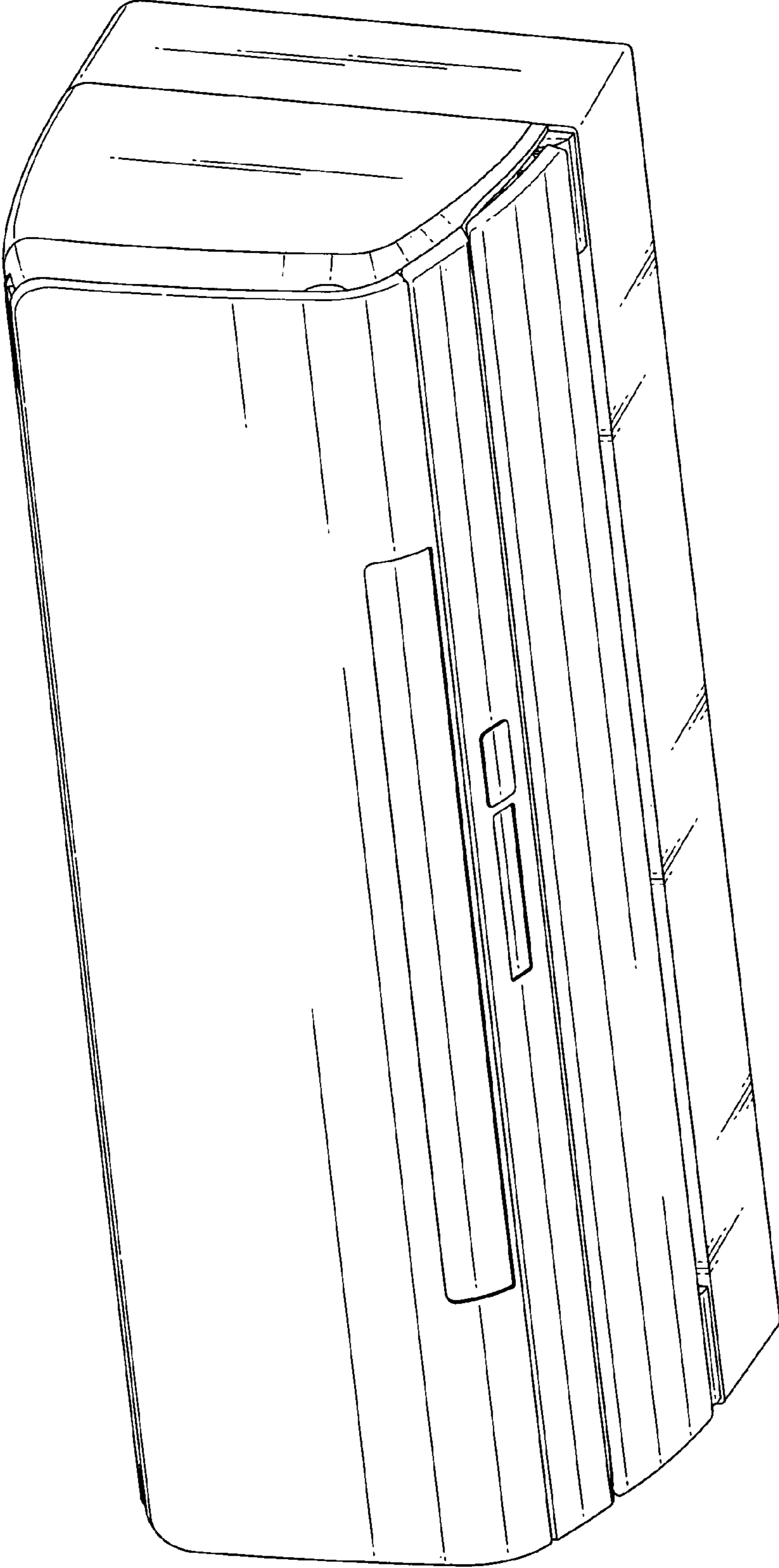

Fig. 1

Fig. 2

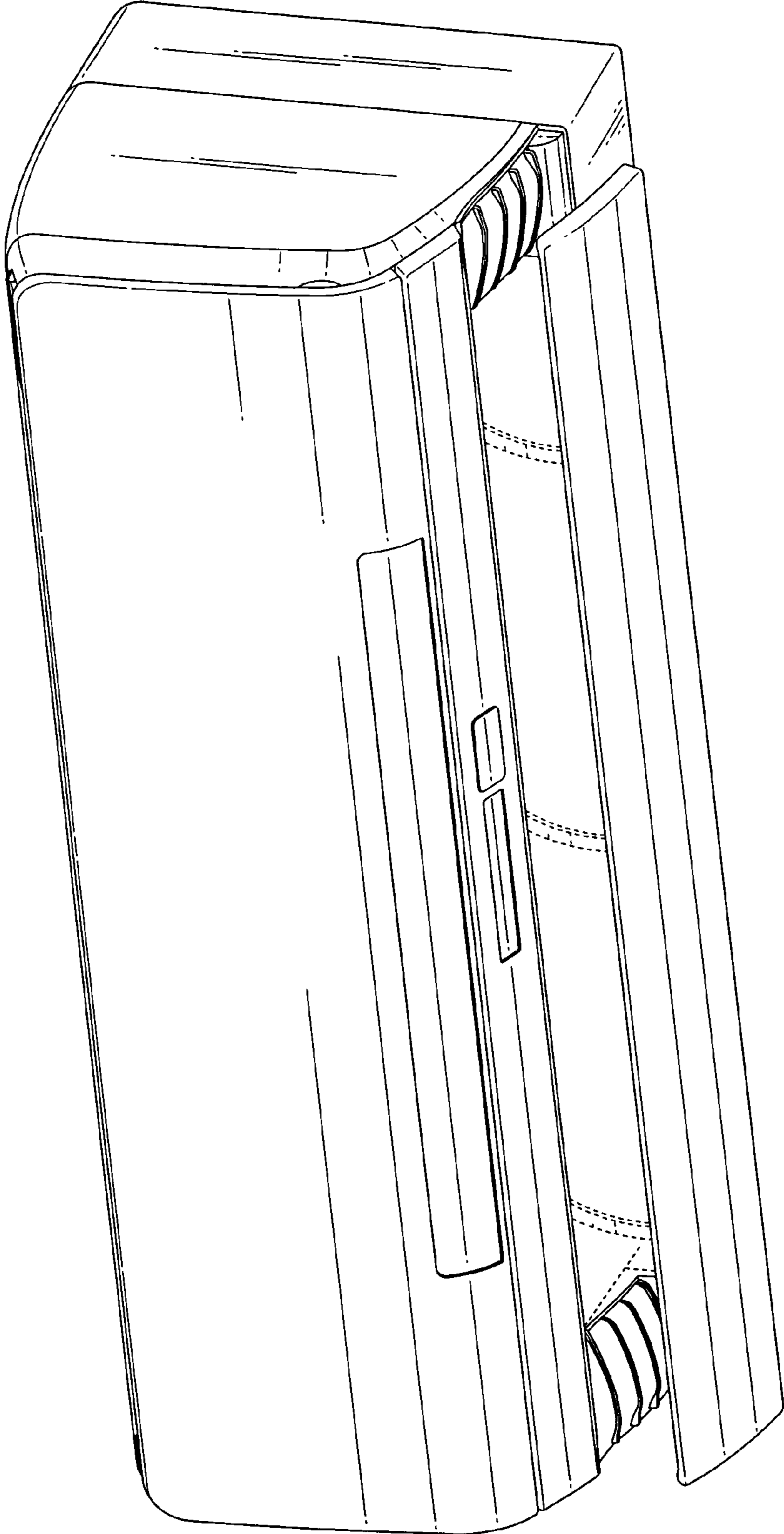
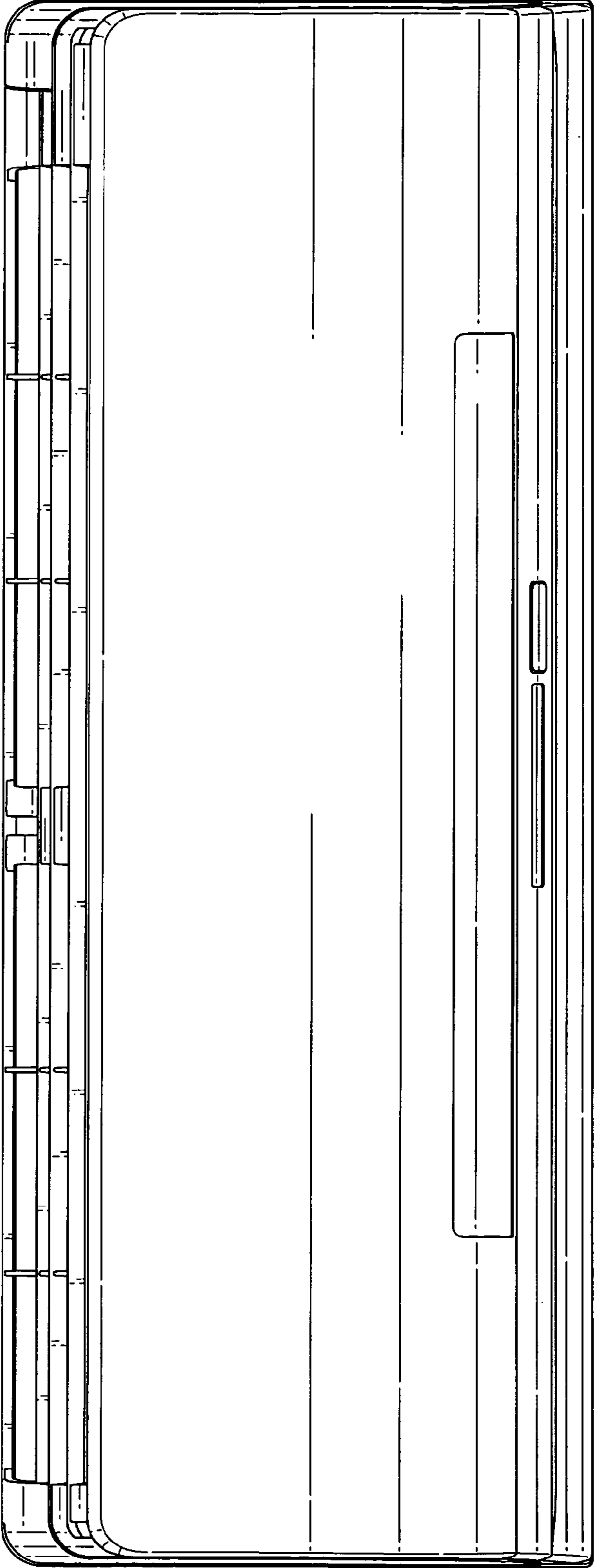

Fig. 3

9 ↗



9 ↘

Fig. 4

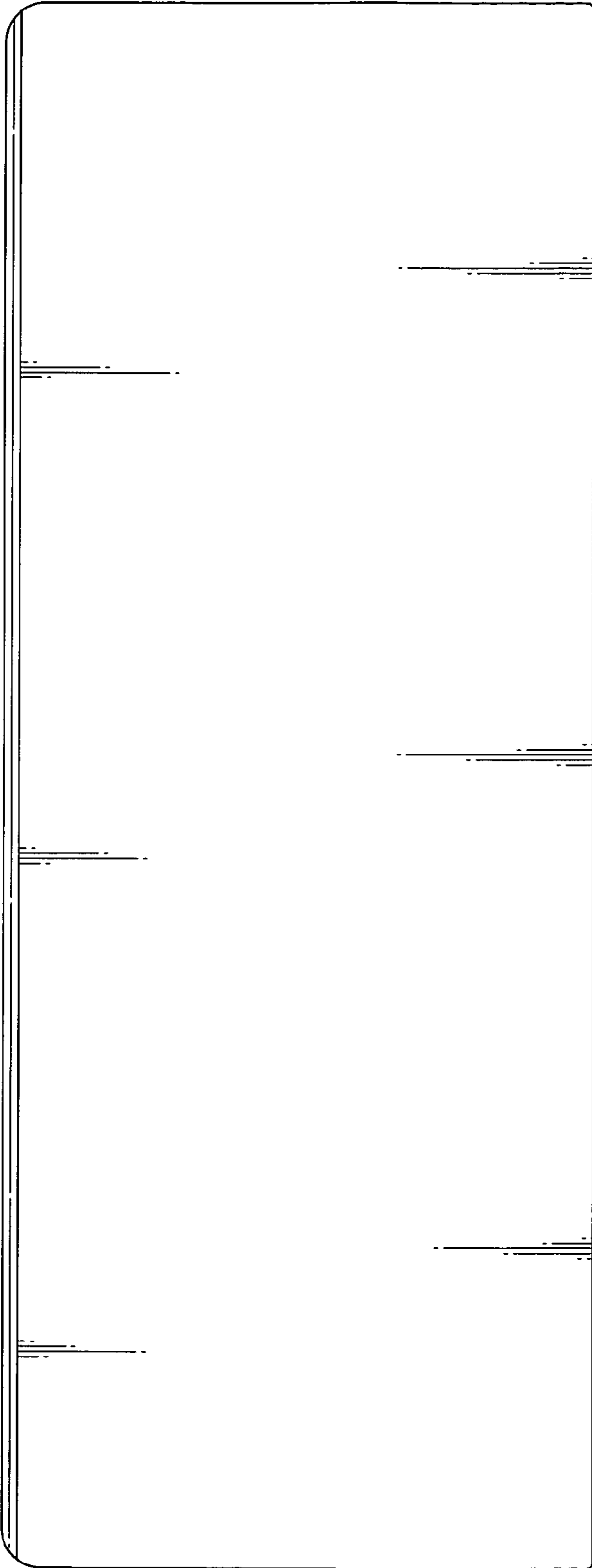

Fig. 5

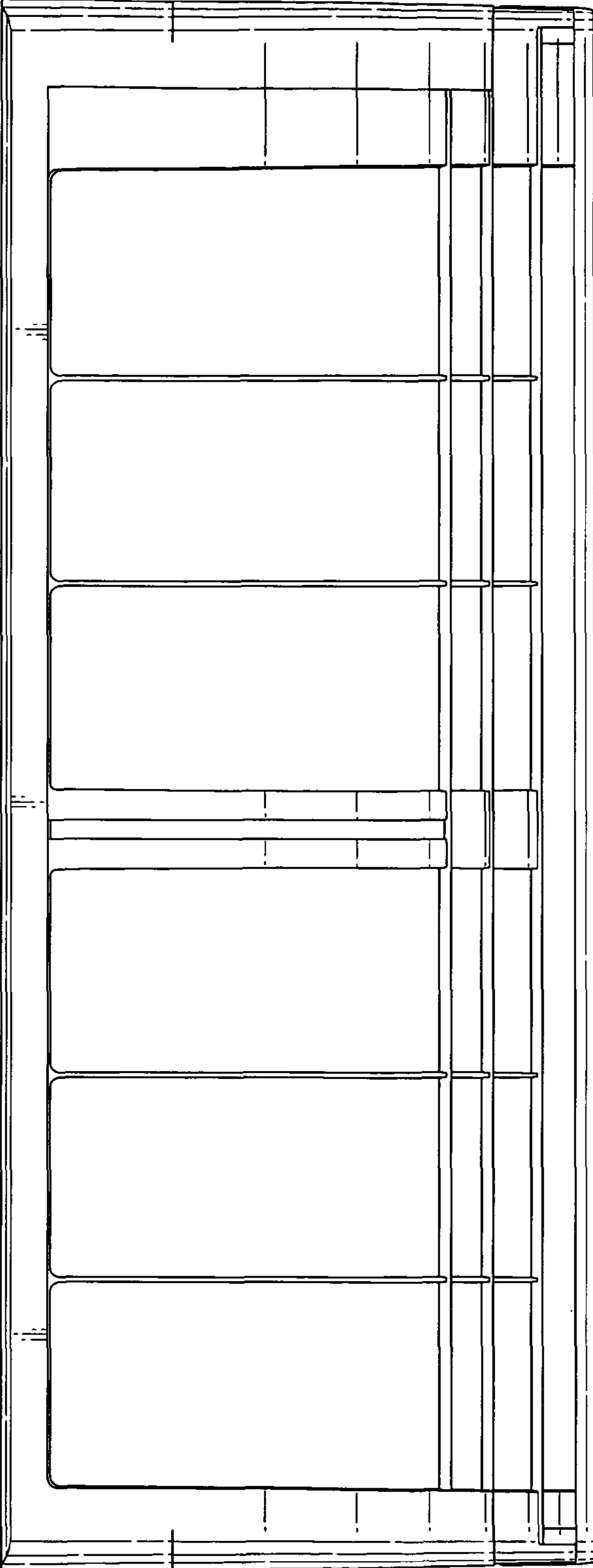

Fig. 6

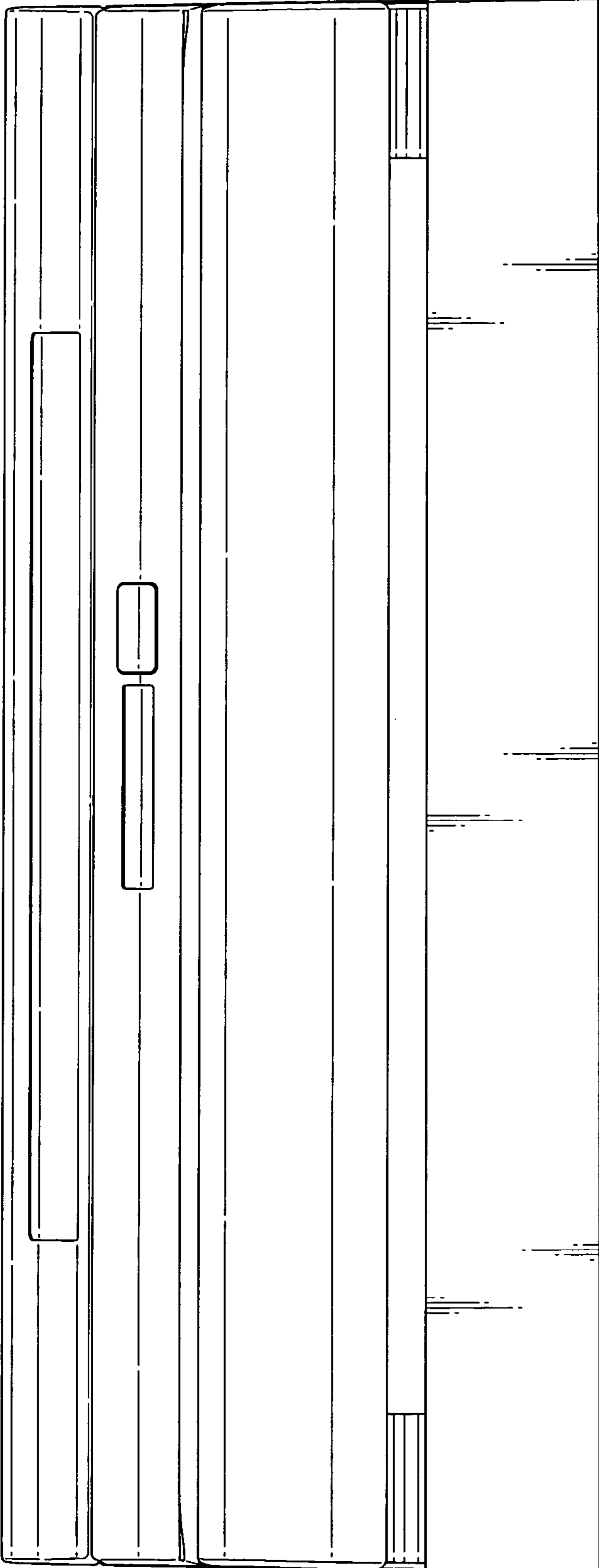

Fig. 8

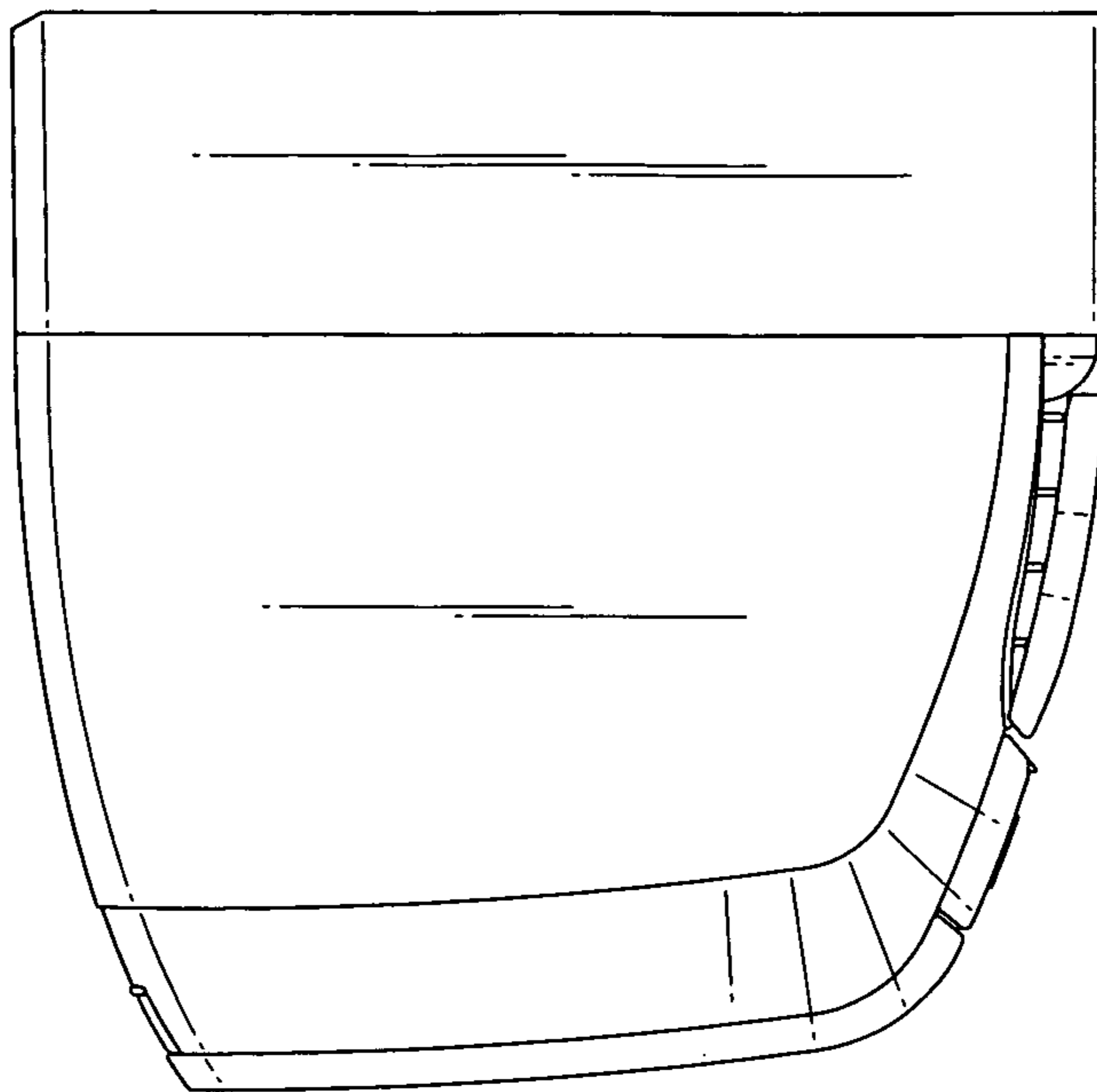

Fig. 7

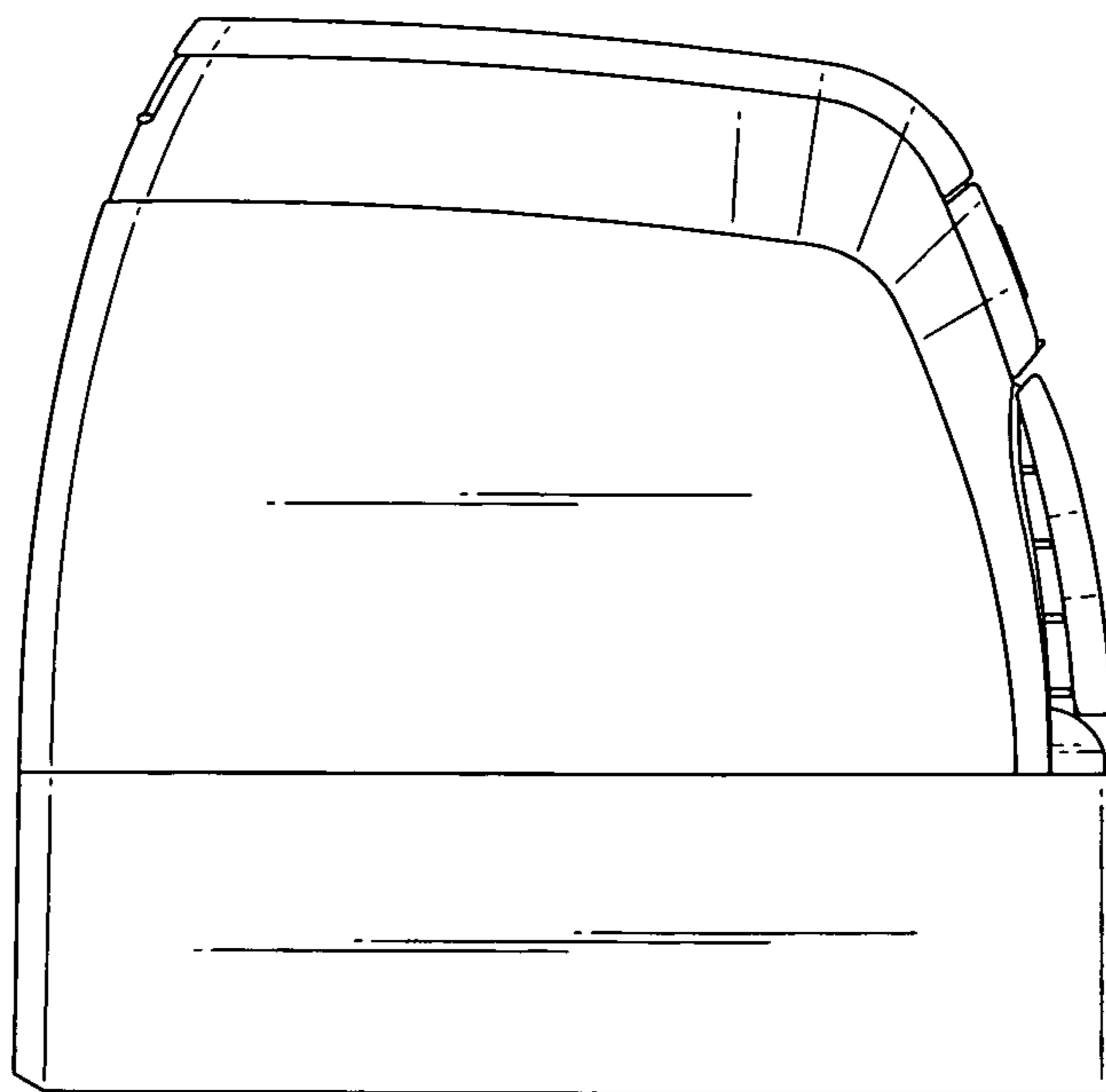



Fig. 9

