



US00D682812S

(12) **United States Design Patent**
Park

(10) **Patent No.:** **US D682,812 S**

(45) **Date of Patent:** **** May 21, 2013**

(54) **MICROPHONE**

(75) Inventor: **Sung Min Park**, Seoul (KR)

(73) Assignee: **Enter Tech Co., Ltd.**, Bucheon (KR)

(**) Term: **14 Years**

(21) Appl. No.: **29/400,504**

(22) Filed: **Aug. 29, 2011**

(30) **Foreign Application Priority Data**

Jun. 23, 2011 (KR) 30-2011-0025854

(51) **LOC (9) Cl.** **14-01**

(52) **U.S. Cl.**
USPC **D14/225**

(58) **Field of Classification Search** D14/138,
D14/205, 206, 218, 225-229, 496, 497; D17/10,
D17/20, 99; 379/430, 431; 381/111, 157,
381/158, 181, 355, 359, 361, 369; D13/168,
D13/177; D21/483; 455/95; 273/148 B;
466/416; 181/158, 242

See application file for complete search history.

(56) **References Cited**

U.S. PATENT DOCUMENTS

D495,319 S * 8/2004 Lee D14/497
D500,031 S * 12/2004 Hong D14/228
D519,499 S * 4/2006 Lee D14/497
D538,272 S * 3/2007 Lee D14/228

D557,690 S * 12/2007 Lee D14/228
D589,032 S * 3/2009 Lee D14/228
D612,367 S * 3/2010 Lee D14/228
D619,619 S * 7/2010 Lee D14/497
D620,954 S * 8/2010 Lee D14/497
D655,696 S * 3/2012 Lee D14/228

OTHER PUBLICATIONS

ET-19K Entertech Karaoke Wireless Microphone. [online]. Techno Avenue, © 2004-2012. [retrieved on Jul. 24, 2012]. Retrieved from internet <URL: <http://www.technoavenue.com/products/et19k-english-karaoke-microphone.html> >.*

* cited by examiner

Primary Examiner — Cathron Brooks

Assistant Examiner — Katie Mroczka

(57) **CLAIM**

The ornamental design for a microphone, as shown and described.

DESCRIPTION

FIG. 1 is a perspective view of a microphone showing my new design;

FIG. 2 is a front view thereof;

FIG. 3 is a rear view thereof;

FIG. 4 is a left-side view thereof;

FIG. 5 is a right-side view thereof;

FIG. 6 is a top plan view thereof; and,

FIG. 7 is a bottom plan view thereof.

Broken lines shown in the drawings illustrate portions of the microphone, and form no part of the claimed design.

1 Claim, 6 Drawing Sheets

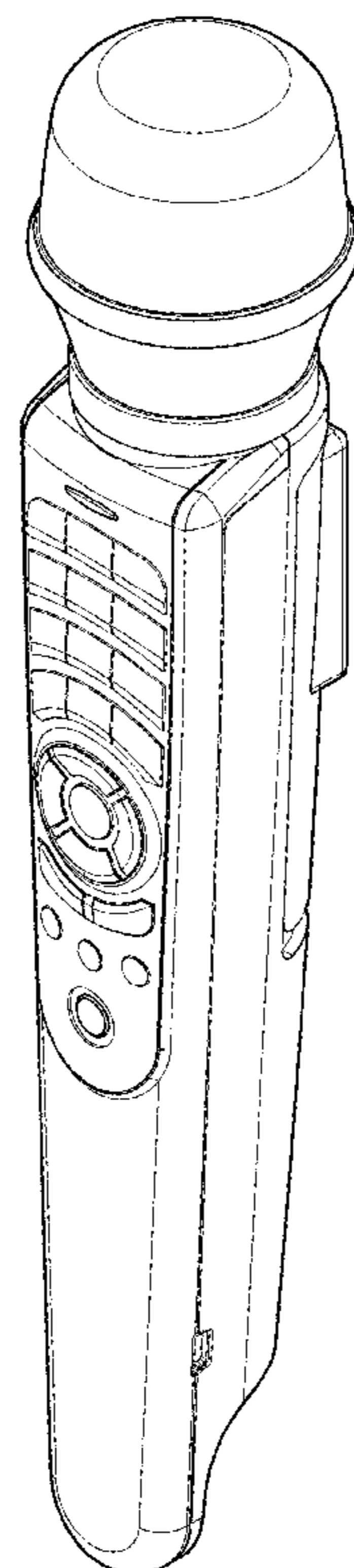

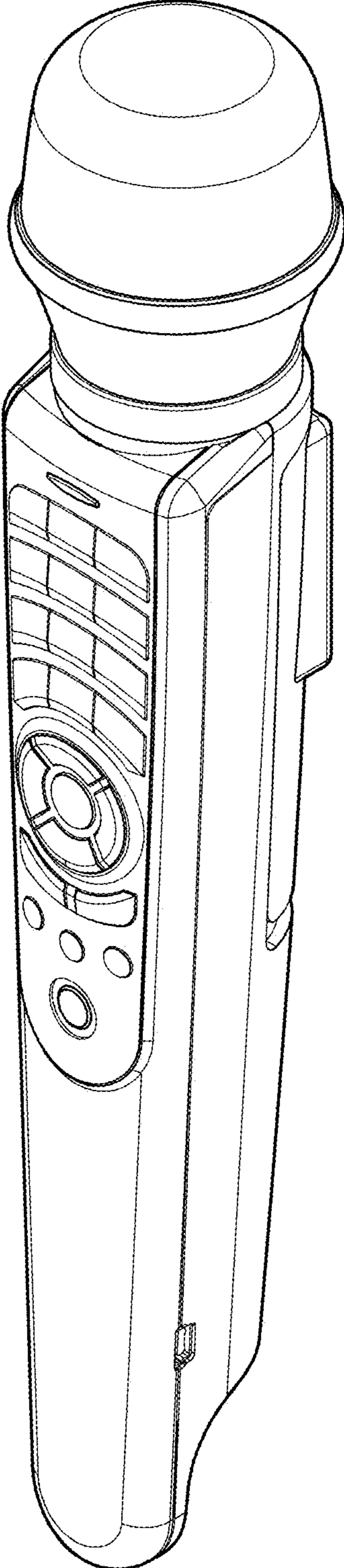

FIG. 1

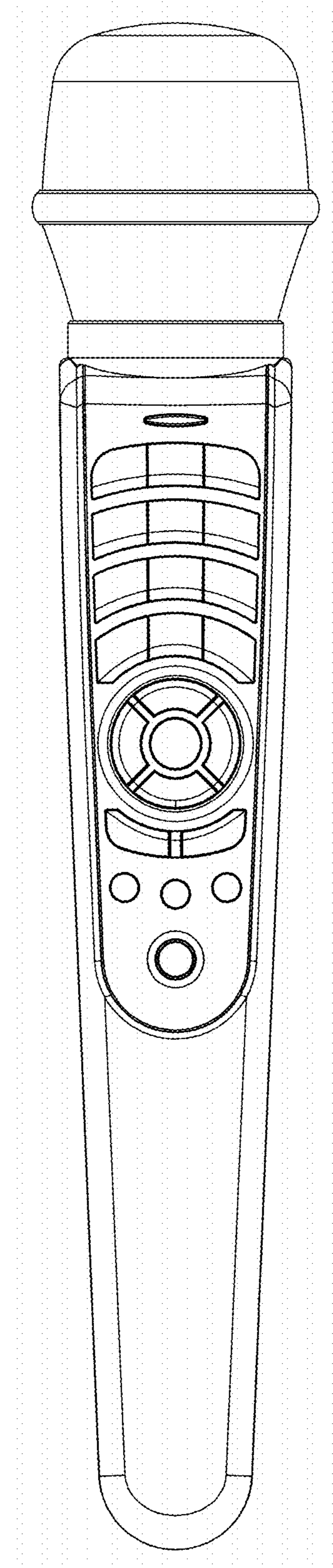
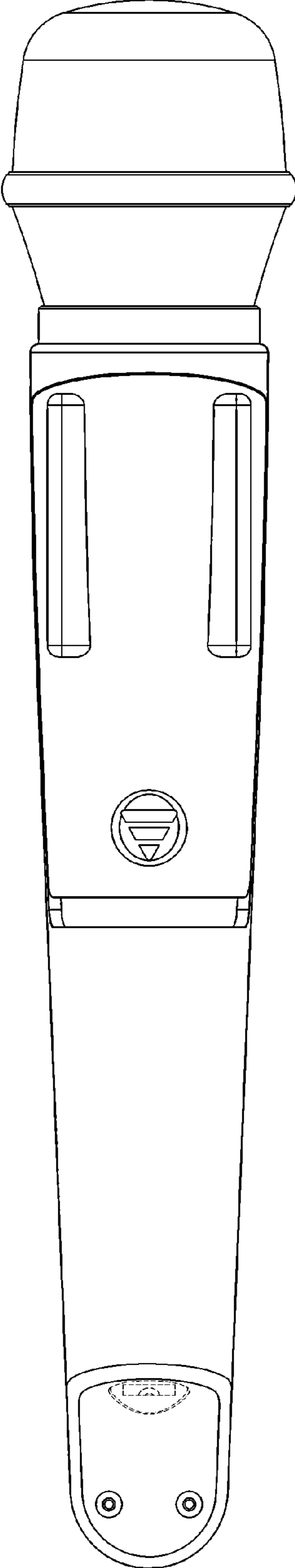

FIG. 2

FIG. 3



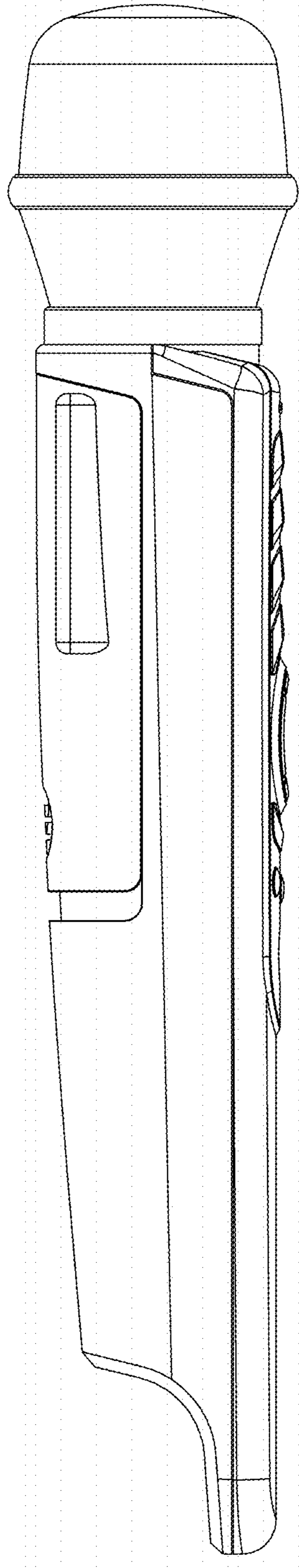

FIG. 4

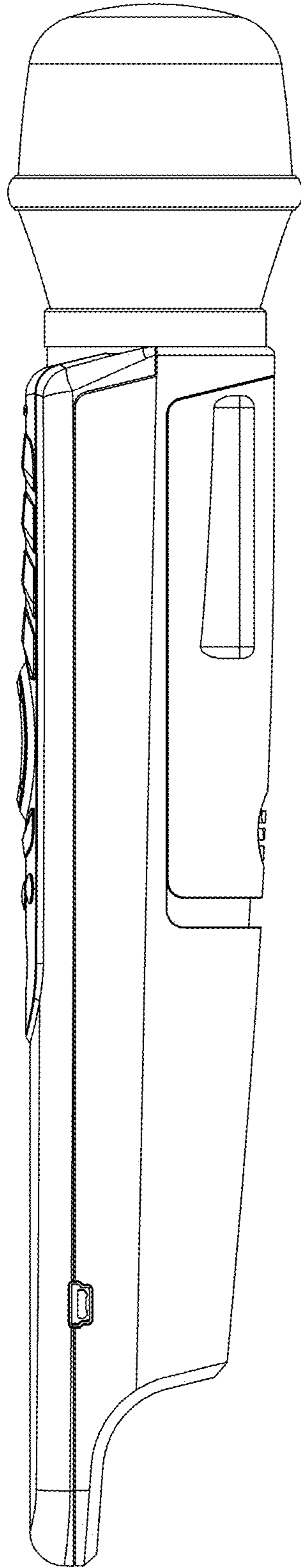

FIG. 5

FIG. 6

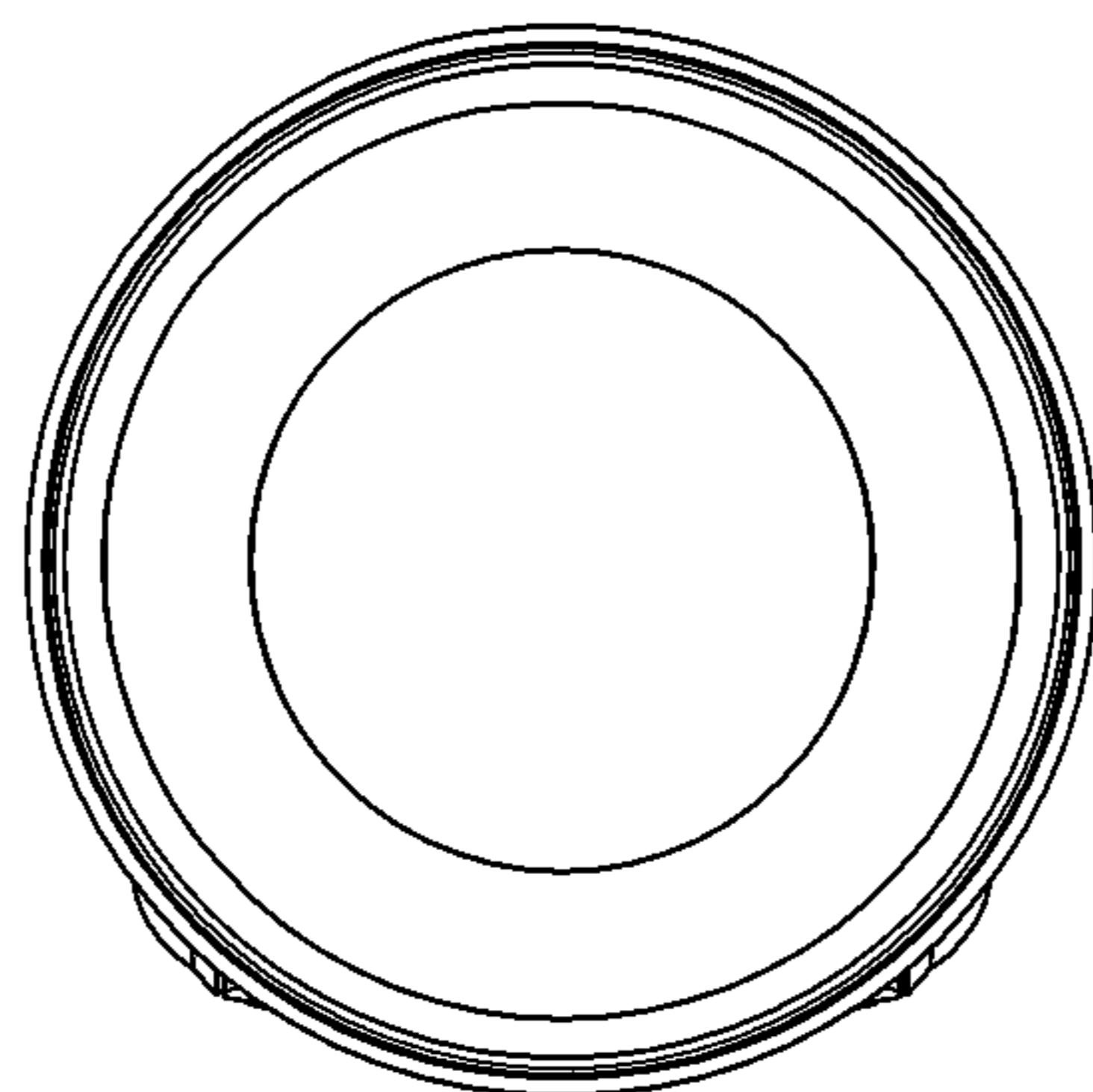

FIG. 7

