



US00D682588S

(12) **United States Design Patent**
Yang

(10) **Patent No.:** **US D682,588 S**

(45) **Date of Patent:** **** May 21, 2013**

(54) **BAG DISPENSER**

(75) Inventor: **Jun Yang**, Shanghai (CN)

(73) Assignee: **CeDo Folien und Haushaltsprodukte GmbH** (DE)

(**) Term: **14 Years**

(21) Appl. No.: **29/407,335**

(22) Filed: **Nov. 28, 2011**

(30) **Foreign Application Priority Data**

May 31, 2011 (EM) 001280978-0001

(51) **LOC (9) Cl.** **06-04**

(52) **U.S. Cl.**
USPC **D6/518**

(58) **Field of Classification Search** D6/542-545,
D6/553, 567, 574, 515-525, 549; 206/77.1;
211/13.1, 86.01, 87.01; 221/14, 92, 649,
221/146.1, 146.2, 105; 222/281-282; D11/51,
D11/82, 134; D8/349, 354, 363, 373, 394,
D8/402; D24/155; D7/631; D21/385, 386,
D21/576, 611

See application file for complete search history.

(56) **References Cited**

U.S. PATENT DOCUMENTS

| | | | | |
|--------------|---------|----------------|-------|--------|
| D75,824 S * | 7/1928 | Blewett | | D11/82 |
| D93,971 S * | 12/1934 | Clark | | D8/402 |
| D480,243 S * | 10/2003 | Edwards et al. | | D6/515 |
| D498,955 S * | 11/2004 | Edwards | | D6/515 |
| D502,622 S * | 3/2005 | Berger | | D6/515 |
| D543,743 S * | 6/2007 | Edwards | | D6/515 |
| D568,653 S * | 5/2008 | Edwards | | D6/515 |
| D642,842 S * | 8/2011 | Stoekler | | D6/572 |

* cited by examiner

Primary Examiner — Brian N Vinson

(74) *Attorney, Agent, or Firm* — Fox Rothschild LLP

(57) **CLAIM**

The ornamental design for a bag dispenser, as shown and described.

DESCRIPTION

FIG. 1 is a left side view of a first embodiment of bag dispenser showing my new design;

FIG. 2 is a right side view of the bag dispenser shown in FIG. 1;

FIG. 3 is a top view of the bag dispenser shown in FIG. 1;

FIG. 4 is a bottom view of the bag dispenser shown in FIG. 1;

FIG. 5 is a front view of the bag dispenser shown in FIG. 1;

FIG. 6 is a rear view of the bag dispenser shown in FIG. 1;

FIG. 7 is a left side view of a second embodiment of bag dispenser showing my new design;

FIG. 8 is a right side view of the bag dispenser shown in FIG. 7;

FIG. 9 is a top view of the bag dispenser shown in FIG. 7;

FIG. 10 is a bottom view of the bag dispenser shown in FIG. 7;

FIG. 11 is a front view of the bag dispenser shown in FIG. 7; and,

FIG. 12 is a rear view of the bag dispenser shown in FIG. 7.

The features shown in dotted lines in the drawings depict environmental subject matter only and form no part of the claimed design. The vertical dotted lines in FIGS. 1, 2, 3, 4, 7, 8, 9 and 10 represent a joint along which two halves of the article can be separated, the joint forming no part of the claimed design. The dotted lines within the two legs shown in FIGS. 4 and 10 represent a wall thickness of the legs, and form no part of the claimed design. The dotted lines forming the ellipses in FIG. 4 between the two legs, seen from the side in FIGS. 1 and 2, represent a shoulder surrounding an opening in the bottom of the design, and form no part of the claimed design.

1 Claim, 2 Drawing Sheets

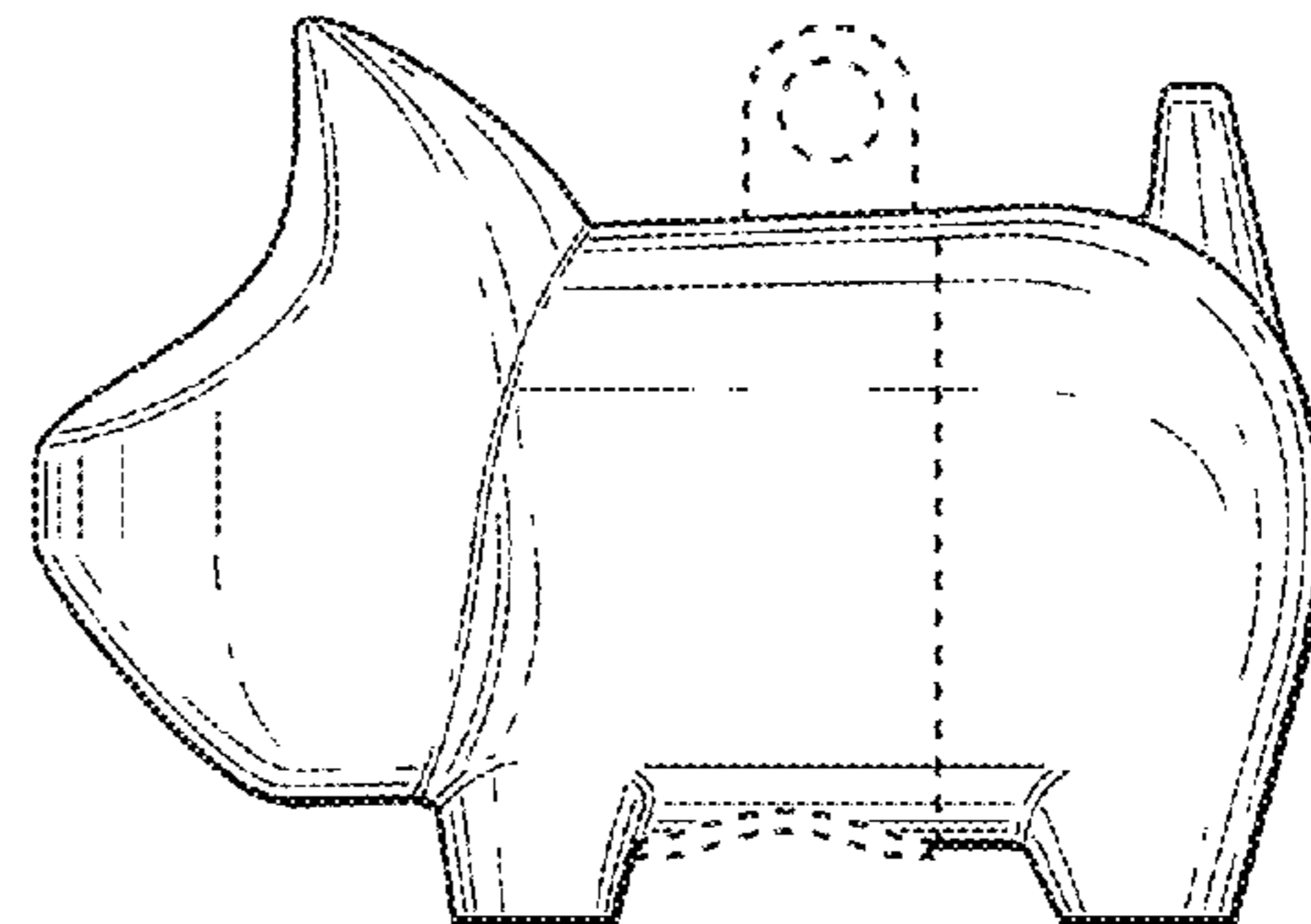
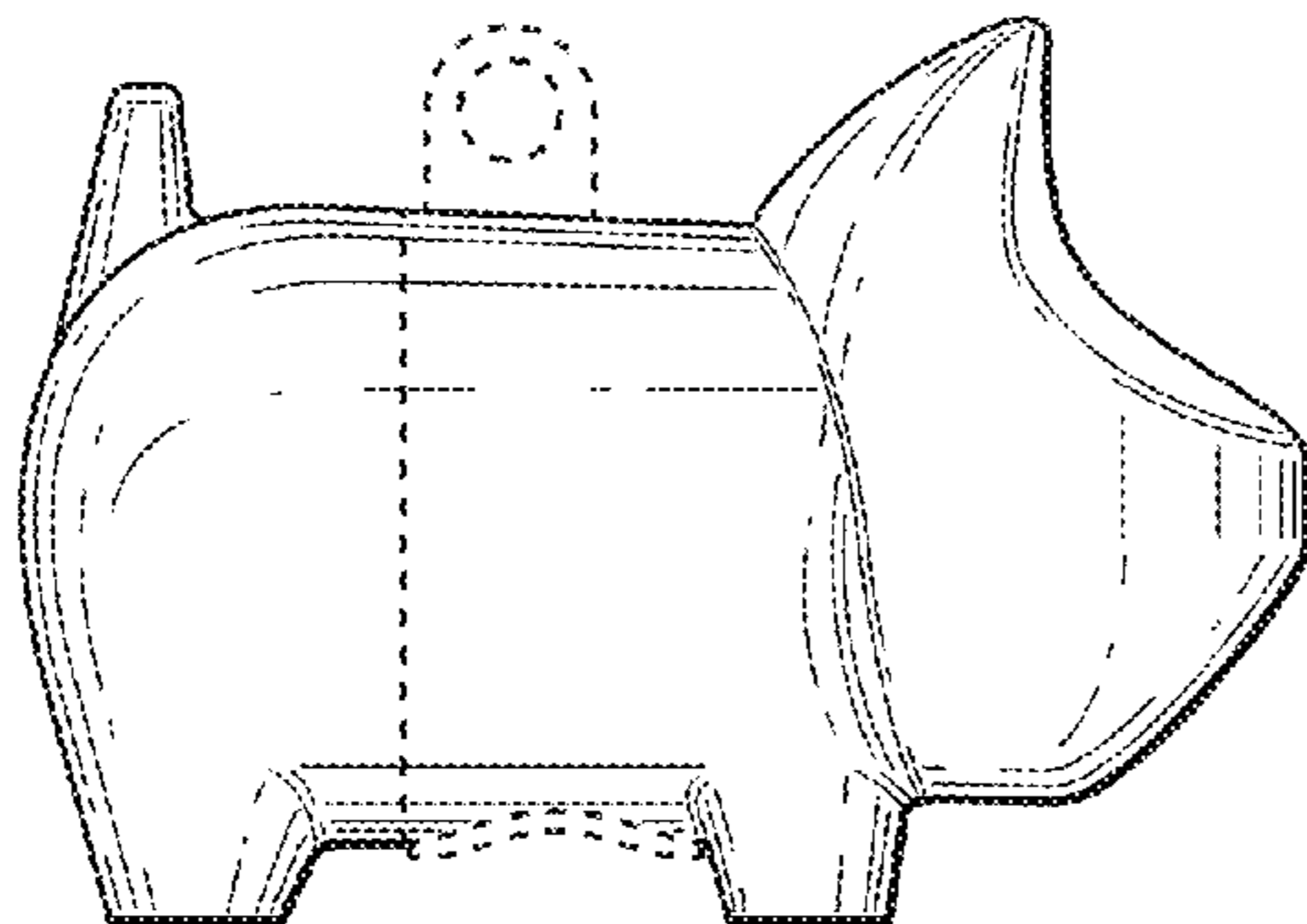

FIG.1

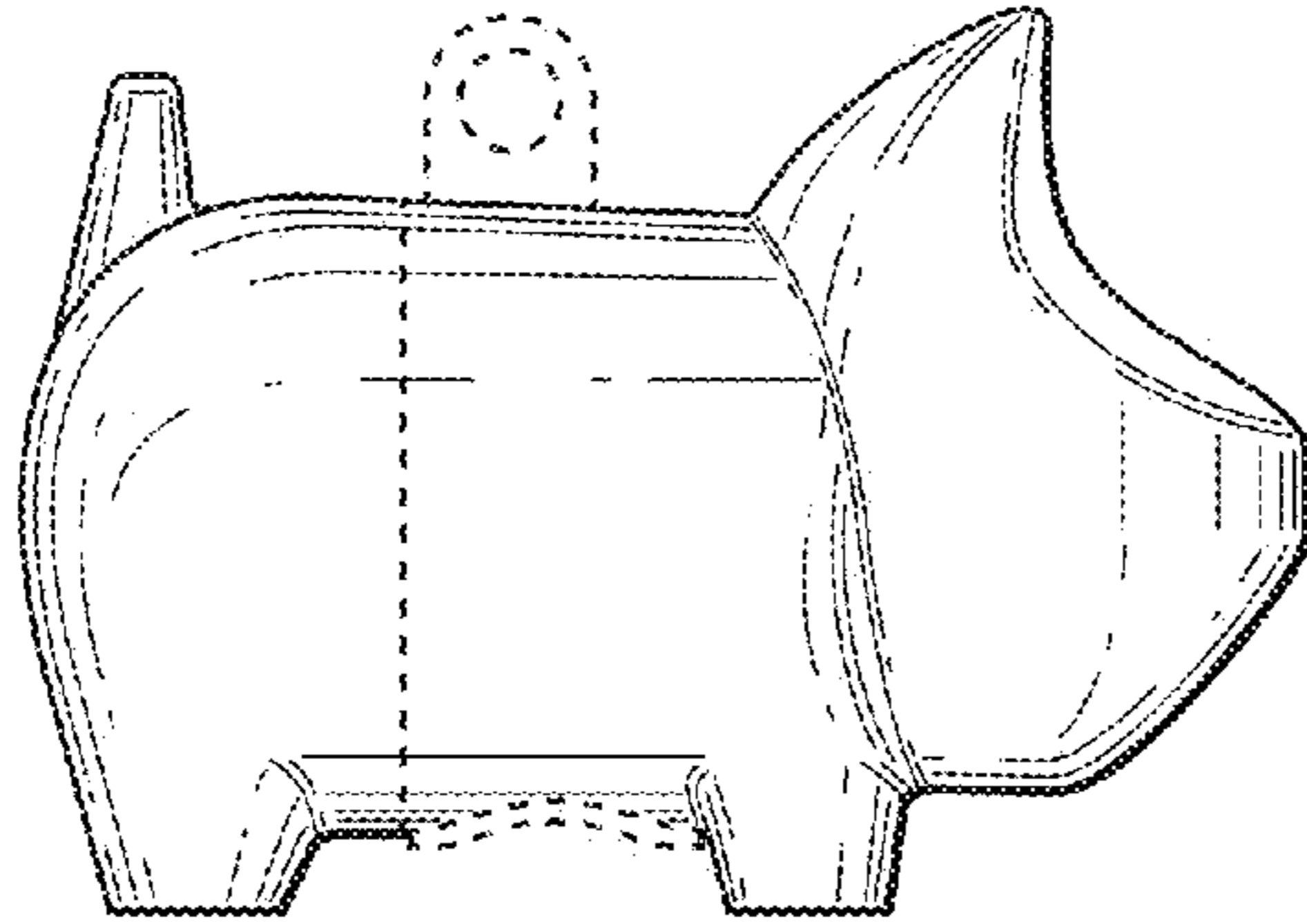

FIG.2

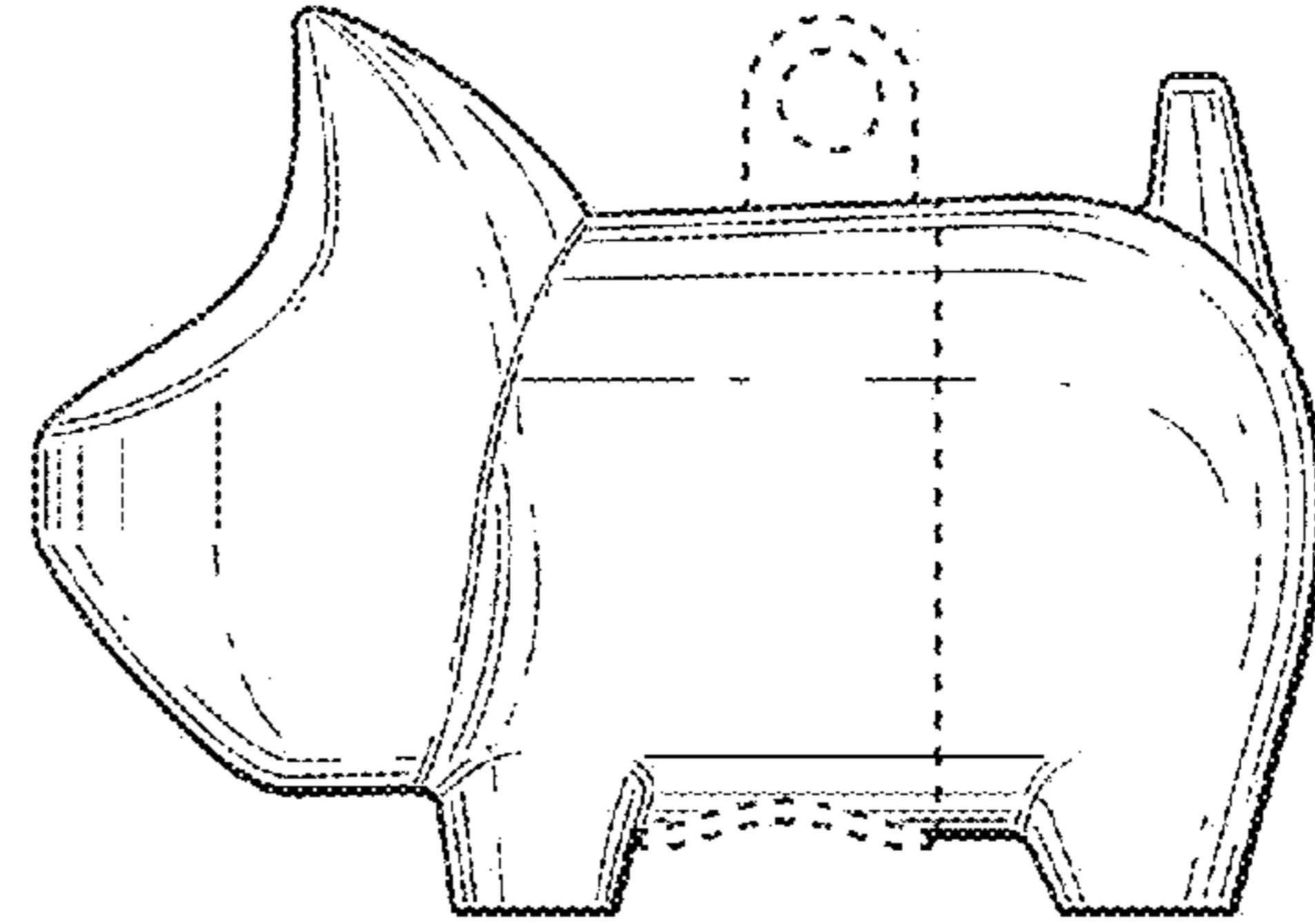

FIG.3

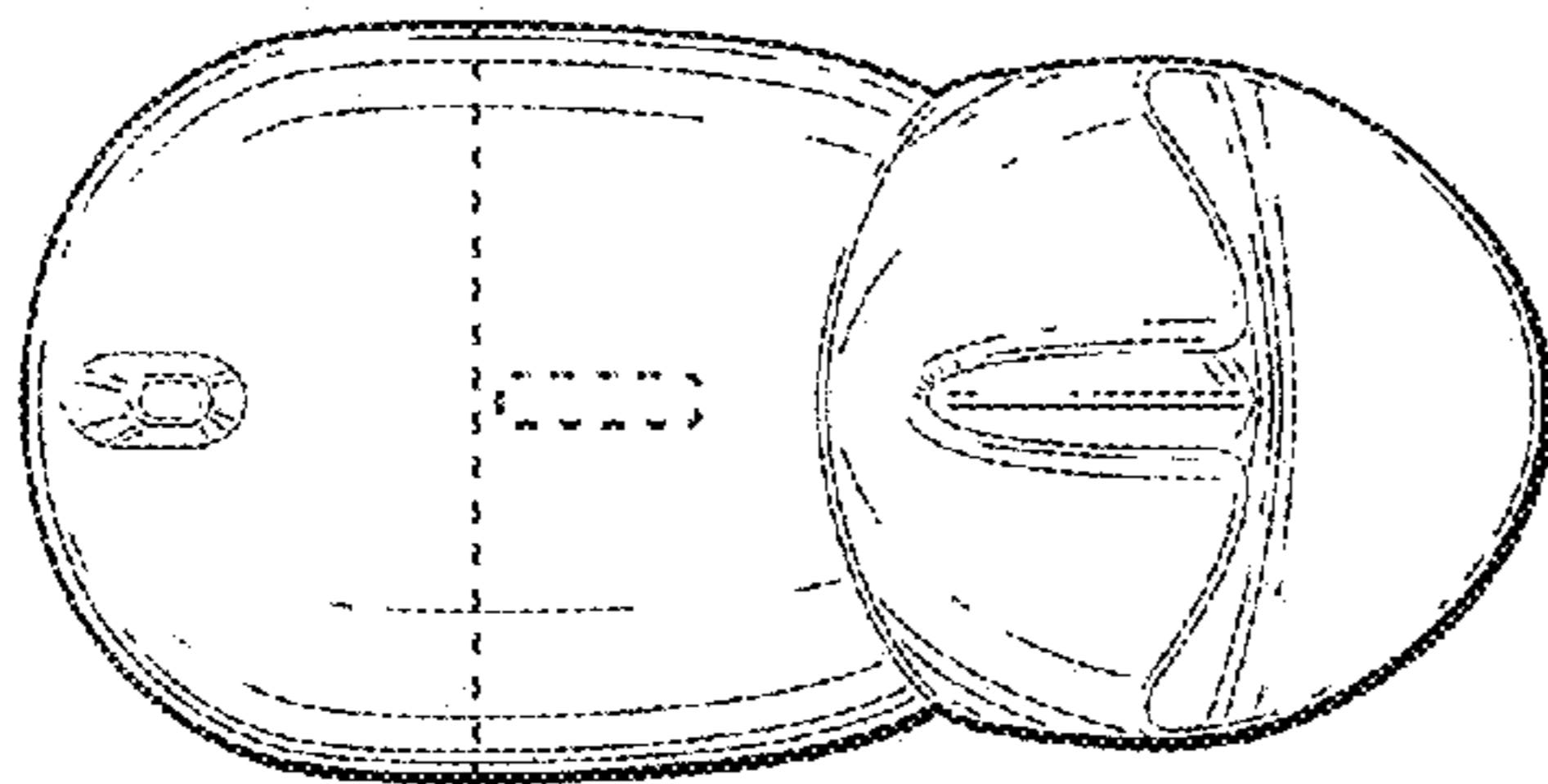

FIG.4

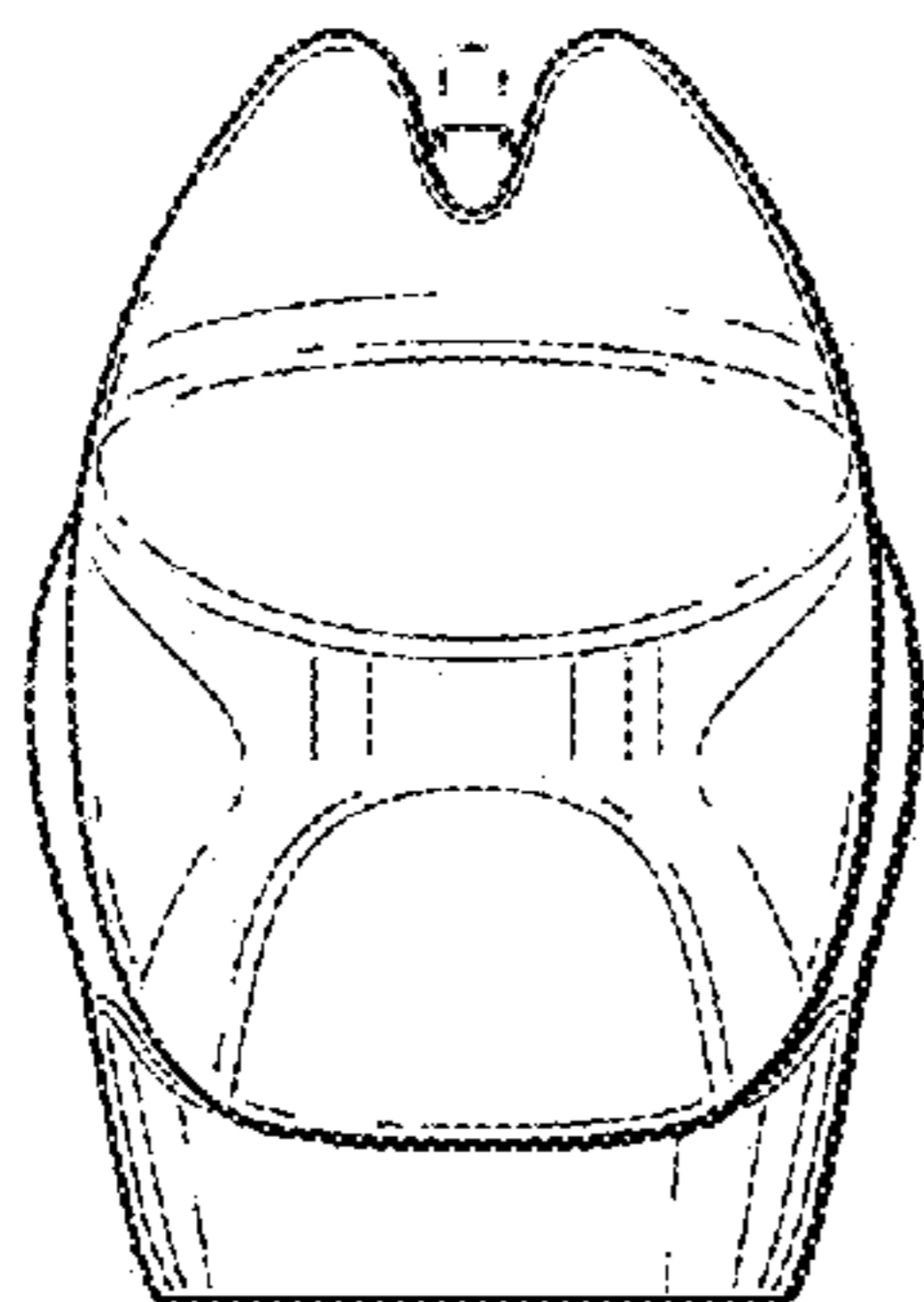
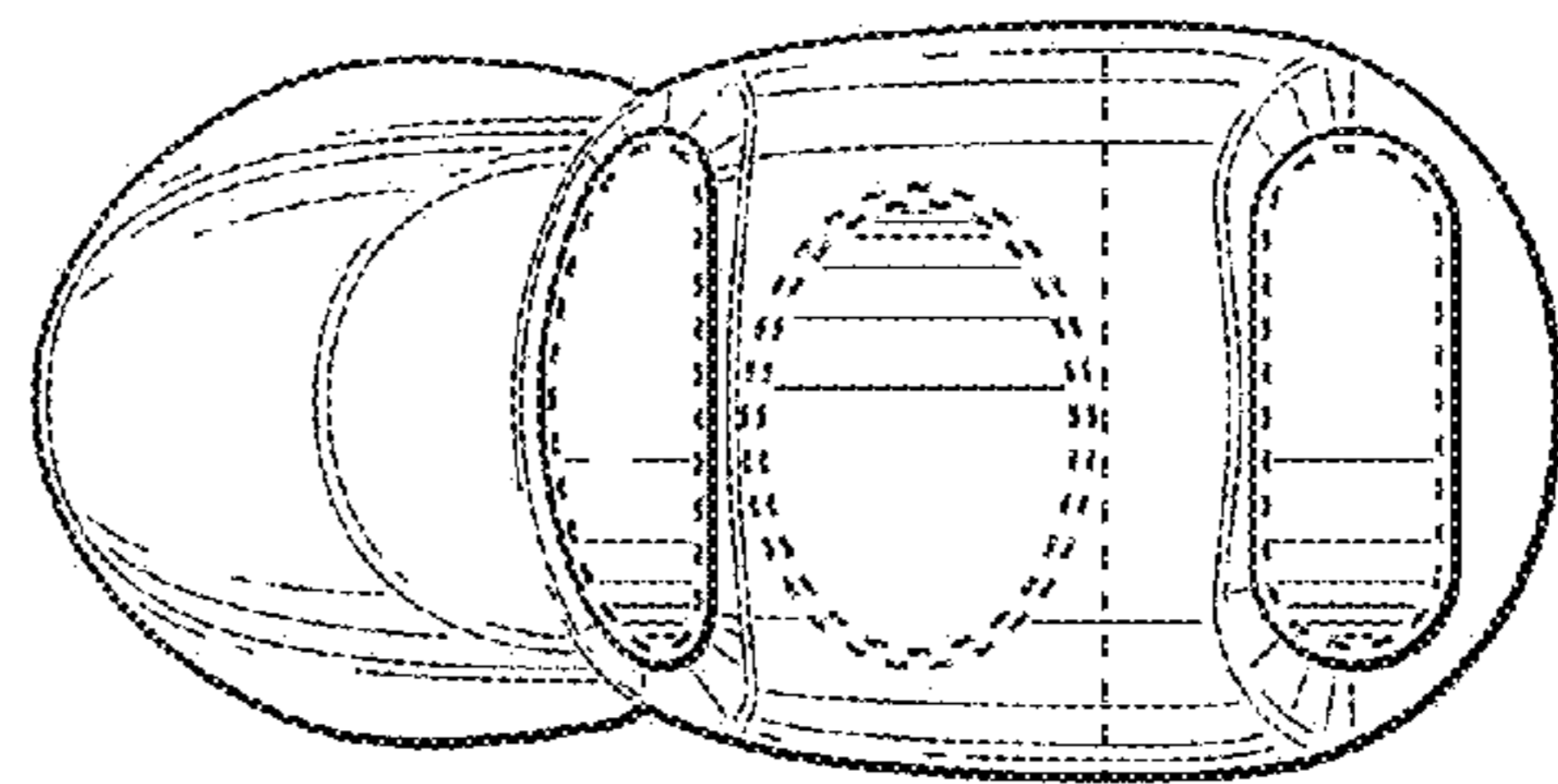

FIG.5

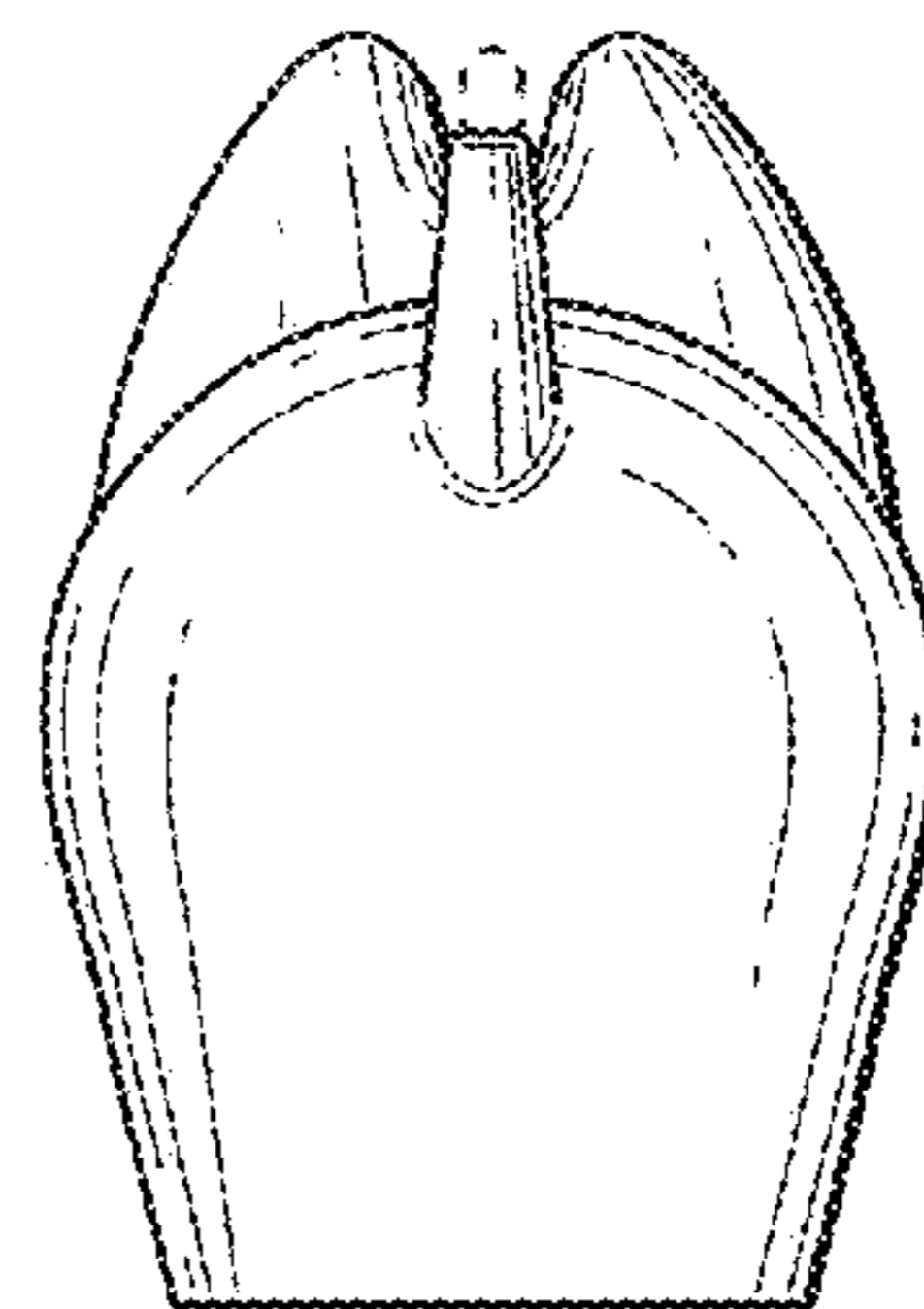

FIG.6

FIG. 7

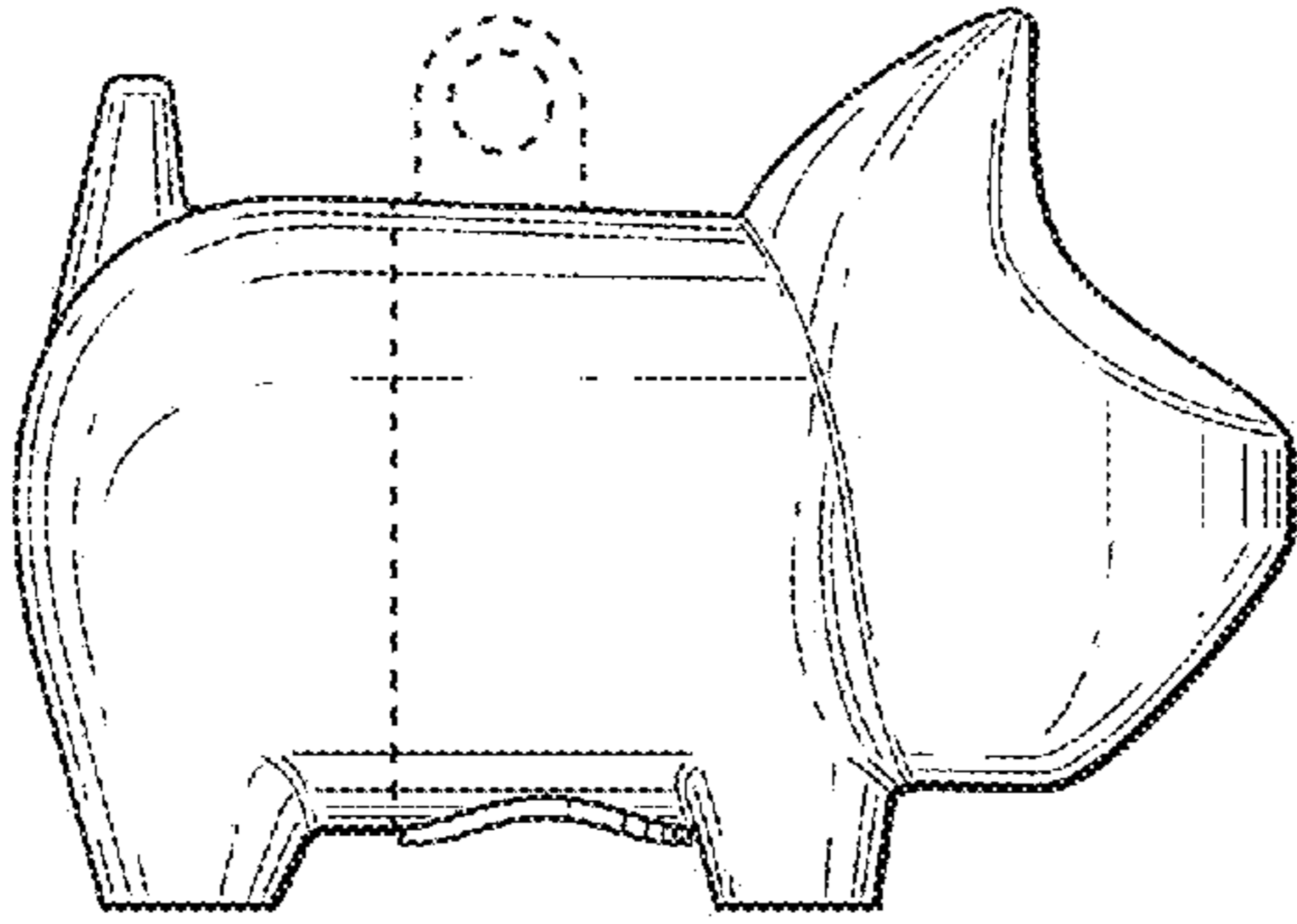

FIG. 8

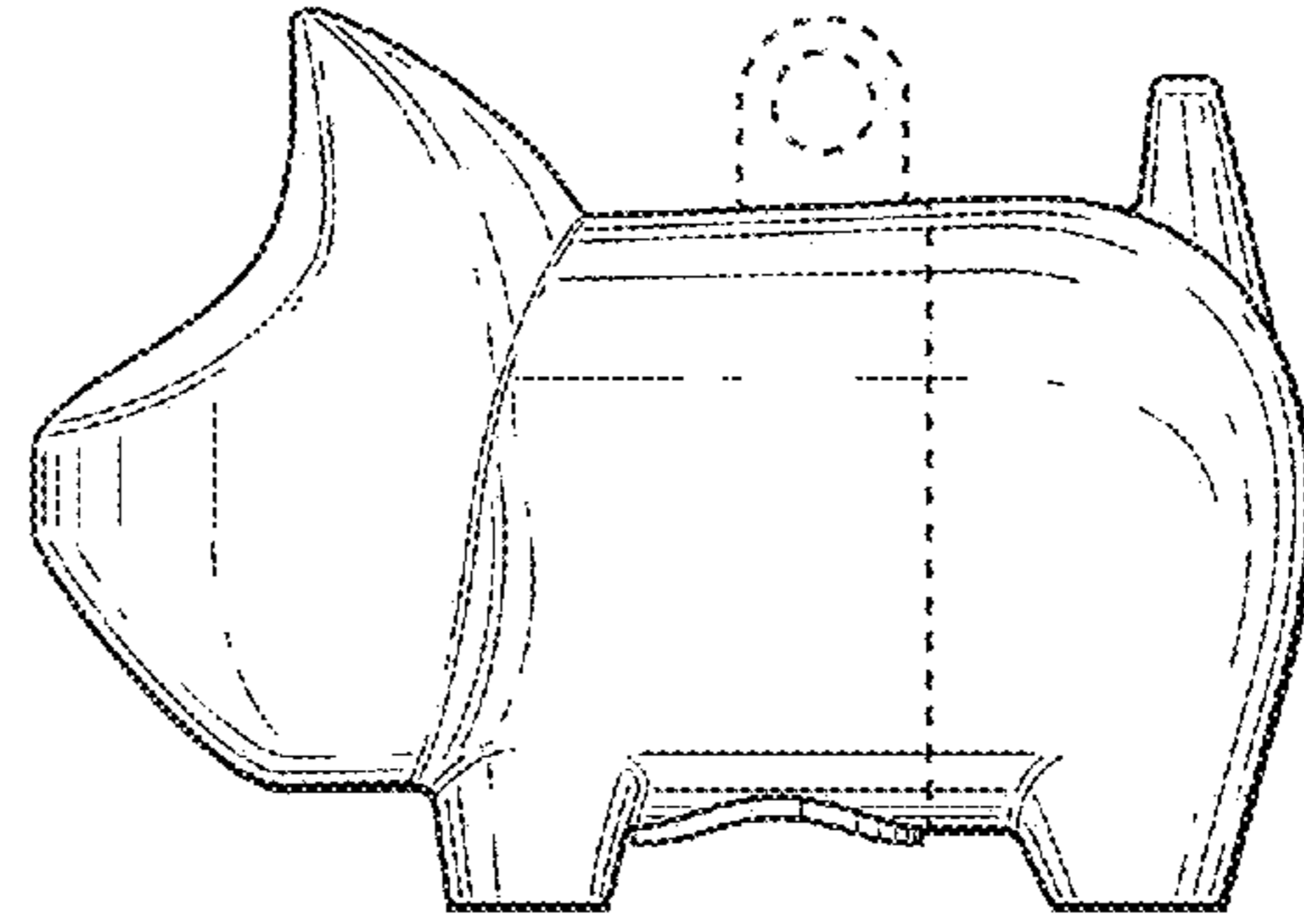

FIG. 9

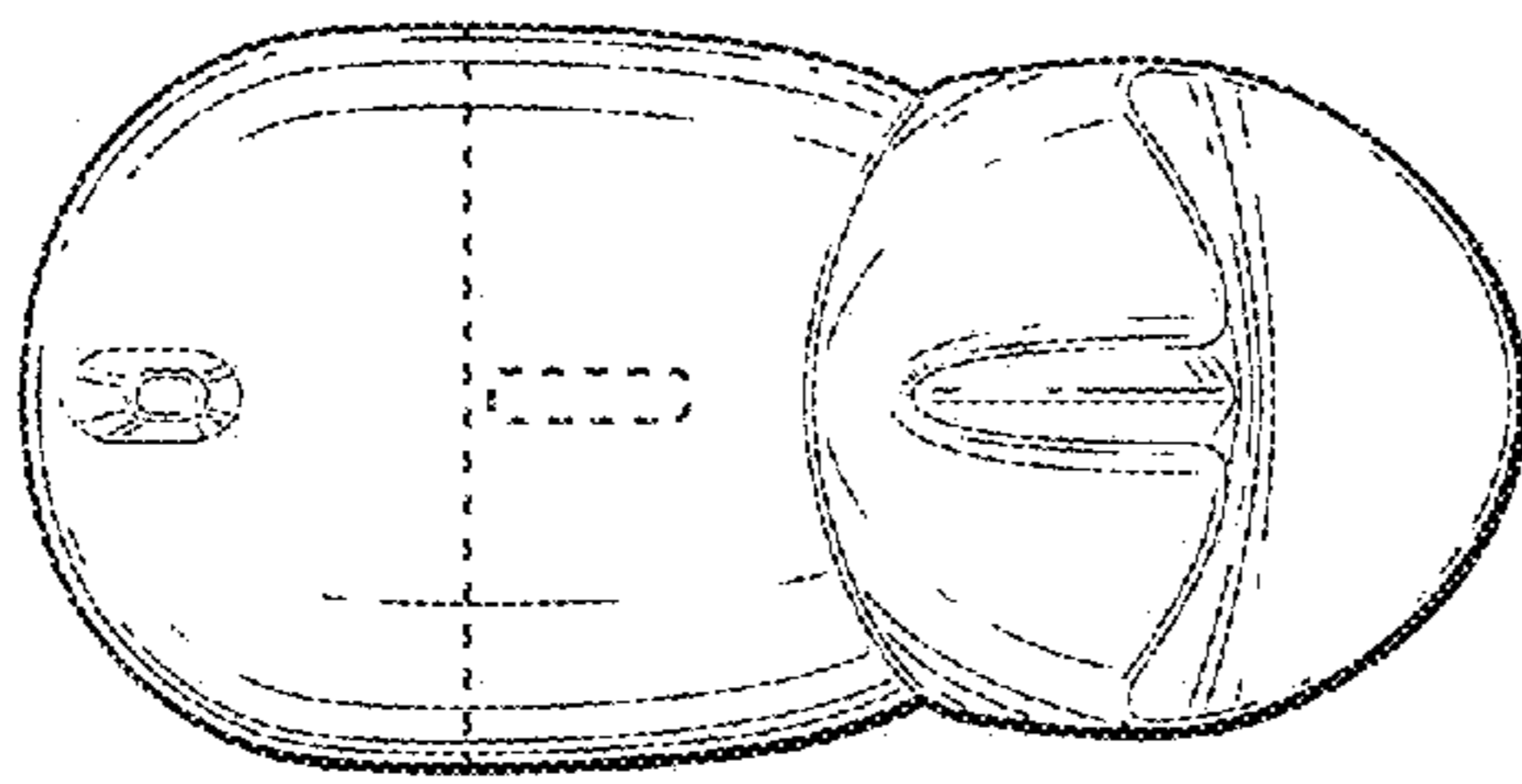

FIG. 10

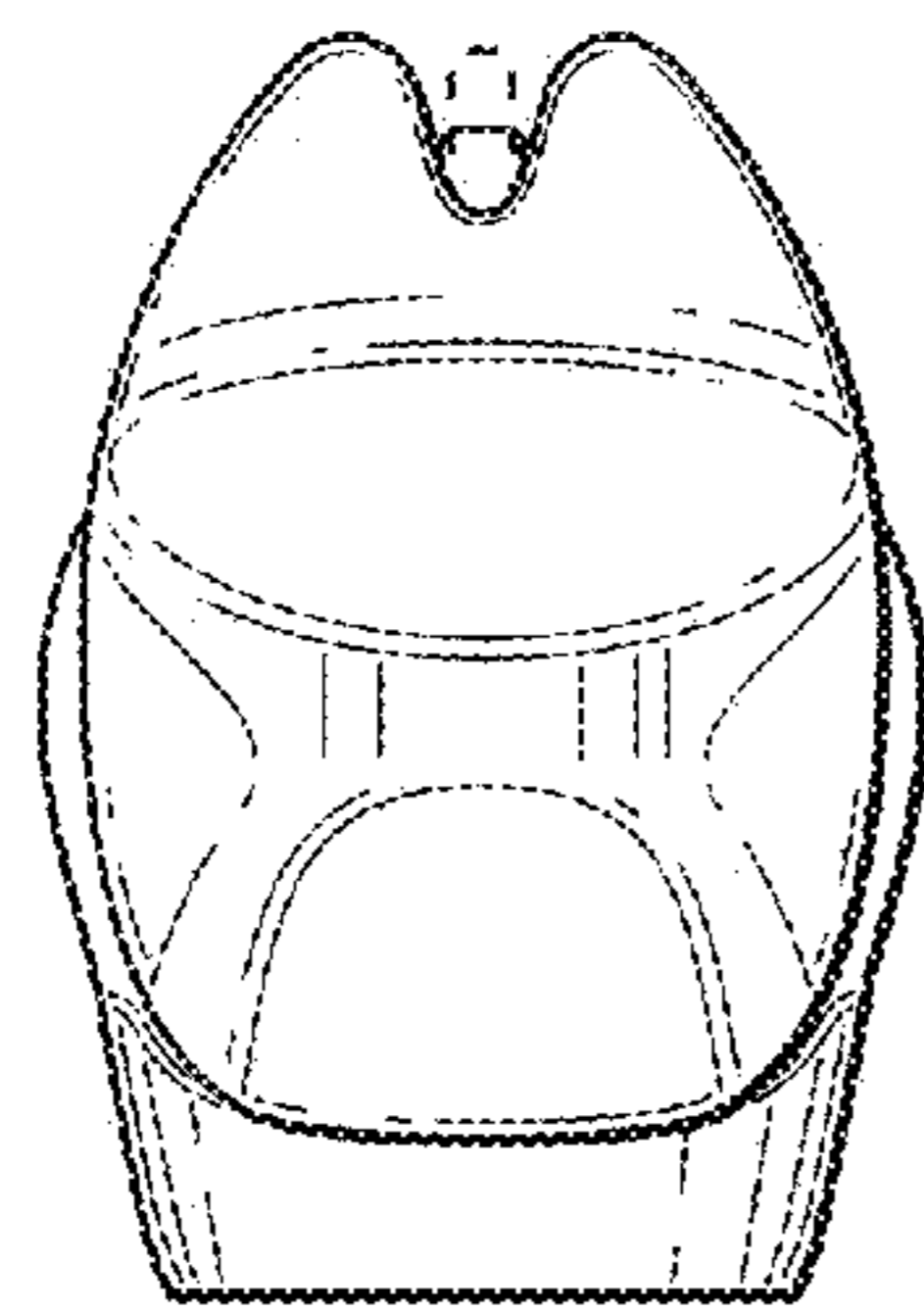
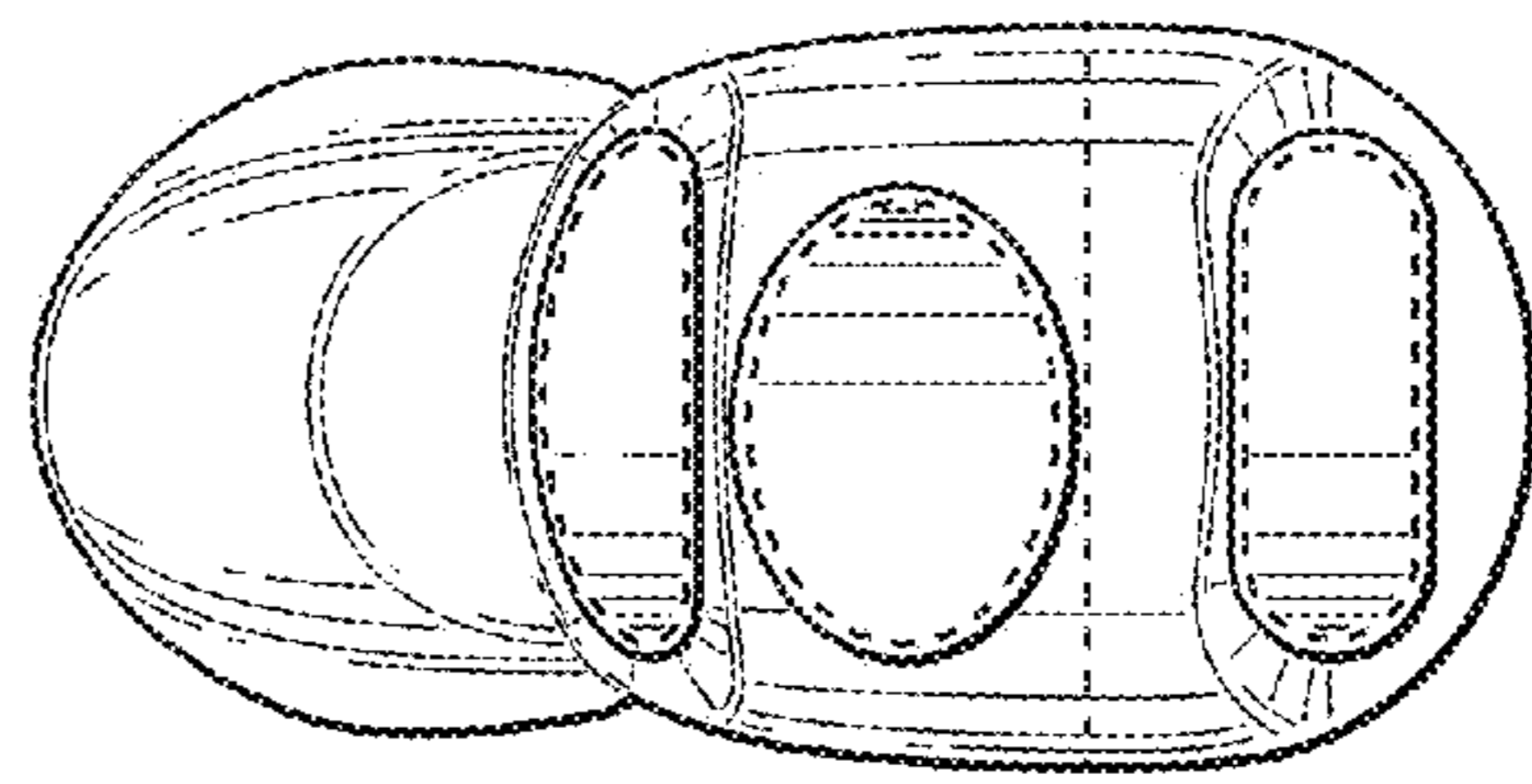

FIG. 11

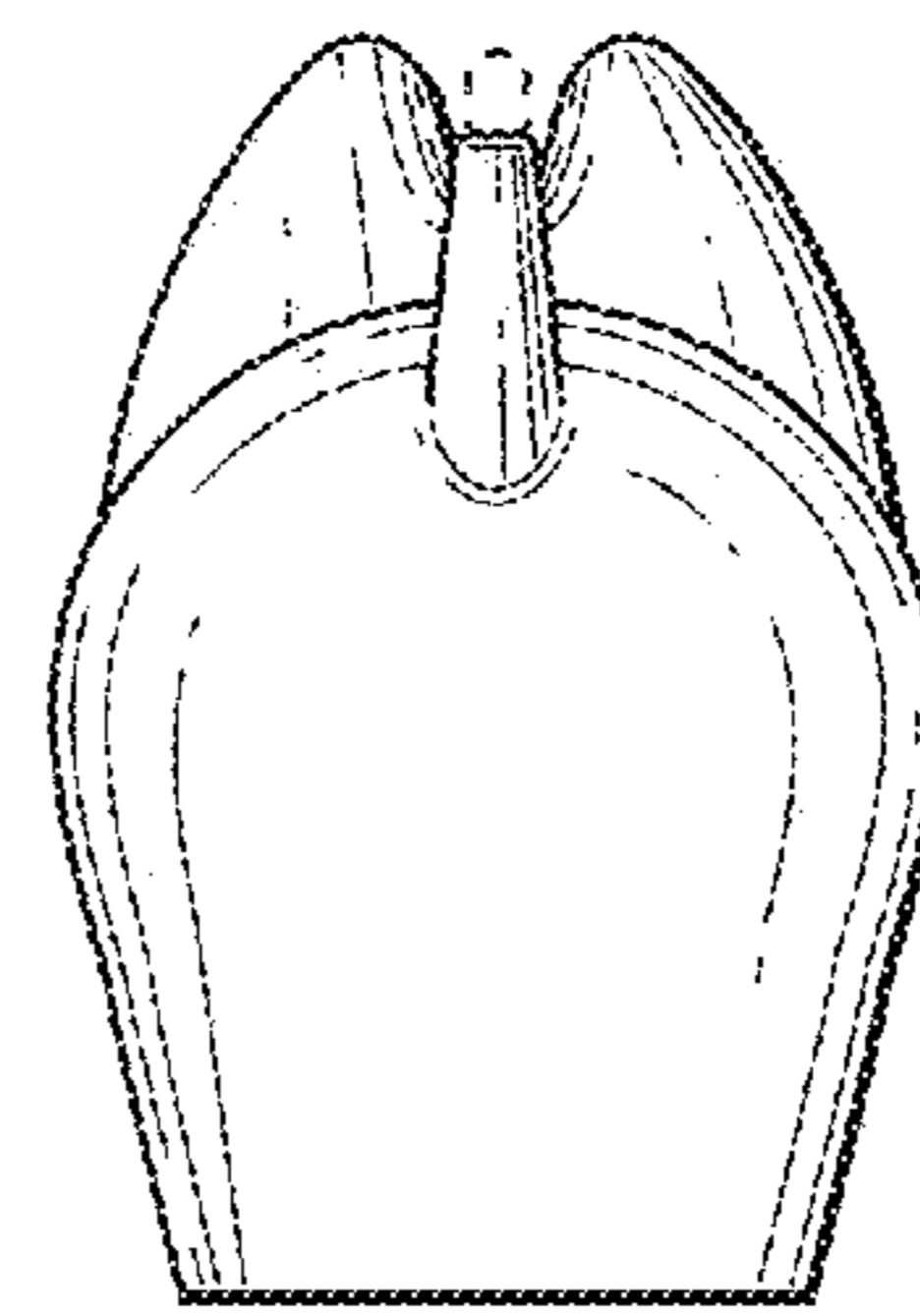

FIG. 12