



US00D682552S

(12) **United States Design Patent**
Ambrefe, Jr.

(10) **Patent No.:** **US D682,552 S**

(45) **Date of Patent:** **** May 21, 2013**

(54) **TRAY**

(75) **Inventor:** **Joseph T. Ambrefe, Jr.**, Indian Rocks Beach, FL (US)

(73) **Assignee:** **Securitypoint Holdings LLC**, Tampa, FL (US)

(**) **Term:** **14 Years**

(21) **Appl. No.:** **29/413,645**

(22) **Filed:** **Feb. 17, 2012**

(51) **LOC (9) Cl.** **03-01**

(52) **U.S. Cl.**
USPC **D3/304**

(58) **Field of Classification Search**
USPC D3/201, 205–206, 304, 307–308,
D3/315; D6/406.3, 449, 467, 475, 510;
D19/77–78, 86, 92; 206/203, 214–215;
229/406–407, 913

See application file for complete search history.

(56) **References Cited**

U.S. PATENT DOCUMENTS

D251,479 S * 4/1979 Cherry D3/314
D260,345 S * 8/1981 Goodrich D7/548
D515,315 S * 2/2006 Rader et al. D3/304

D596,902 S * 7/2009 Hrovat D7/550.1
D600,502 S * 9/2009 Paslawski D7/548
D612,153 S * 3/2010 Liao D3/304
D620,291 S * 7/2010 Smith et al. D6/525
D635,771 S * 4/2011 Man D3/304
D650,912 S * 12/2011 Tomes et al. D24/227

* cited by examiner

Primary Examiner — Kelley Donnelly

(74) *Attorney, Agent, or Firm* — Don J. Pelto, Esquire;
Sheppard, Mullin, Richter & Hampton LLP

(57) **CLAIM**

The ornamental design for a tray, as shown and described.

DESCRIPTION

FIG. 1 is a perspective view of a tray embodying the new design.

FIG. 2 is a left side view of the tray embodying the new design.

FIG. 3 is a right side view of the tray embodying the new design.

FIG. 4 is a front view of the tray embodying the new design.

FIG. 5 is a back view of the tray embodying the new design.

FIG. 6 is a top view of the tray embodying the new design; and,

FIG. 7 is a bottom view of the tray embodying the new design.

The portions of the tray shown in broken lines form no part of the claimed invention.

1 Claim, 5 Drawing Sheets

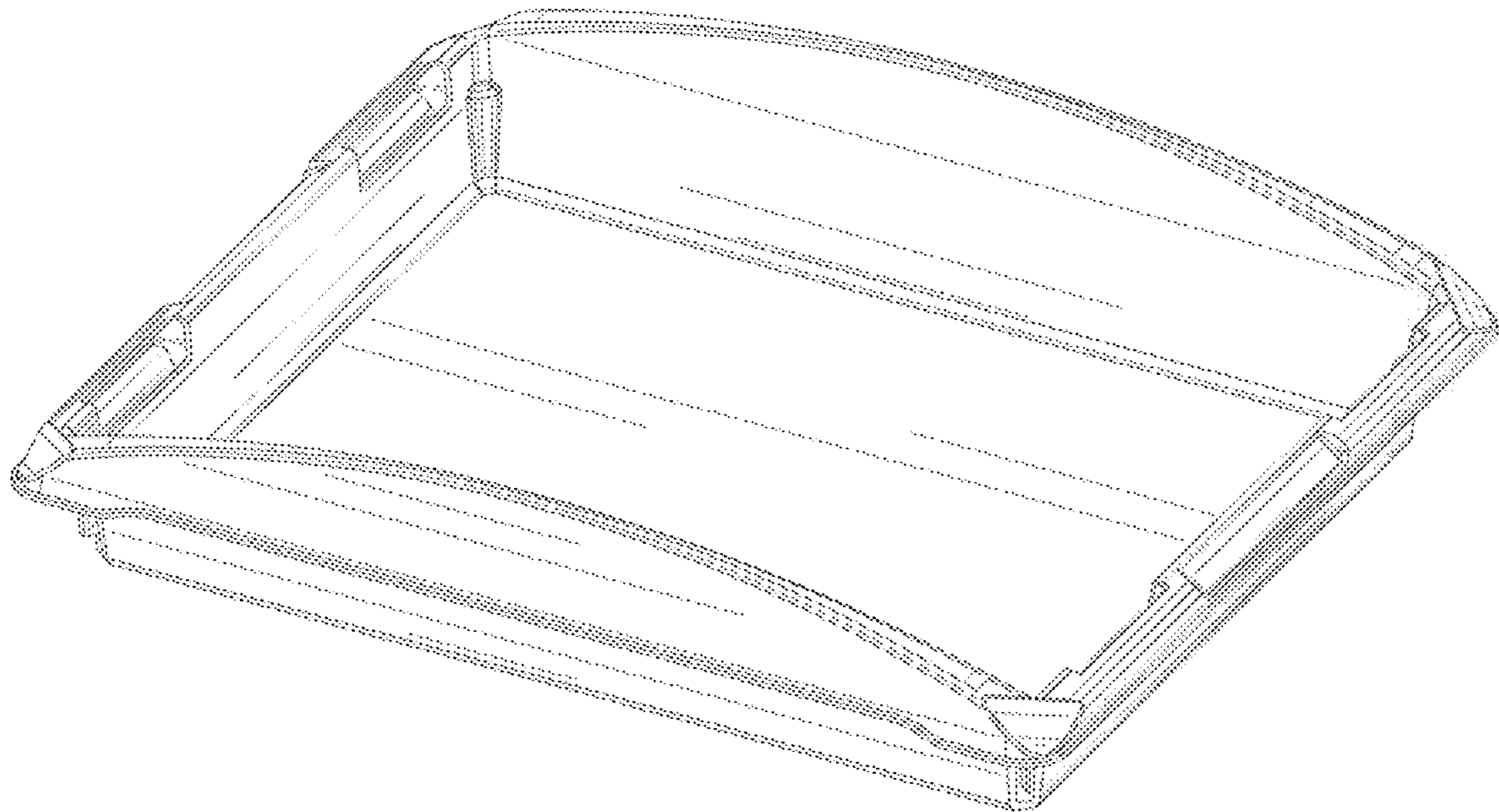

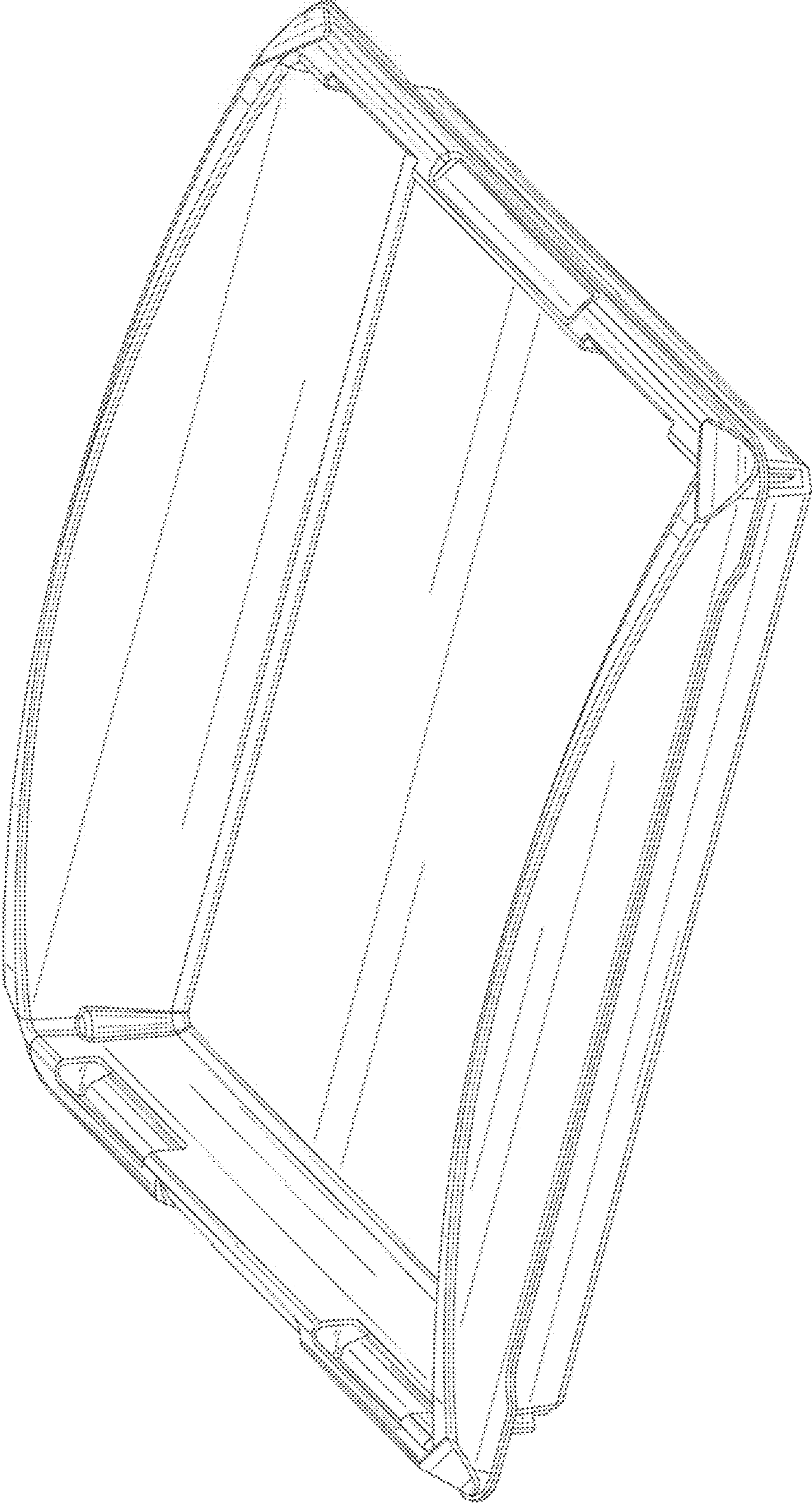

FIG. 1

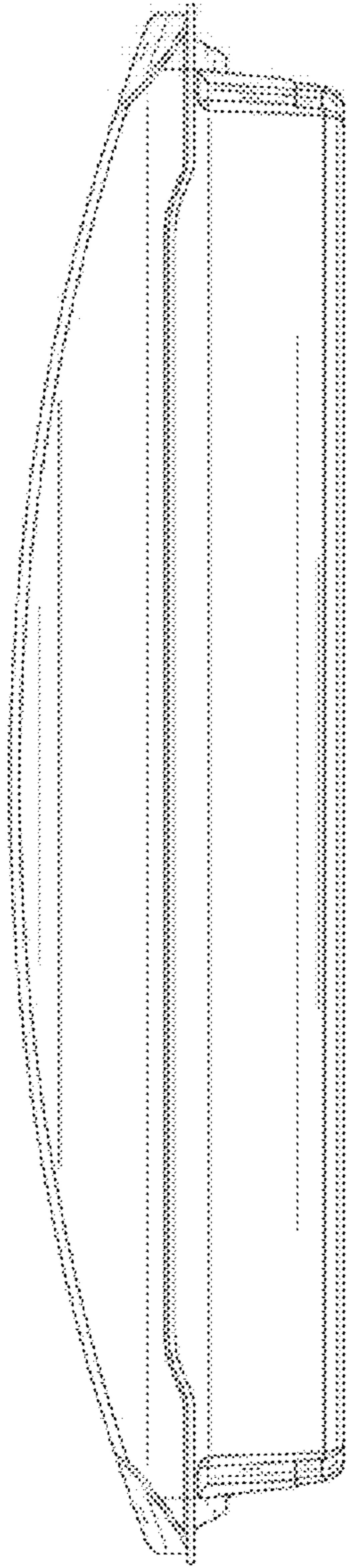

FIG. 2

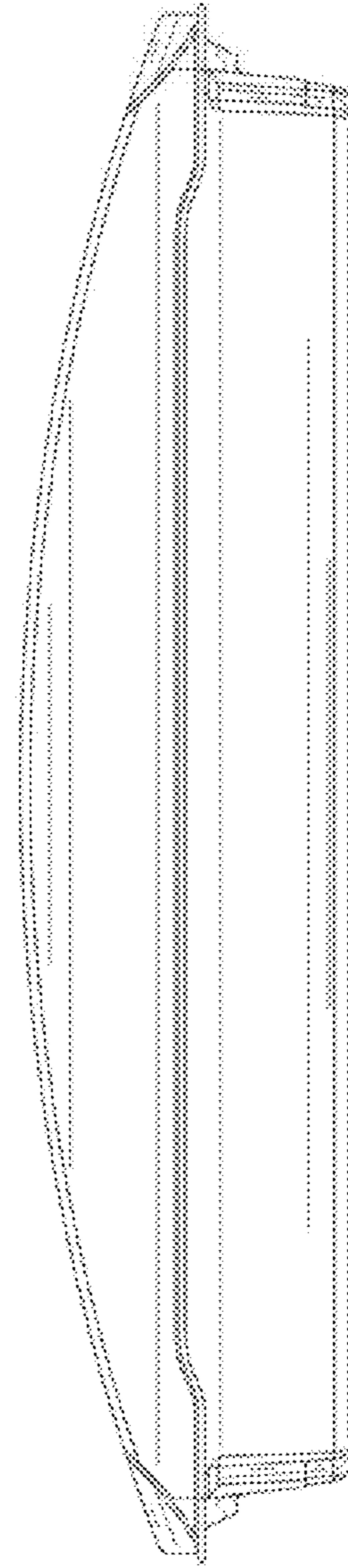

FIG. 3

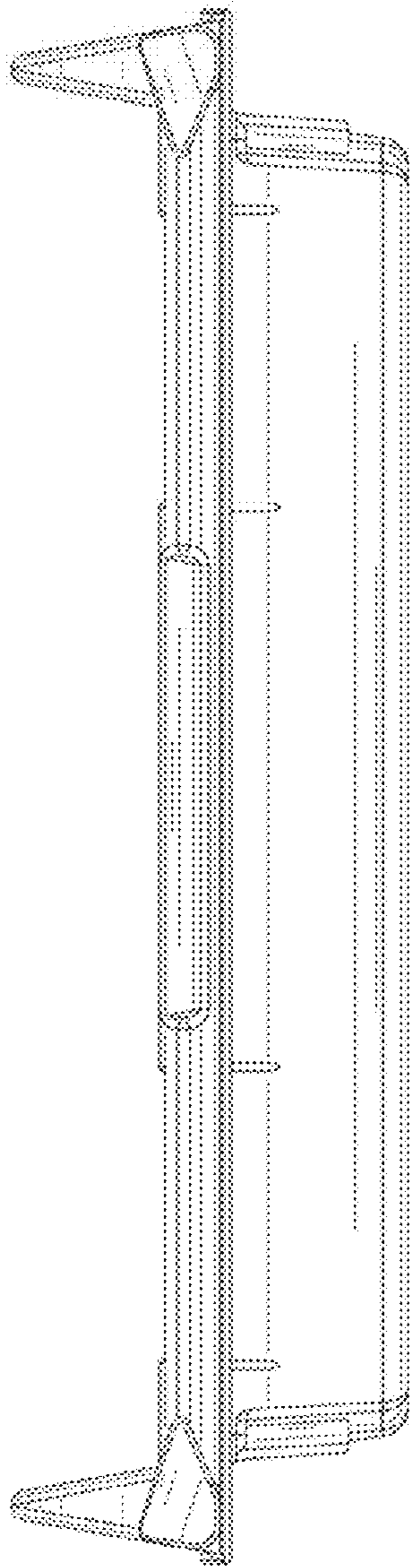

FIG. 4

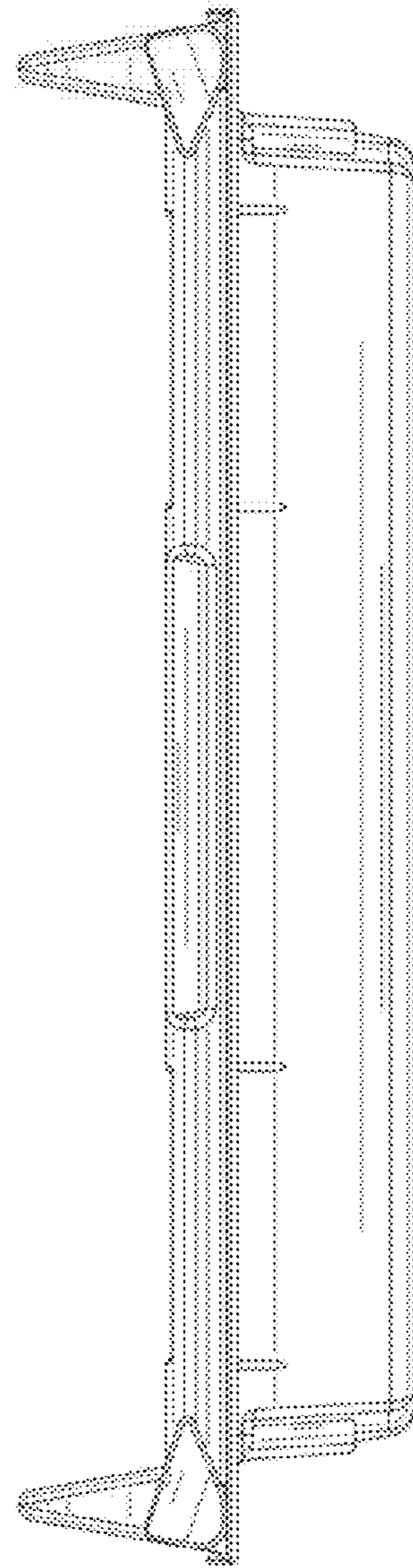

FIG. 5

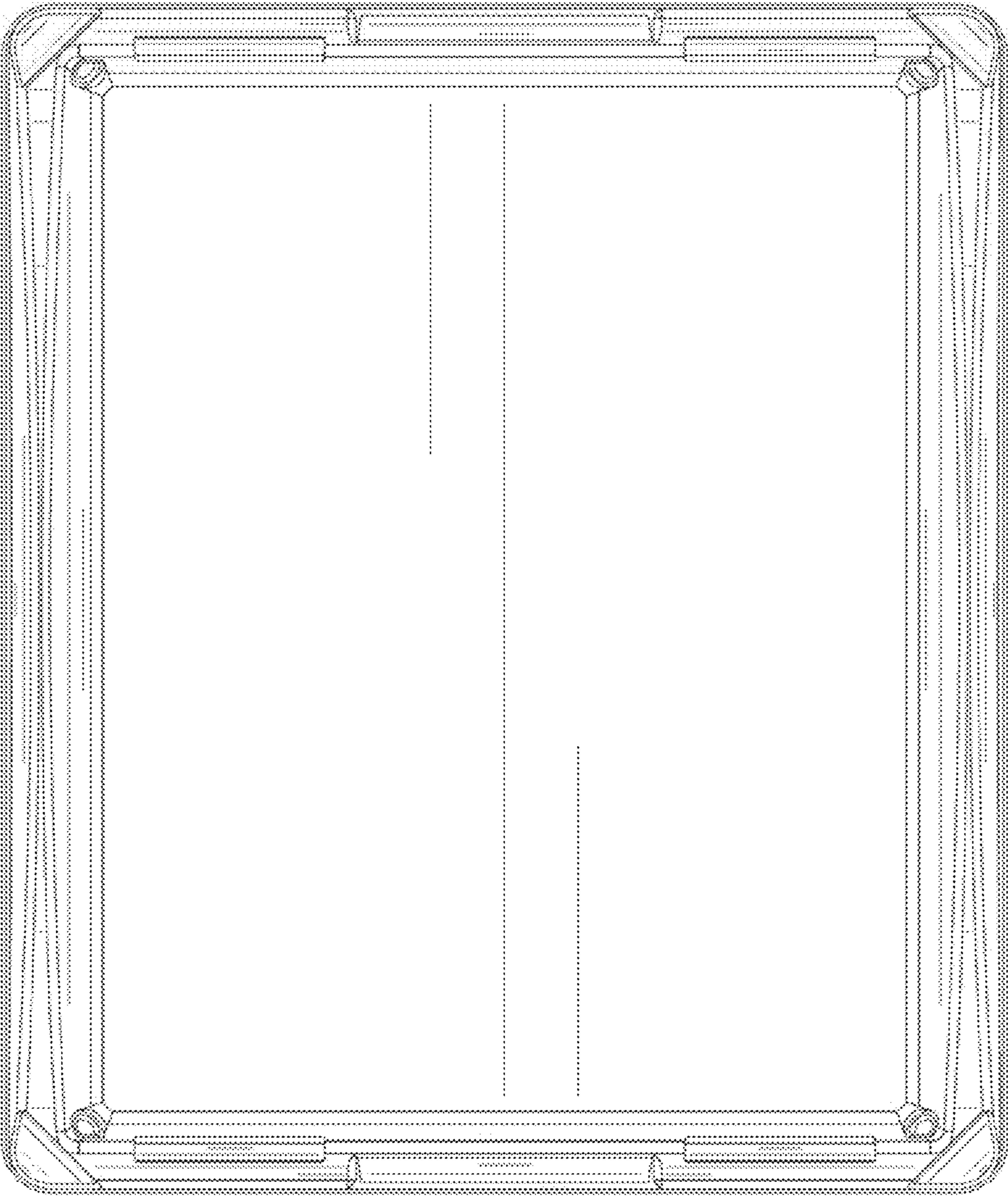

FIG. 6

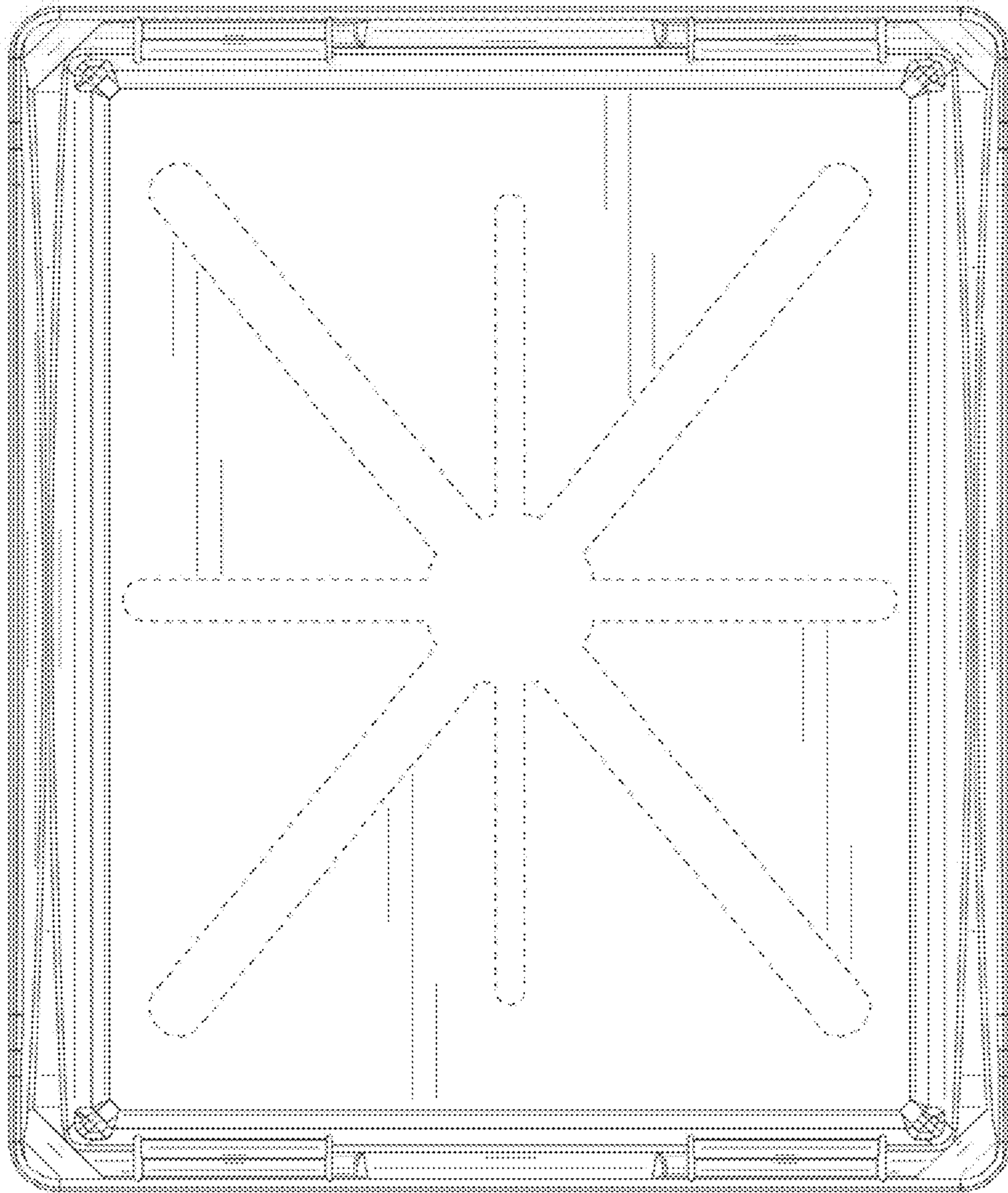

FIG. 7