



US00D682493S

(12) **United States Design Patent**
Erlich et al.

(10) **Patent No.:** **US D682,493 S**

(45) **Date of Patent:** **** May 14, 2013**

(54) **POOL VACUUM**

(75) Inventors: **Guy Erlich**, Monroe Two, NJ (US);
Jonathan Elmaleh, Brooklyn, NY (US)

(73) Assignee: **Water Tech LLC**, East Brunswick, NJ
(US)

(**) Term: **14 Years**

(21) Appl. No.: **29/374,411**

(22) Filed: **Aug. 8, 2011**

(51) **LOC (9) Cl.** **15-05**

(52) **U.S. Cl.**
USPC **D32/18**

(58) **Field of Classification Search** D32/17-18,
D32/22, 31; 15/320-321, 350-354, 415.1-422,
15/329, 344, 361, 410-411, 347, 1.7, DIG. 1;
55/DIG. 3, 429, 459.1, 246.4; 210/169, 167.17;
4/490

See application file for complete search history.

(56) **References Cited**

U.S. PATENT DOCUMENTS

5,338,446	A *	8/1994	Schuman et al.	210/167.15
5,970,557	A *	10/1999	Supra	15/1.7
D443,960	S *	6/2001	Shimko et al.	D32/18
D485,652	S *	1/2004	Erlich	D32/18
D518,253	S *	3/2006	Erlich et al.	D32/18
D522,191	S *	5/2006	Erlich	D32/18
D528,715	S *	9/2006	Carr	D32/18
D556,396	S *	11/2007	Mah et al.	D32/18
D569,058	S *	5/2008	Crawley	D32/18
D620,652	S *	7/2010	Butts et al.	D32/18

2004/0079690	A1 *	4/2004	Erlich	210/169
2004/0117940	A1 *	6/2004	Kim	15/344
2005/0035039	A1 *	2/2005	Erlich	210/169

* cited by examiner

Primary Examiner — Ruth McInroy

(74) *Attorney, Agent, or Firm* — Abelman, Frayne & Schwab

(57) **CLAIM**

The ornamental design for a pool vacuum, as shown and described.

DESCRIPTION

FIG. 1 is a top, rear, left side perspective view of a first embodiment of the pool vacuum showing our new design; FIG. 2 is a top plan view thereof; FIG. 3 is a front elevational view thereof; FIG. 4 is a left side elevational view thereof; FIG. 5 is a right side elevational view thereof; FIG. 6 is a rear elevational view thereof; FIG. 7 is a bottom plan view thereof; FIG. 8 is a top, rear, left side perspective view of a second embodiment of the pool vacuum showing our new design; FIG. 9 is a top plan view thereof; FIG. 10 is a front elevational view thereof; FIG. 11 is a left side elevational view thereof; FIG. 12 is a right side elevational view thereof; FIG. 13 is a rear elevational view thereof; and, FIG. 14 is a bottom plan view thereof.

The broken lines showing structural elements in the drawings are included for the purpose of illustrating non-claimed subject matter, and form no part of the claimed design.

1 Claim, 14 Drawing Sheets

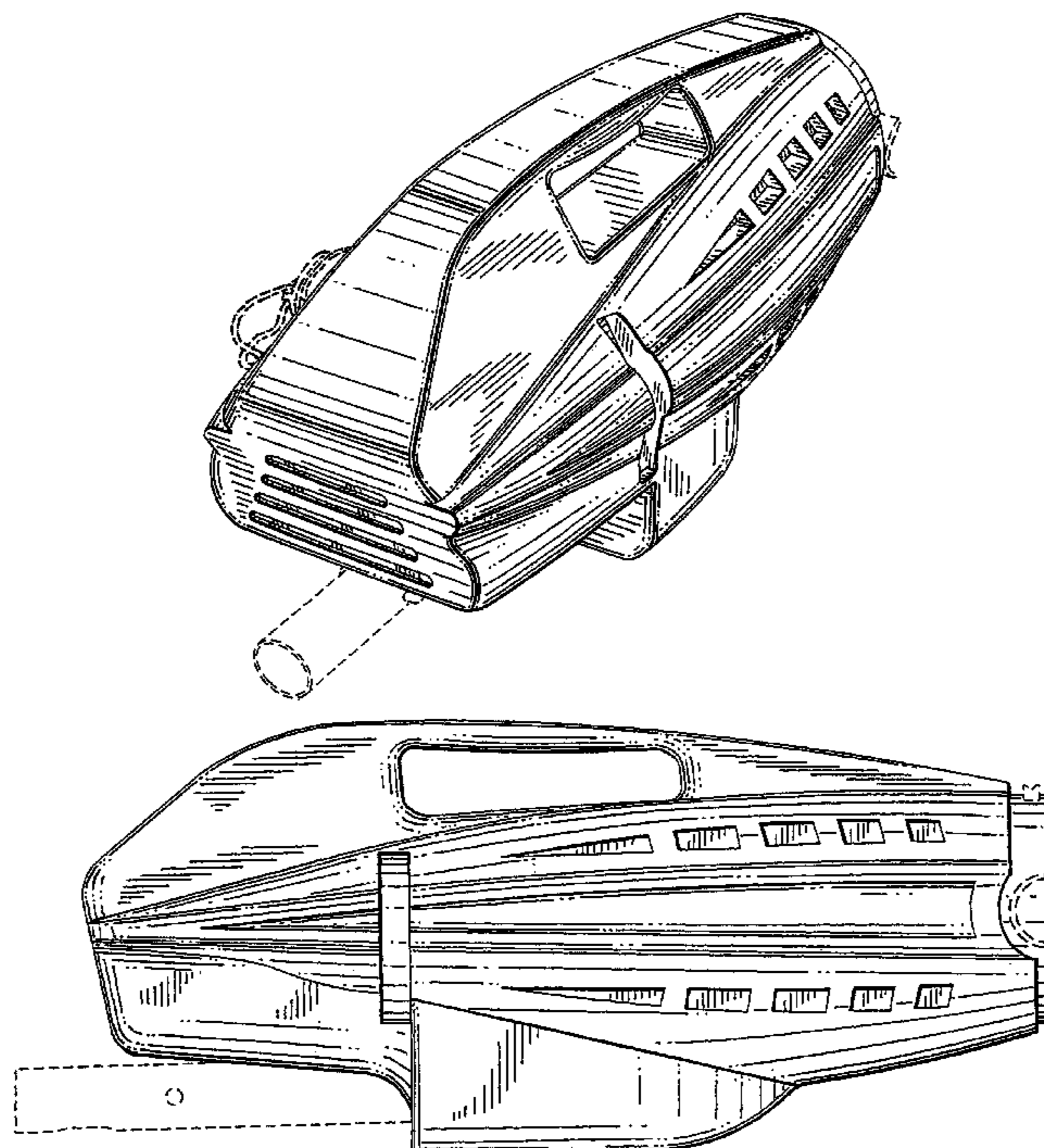

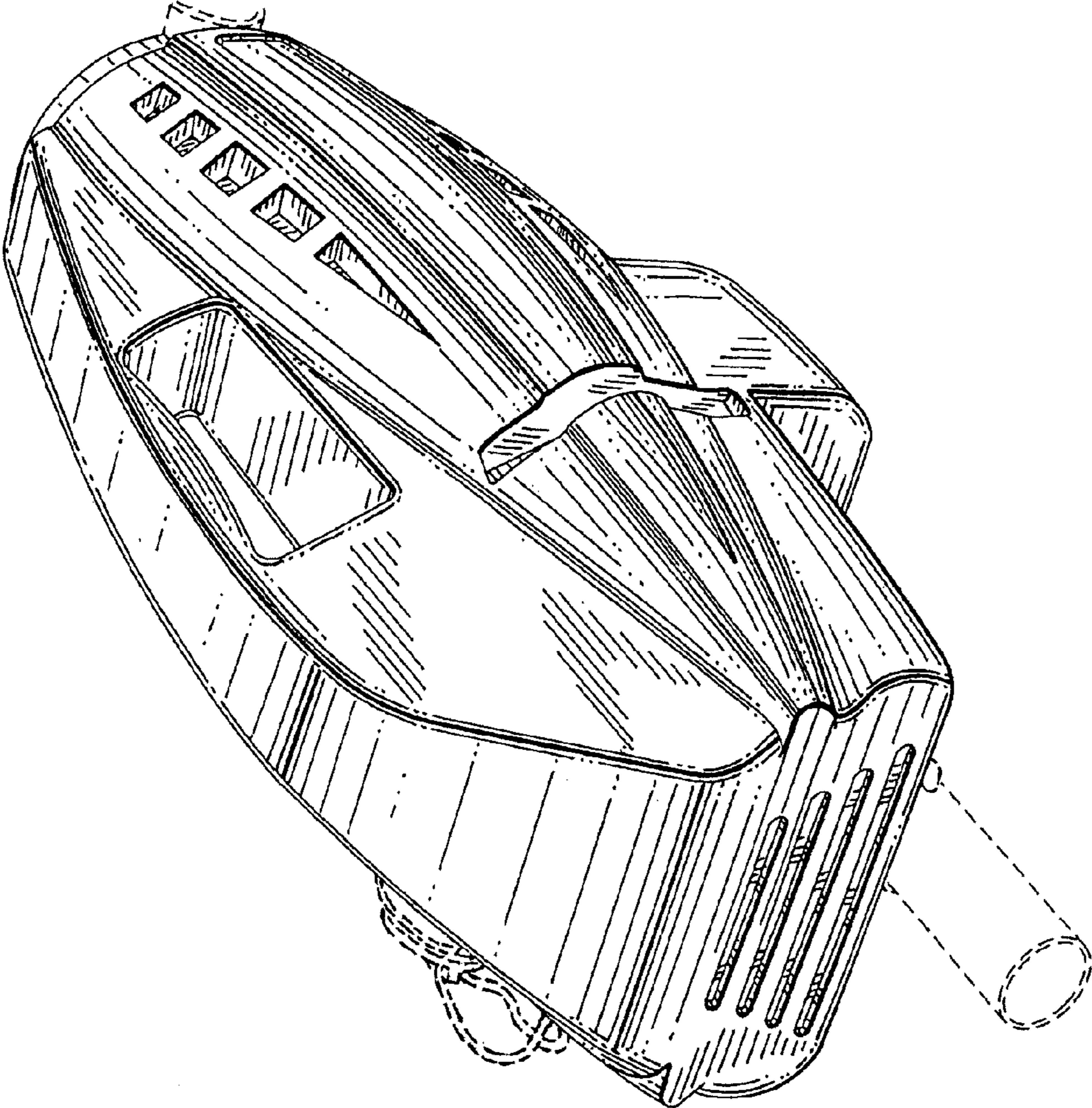

FIG. 1

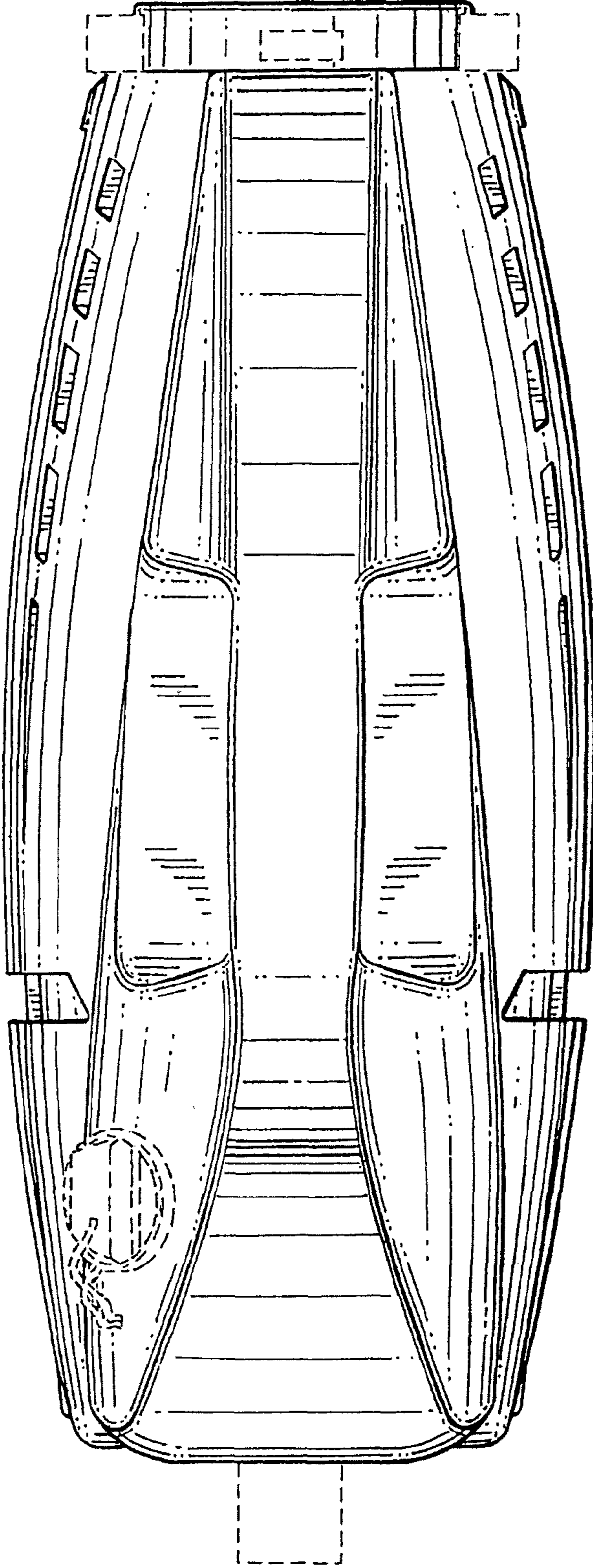

FIG. 2

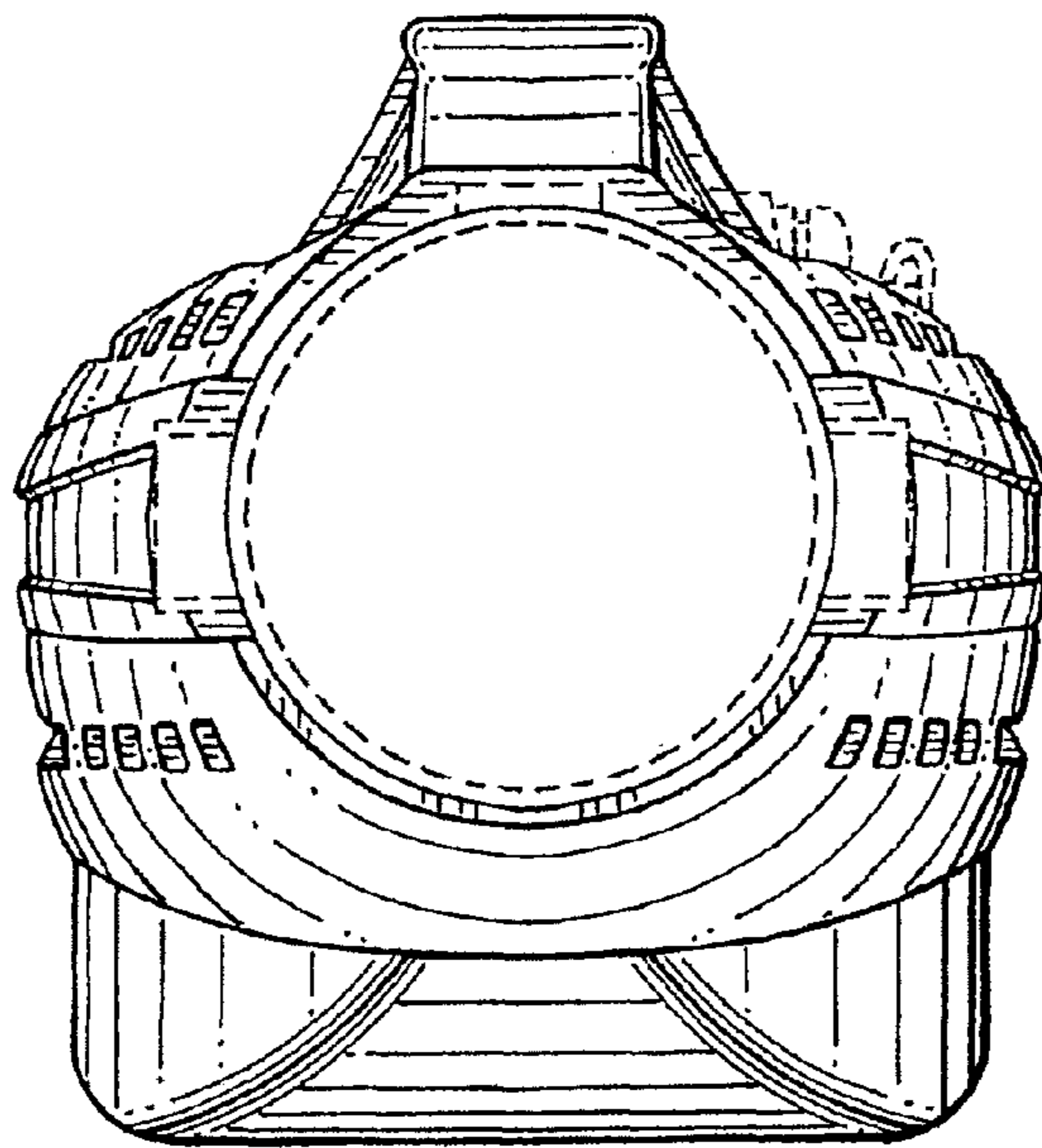

FIG. 3

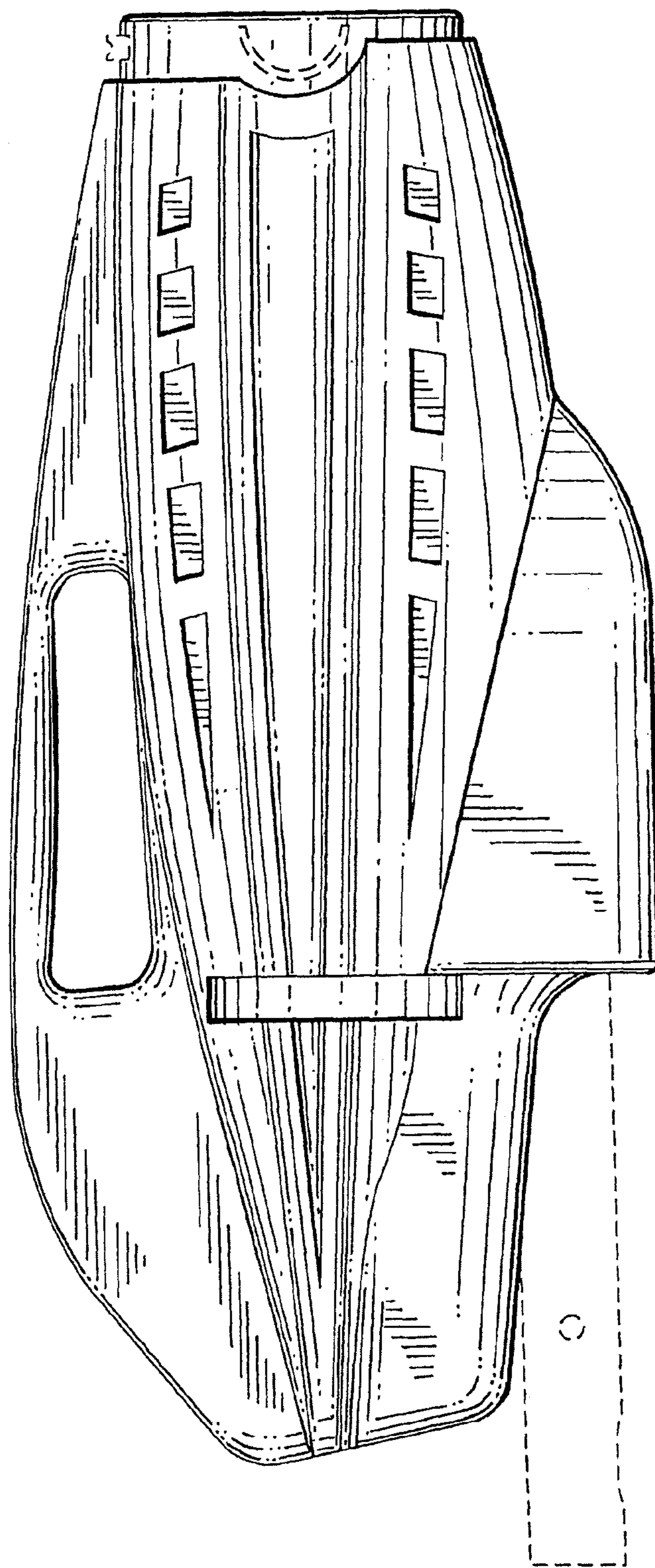

FIG. 4

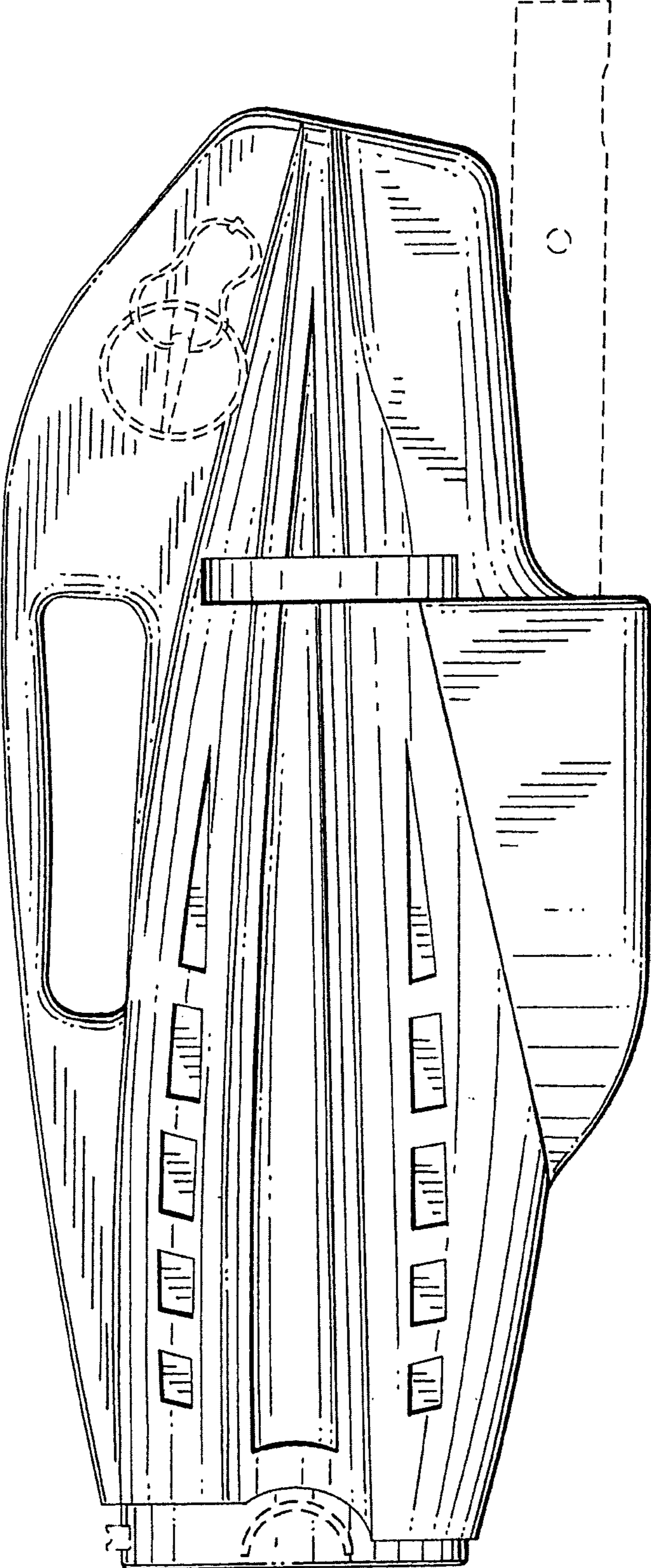

FIG. 5

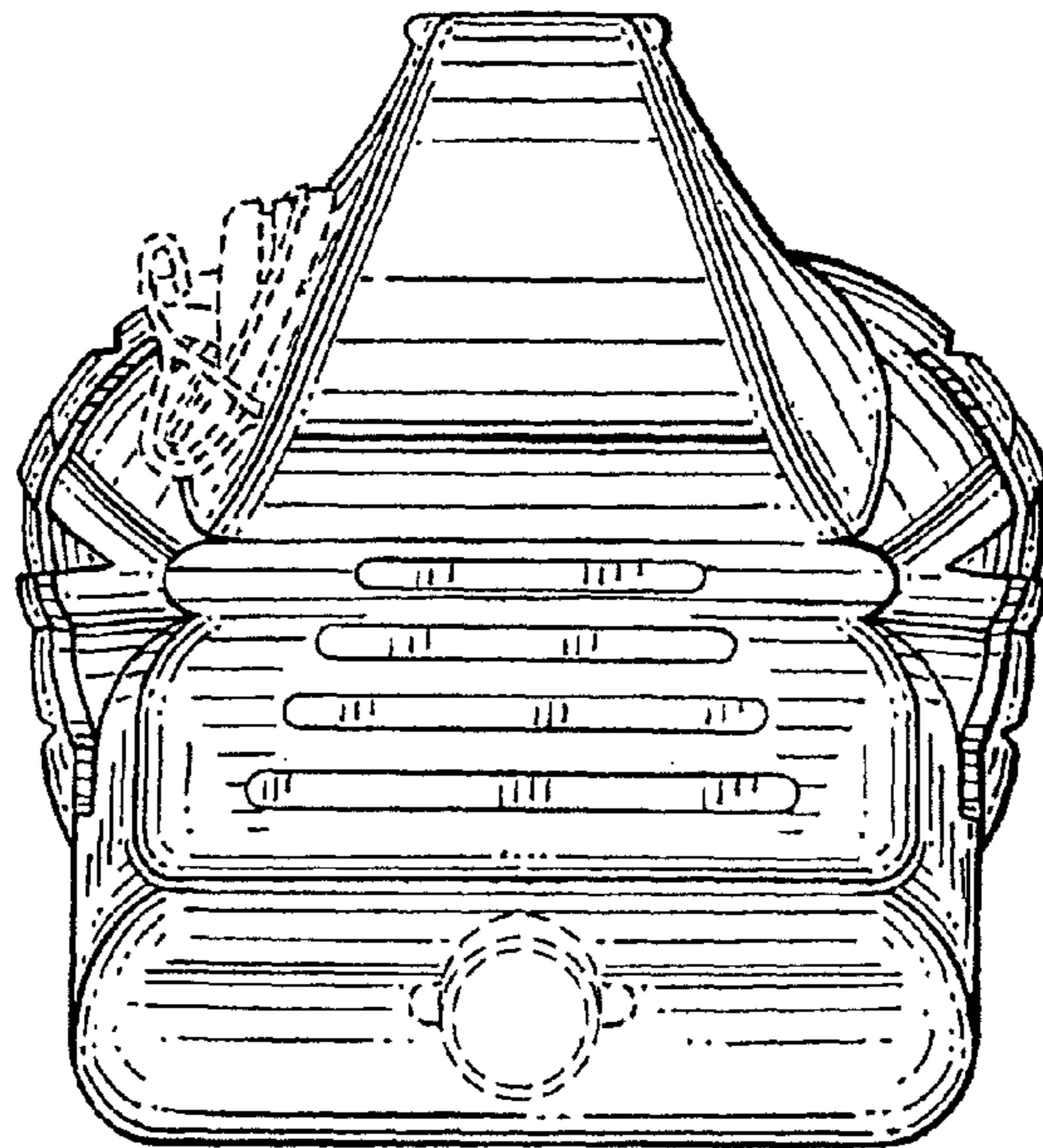

FIG. 6

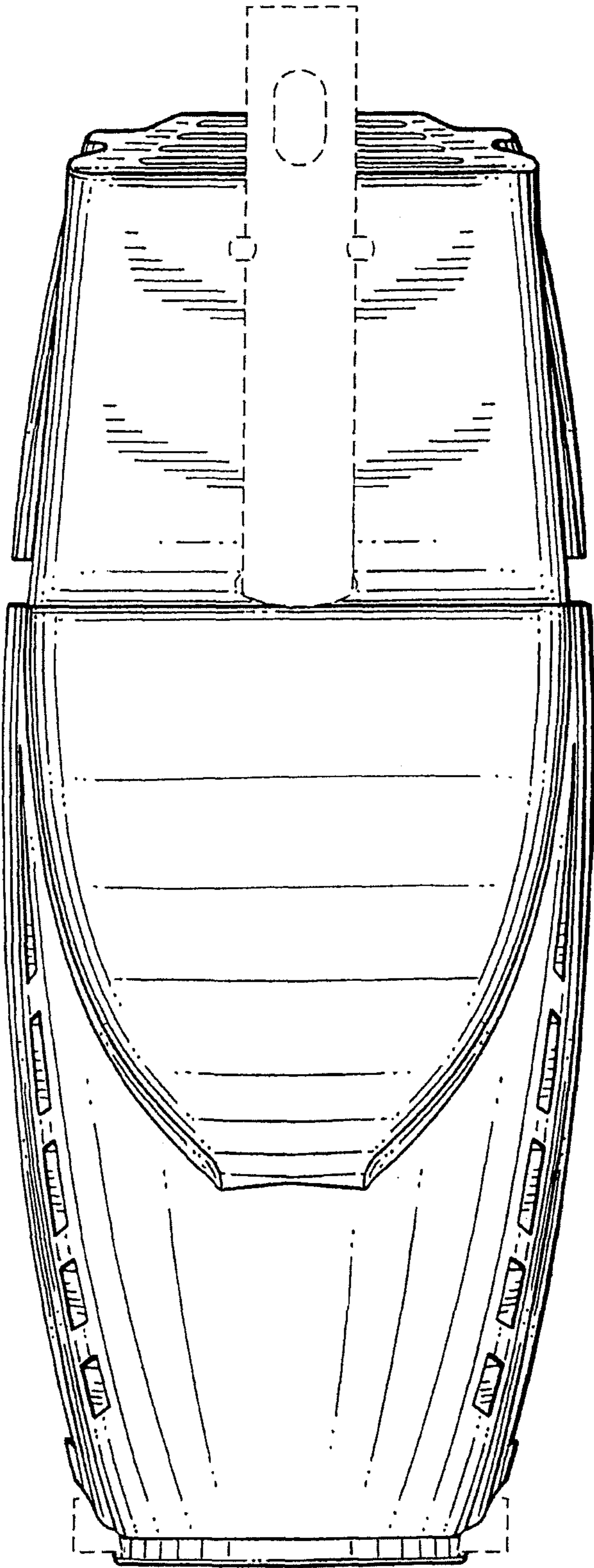

FIG. 7

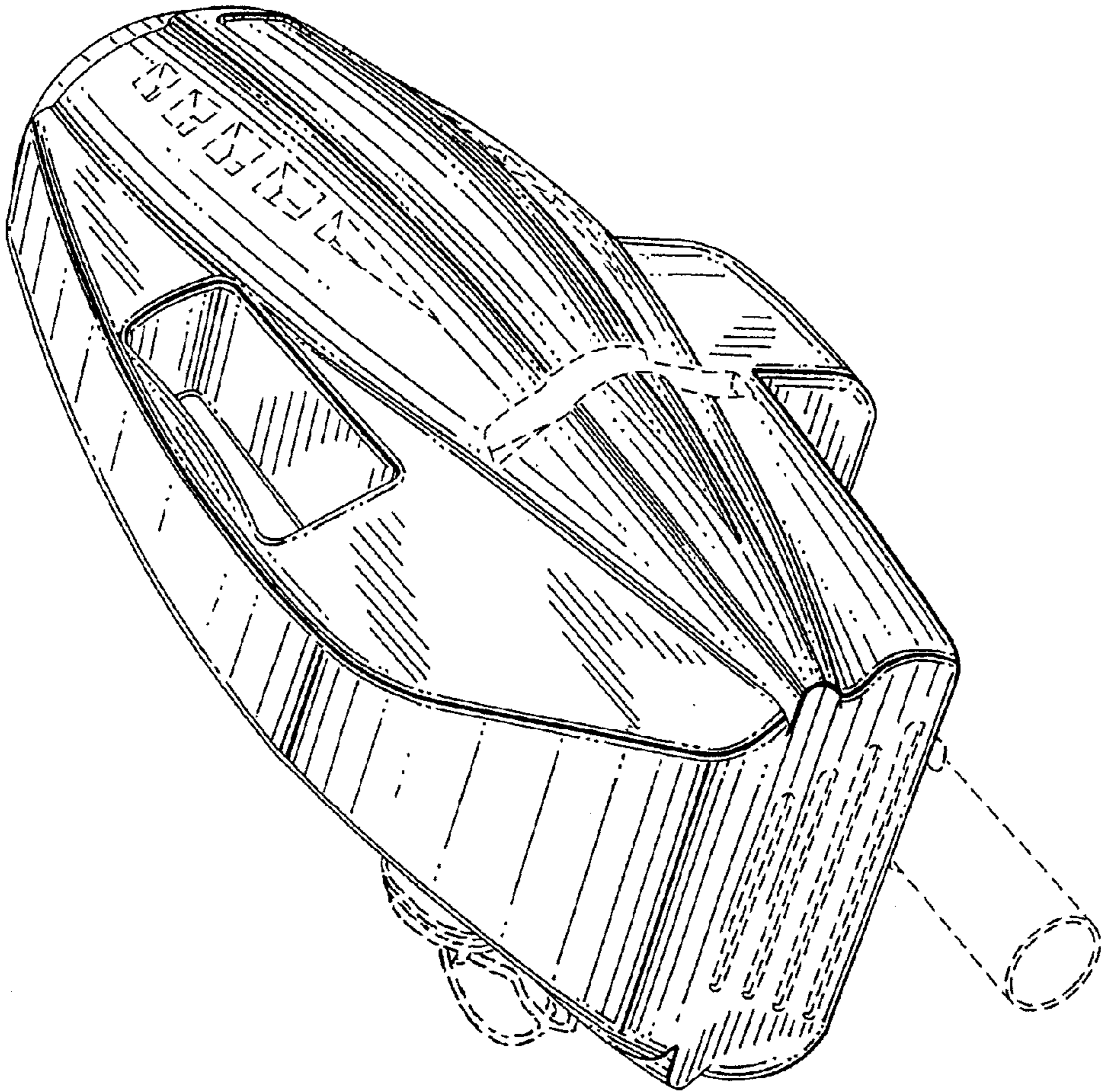

FIG. 8

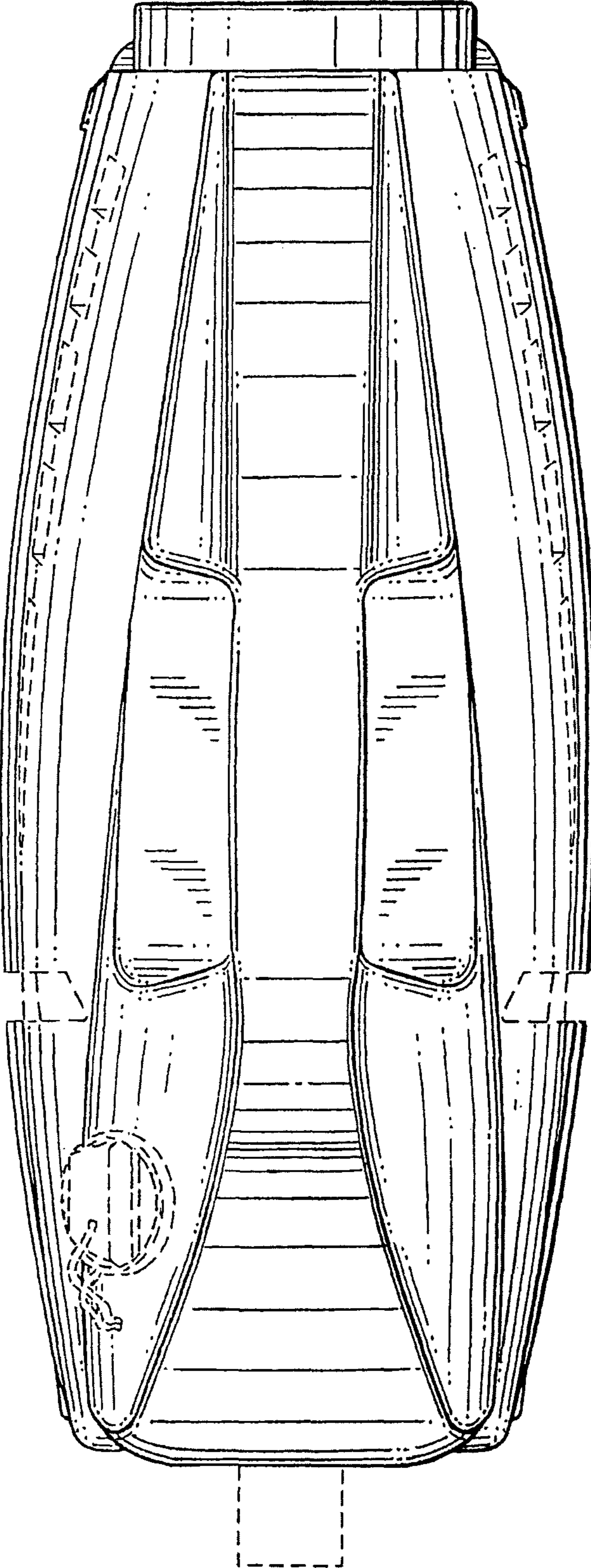

FIG. 9

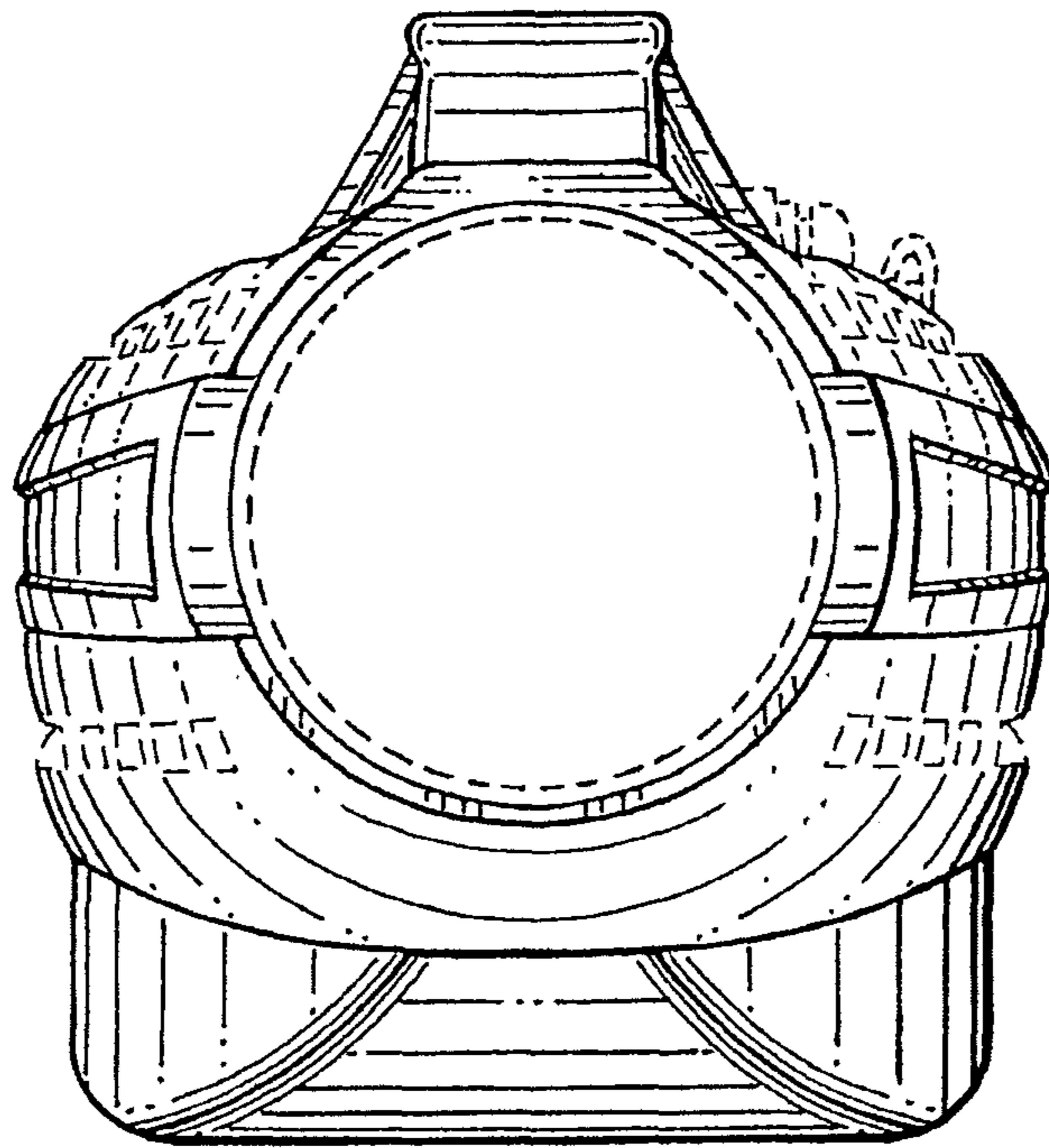

FIG. 10

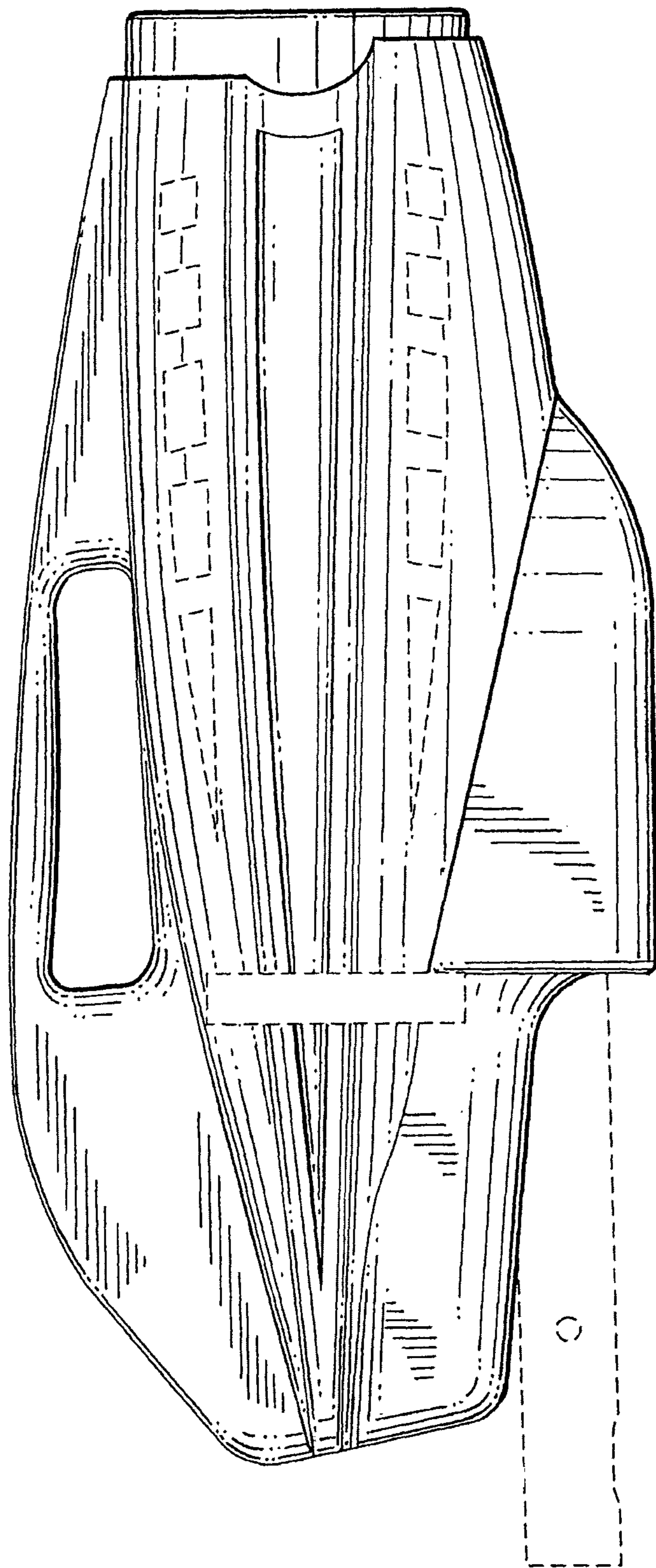

FIG. 11

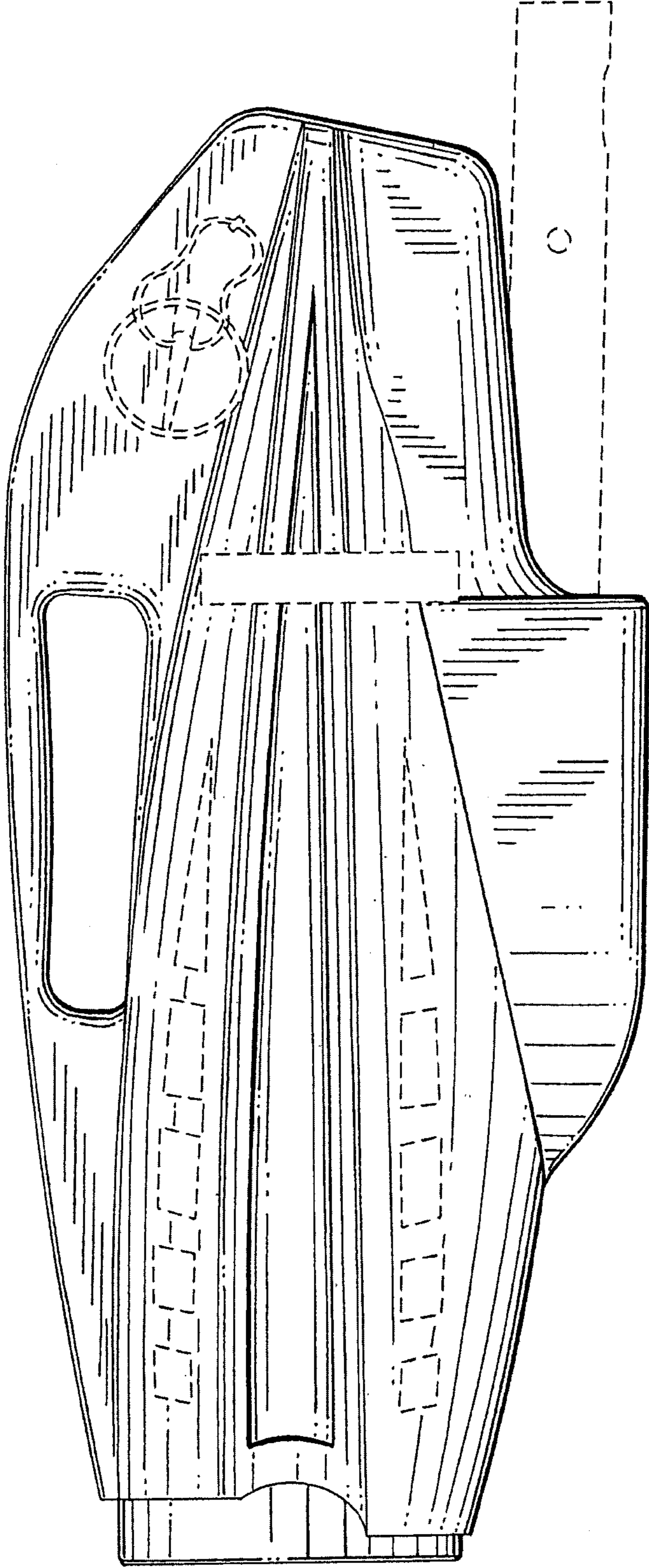

FIG. 12

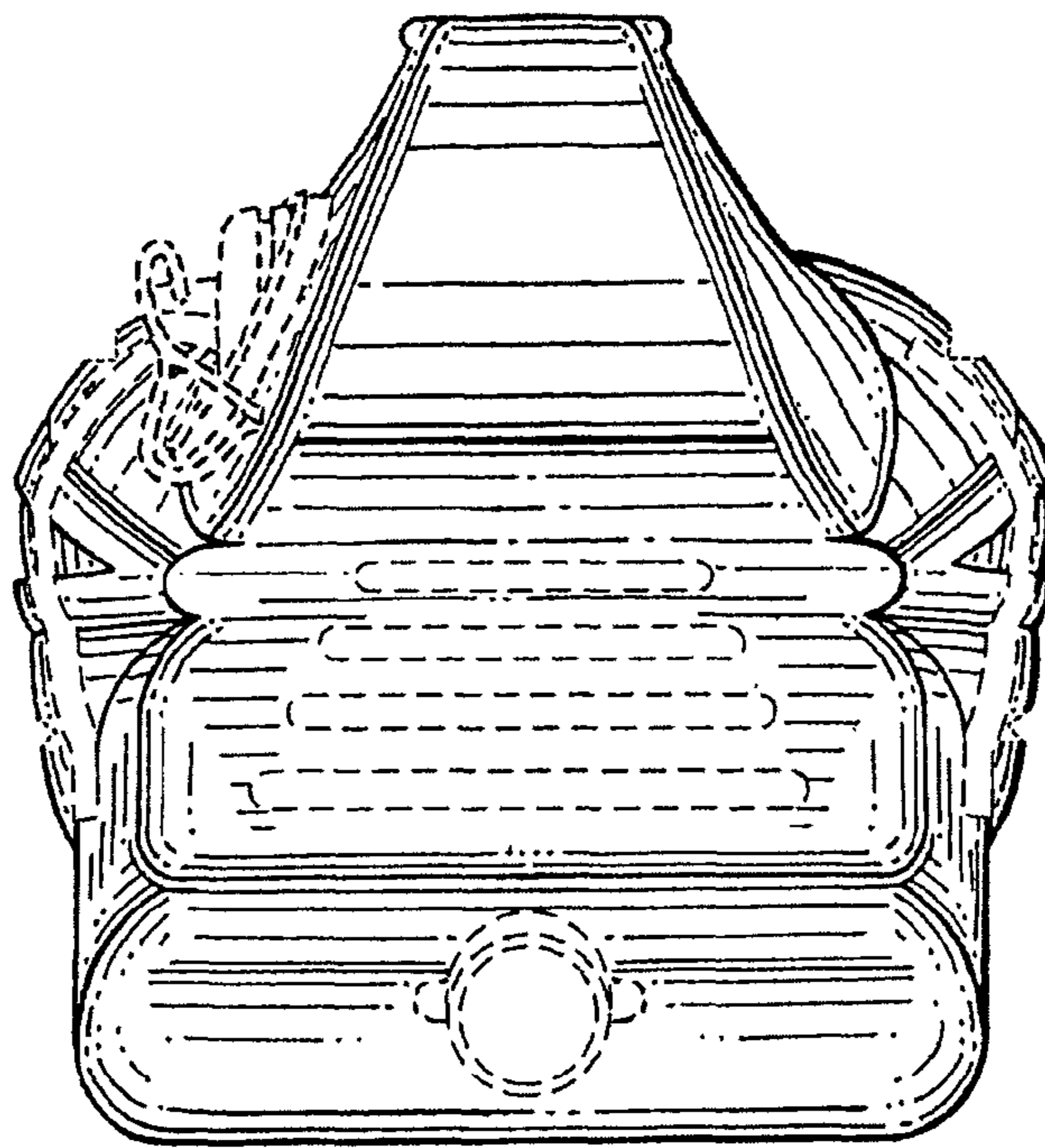

FIG. 13

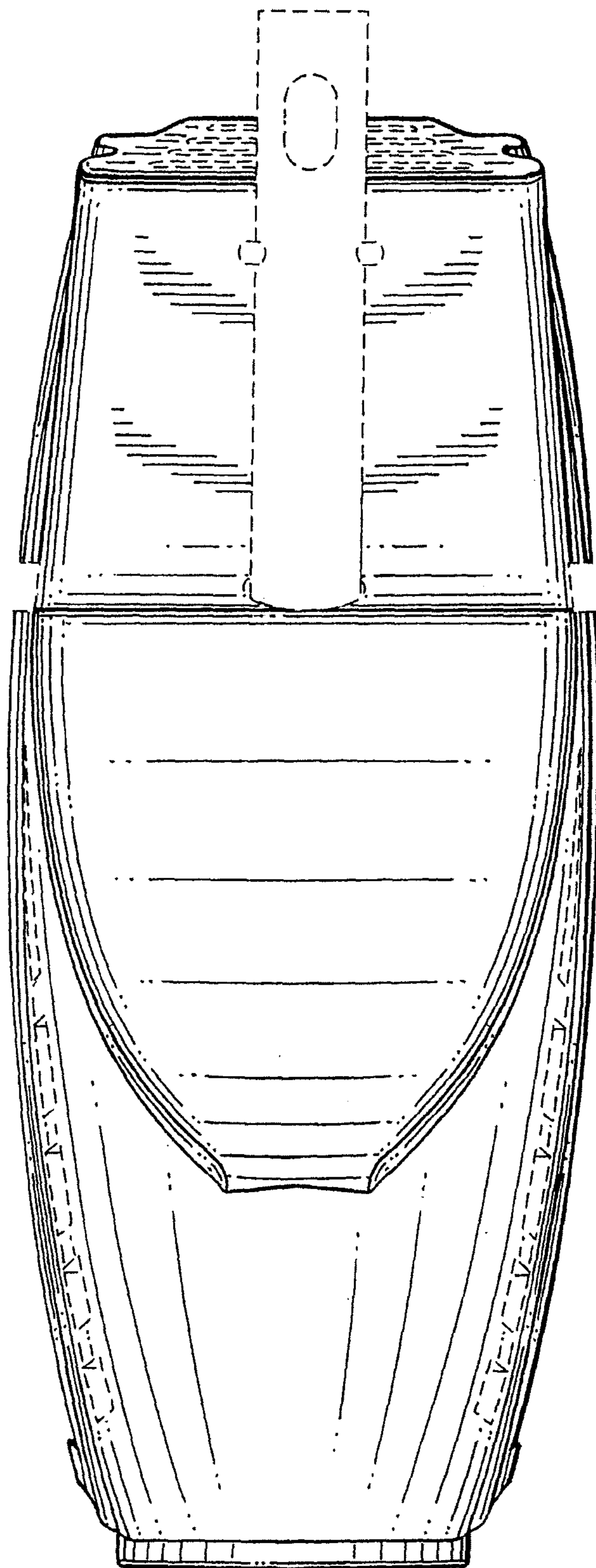

FIG. 14