



US00D682476S

(12) **United States Design Patent**  
**Chen et al.**

(10) **Patent No.:** **US D682,476 S**

(45) **Date of Patent:** **\*\* May 14, 2013**

(54) **LIPSTICK CASE**

(75) Inventors: **I-Ming Chen**, Tainan (TW); **Hsuan-Yu Chen**, Tainan (TW)

(73) Assignee: **Tair Jih Enterprise Co., Ltd.**, Tainan (TW)

(\*\*) Term: **14 Years**

(21) Appl. No.: **29/416,440**

(22) Filed: **Mar. 22, 2012**

(30) **Foreign Application Priority Data**

Sep. 23, 2011 (TW) ..... 100305036

(51) **LOC (9) Cl.** ..... **28-03**

(52) **U.S. Cl.**  
USPC ..... **D28/85**

(58) **Field of Classification Search** ..... D28/85-90;  
D9/503-504; 132/318, 320; 206/581, 823,  
206/385; 401/68-79

See application file for complete search history.

(56) **References Cited**

U.S. PATENT DOCUMENTS

D276,500	S	*	11/1984	Shend'ge et al.	.....	D9/505
D341,227	S	*	11/1993	Lang et al.	.....	D28/76
D347,297	S	*	5/1994	Vesco	.....	D28/77
D491,692	S	*	6/2004	Schlatter	.....	D28/76
6,923,589	B2	*	8/2005	Blackwell	.....	401/131
D539,482	S	*	3/2007	Koch	.....	D28/90

\* cited by examiner

*Primary Examiner* — Jennifer Rivard

(74) *Attorney, Agent, or Firm* — Whyte Hirschboeck Dudek SC

(57) **CLAIM**

The ornamental design for lipstick case, as shown and described.

**DESCRIPTION**

FIG. 1 is a perspective view of lipstick case showing our new design;  
FIG. 2 is a front elevational view thereof;  
FIG. 3 is a rear elevational view thereof;  
FIG. 4 is a left side elevational view thereof;  
FIG. 5 is a right side elevational view thereof;  
FIG. 6 is a top plan view thereof; and,  
FIG. 7 is a bottom plan view thereof.

**1 Claim, 4 Drawing Sheets**

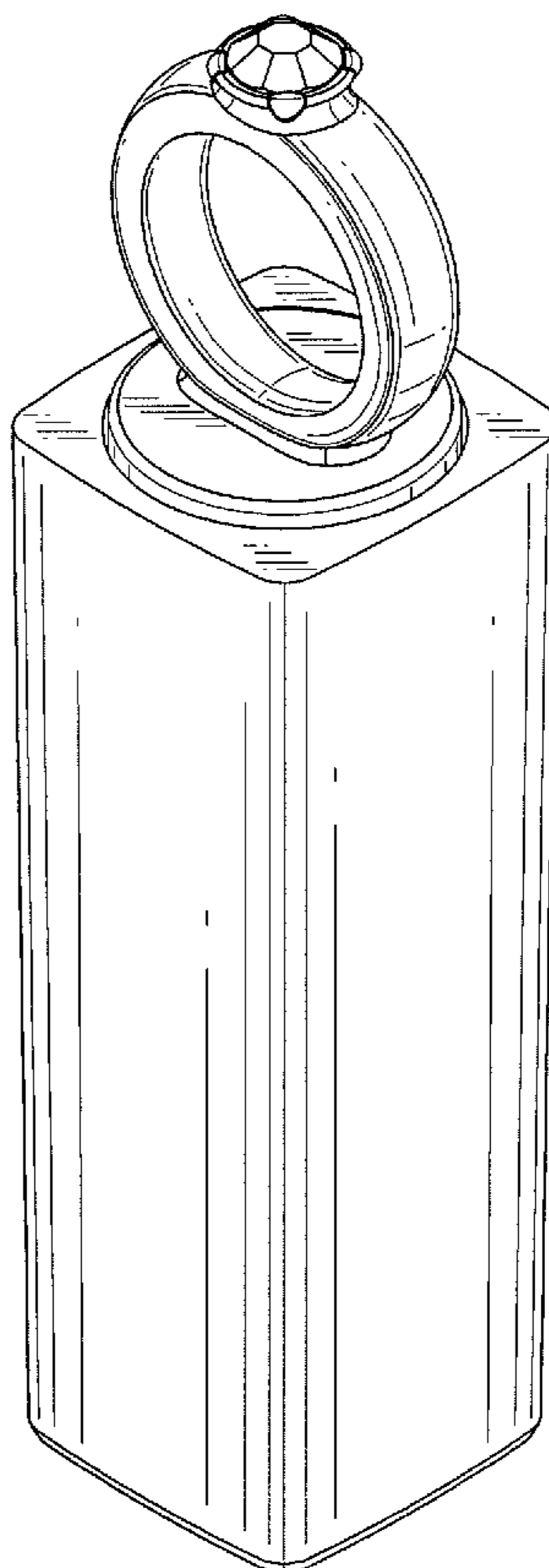

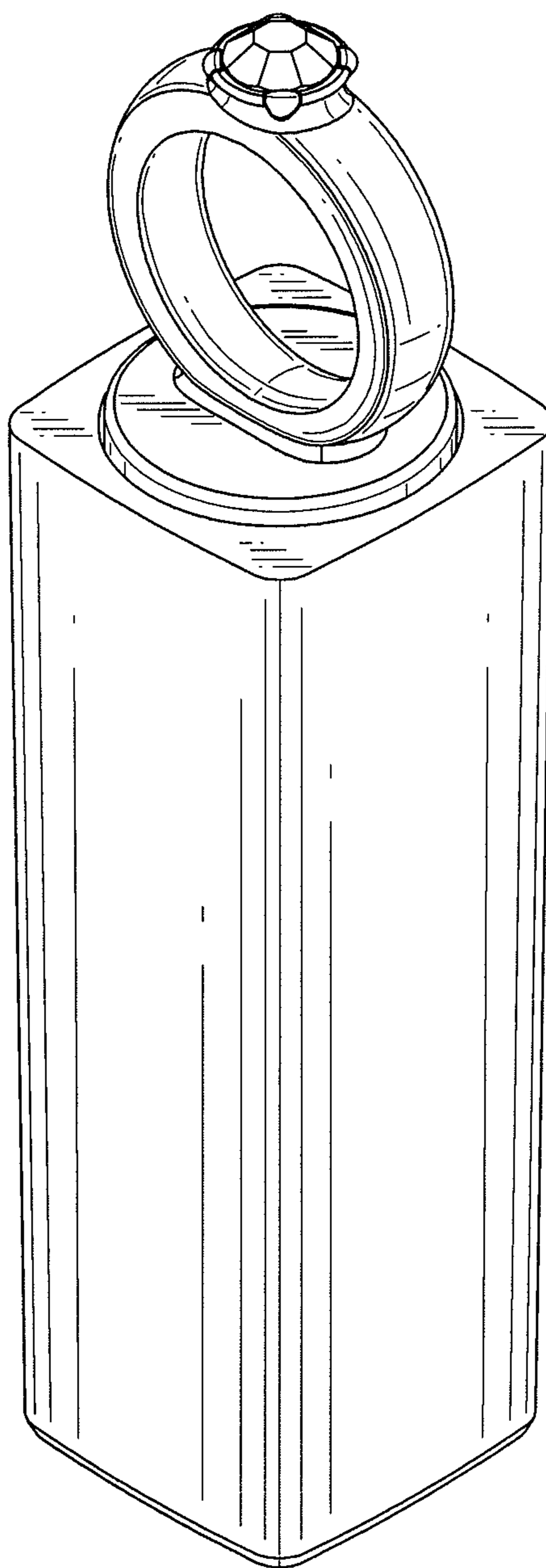

FIG. 1

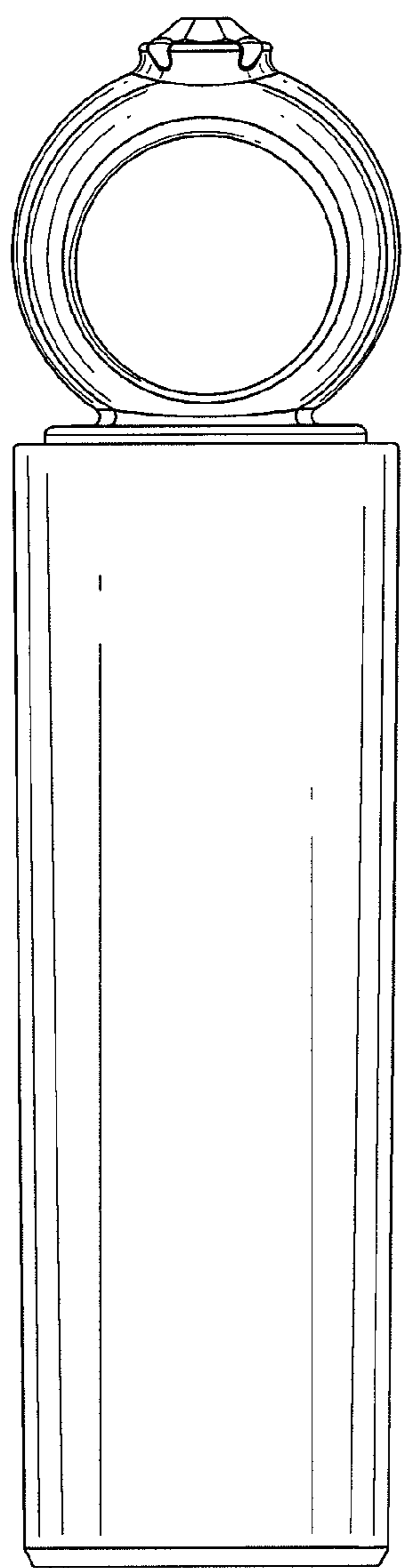

FIG. 2

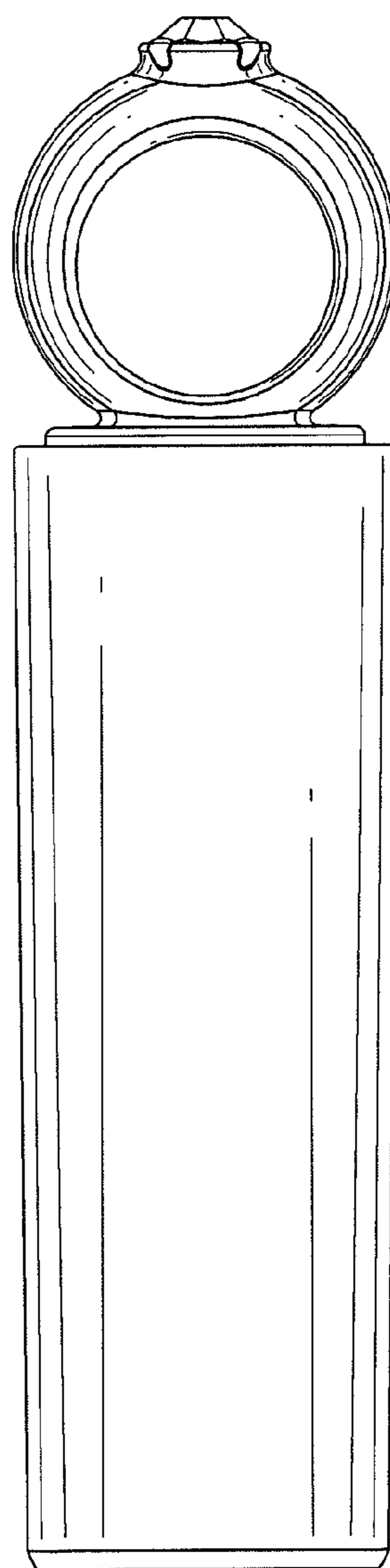

FIG. 3

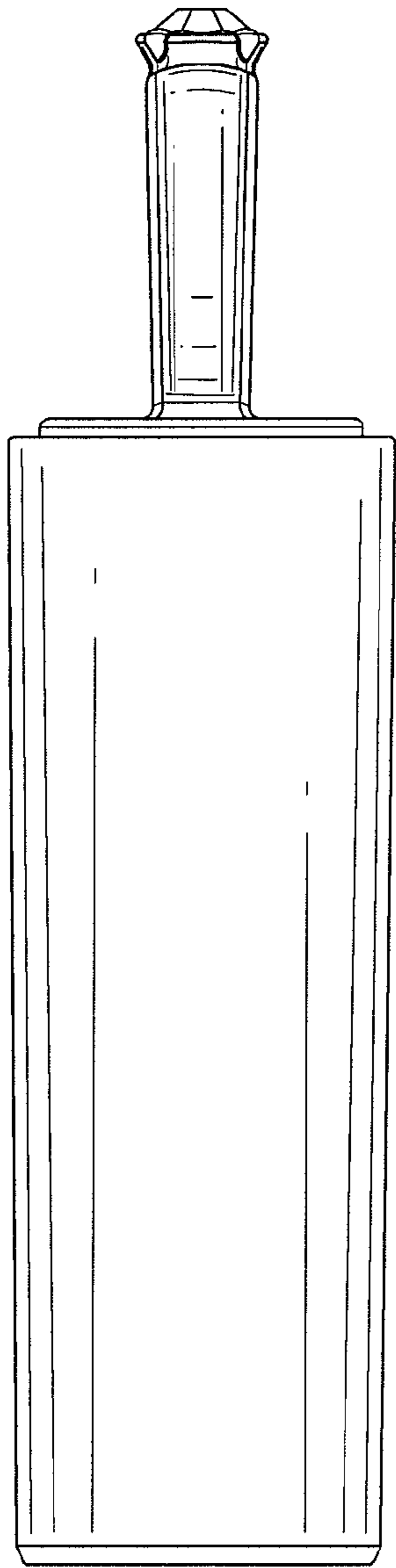

FIG. 4

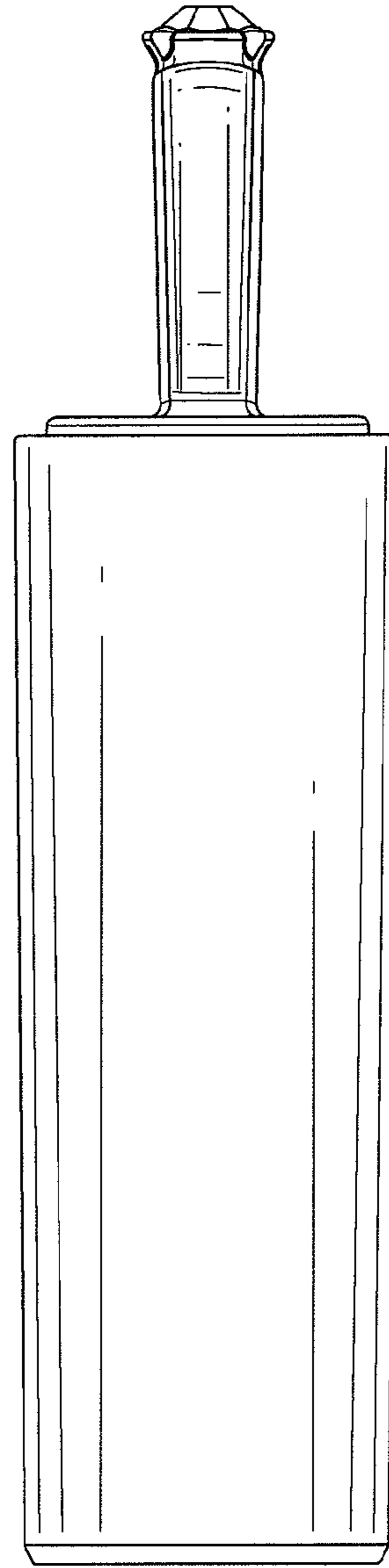

FIG. 5

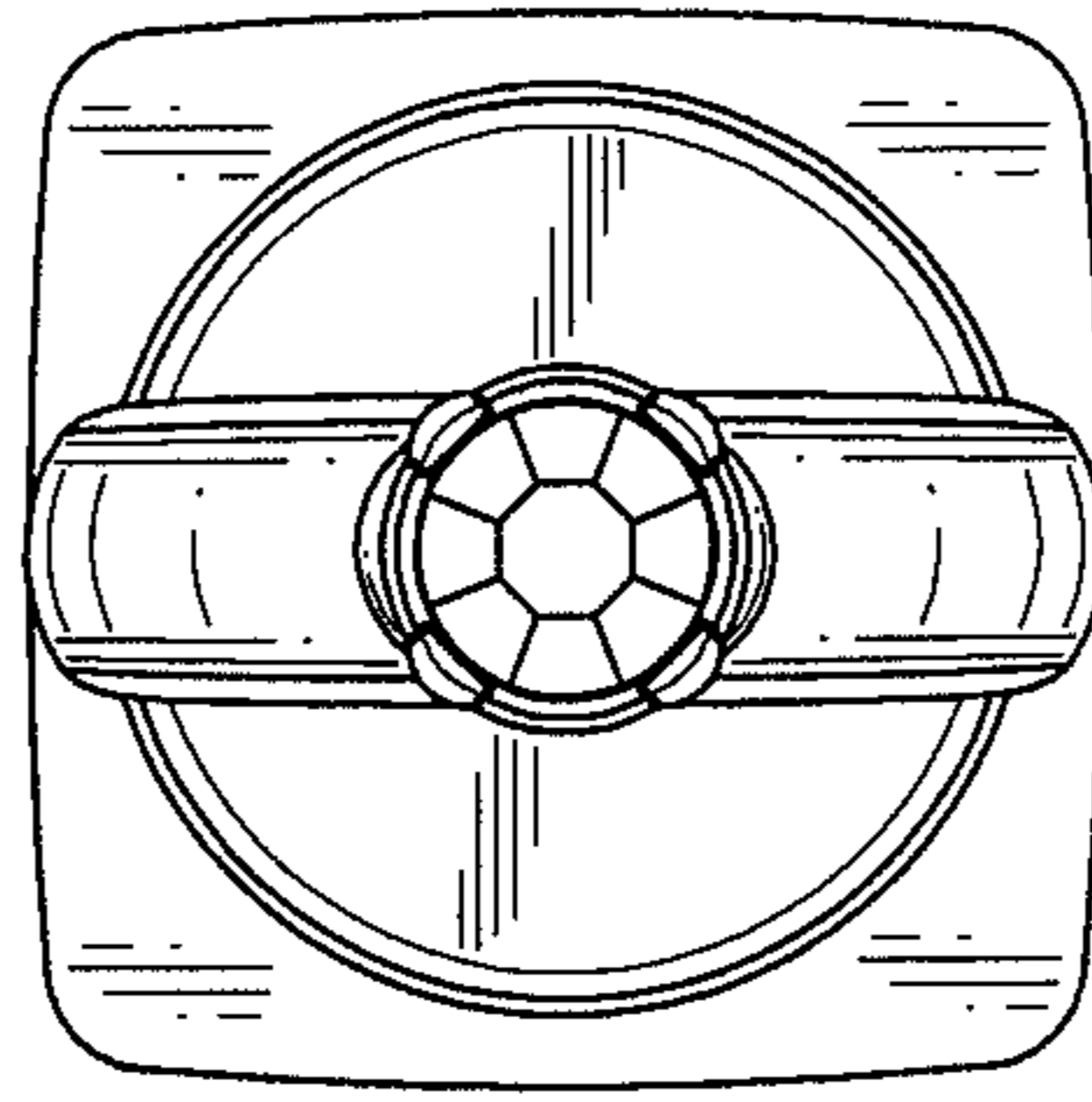

FIG. 6

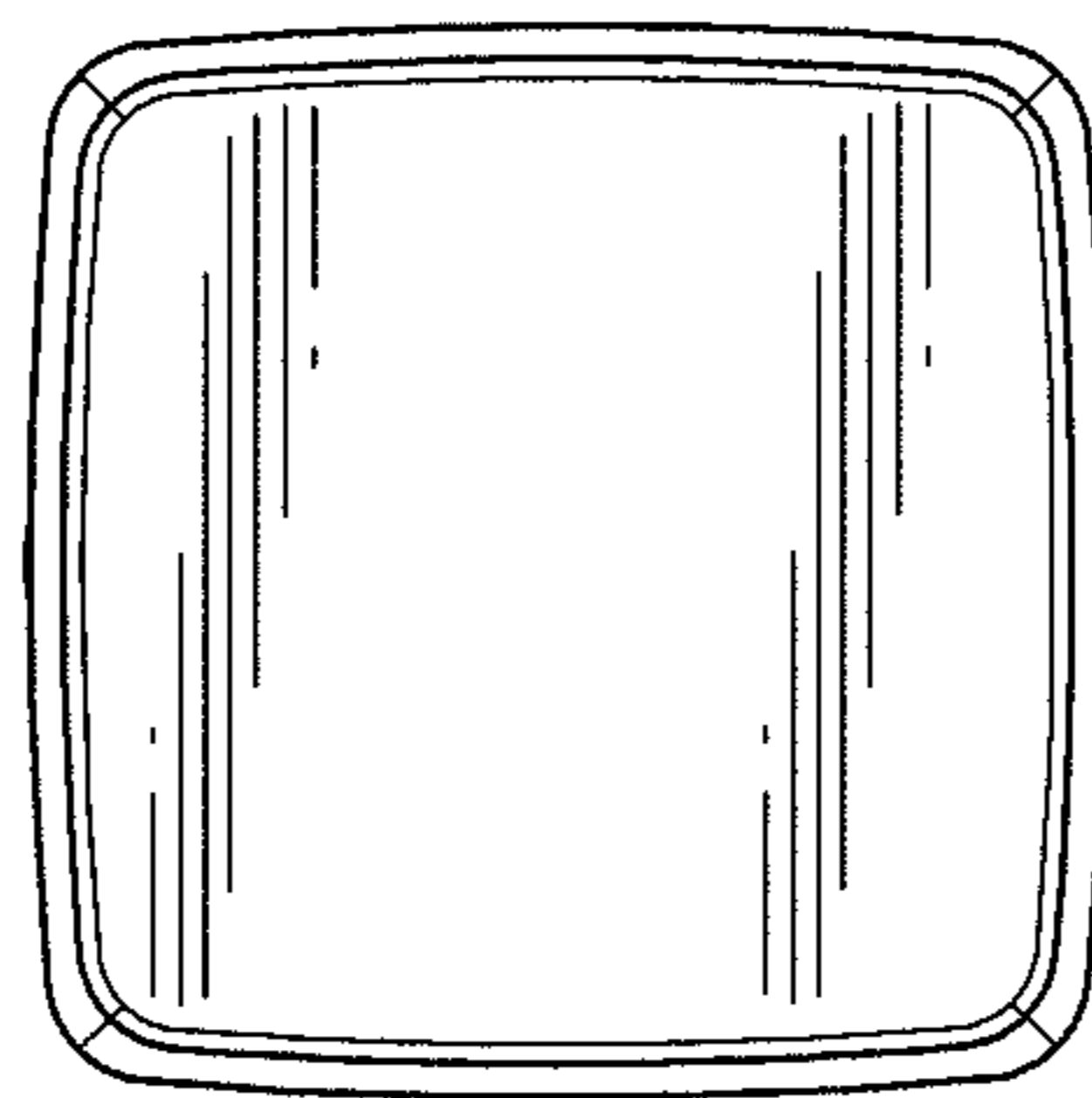

FIG. 7