



US00D682435S

(12) **United States Design Patent**
Lowsky, Jr.

(10) **Patent No.:** **US D682,435 S**
(45) **Date of Patent:** **** May 14, 2013**

(54) **ORAL-MOTOR THERAPY DEVICE**

(75) Inventor: **John Lowsky, Jr.**, Columbia, SC (US)

(73) Assignee: **ARK Therapeutic Services, Inc.**,
Lugoff, SC (US)

(**) Term: **14 Years**

(21) Appl. No.: **29/422,606**

(22) Filed: **May 22, 2012**

(51) **LOC (9) Cl.** **24-04**

(52) **U.S. Cl.**
USPC **D24/194; D24/193**

(58) **Field of Classification Search** D24/115,
D24/117, 193-196, 199, 200, 211, 214;
606/234-236; 215/11.1-11.6; D30/160;
604/77; 119/707, 710, 711; 24/3.1, 3.4,
24/3.13, 301; D21/659, 660, 661

See application file for complete search history.

(56) **References Cited**

U.S. PATENT DOCUMENTS

D136,206 S *	8/1943	Allen	D24/194
D155,689 S *	10/1949	Davis	D24/194
2,514,844 A *	7/1950	Cohen	606/235
D168,506 S *	12/1952	Hayes	D24/194
2,826,201 A *	3/1958	Yoder	606/235
D221,496 S *	8/1971	Herbst	D24/194
D400,256 S *	10/1998	Fagan	D24/194
D461,558 S *	8/2002	Schiavoni	D24/176
D522,658 S *	6/2006	Schiavoni	D24/194

D539,430 S	3/2007	Lowsky, Jr. et al.	
D552,745 S *	10/2007	Beckman D24/194
D598,118 S *	8/2009	Schiavoni D24/194
D673,284 S *	12/2012	Lowsky D24/214

OTHER PUBLICATIONS

ARK's Grabbers & Y-Chews, Catalog portion of ARK Therapeutic Services, Inc. Speech Therapy Tools and other Healthcare Products, Product Catalog 2011-2012.

* cited by examiner

Primary Examiner — Susan E Krawkower

(74) *Attorney, Agent, or Firm* — Nelson Mullins Riley & Scarborough LLP

(57) **CLAIM**

The ornamental design for an oral-motor therapy device, as shown and described.

DESCRIPTION

FIG. 1 is a front perspective view of a new, original, and ornamental design of an oral-motor therapy device in accordance with the present invention;
FIG. 2 is a right side elevation view thereof;
FIG. 3 is a left side elevation view thereof;
FIG. 4 is a bottom side plan view thereof;
FIG. 5 is a top side plan view thereof;
FIG. 6 is a front side elevation view thereof; and,
FIG. 7 is a back side elevation view thereof.
The broken lines illustrate portions of the oral-motor therapy device which form no part of the claimed design.

1 Claim, 7 Drawing Sheets

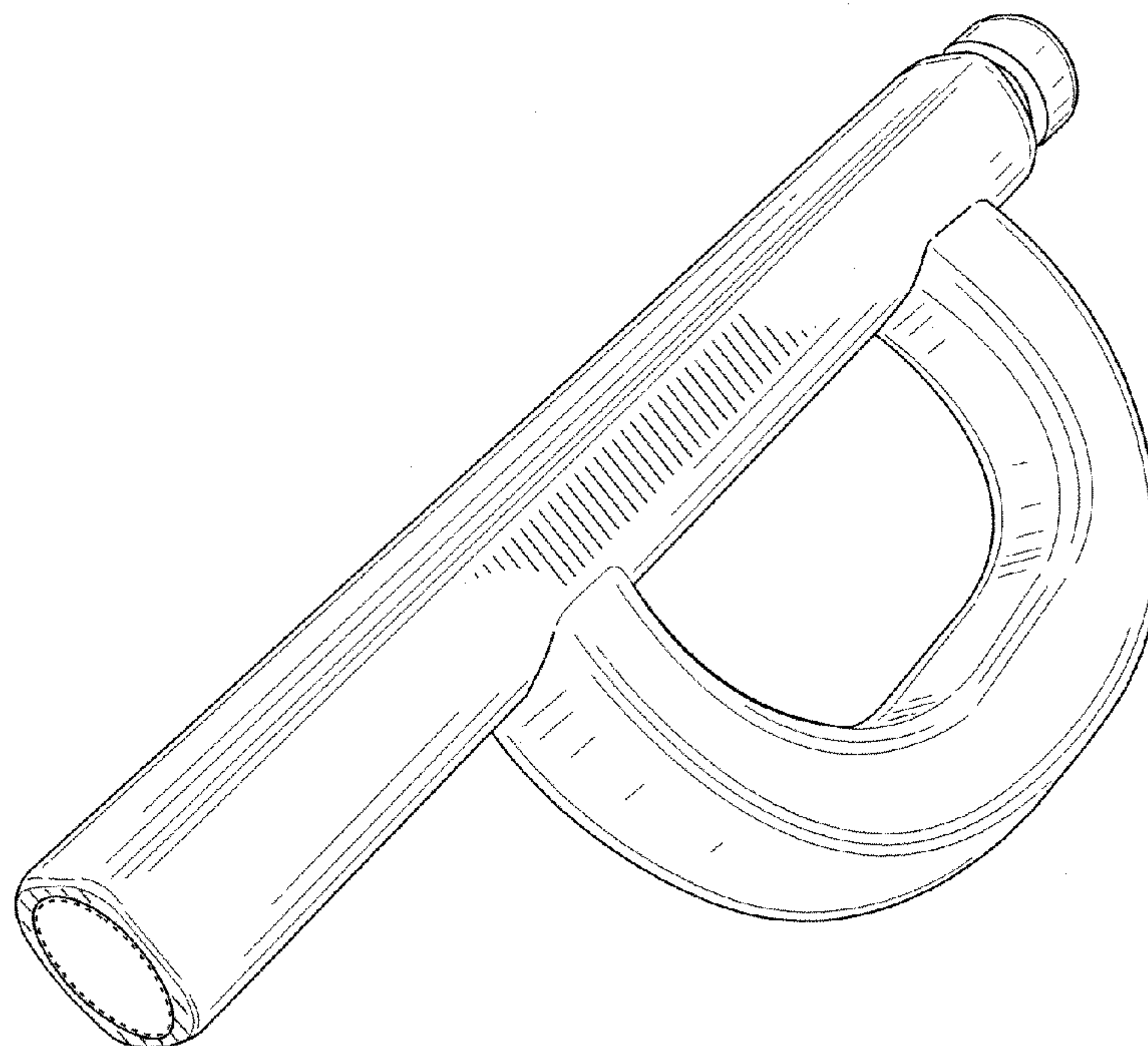

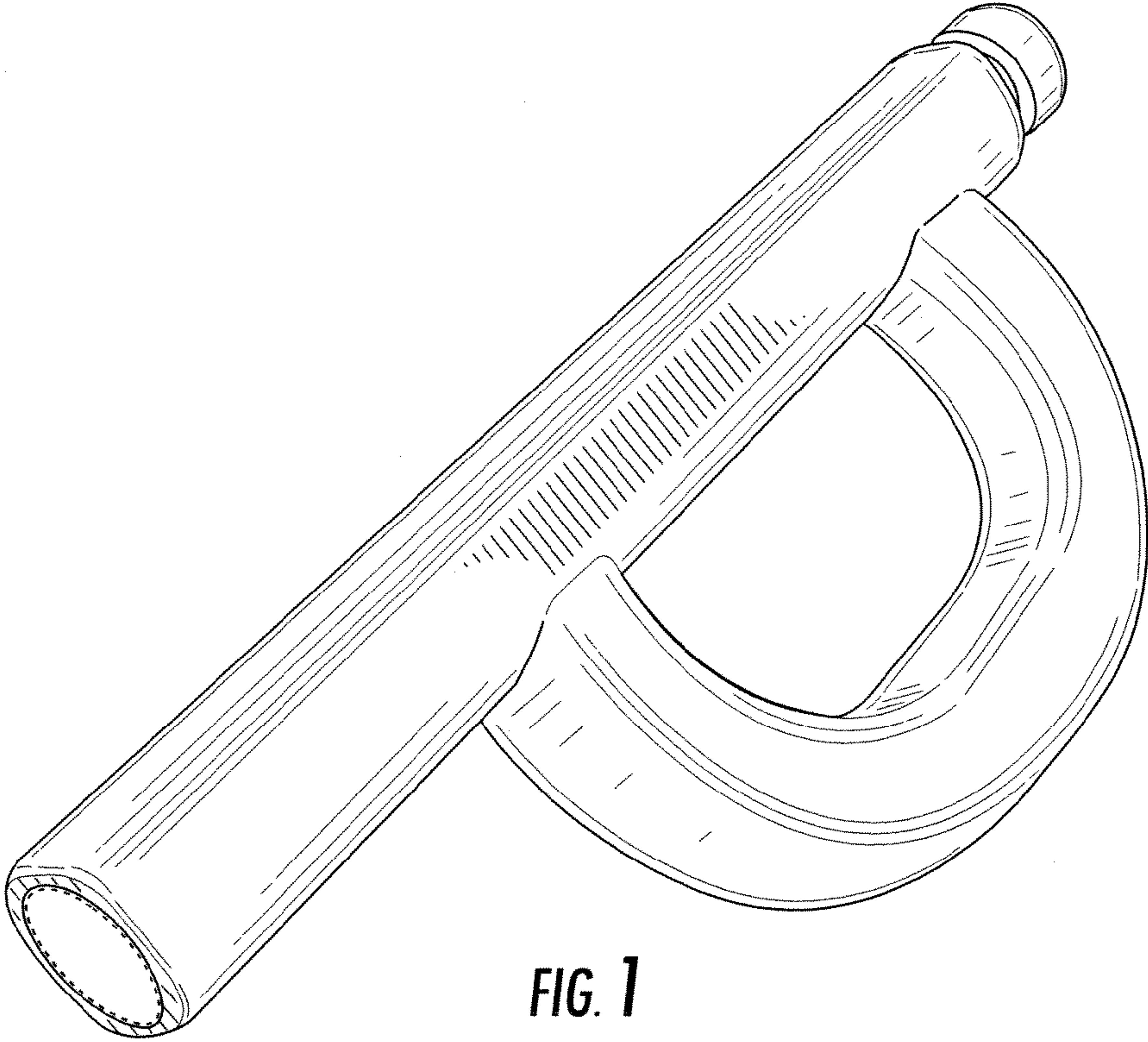

FIG. 1



FIG. 2

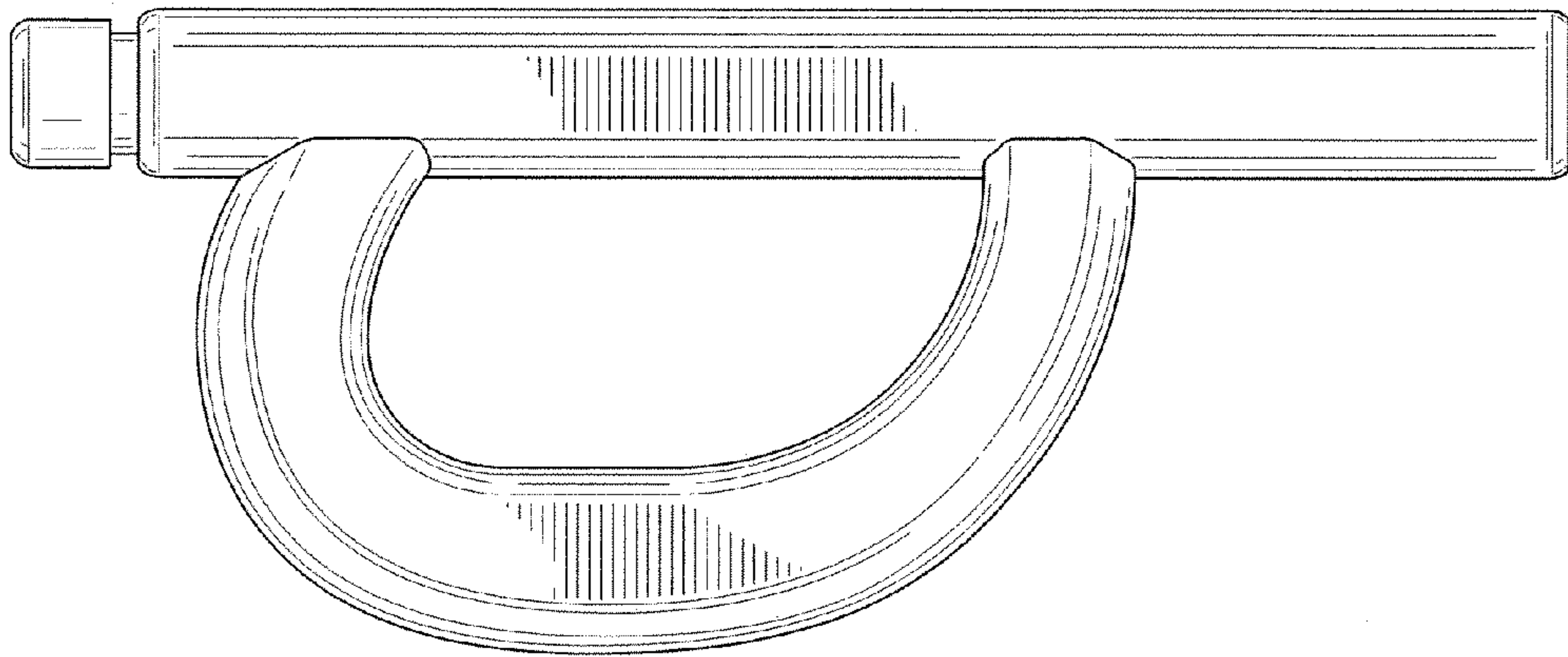

FIG. 3

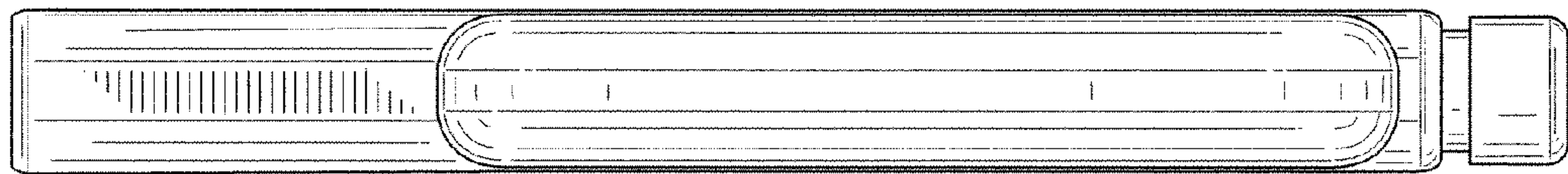

FIG. 4

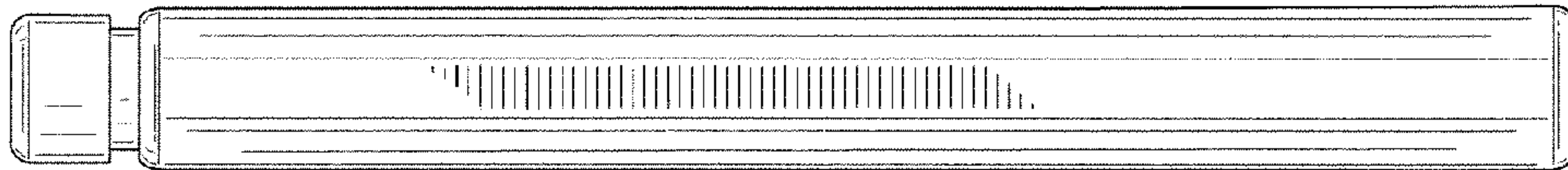

FIG. 5

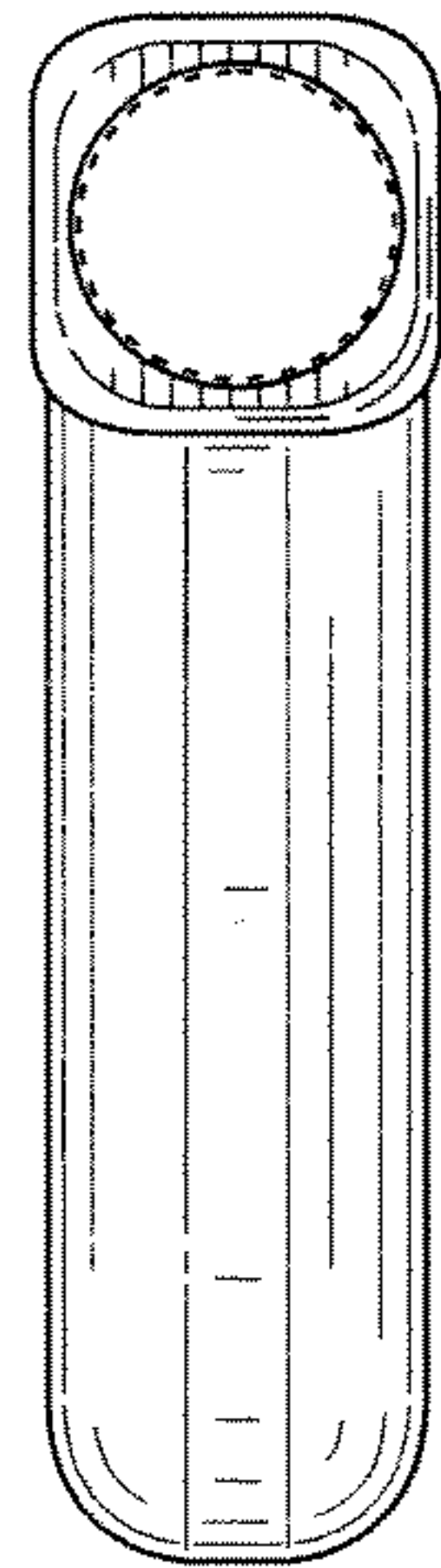

FIG. 6

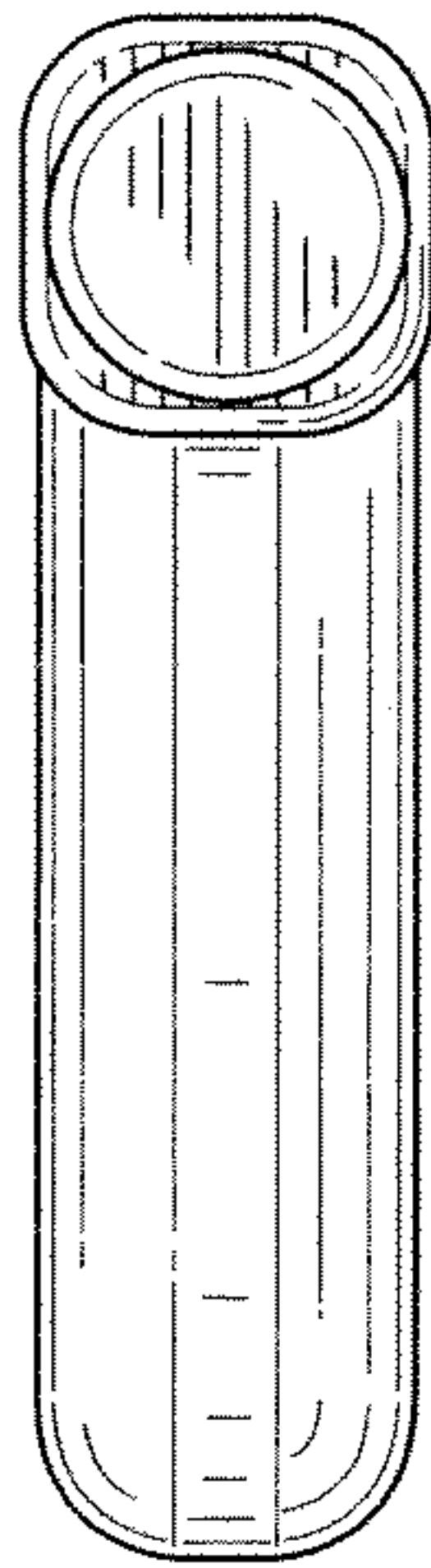

FIG. 7