



US00D682393S

(12) **United States Design Patent**  
**Bossini et al.**

(10) **Patent No.:** **US D682,393 S**

(45) **Date of Patent:** **\*\* May 14, 2013**

(54) **SHOWER**

(75) Inventors: **Nadia Bossini**, Lumezzane S.S. (IT);  
**Mitsuya Obara**, Kitakyushu (JP)

(73) Assignees: **Bossini S.p.A.**, Brescia (IT); **TOTO Ltd.**, Kitayushu (JP)

(\*\*) Term: **14 Years**

(21) Appl. No.: **29/424,167**

(22) Filed: **Jun. 8, 2012**

(30) **Foreign Application Priority Data**

Dec. 12, 2011 (IT) ..... BS2011O0040

(51) **LOC (9) Cl.** ..... **23-01**

(52) **U.S. Cl.**  
USPC ..... **D23/223**

(58) **Field of Classification Search** ..... D23/213,  
D23/223, 226, 229, 230; 239/460-462, 525-526,  
239/394

See application file for complete search history.

(56) **References Cited**

U.S. PATENT DOCUMENTS

D591,828 S \* 5/2009 Lobermeier ..... D23/223  
D610,651 S \* 2/2010 Wu et al. .... D23/223  
D629,868 S \* 12/2010 Barnard ..... D23/223

D654,984 S \* 2/2012 Schoenherr et al. .... D23/223  
D655,381 S \* 3/2012 Flowers et al. .... D23/223  
D655,384 S \* 3/2012 Schoenherr et al. .... D23/223  
D659,794 S \* 5/2012 Flowers et al. .... D23/223  
D667,928 S \* 9/2012 Cutler et al. .... D23/223  
D672,011 S \* 12/2012 Andrew et al. .... D23/223

\* cited by examiner

*Primary Examiner* — Robin V Webster

(74) *Attorney, Agent, or Firm* — Kilyk & Bowersox,  
P.L.L.C.

(57) **CLAIM**

The ornamental design for a shower, as shown and described.

**DESCRIPTION**

FIG. 1 is a bottom front perspective view of a shower, showing our new design;  
FIG. 2 is the top front perspective view thereof;  
FIG. 3 is the left side view thereof with the right side view being a mirror image thereof;  
FIG. 4 is the front view thereof;  
FIG. 5 is the rear view thereof;  
FIG. 6 is the top view thereof; and,  
FIG. 7 is the bottom view thereof.

The broken line showing is included for the purpose of illustrating and forms no part of the claimed design.

**1 Claim, 7 Drawing Sheets**

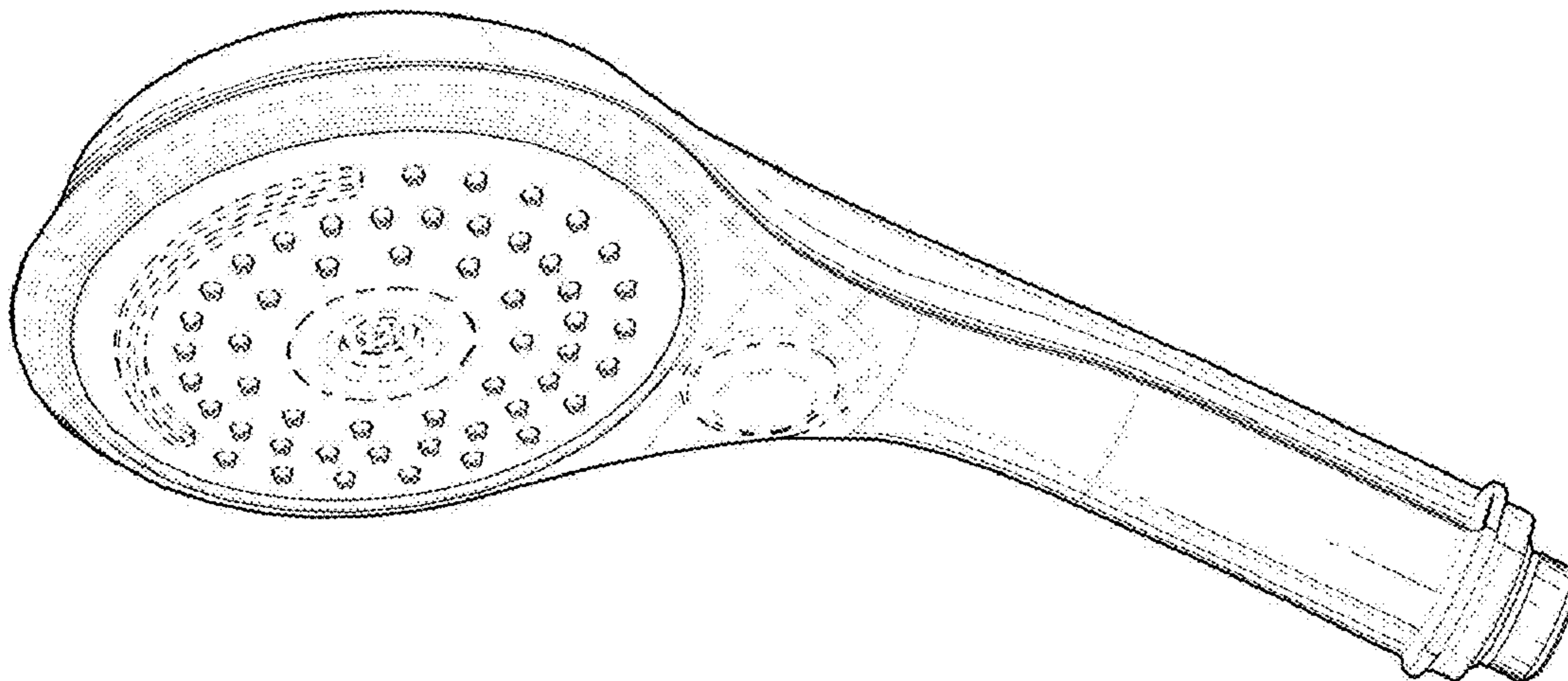

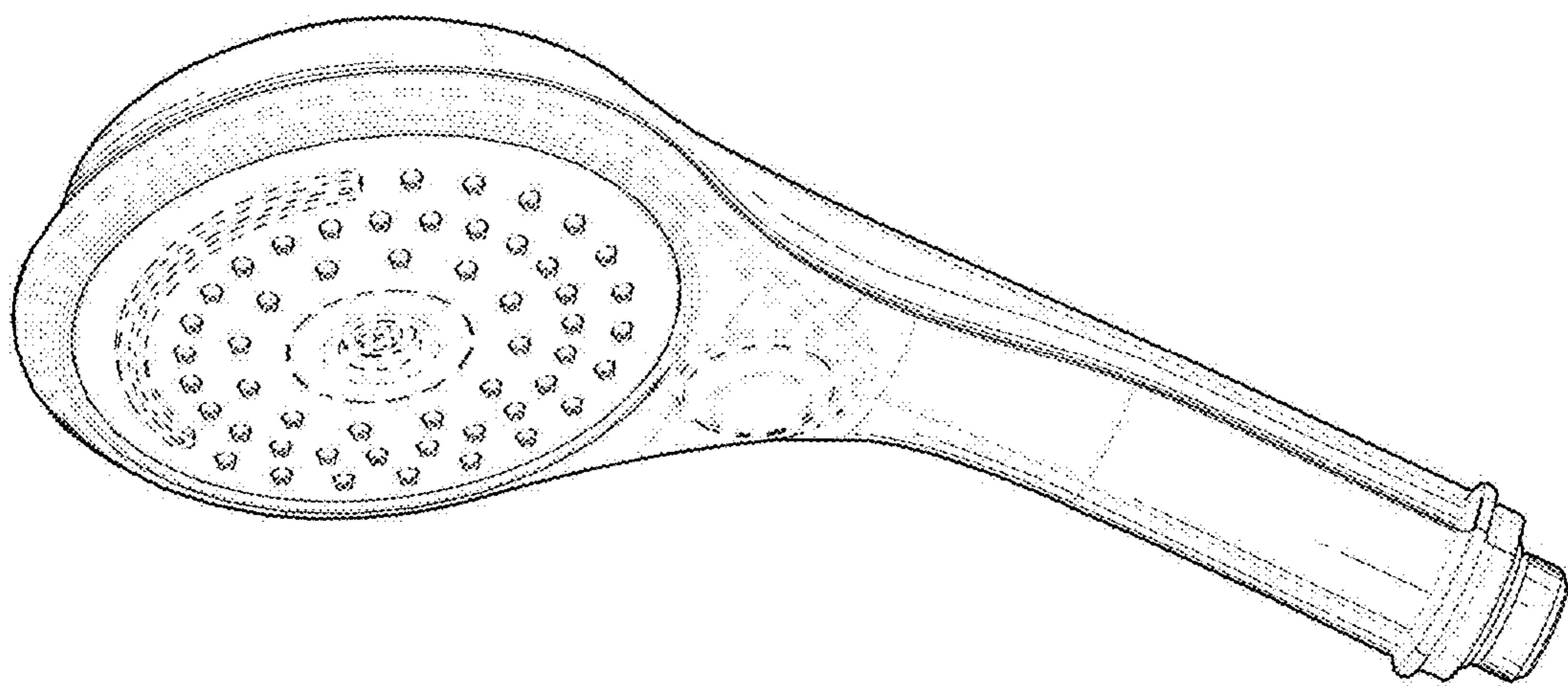

Fig. 1

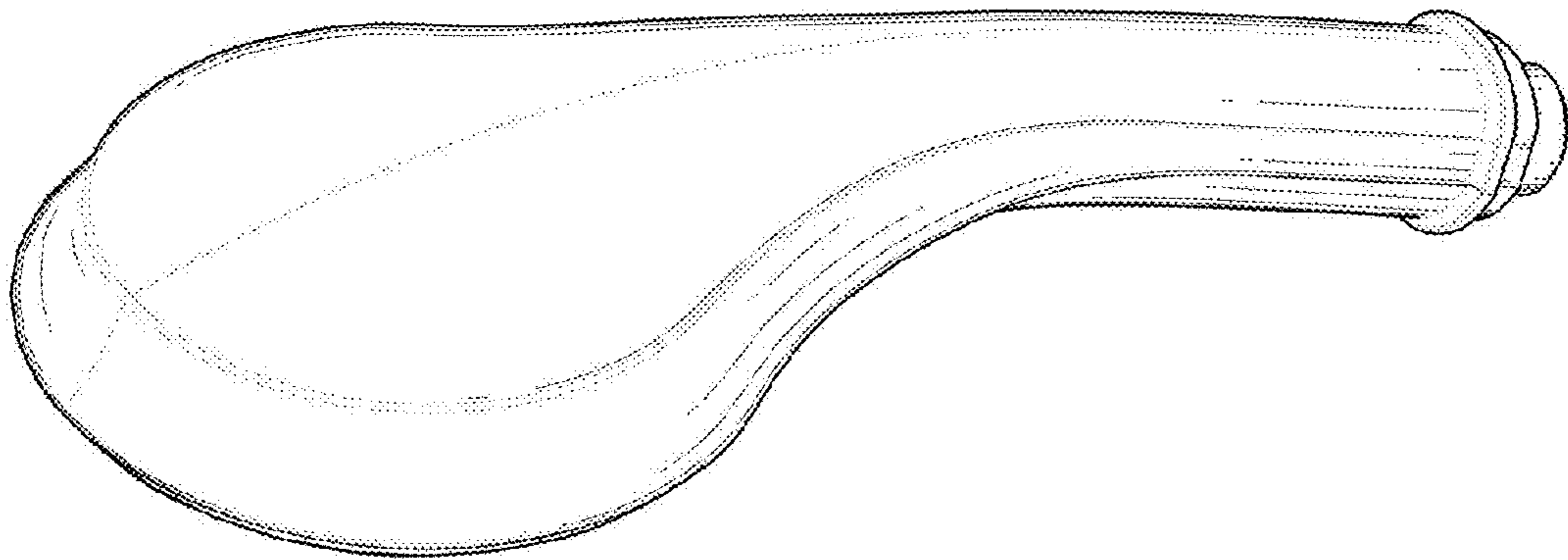

Fig. 2

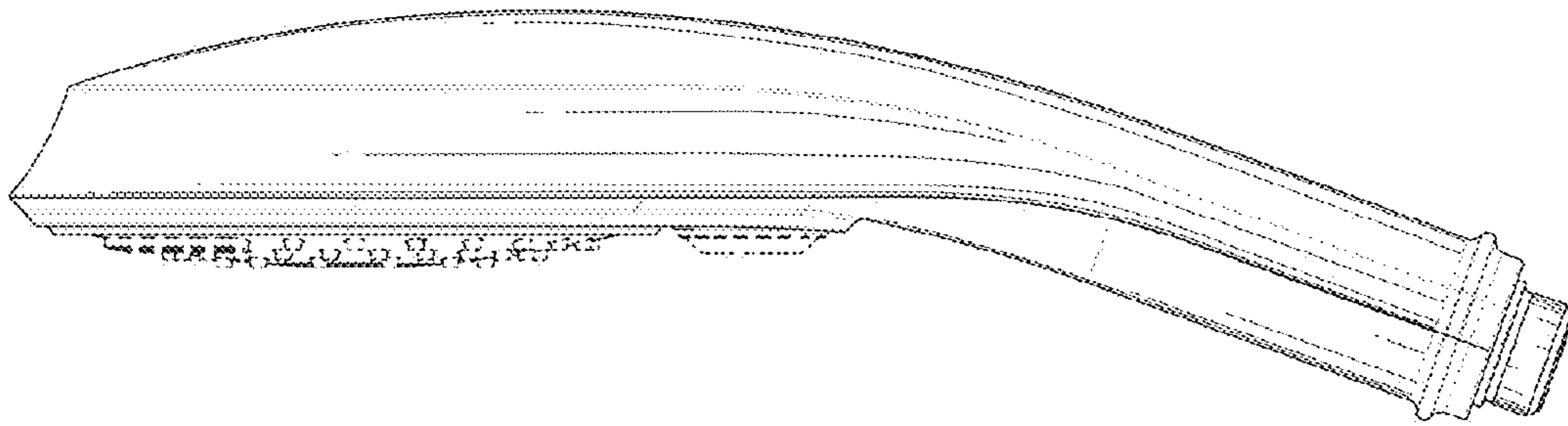

Fig. 3

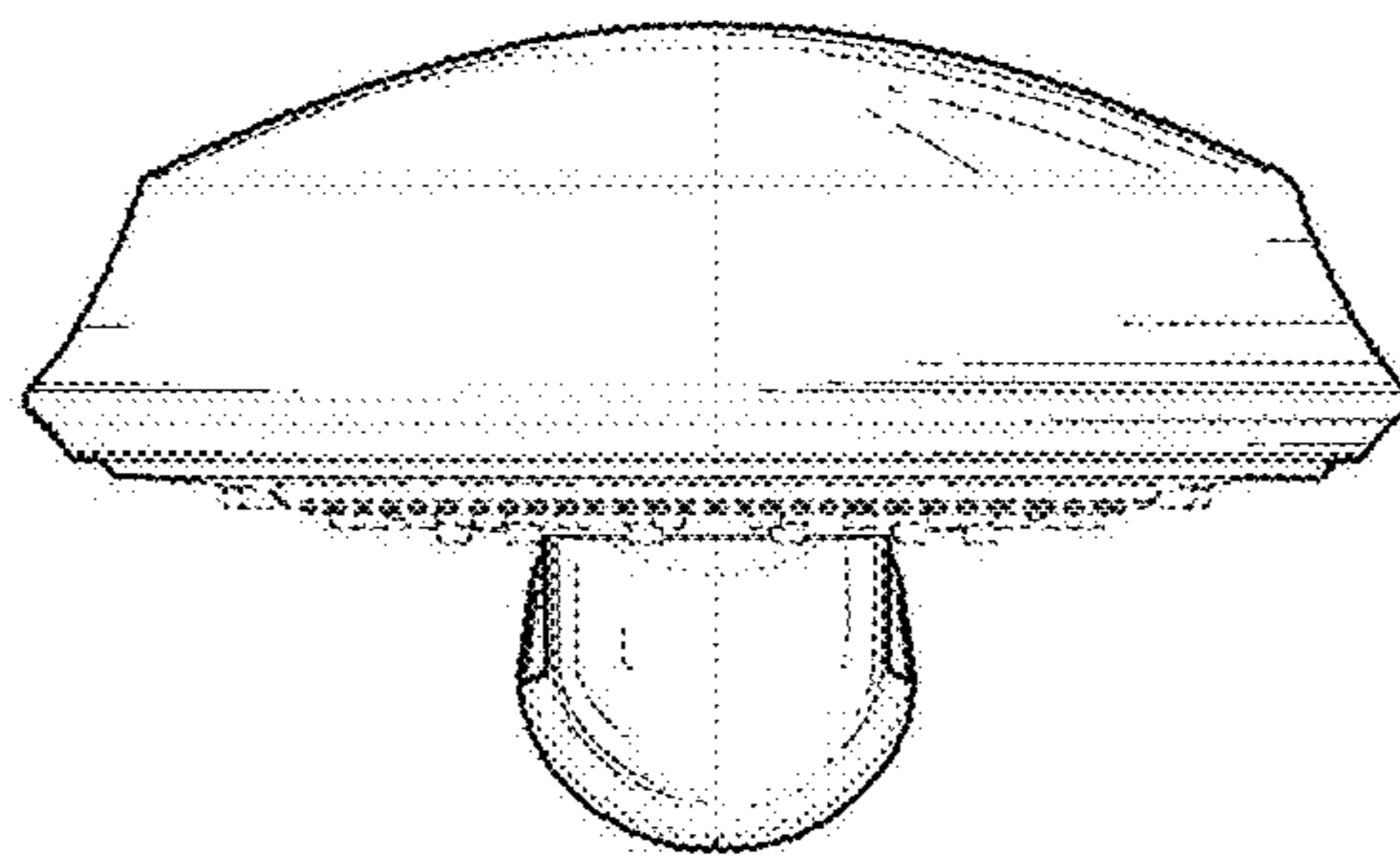

Fig. 4

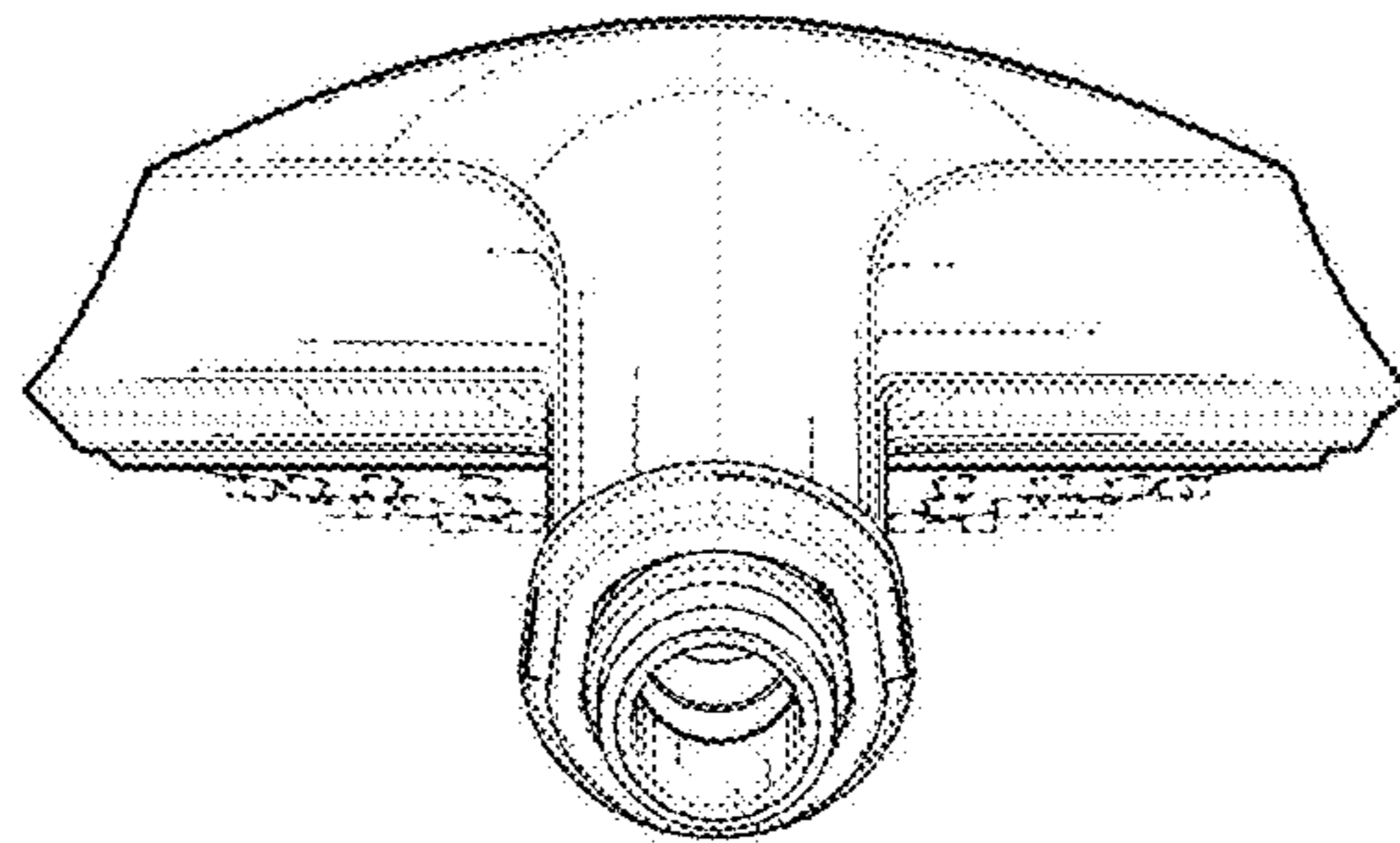

Fig. 5

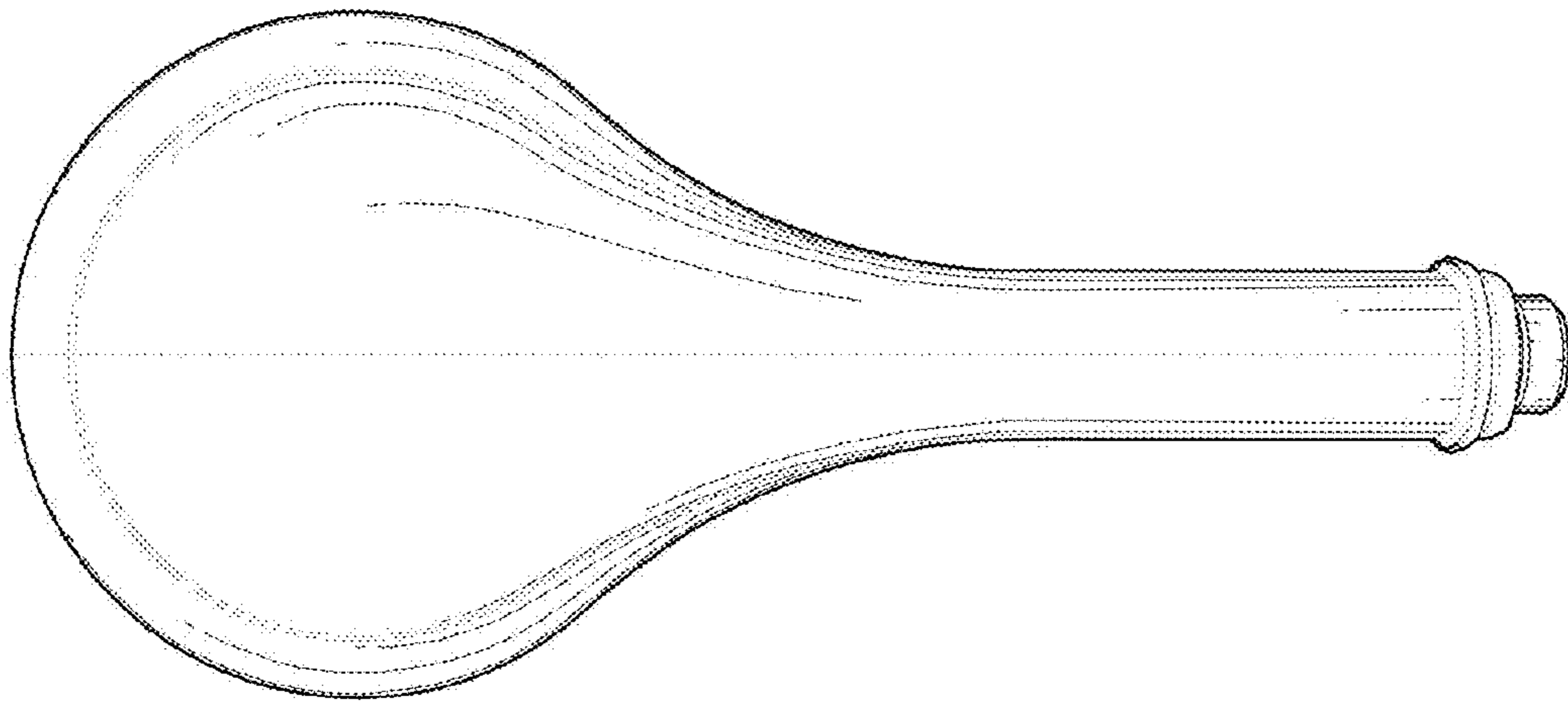

Fig. 6

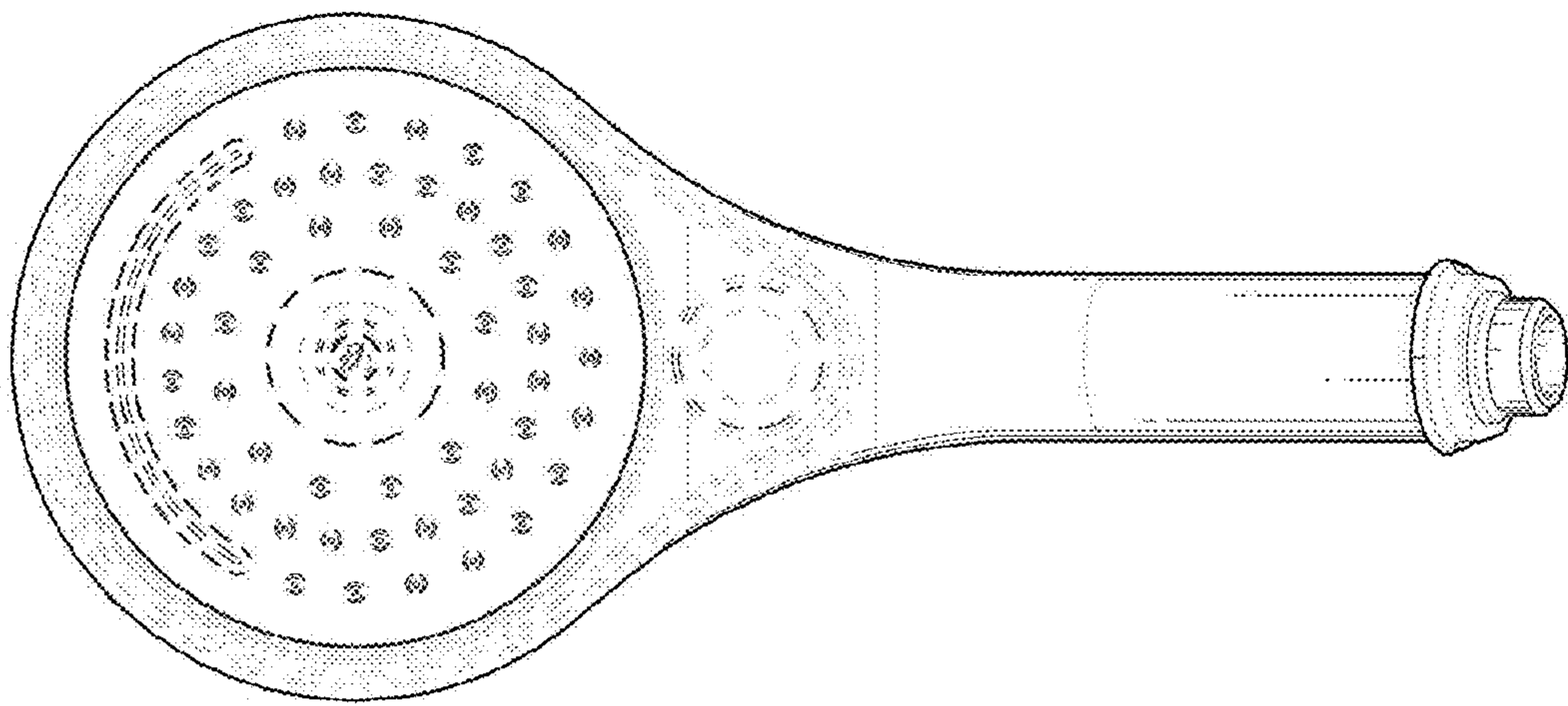

Fig. 7