



US00D682373S

(12) **United States Design Patent**
Garnuette

(10) **Patent No.:** **US D682,373 S**

(45) **Date of Patent:** **** May 14, 2013**

(54) **SHOE WEIGHT**

(76) **Inventor:** **Shawn Garnuette**, Pfafftown, NC (US)

(**) **Term:** **14 Years**

(21) **Appl. No.:** **29/424,767**

(22) **Filed:** **Jun. 15, 2012**

(51) **LOC (9) Cl.** **21-02**

(52) **U.S. Cl.**
USPC **D21/683**

(58) **Field of Classification Search** D21/662,
D21/680, 683, 685, 694; 482/55, 79, 92-94,
482/97-105, 124; 36/2.6, 128, 132, 136;
D2/905, 946; 2/19

See application file for complete search history.

D382,691	S	*	8/1997	Fuller et al.	D2/946
D471,606	S	*	3/2003	Strother	D21/683
D488,523	S	*	4/2004	Hamlin	D21/683
7,000,337	B2	*	2/2006	Harrington	36/132
7,063,650	B1	*	6/2006	Beausoleil	482/105
7,833,137	B2	*	11/2010	Garnuette	482/79
D637,665	S	*	5/2011	Walsh	D21/683
D662,557	S	*	6/2012	Nawracaj	D21/683
D667,630	S	*	9/2012	Christ	D3/215
D670,074	S	*	11/2012	Willows et al.	D2/946
2005/0227829	A1	*	10/2005	Smith	482/105
2011/0009713	A1	*	1/2011	Feinberg	600/301

* cited by examiner

Primary Examiner — Susan E Krakower

(74) *Attorney, Agent, or Firm* — Dale J. Ream

(57) **CLAIM**

The ornamental design for a shoe weight, as shown and described.

(56) **References Cited**

U.S. PATENT DOCUMENTS

D200,415	S	*	2/1965	Tarbox	D21/683
D218,621	S	*	9/1970	Scott, Jr.	D21/683
3,582,067	A	*	6/1971	Rucks	280/816
D254,984	S	*	5/1980	Goyette, Jr.	D21/791
4,322,072	A	*	3/1982	White	482/105
4,371,983	A	*	2/1983	Piotti, Jr.	2/19
4,455,764	A	*	6/1984	Rock et al.	36/136
4,507,882	A	*	4/1985	Harrell	36/136
D289,785	S	*	5/1987	Lindsey	D21/683
4,841,646	A	*	6/1989	Maurer, Jr.	36/2.6
4,940,066	A	*	7/1990	Santilli et al.	128/882
5,042,119	A	*	8/1991	Williams	24/712.3
D336,971	S	*	7/1993	Flisek	D2/905
5,632,709	A	*	5/1997	Walsh	482/105

DESCRIPTION

FIG. 1 is a perspective view of a shoe weight showing my new design in use with a shoe;
FIG. 2 is a perspective view thereof;
FIG. 3 is a front view thereof;
FIG. 4 is a back view thereof;
FIG. 5 is a left side view thereof;
FIG. 6 is a right side view thereof;
FIG. 7 is a top view thereof; and,
FIG. 8 is a bottom view thereof.

In the drawings, the broken lines showing a shoe illustrate environment and form no part of the claimed design.

1 Claim, 4 Drawing Sheets

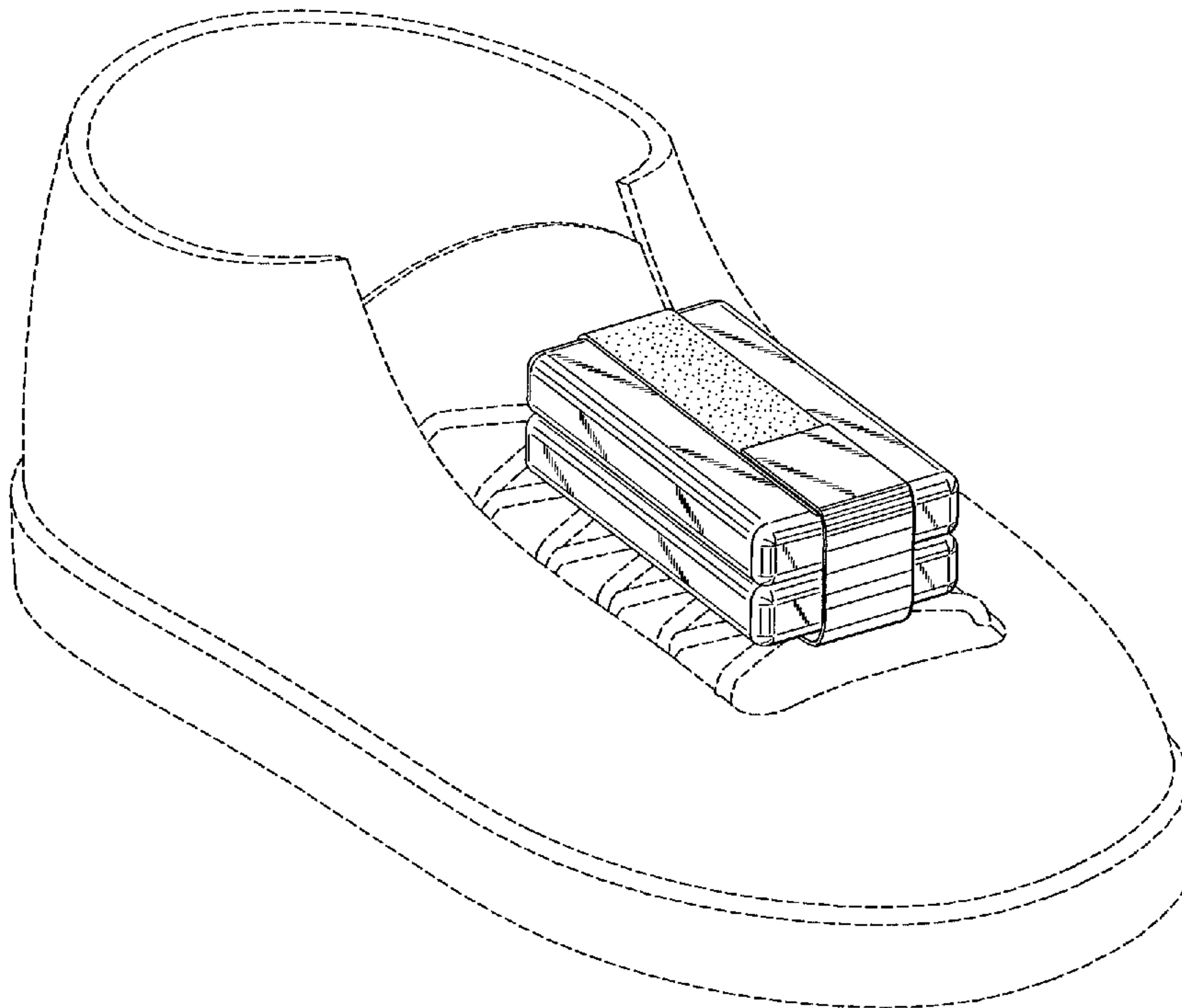

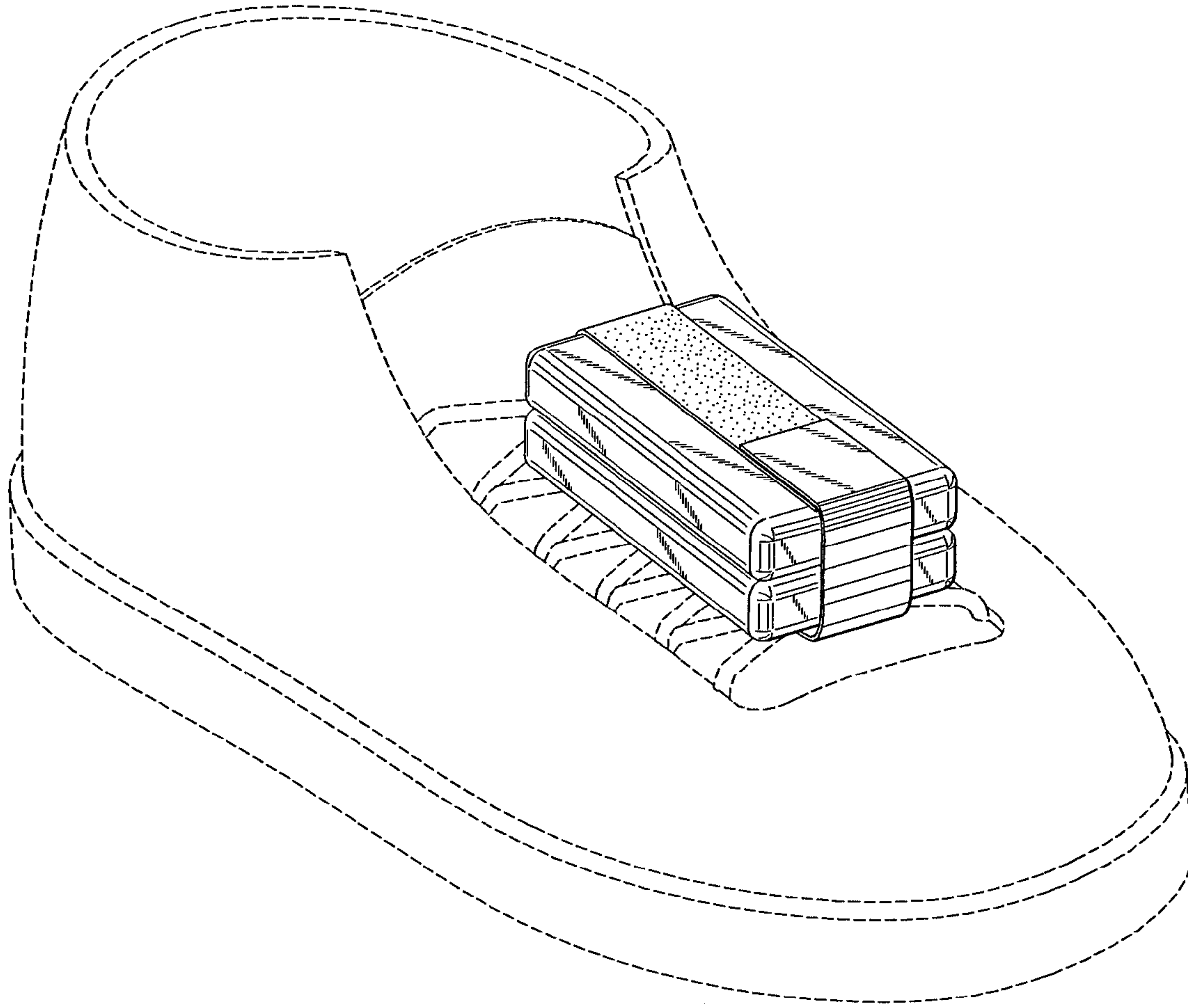

Fig. 1

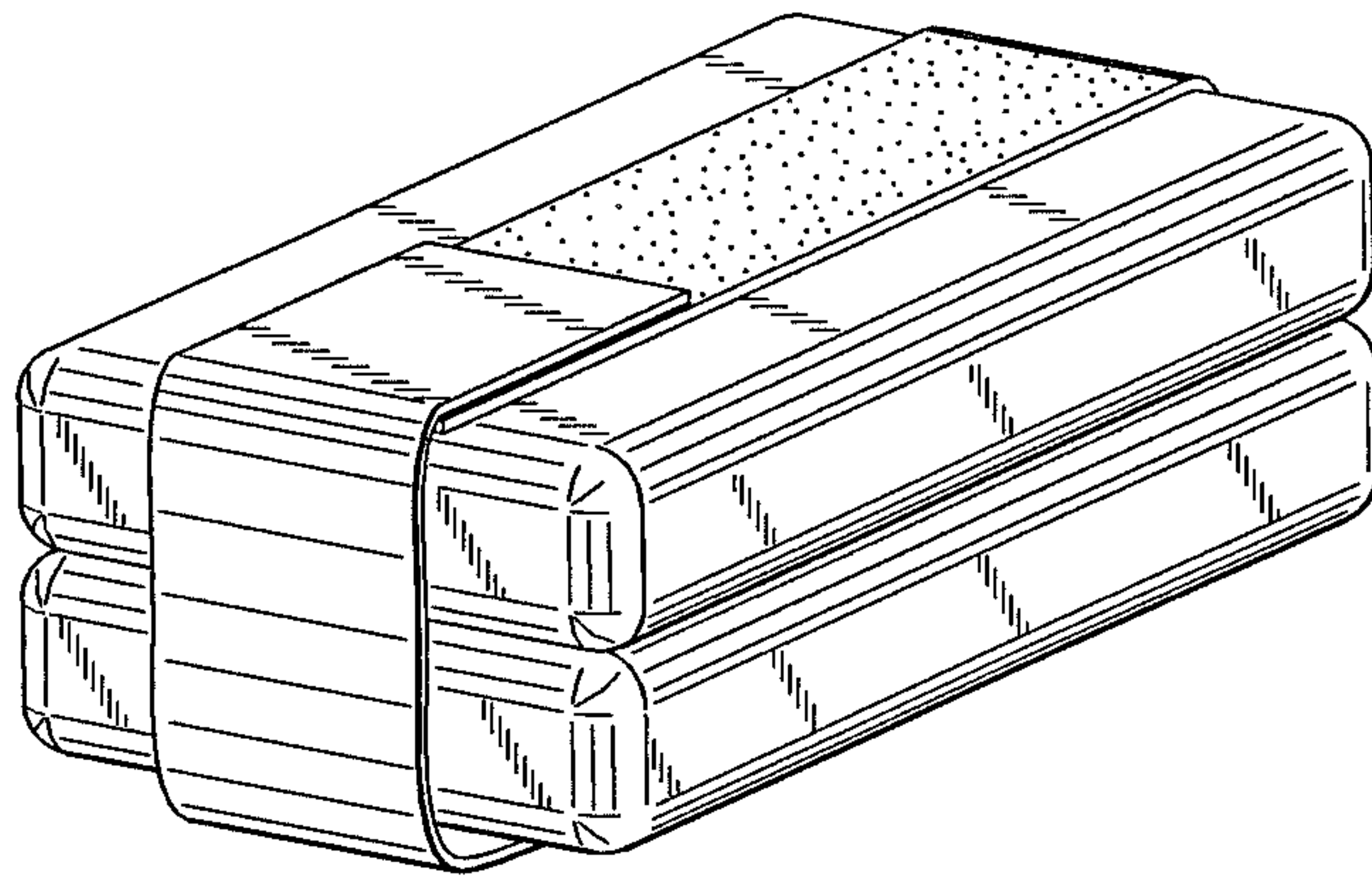

Fig. 2

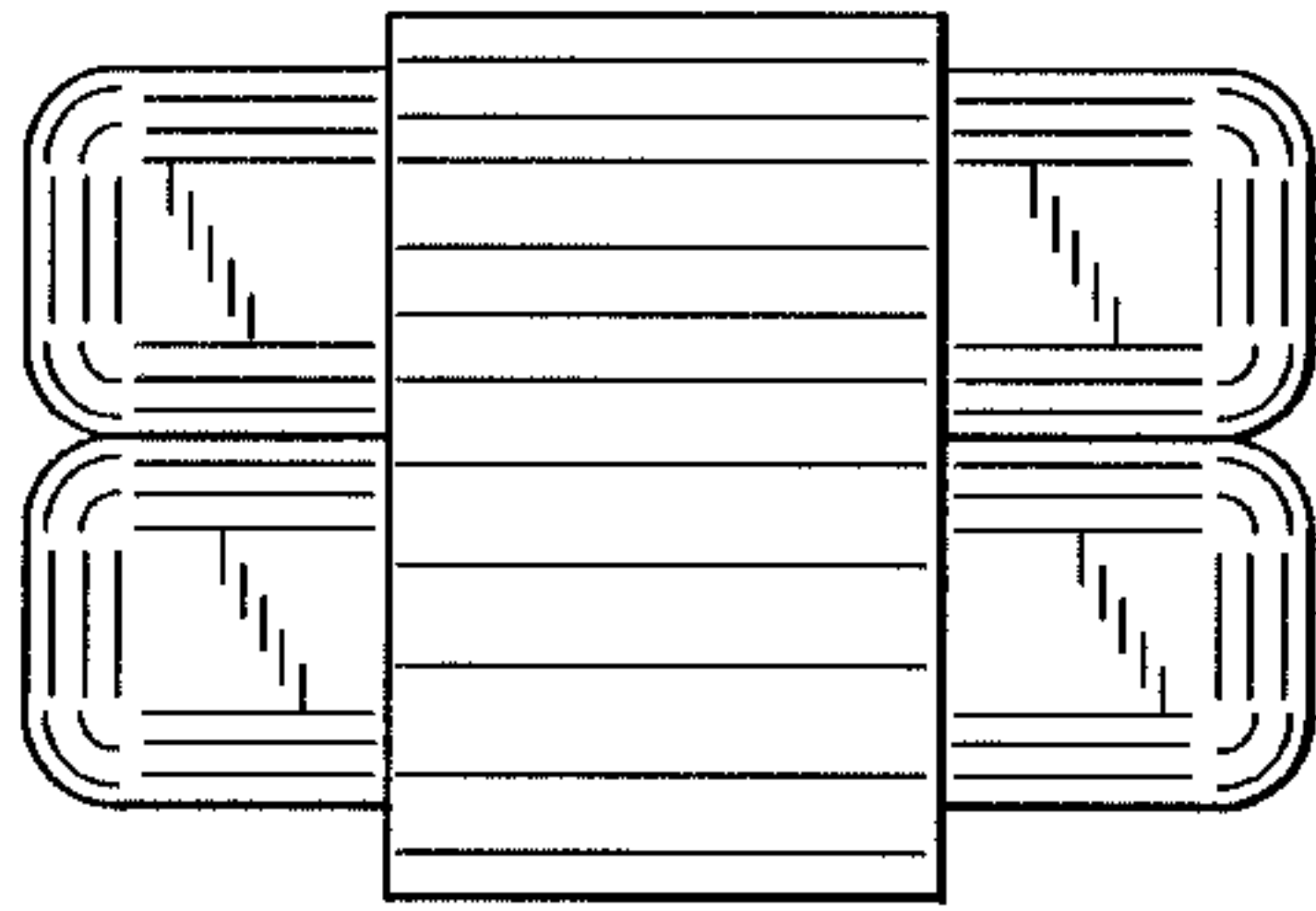

Fig. 3

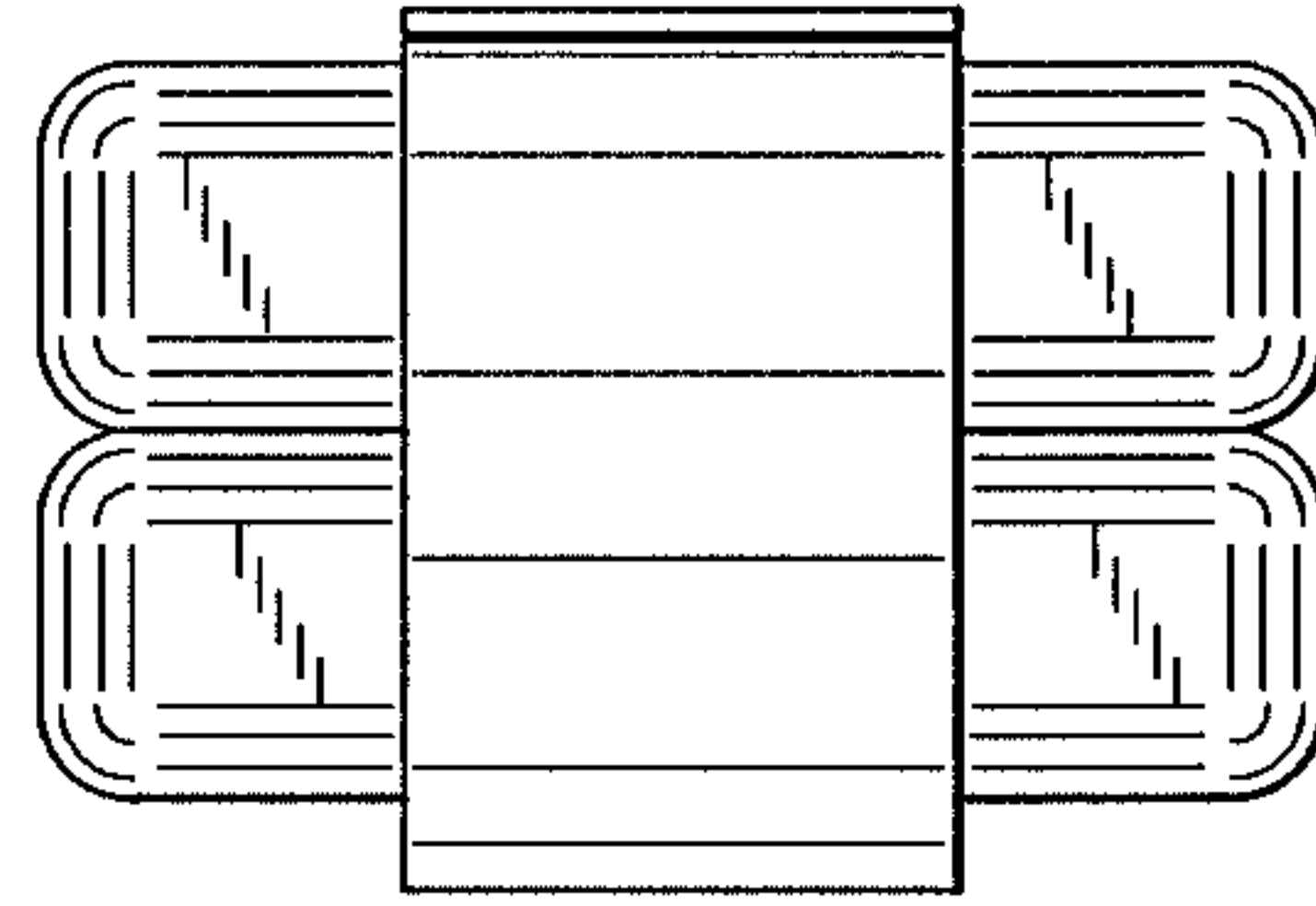

Fig. 4

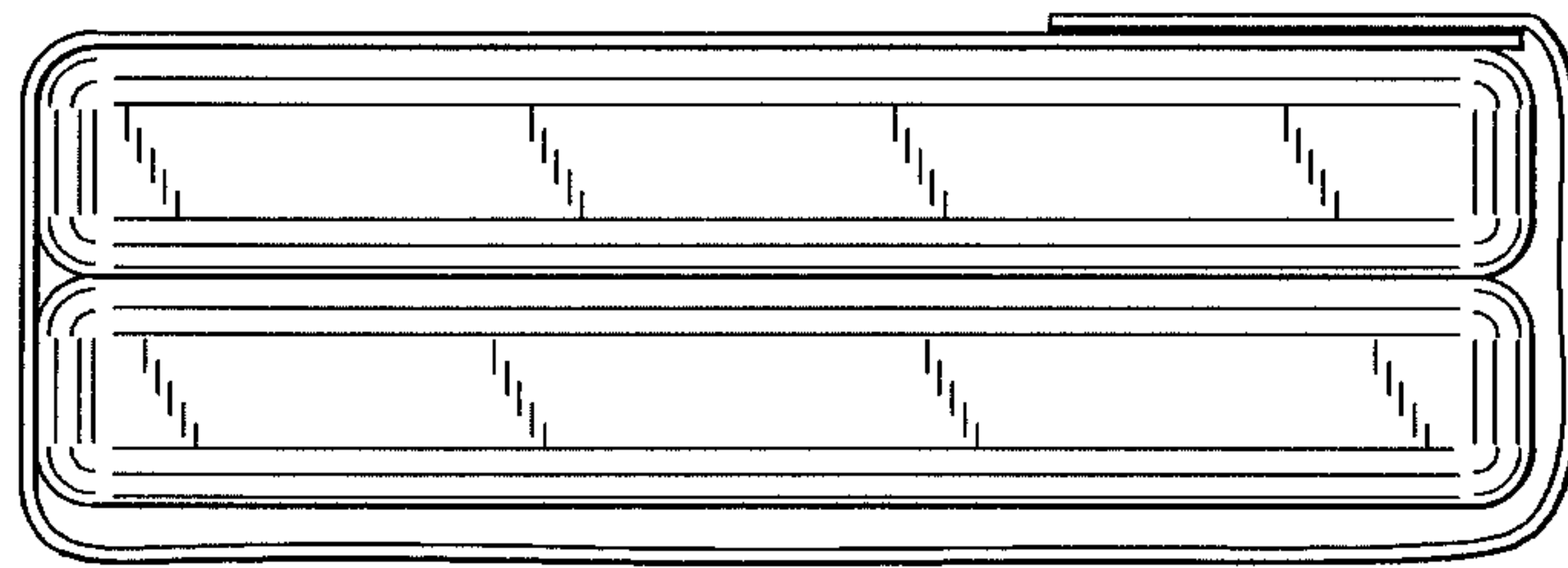

Fig. 5

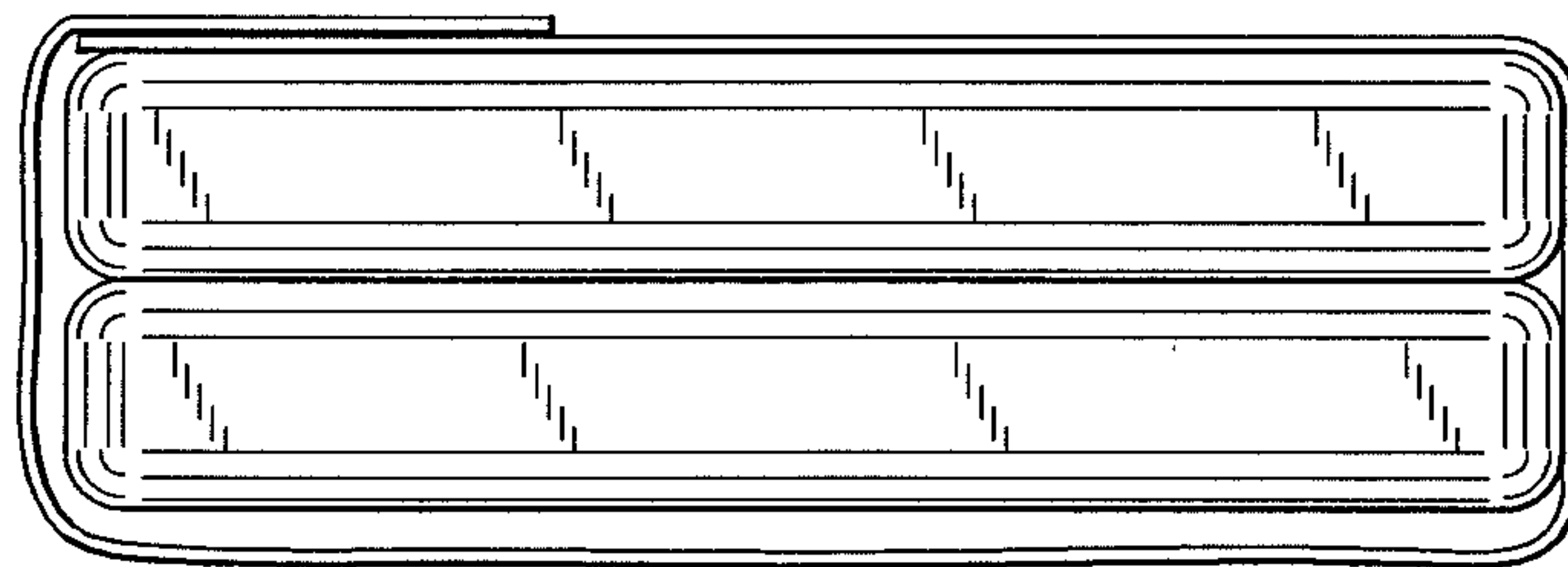

Fig. 6

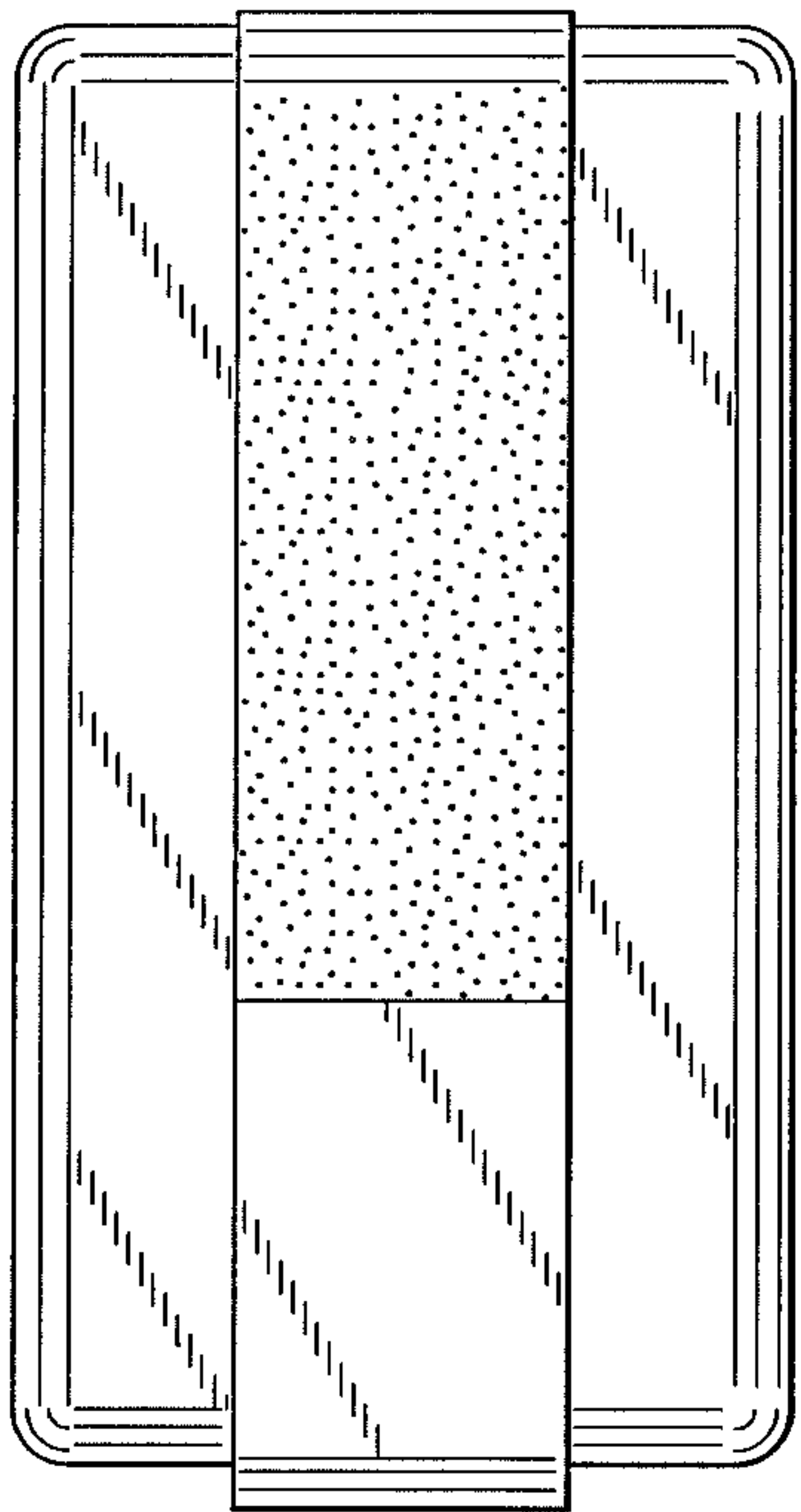

Fig. 7

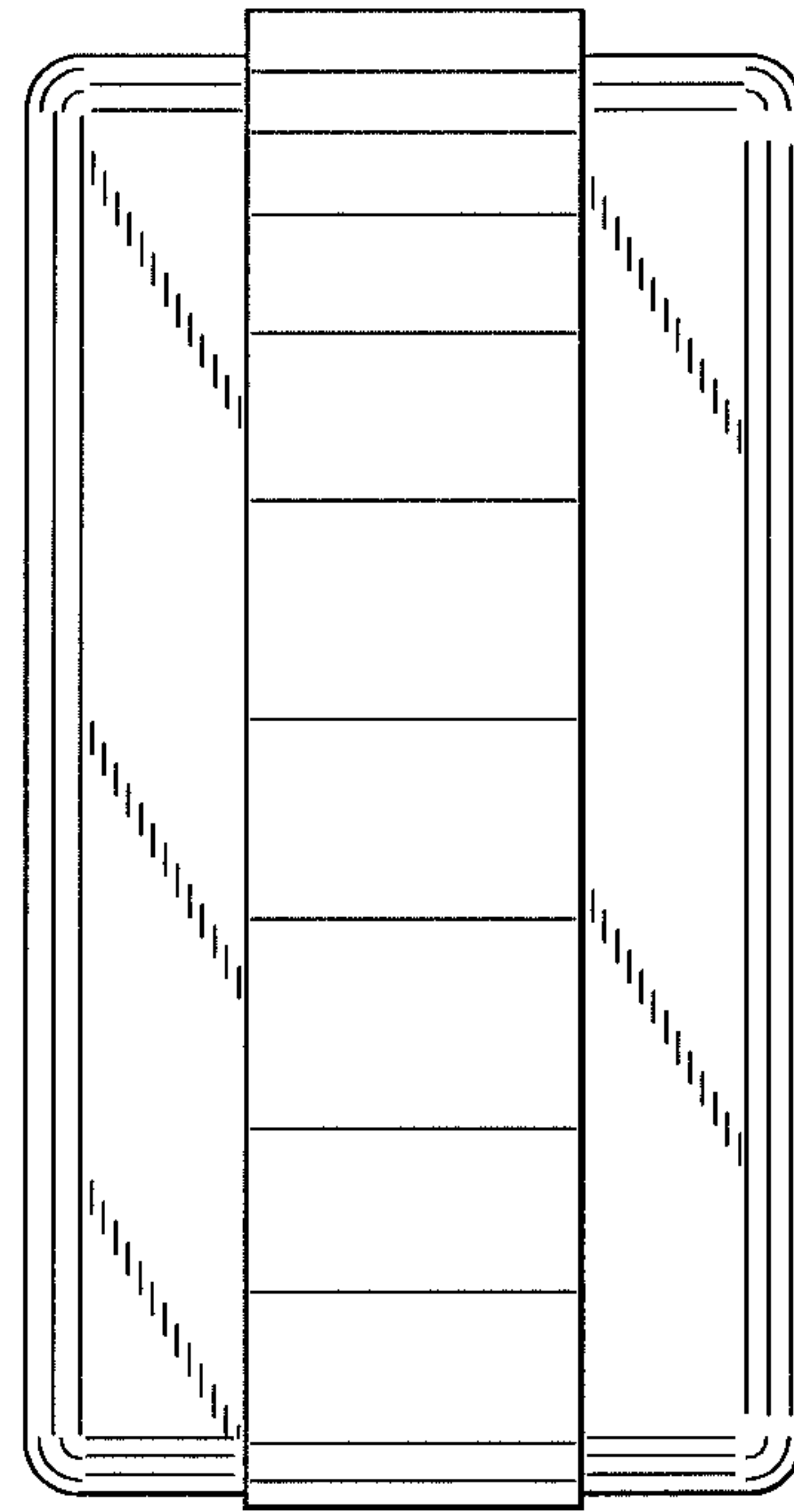

Fig. 8