



US00D682339S

(12) **United States Design Patent**
Uppiano et al.

(10) **Patent No.:** **US D682,339 S**
(45) **Date of Patent:** **** May 14, 2013**

(54) **GAME CAMERA**

(75) Inventors: **Eric R. Uppiano**, Beaverton, OR (US);
David D. Lewin, Portland, OR (US)

(73) Assignee: **Leupold & Stevens, Inc.**, Beaverton,
OR (US)

(**) Term: **14 Years**

(21) Appl. No.: **29/405,318**

(22) Filed: **Nov. 1, 2011**

(51) **LOC (9) Cl.** **16-01**

(52) **U.S. Cl.**
USPC **D16/218**

(58) **Field of Classification Search** D16/200–204,
D16/218; 348/143, 373–376; 396/427, 535–541
See application file for complete search history.

(56) **References Cited**

U.S. PATENT DOCUMENTS

6,449,431	B1 *	9/2002	Cuddeback et al.	396/427
6,834,162	B1	12/2004	Schnell		
D518,843	S *	4/2006	Tullberg et al.	D16/218
7,534,056	B2	5/2009	Cross et al.		

D616,009	S *	5/2010	Schnell	D16/218
D628,224	S *	11/2010	Barley et al.	D16/203
D630,236	S *	1/2011	Lian	D16/203
D655,736	S *	3/2012	Barley et al.	D16/203
2002/0159770	A1	10/2002	Moultrie		
2008/0151055	A1	6/2008	Elsemore		
2009/0237509	A1	9/2009	Saxon		

* cited by examiner

Primary Examiner — Adir Aronovich

(74) *Attorney, Agent, or Firm* — Stoel Rives LLP

(57) **CLAIM**

The ornamental design for a game camera, as shown and described.

DESCRIPTION

FIG. 1 is a front, top and left side perspective view of a game camera showing our new design;
FIG. 2 is a front elevational view thereof;
FIG. 3 is a rear elevational view thereof;
FIG. 4 is a right side elevational view thereof;
FIG. 5 is a left side elevational view thereof;
FIG. 6 is a top plan view thereof; and,
FIG. 7 is a bottom plan view thereof.

1 Claim, 5 Drawing Sheets

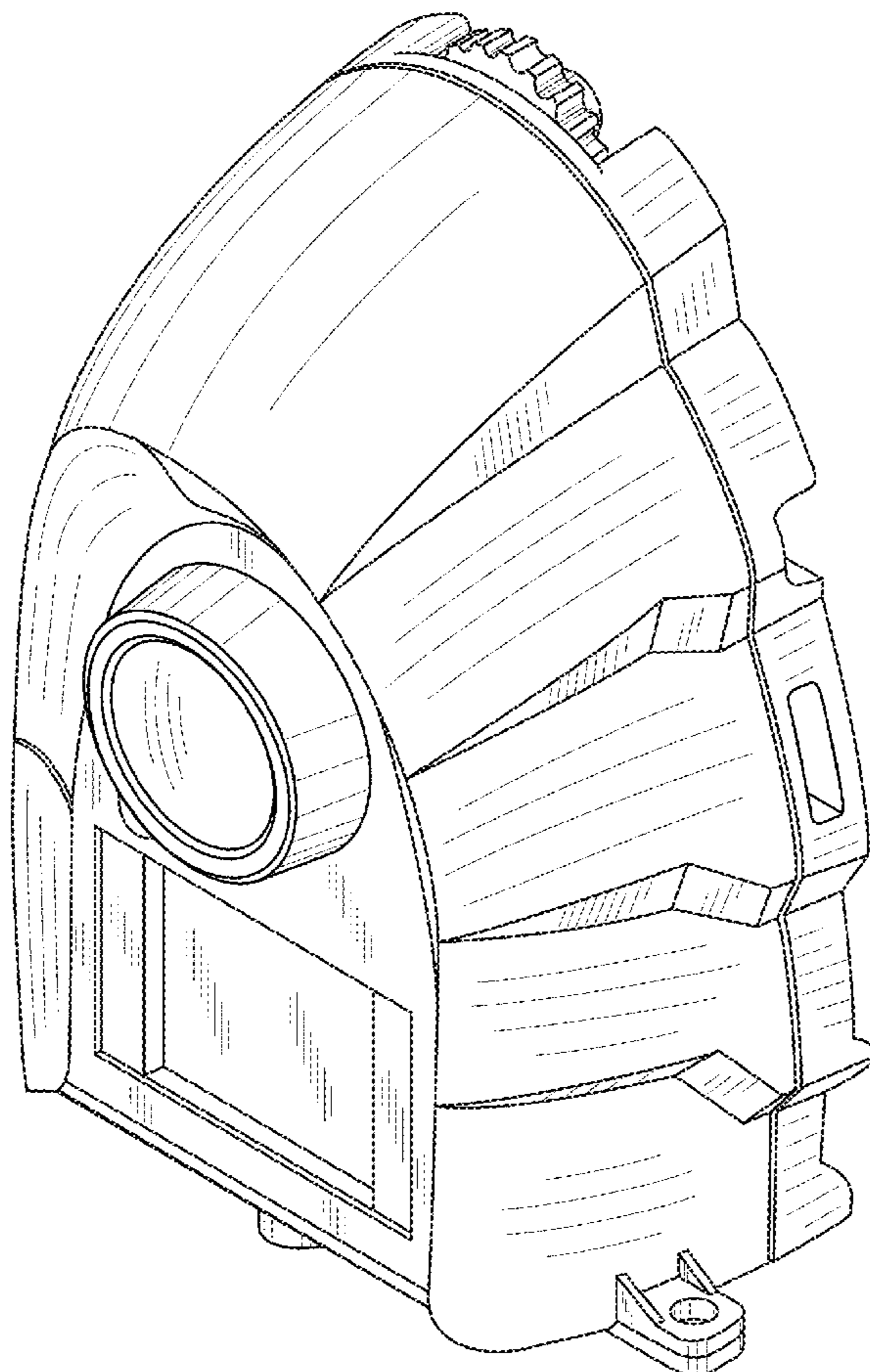

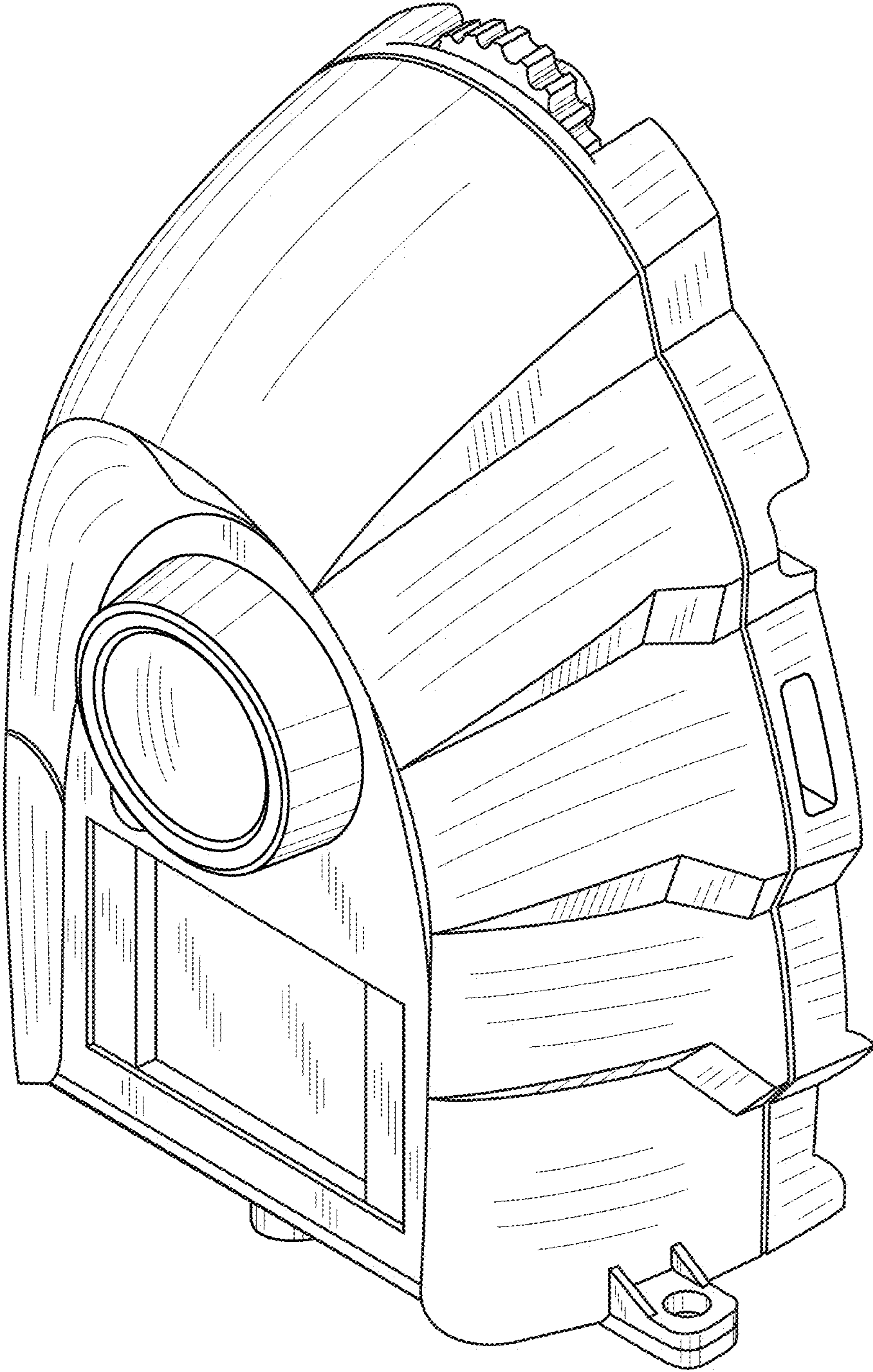

FIG. 1

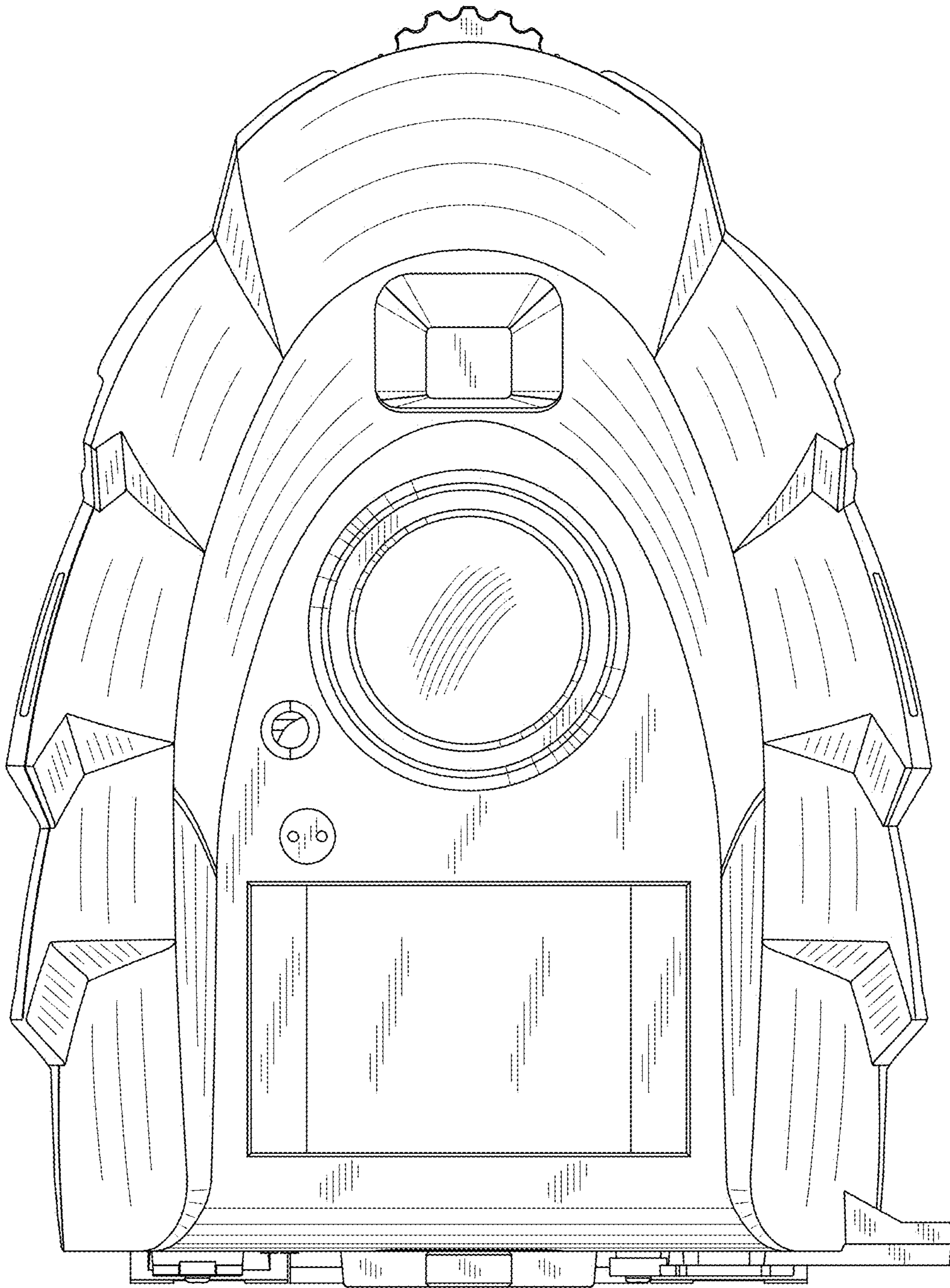

FIG. 2

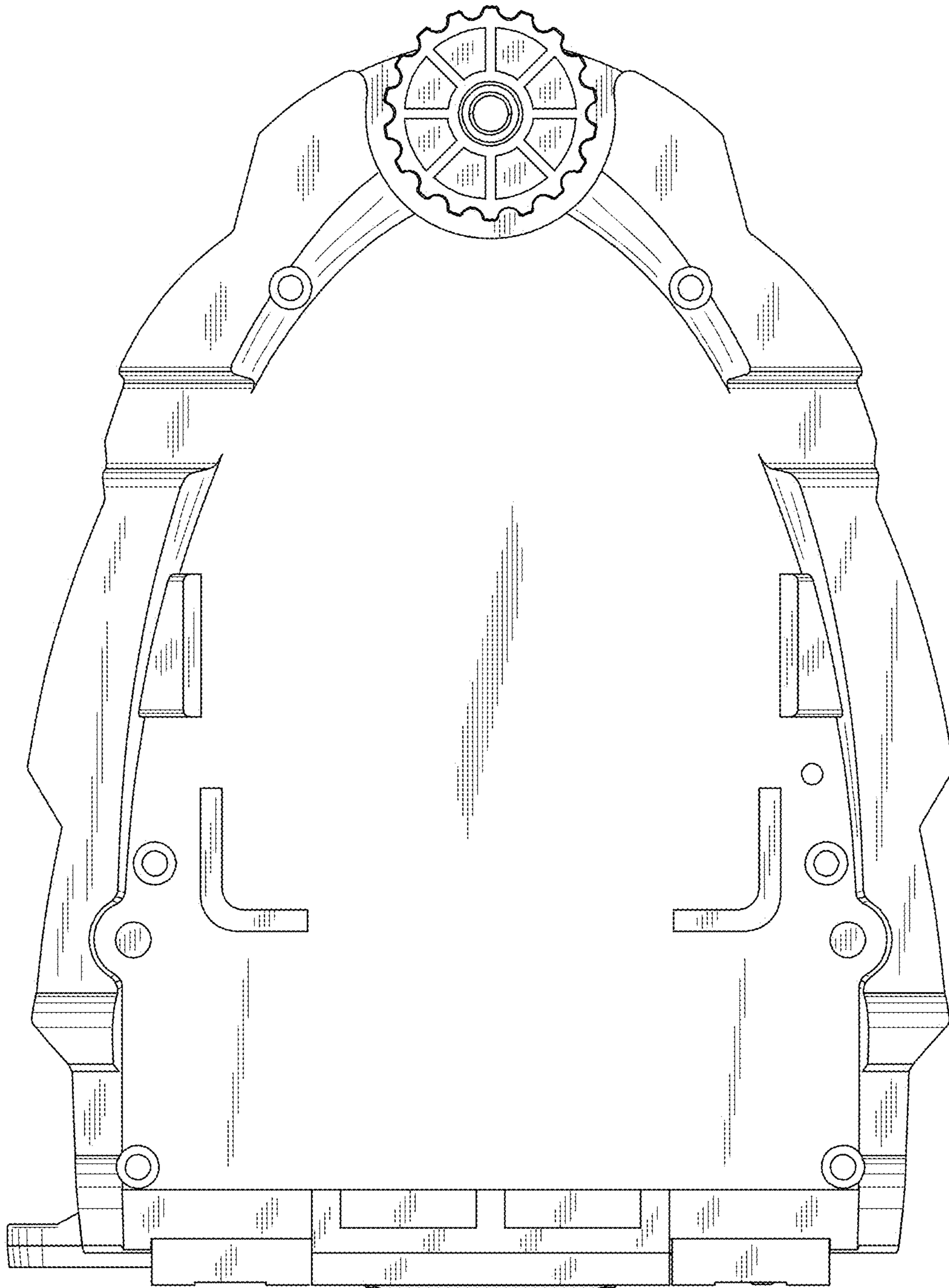

FIG. 3

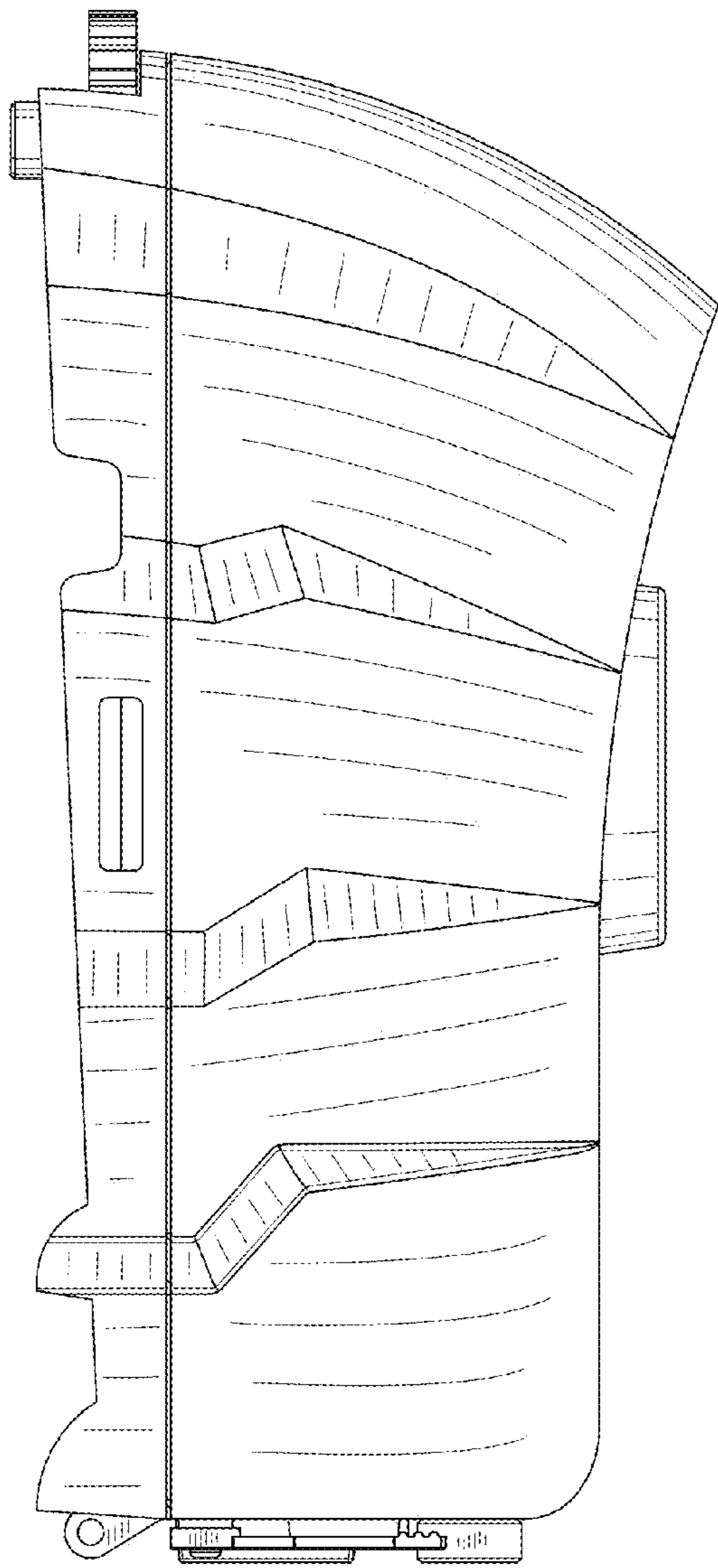

FIG. 4

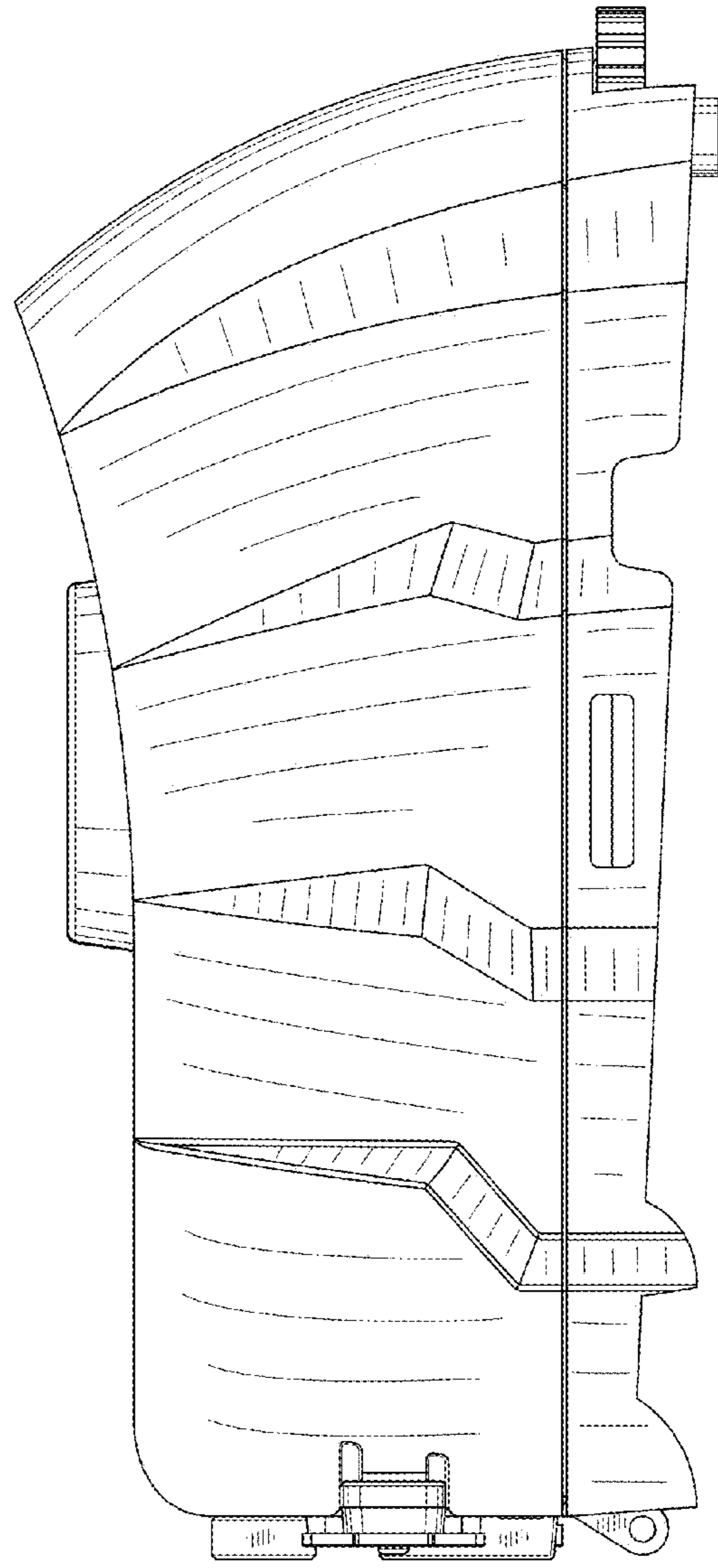

FIG. 5

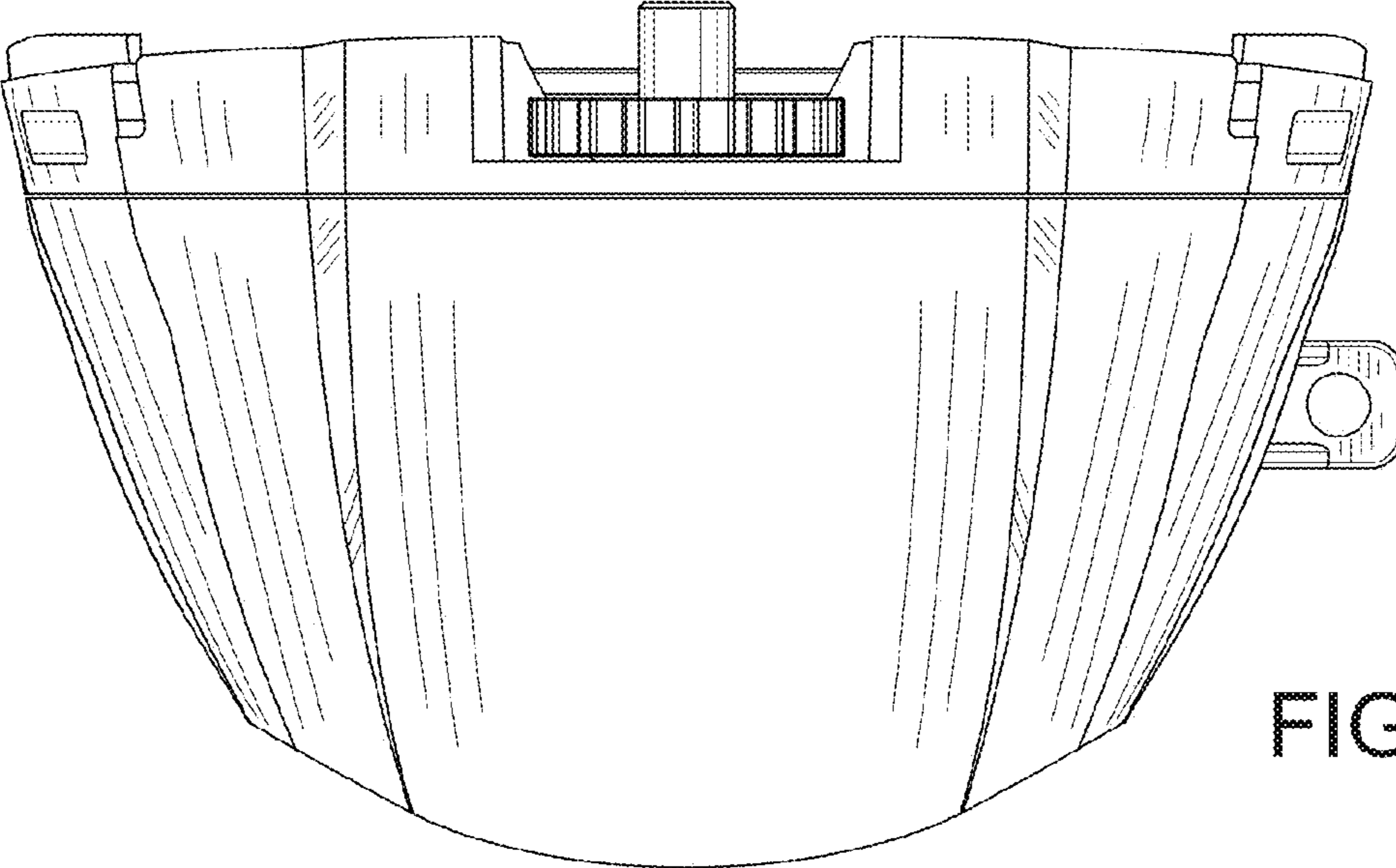

FIG. 6

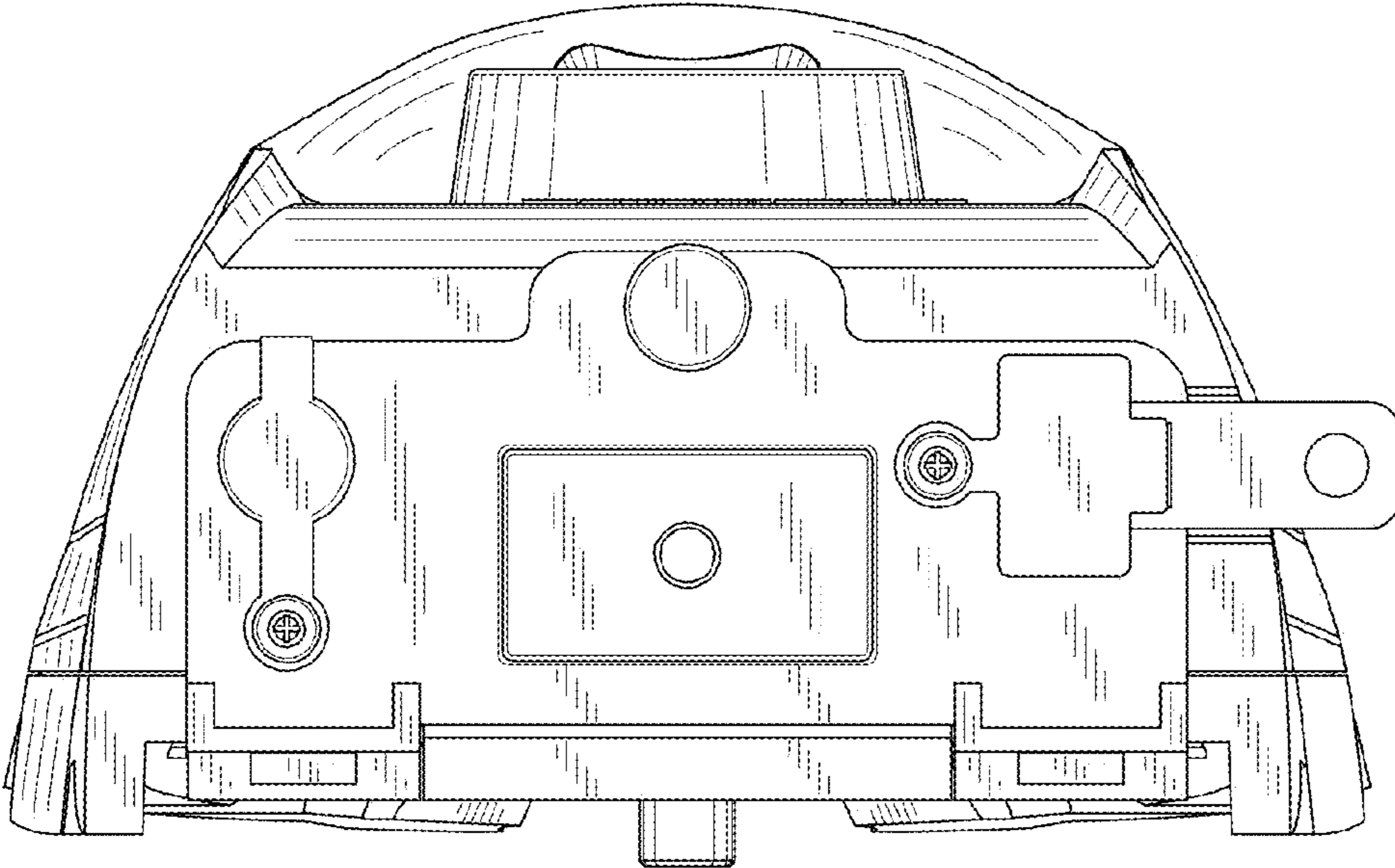

FIG. 7