



US00D682276S

(12) **United States Design Patent**  
**Nakata**

(10) **Patent No.:** **US D682,276 S**

(45) **Date of Patent:** **\*\* May 14, 2013**

(54) **STRETCHABLE STYLUS PEN**

(71) Applicant: **Wacom Co., Ltd.**, Kazo (JP)

(72) Inventor: **Takaaki Nakata**, Kuki (JP)

(73) Assignee: **Wacom Co., Ltd.**, Kazo-shi (JP)

(\*\*) Term: **14 Years**

(21) Appl. No.: **29/439,890**

(22) Filed: **Dec. 17, 2012**

(30) **Foreign Application Priority Data**

Jun. 18, 2012 (JP) ..... 2012-014433

(51) **LOC (9) Cl.** ..... **14-02**

(52) **U.S. Cl.**  
USPC ..... **D14/411**

(58) **Field of Classification Search** ..... D8/61;  
D14/411; D19/35, 36, 41-51, 54-58; 401/55,  
401/99, 100, 104-107, 196, 197, 202, 208,  
401/209, 213, 192, 195, 243; 708/107; 345/179,  
345/173; 178/19.01; 700/94  
See application file for complete search history.

(56) **References Cited**

**U.S. PATENT DOCUMENTS**

- D364,424 S \* 11/1995 Shimizu ..... D19/51
- D395,875 S \* 7/1998 Aiken et al. .... D14/411
- D415,197 S \* 10/1999 Izushima ..... D19/48
- D418,163 S \* 12/1999 Rosen ..... D19/51
- D456,411 S \* 4/2002 Kourushi ..... D14/411
- D497,387 S \* 10/2004 Cetera ..... D19/36
- D538,854 S \* 3/2007 Nakazawa ..... D19/51
- D595,352 S \* 6/2009 Ikeda ..... D19/48

(Continued)

**FOREIGN PATENT DOCUMENTS**

- JP D1073390 S 6/2000
- JP D1073432 S 6/2000

*Primary Examiner* — Austin Murphy

(74) *Attorney, Agent, or Firm* — Christensen O'Connor Johnson Kindness PLLC

(57) **CLAIM**

The ornamental design for a stretchable stylus pen, as shown and described.

**DESCRIPTION**

FIG. 1 is a right side elevation view of a stretchable stylus pen showing my new design, wherein the stretchable stylus pen is shown in an extended position, and wherein the left side elevation view of the stretchable stylus pen is a mirror image of the right side elevation view;

FIG. 2 is a bottom plan view thereof;

FIG. 3 is a top plan view thereof;

FIG. 4 is a front elevation view thereof;

FIG. 5 is a rear elevation view thereof;

FIG. 6 is a front bottom right isometric view thereof;

FIG. 7 is a front bottom right isometric view thereof, with the stretchable stylus pen shown in a retracted position;

FIG. 8 is a right side elevation view of an alternative embodiment of the stretchable stylus pen shown in FIG. 1, wherein the stretchable stylus pen is shown in an extended position, and wherein the left side elevation view of the stretchable stylus pen is a mirror image of the right side elevation view;

FIG. 9 is a bottom plan view thereof;

FIG. 10 is a top plan view thereof;

FIG. 11 is a front elevation view thereof;

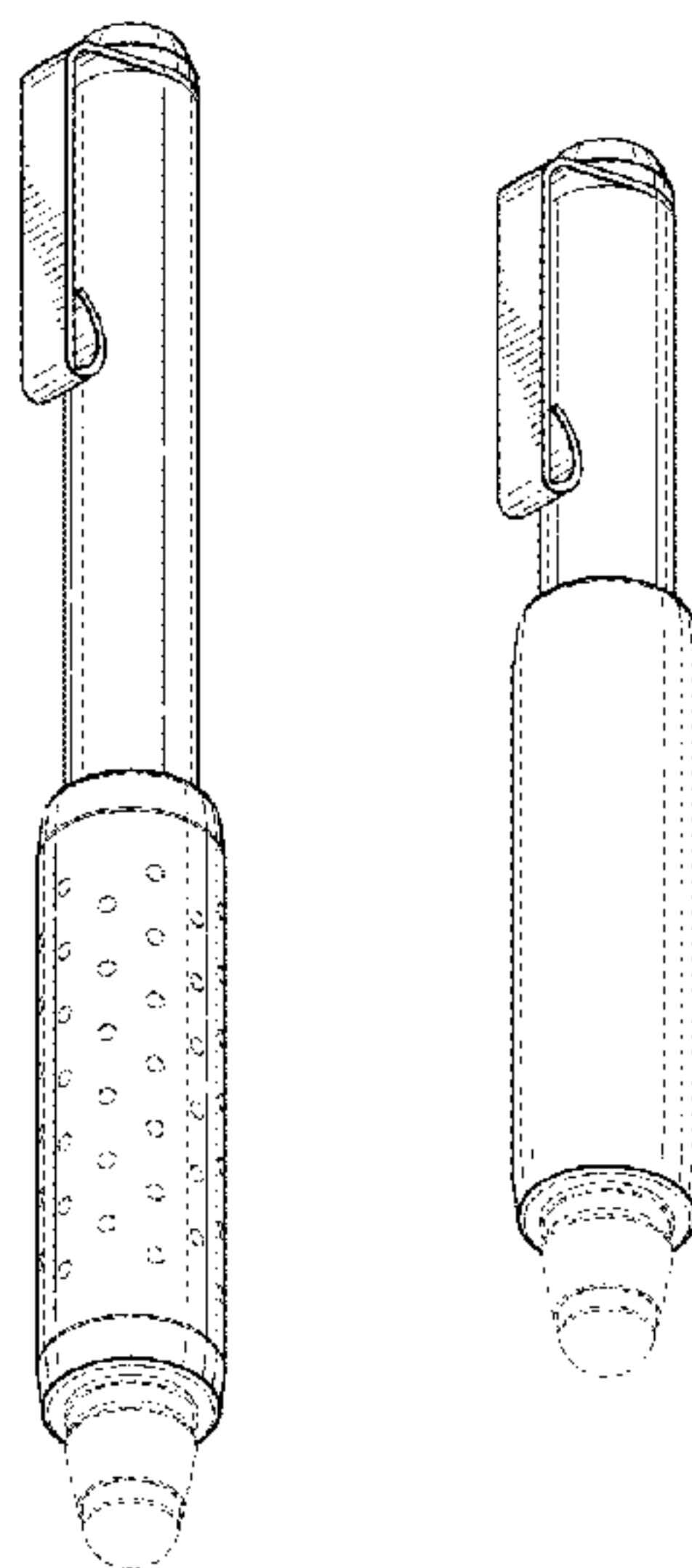
FIG. 12 is a rear elevation view thereof;

FIG. 13 is a front bottom right isometric view thereof; and,

FIG. 14 is a front bottom right isometric view thereof, with the stretchable stylus pen shown in a retracted position.

The broken lines shown in FIGS. 1, 2, 4-9, and 11-14 illustrate environmental subject matter and form no part of the claimed design.

**1 Claim, 4 Drawing Sheets**



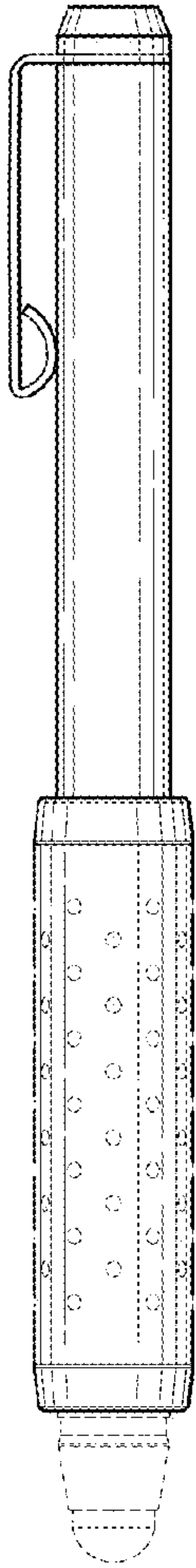
# US D682,276 S

Page 2

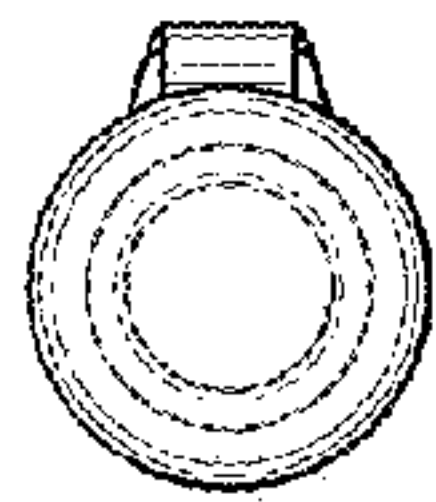
---

## U.S. PATENT DOCUMENTS

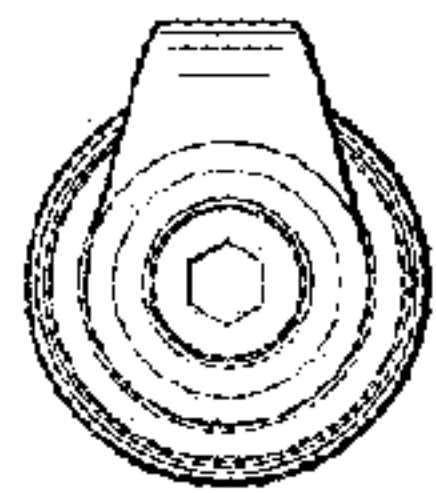
D628,640 S	*	12/2010	Wang	.....	D19/50		
D642,619 S	*	8/2011	Kermoal	.....	D19/48		
D644,227 S	*	8/2011	Son	.....	D14/411		
							* cited by examiner
						D655,292 S	* 3/2012 Nakata ..... D14/411
						D669,896 S	* 10/2012 Nakata ..... D14/411



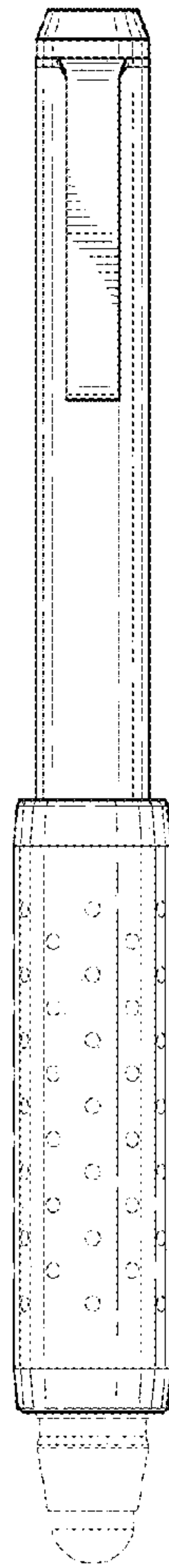
*Fig. 1.*



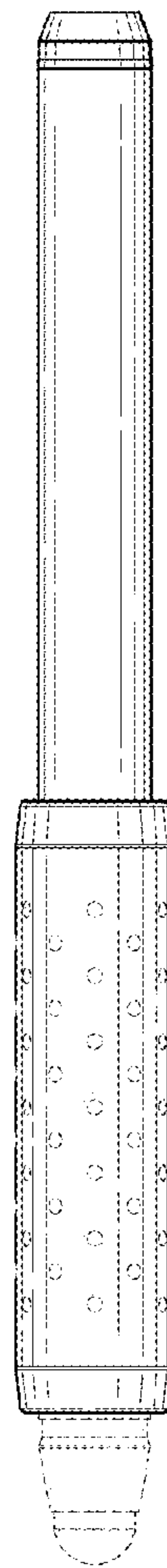
*Fig. 2.*



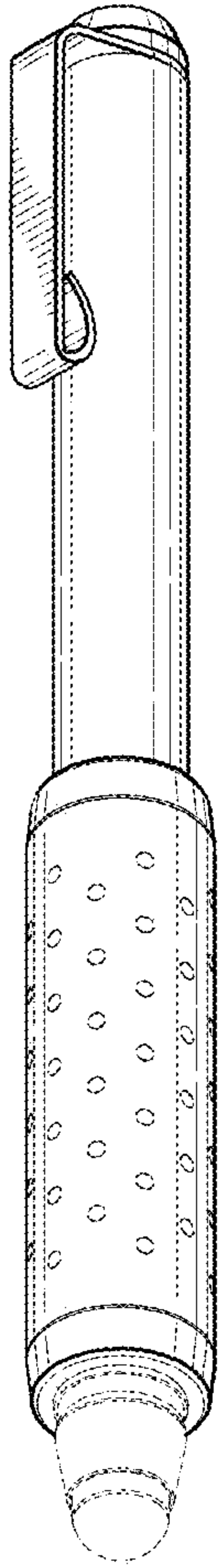
*Fig. 3.*



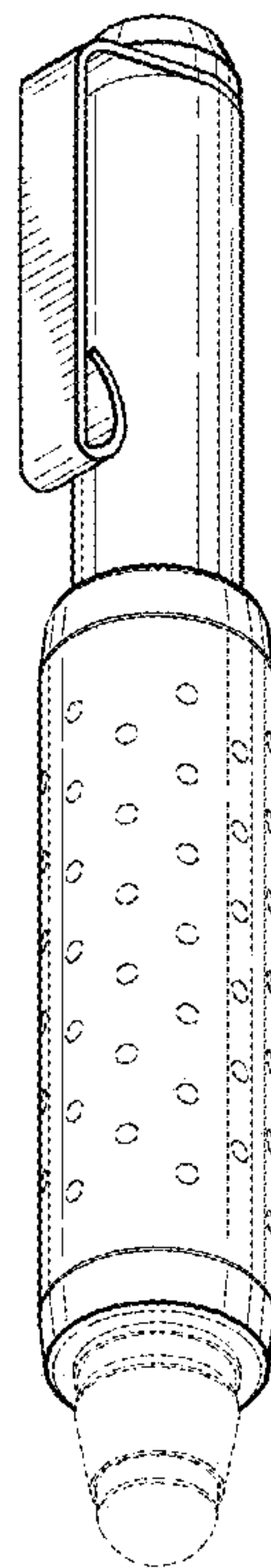
*Fig. 4.*



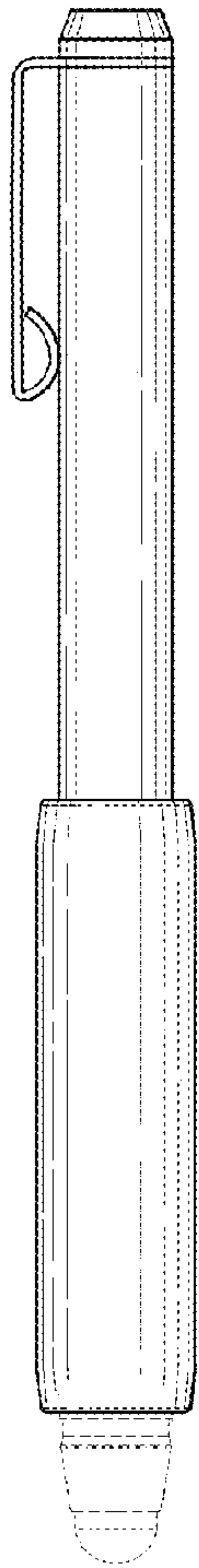
*Fig. 5.*



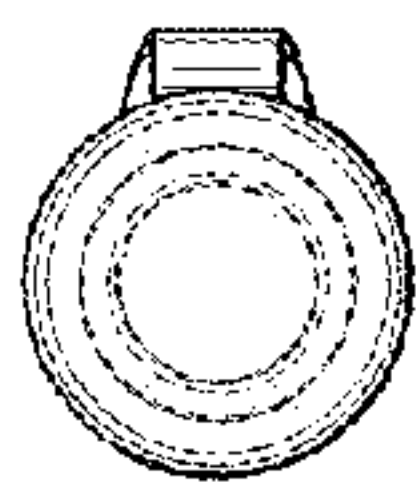
*Fig. 6.*



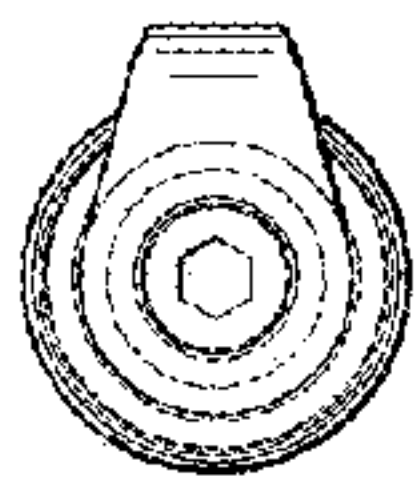
*Fig. 7.*



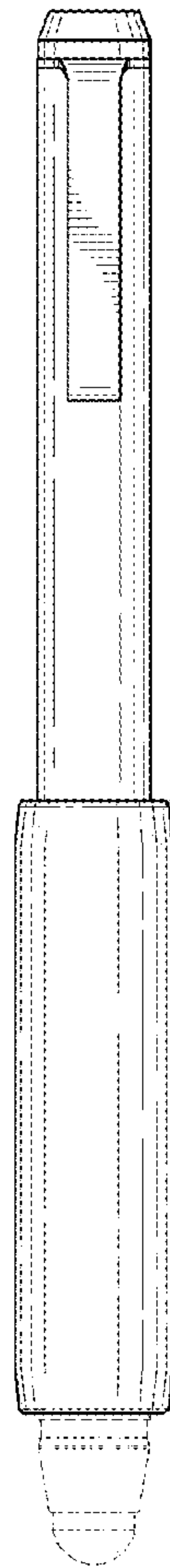
*Fig. 8.*



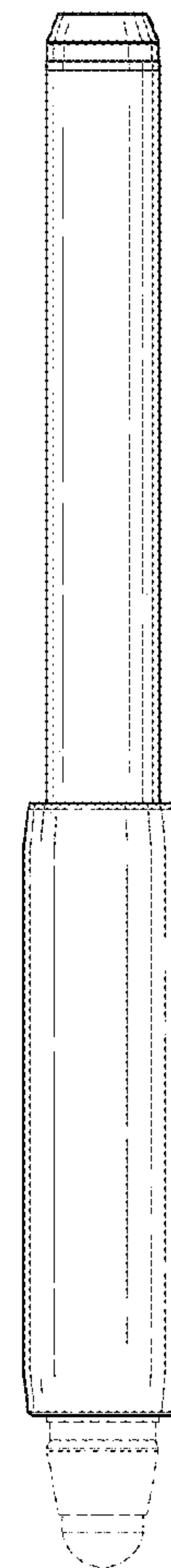
*Fig. 9.*



*Fig. 10.*

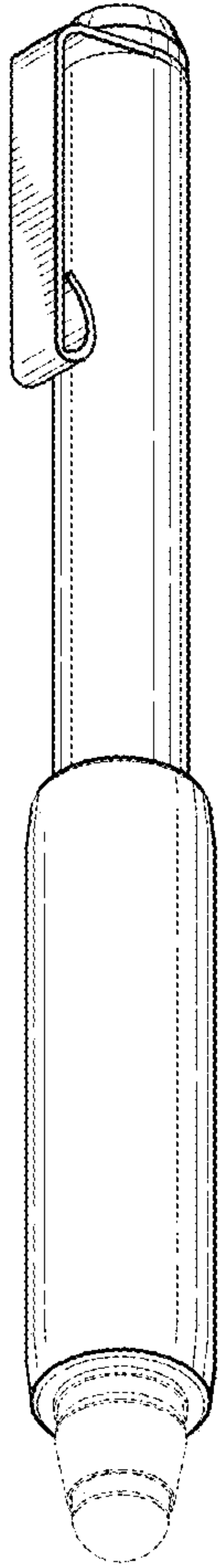


*Fig. 11.*

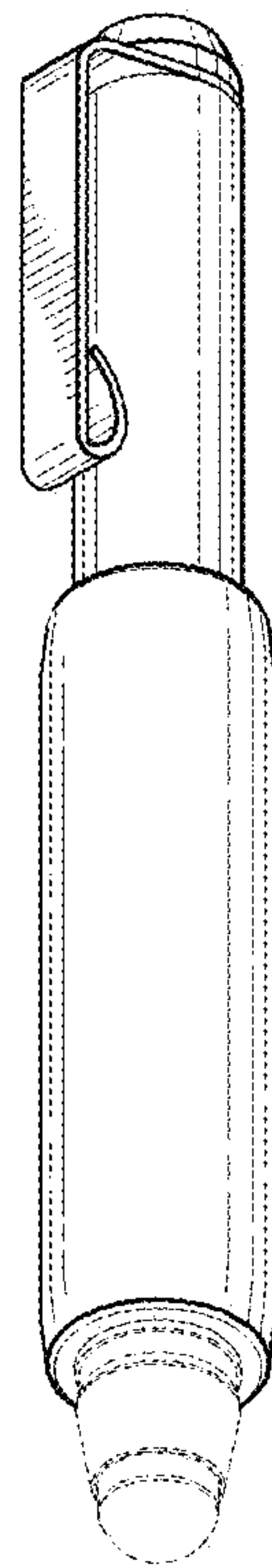


*Fig. 12.*





*Fig. 13.*



*Fig. 14.*