



US00D682267S

(12) **United States Design Patent**
Mase

(10) **Patent No.:** **US D682,267 S**

(45) **Date of Patent:** **** May 14, 2013**

(54) **IMAGE DISPLAY DEVICE**

(75) Inventor: **Yosuke Mase**, Nagoya (JP)

(73) Assignee: **Brother Industries, Ltd.**, Nagoya (JP)

(**) Term: **14 Years**

(21) Appl. No.: **29/401,621**

(22) Filed: **Sep. 13, 2011**

(30) **Foreign Application Priority Data**

Mar. 18, 2011 (JP) 2011-6299

(51) **LOC (9) Cl.** **14-02**

(52) **U.S. Cl.**
USPC **D14/372**

(58) **Field of Classification Search** D14/372,
D14/432, 496, 299; D16/330, 130; 345/8;
351/158

See application file for complete search history.

(56) **References Cited**

U.S. PATENT DOCUMENTS

D337,320 S * 7/1993 Hunter et al. D14/372
D537,078 S * 2/2007 Tanaka et al. D14/372

D559,250 S * 1/2008 Pombo D14/372
D609,236 S * 2/2010 Matsumoto et al. D14/372
D659,136 S * 5/2012 Matsumoto D14/372
D659,137 S * 5/2012 Matsumoto D14/372
2011/0012814 A1* 1/2011 Tanaka 345/8
2011/0267321 A1* 11/2011 Hayakawa 345/204

* cited by examiner

Primary Examiner — Austin Murphy

(74) *Attorney, Agent, or Firm* — Oliff & Berridge PLC

(57) **CLAIM**

The ornamental design for an image display device, as shown and described.

DESCRIPTION

FIG. 1 is a perspective view of an image display device;
FIG. 2 is a front view thereof;
FIG. 3 is a top view thereof;
FIG. 4 is a right-side view thereof;
FIG. 5 is a left-side view thereof;
FIG. 6 is a rear view thereof;
FIG. 7 is a bottom view thereof; and,
FIG. 8 is another perspective view thereof.
The broken lines depict environmental subject matter only and form no part of the claimed design.

1 Claim, 7 Drawing Sheets

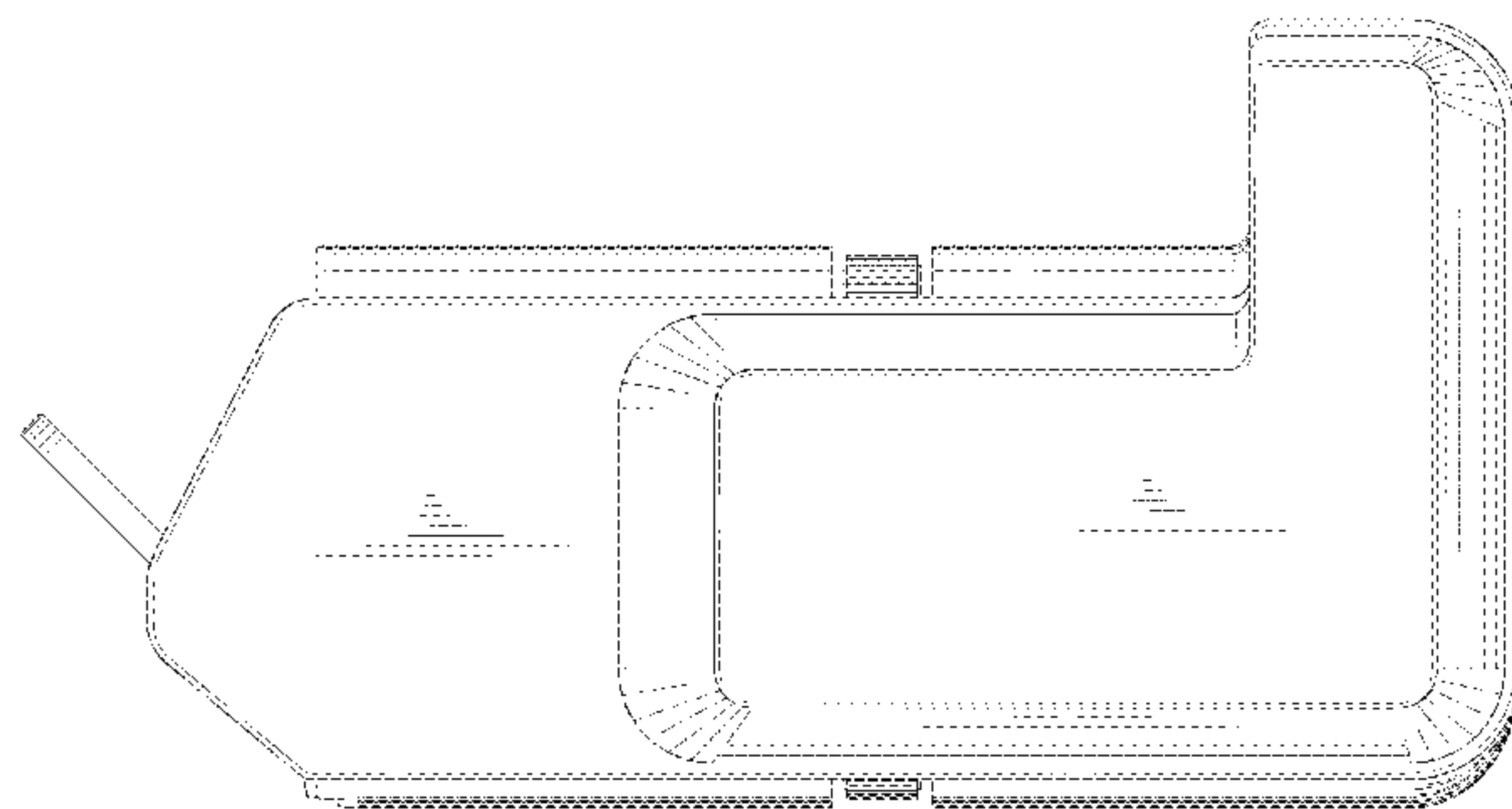
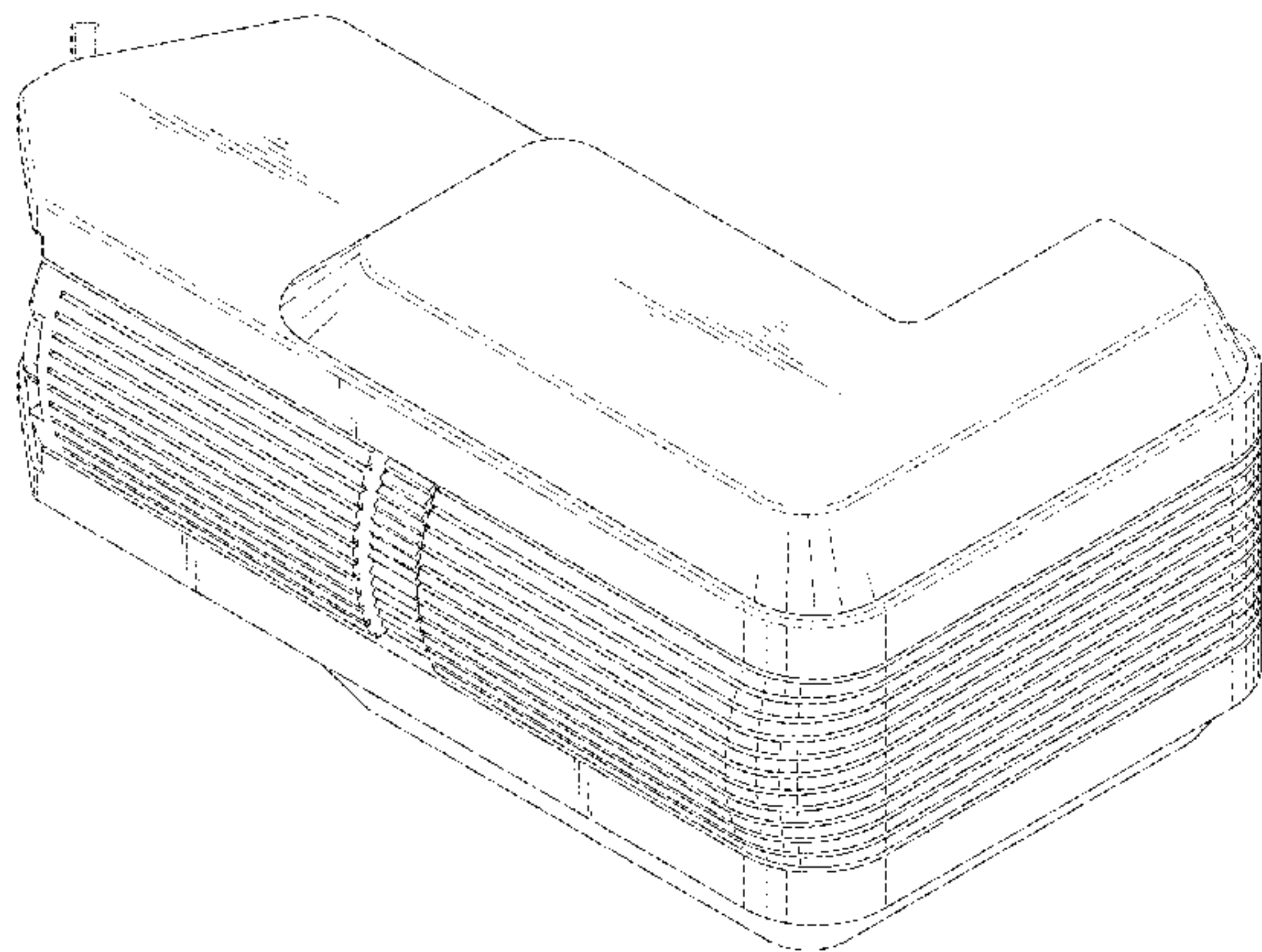

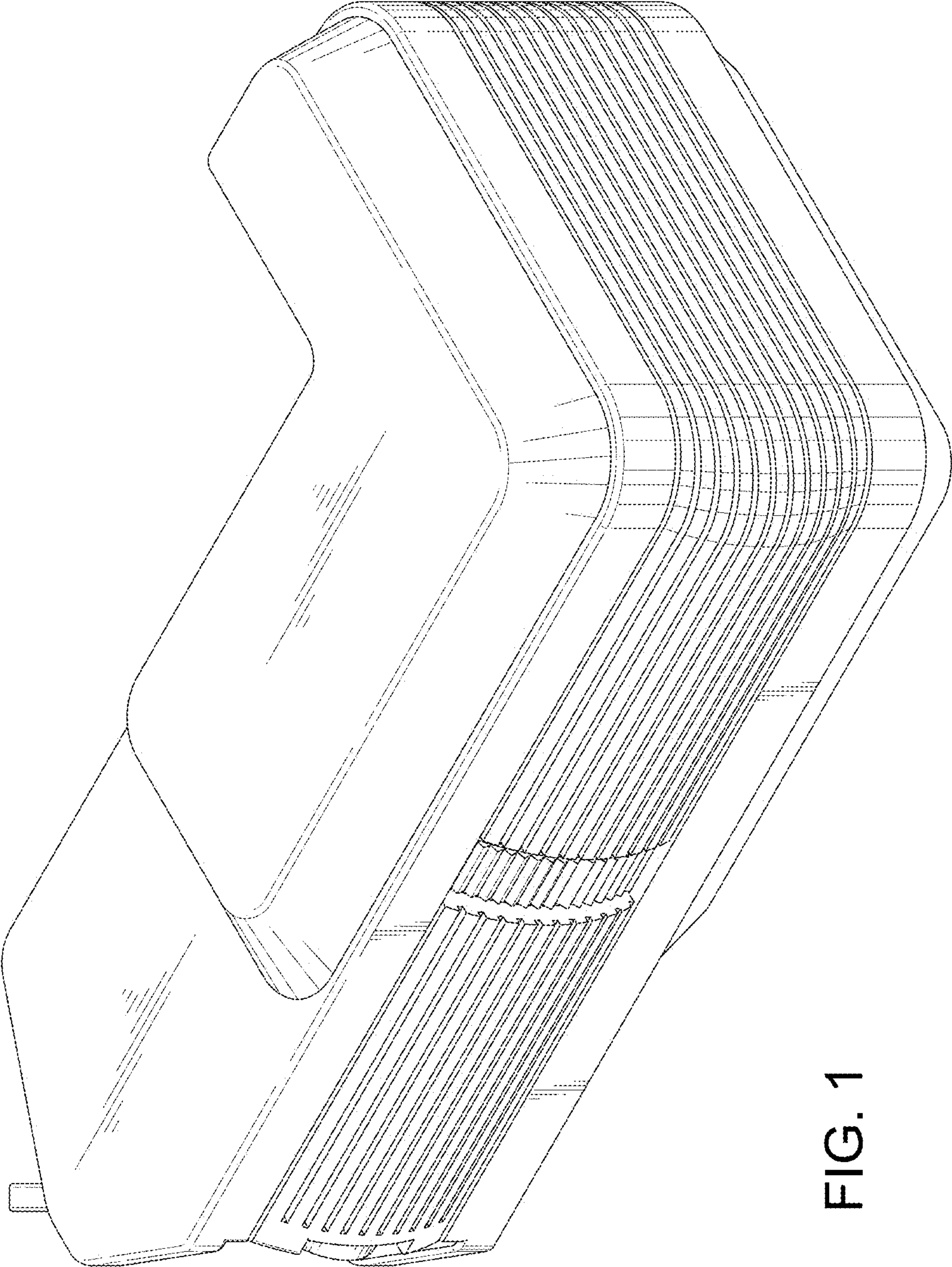

FIG. 1

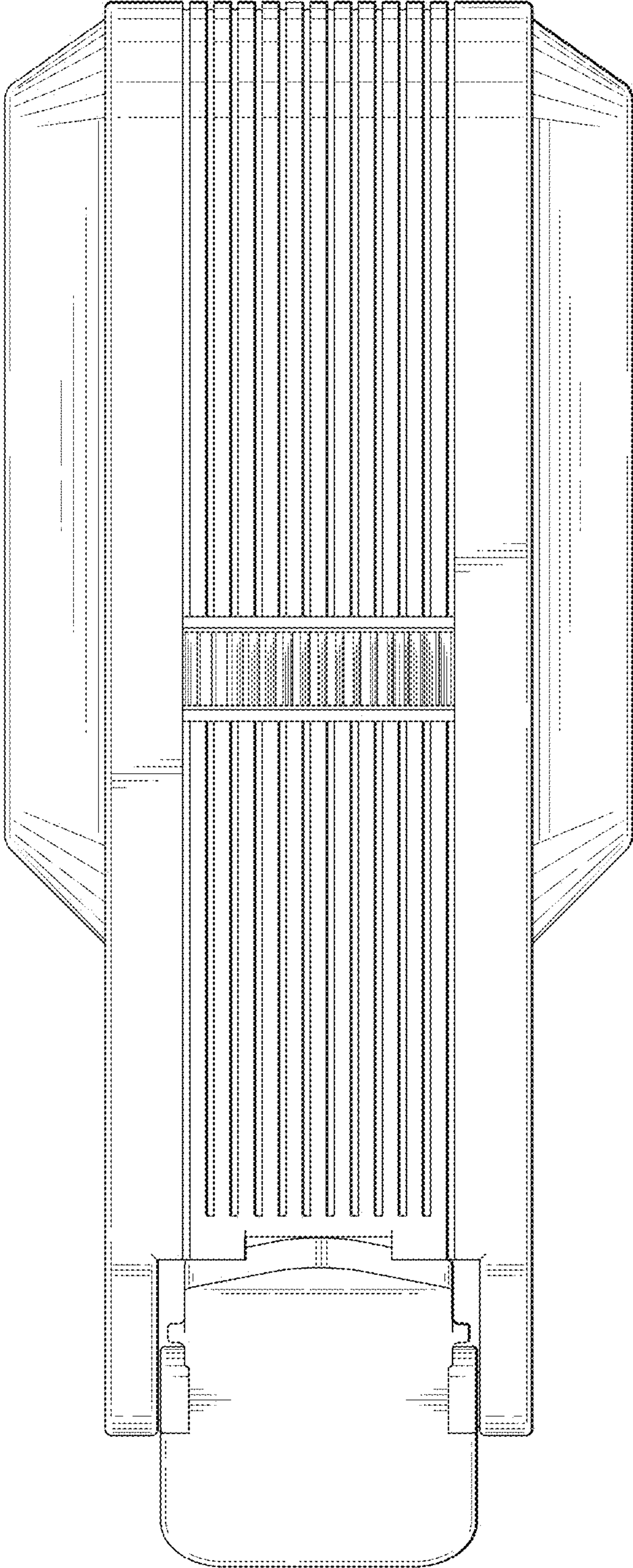

FIG. 2

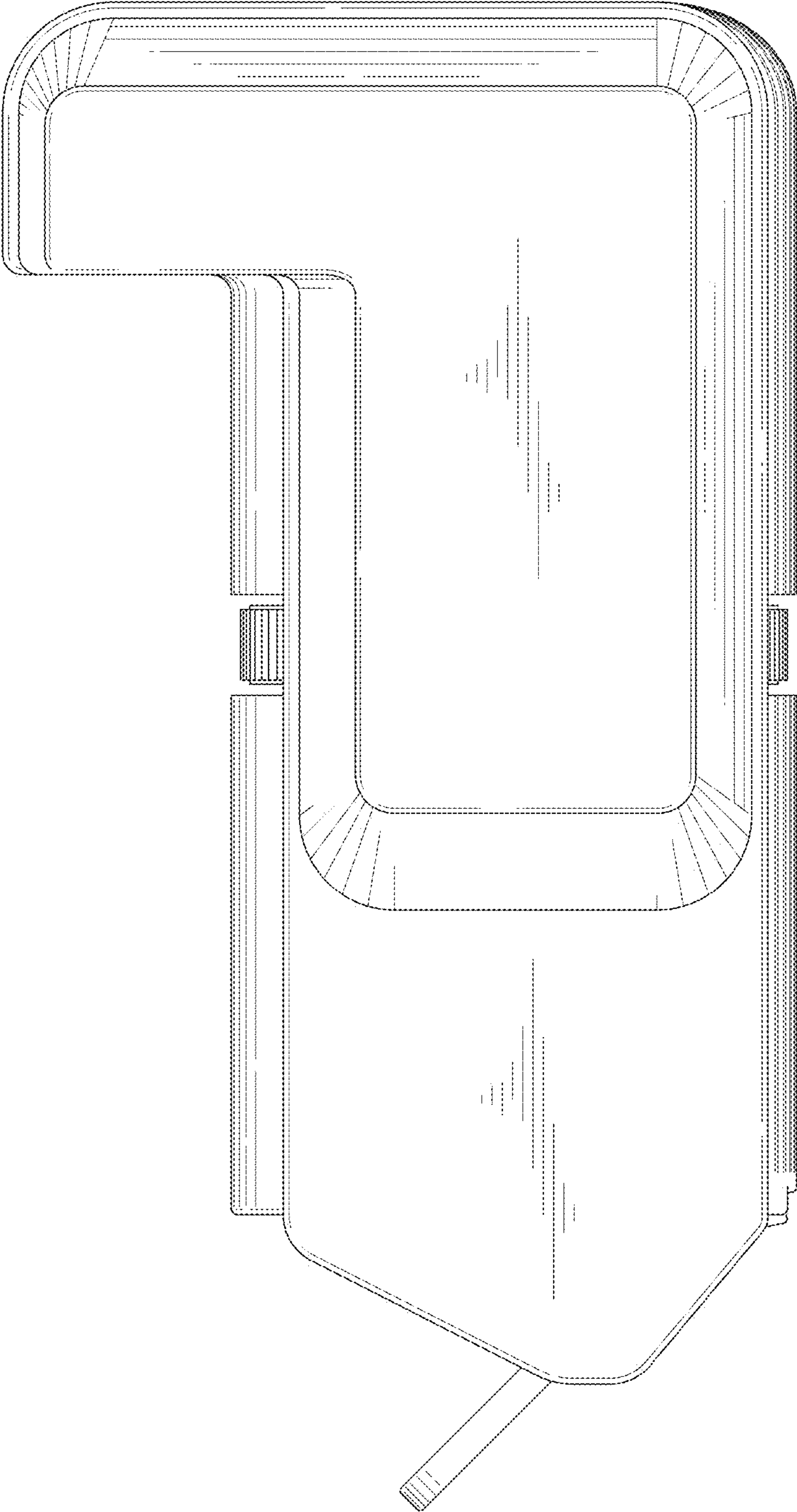

FIG. 3

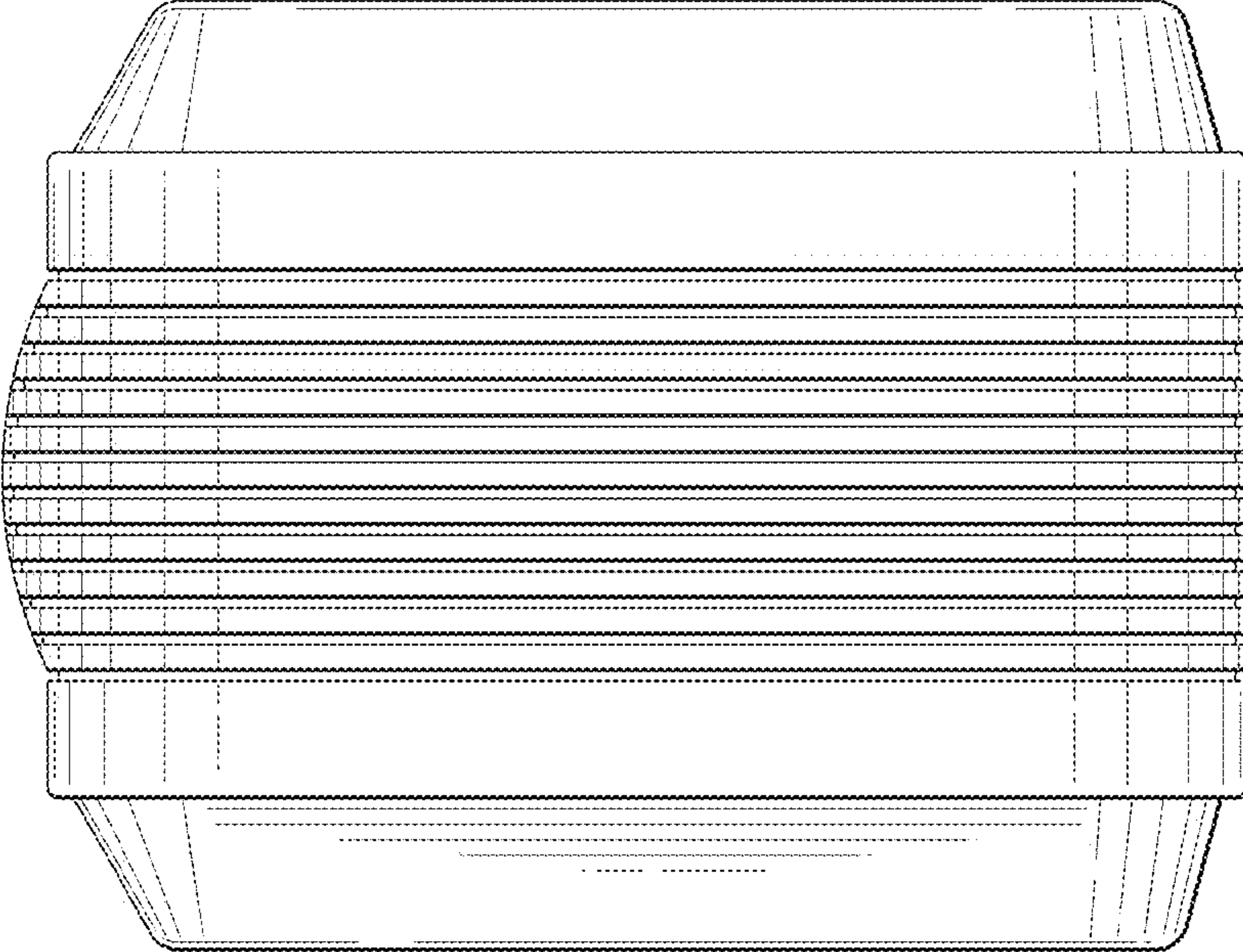

FIG. 4

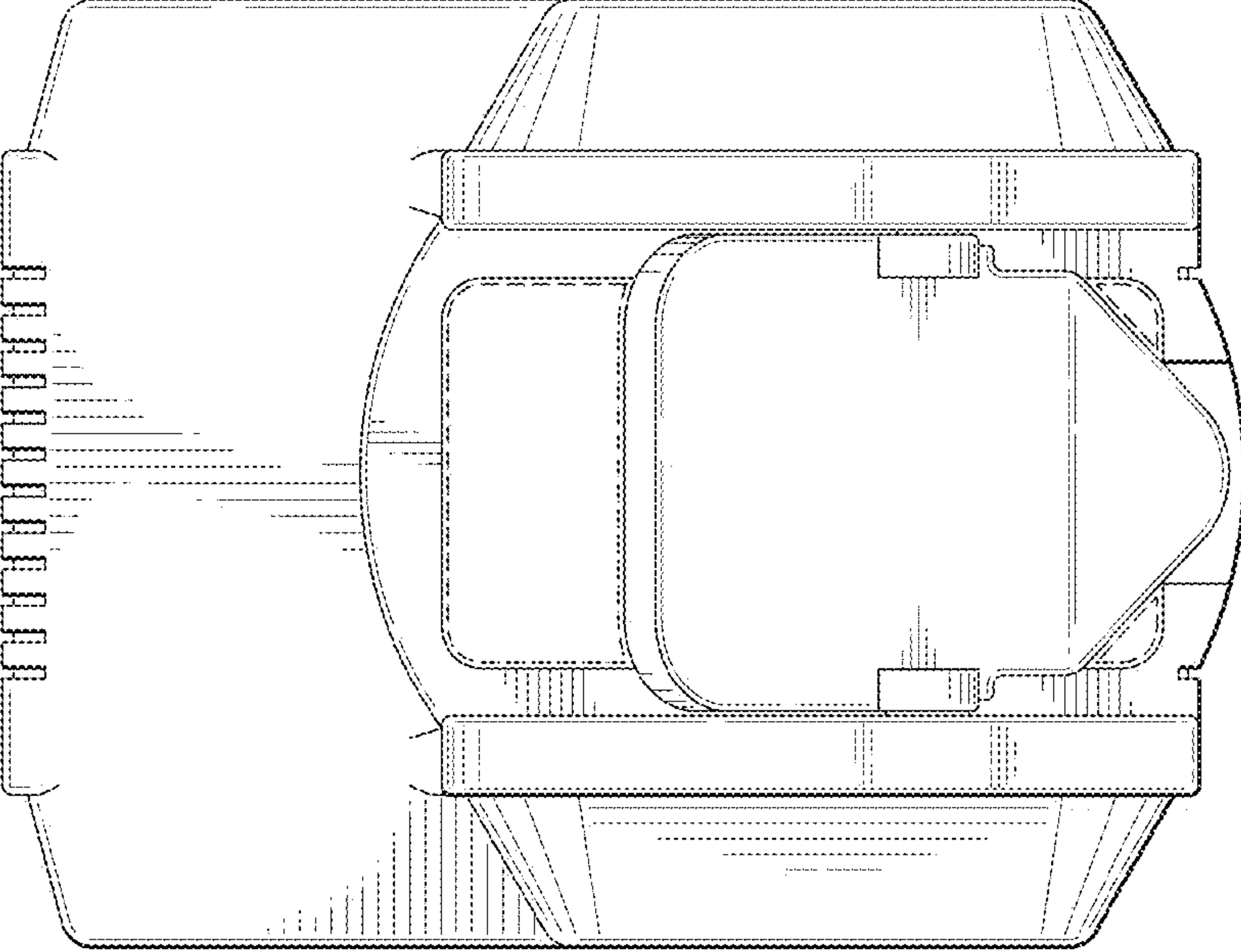

FIG. 5

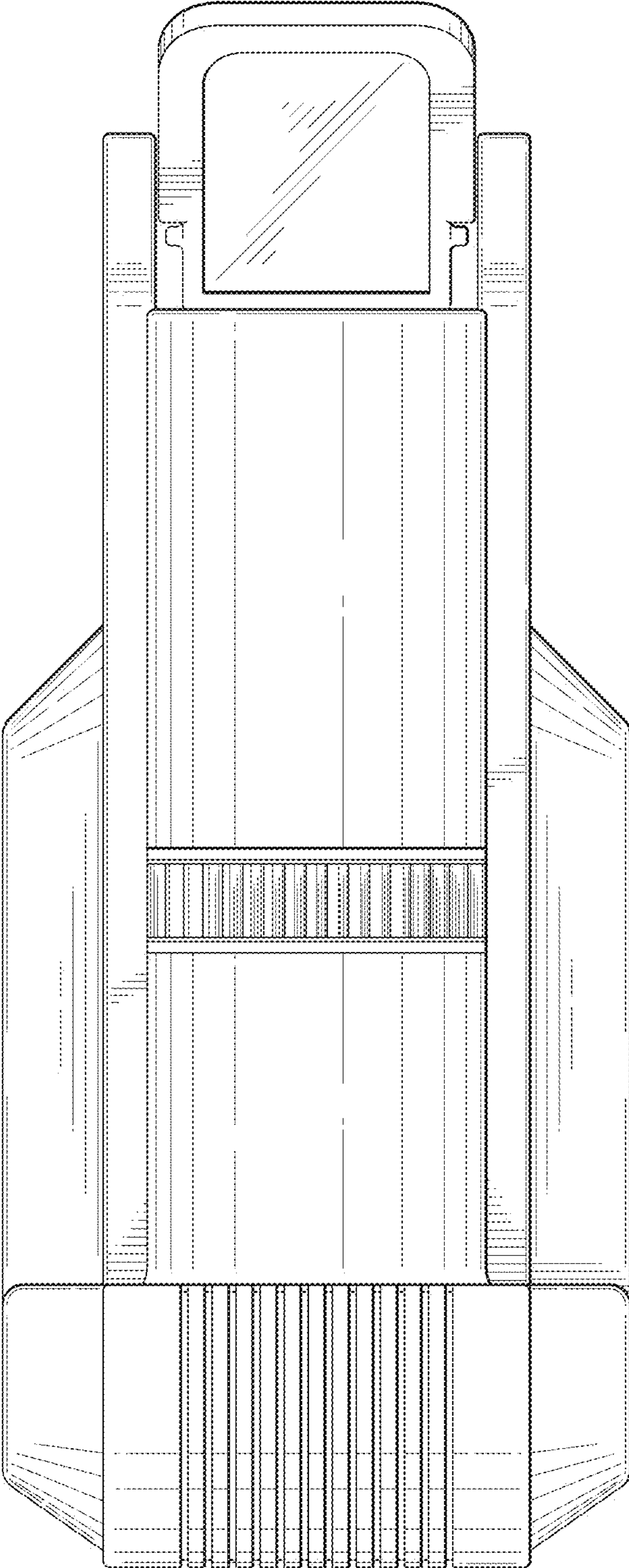

FIG. 6

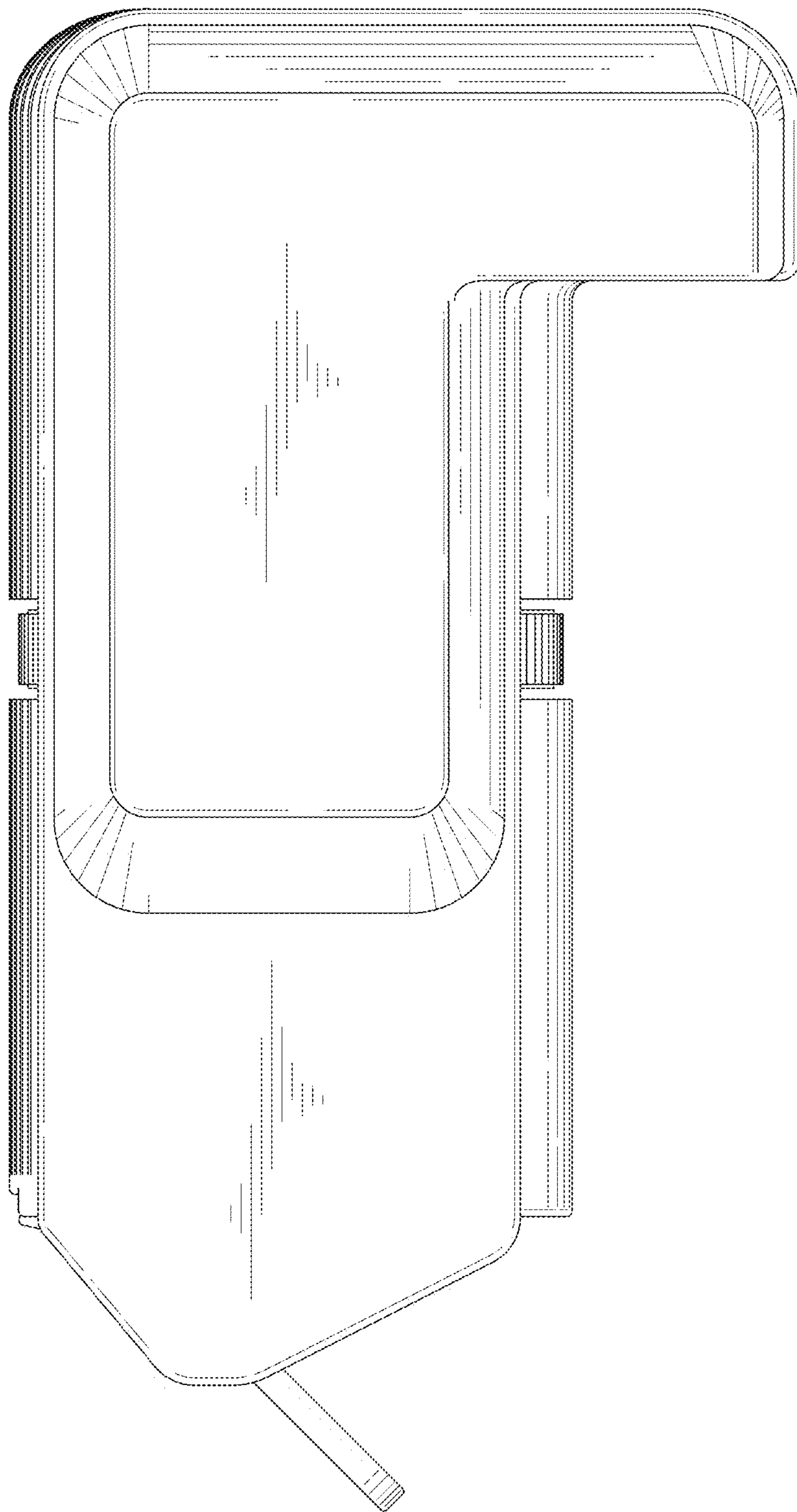

FIG. 7

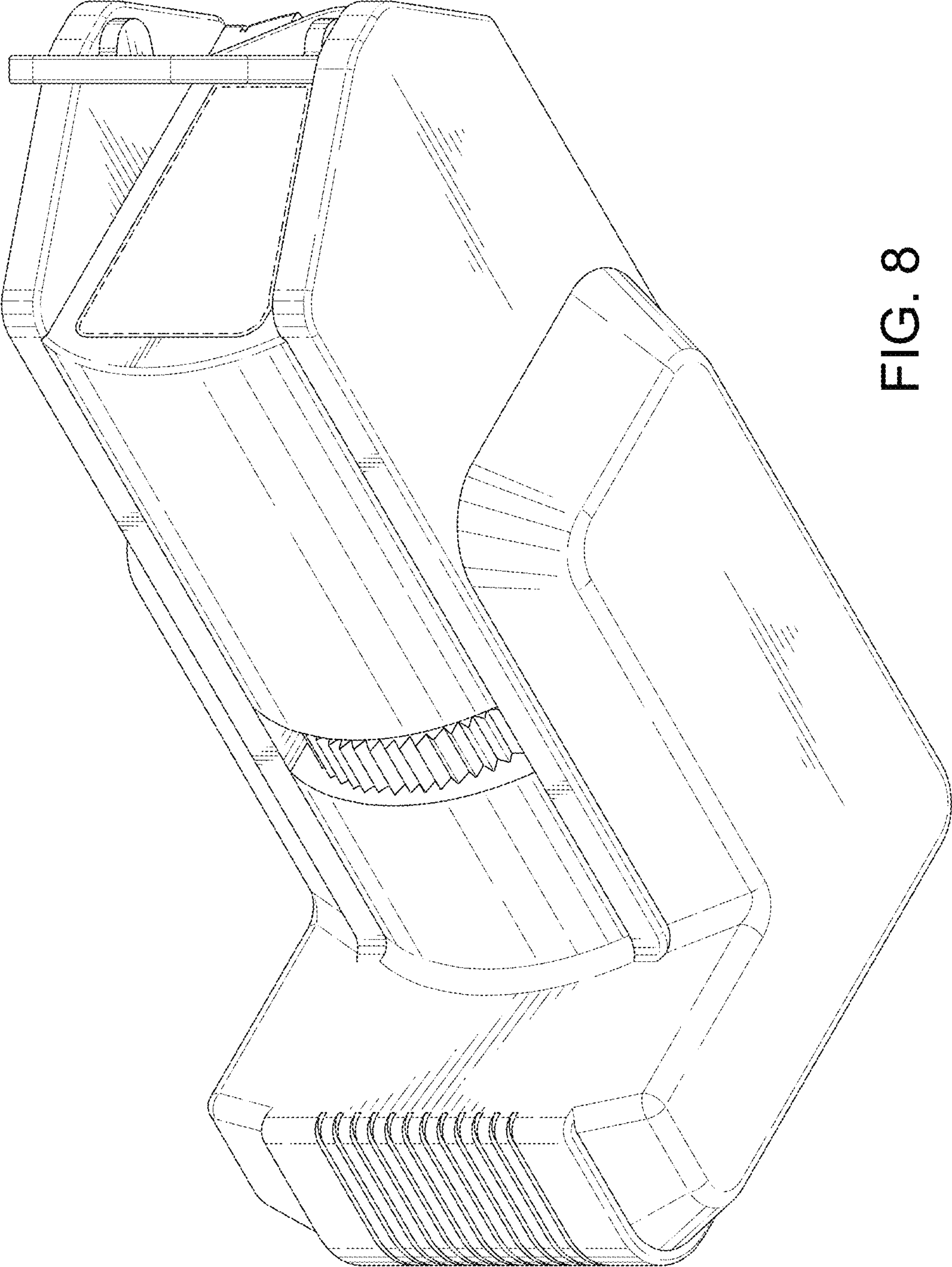

FIG. 8