



US00D682242S

(12) **United States Design Patent**  
**Yoo**

(10) **Patent No.:** **US D682,242 S**

(45) **Date of Patent:** **\*\* May 14, 2013**

(54) **MOBILE TERMINAL**

(75) Inventor: **Sang-Hun Yoo**, Seongnam-Si (KR)

(73) Assignee: **Samsung Electronics Co., Ltd.**,  
Suwon-si (KR)

(\*\*) Term: **14 Years**

(21) Appl. No.: **29/427,680**

(22) Filed: **Jul. 20, 2012**

(30) **Foreign Application Priority Data**

Mar. 6, 2012 (KR) ..... 30-2012-0010559

(51) **LOC (9) Cl.** ..... **14-03**

(52) **U.S. Cl.**  
USPC ..... **D14/138 AA**

(58) **Field of Classification Search** ..... D14/138 G,  
D14/138 AD, 341, 346, 138 R, 138 AA, 496,  
D14/203.1, 203.4, 203.7, 248, 218; 455/575.1,  
455/556.2, 575.3, 575.4; D21/517; 379/433.01,  
379/433.04, 433.12, 433.13; D10/65, 78,  
D10/104; D13/168

See application file for complete search history.

(56) **References Cited**

**U.S. PATENT DOCUMENTS**

- D554,612 S \* 11/2007 Wang ..... D14/138 AA
- D593,556 S \* 6/2009 Hofer et al. .... D14/346
- D597,511 S \* 8/2009 Park ..... D14/138 AA
- D603,831 S \* 11/2009 Ho et al. .... D14/138 AA
- D603,832 S \* 11/2009 Ho ..... D14/138 AA
- D612,849 S \* 3/2010 Ferrari et al. .... D14/346
- D613,740 S \* 4/2010 Ferrari et al. .... D14/346
- D619,554 S \* 7/2010 Kim et al. .... D14/138 AA
- D622,247 S \* 8/2010 Kwon et al. .... D14/138 AA

- D628,550 S \* 12/2010 Chen ..... D14/138 AA
- D628,973 S \* 12/2010 Ku ..... D14/138 AA
- D629,773 S \* 12/2010 Lee et al. .... D14/138 G
- D631,450 S \* 1/2011 Moss ..... D14/138 AA
- D647,870 S \* 11/2011 Lee ..... D14/138 AA
- D648,302 S \* 11/2011 Park et al. .... D14/138 AA
- D649,952 S \* 12/2011 Lee ..... D14/138 AA

(Continued)

**OTHER PUBLICATIONS**

LG C360 telephone, announced 2011, [online], [site visited Dec. 13, 2012]. Available from Internet, <URL: [http://www.gsmarena.com/lg\\_c360-4635.php](http://www.gsmarena.com/lg_c360-4635.php)>.\*

(Continued)

*Primary Examiner* — Jeffrey D Asch

(74) *Attorney, Agent, or Firm* — NSIP Law

(57) **CLAIM**

The ornamental design for a mobile terminal, as shown and described.

**DESCRIPTION**

FIG. 1 is a front perspective view of a mobile terminal; FIG. 2 is a front view of the mobile terminal of FIG. 1; FIG. 3 is a rear view of the mobile terminal of FIG. 1; FIG. 4 is a left-side view of the mobile terminal of FIG. 1; FIG. 5 is a right-side view of the mobile terminal of FIG. 1; FIG. 6 is a top plan view of the mobile terminal of FIG. 1; and, FIG. 7 is a bottom plan view of the mobile terminal of FIG. 1. The broken lines shown in the figures, which are immediately adjacent to the shaded areas and define unshaded regions, represent the bounds of the claim and are directed to environment and are for illustrative purposes only; the broken lines form no part of the claimed design. The broken lines have not been shown in FIG. 7 for convenience of illustration.

**1 Claim, 5 Drawing Sheets**

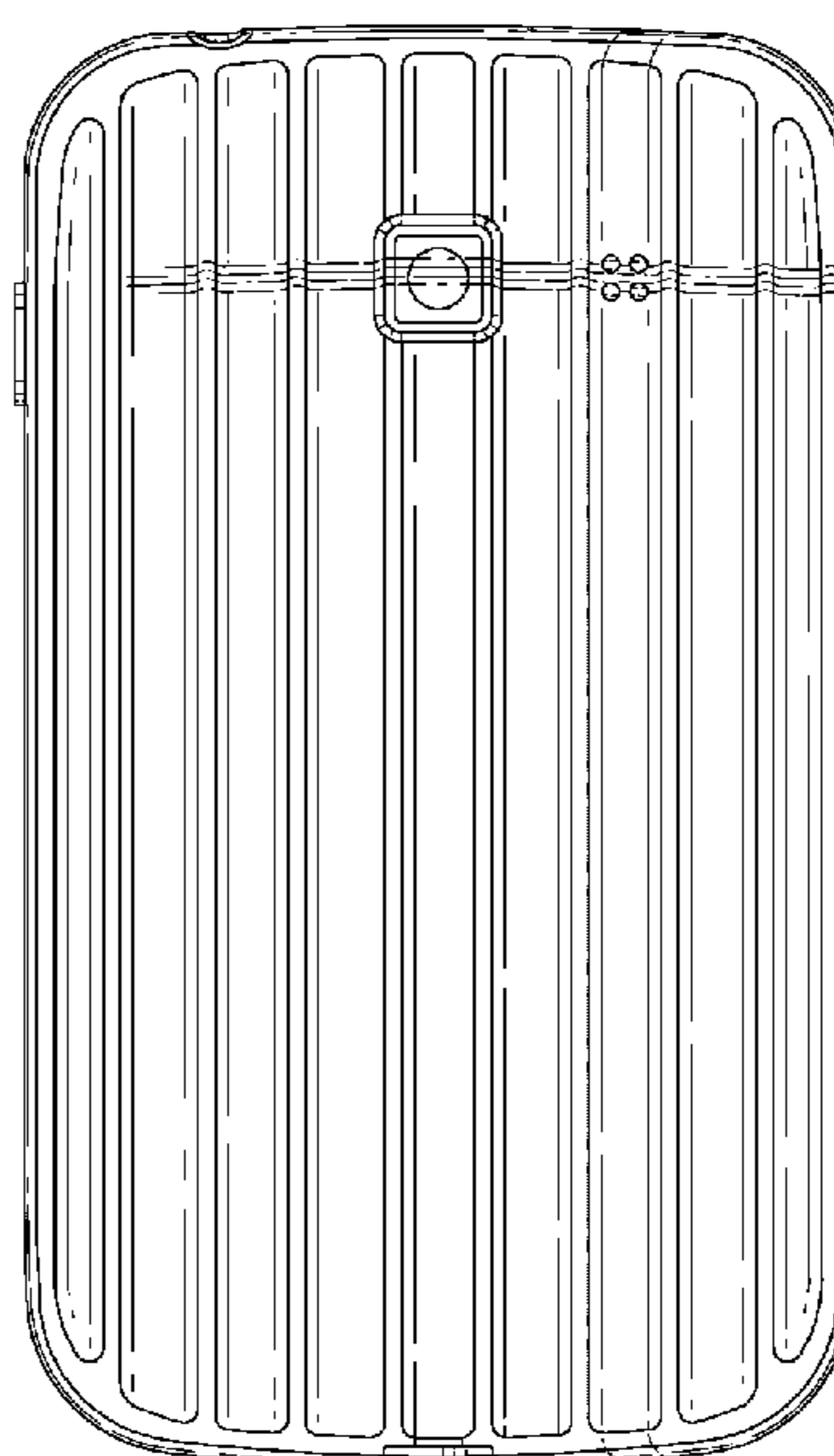
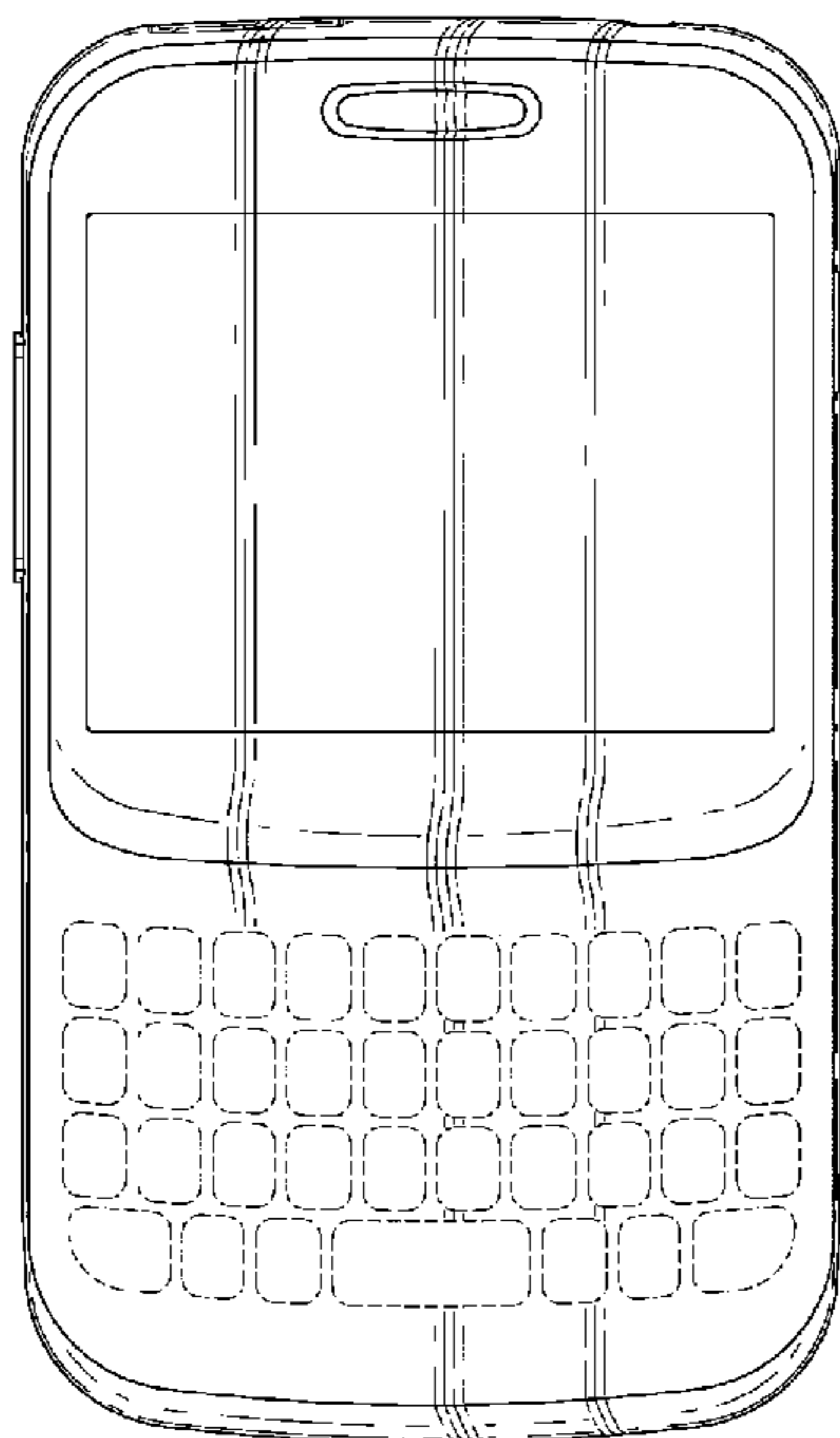

U.S. PATENT DOCUMENTS

D654,049 S \* 2/2012 Chung ..... D14/138 G  
D654,899 S \* 2/2012 Jung ..... D14/138 G  
D658,623 S \* 5/2012 Park et al. .... D14/138 AA  
D658,624 S \* 5/2012 Ferrari et al. .... D14/138 AA  
D660,817 S \* 5/2012 Ferrari et al. .... D14/138 AA  
8,301,200 B1 \* 10/2012 Lee et al. .... 455/566  
D670,693 S \* 11/2012 Li ..... D14/341  
D671,903 S \* 12/2012 Geum ..... D14/138 AA  
2006/0209032 A1 \* 9/2006 Chiang et al. .... 345/169

OTHER PUBLICATIONS

LG Optimus Pro C660 telephone, announced Jul. 2011, [online], [site visited Dec. 13, 2012]. Available from Internet, <URL: [http://www.gsmarena.com/lg\\_optimus\\_pro\\_c660-4040.php](http://www.gsmarena.com/lg_optimus_pro_c660-4040.php)>.\*  
Alcatel OT-803 telephone, announced Feb. 2011, [online], [site visited Dec. 13, 2012]. Available from Internet, <URL: [http://www.gsmarena.com/alcatel\\_ot\\_803-3801.php](http://www.gsmarena.com/alcatel_ot_803-3801.php)>.\*

Alcatel OT-358 telephone, announced Apr. 2012, [online], [site visited Dec. 13, 2012]. Available from Internet, <URL: [http://www.gsmarena.com/alcatel\\_ot\\_358-4727.php](http://www.gsmarena.com/alcatel_ot_358-4727.php)>.\*  
Samsung Ch@t 357 telephone, announced Q3 2012, [online], [site visited Dec. 13, 2012]. Available from Internet, <URL: [http://www.gsmarena.com/samsung\\_ch@t\\_357-4931.php](http://www.gsmarena.com/samsung_ch@t_357-4931.php)>.\*  
Plum Velocity telephone, announced Sep. 2011, [online], [site visited Dec. 13, 2012]. Available from Internet, <URL: [http://www.gsmarena.com/plum\\_velocity-4186.php](http://www.gsmarena.com/plum_velocity-4186.php)>.\*  
Vodafone 555 Blue telephone, announced Jul. 2011, [online], [site visited Dec. 13, 2012]. Available from Internet, <URL: [http://www.gsmarena.com/vodafone\\_555\\_blue-4052.php](http://www.gsmarena.com/vodafone_555_blue-4052.php)>.\*  
HTC ChaCha telephone, announced Feb. 2011, [online], [site visited Dec. 13, 2012]. Available from Internet, <URL: [http://www.gsmarena.com/htc\\_chacha-3787.php](http://www.gsmarena.com/htc_chacha-3787.php)>.\*

\* cited by examiner

FIG. 1

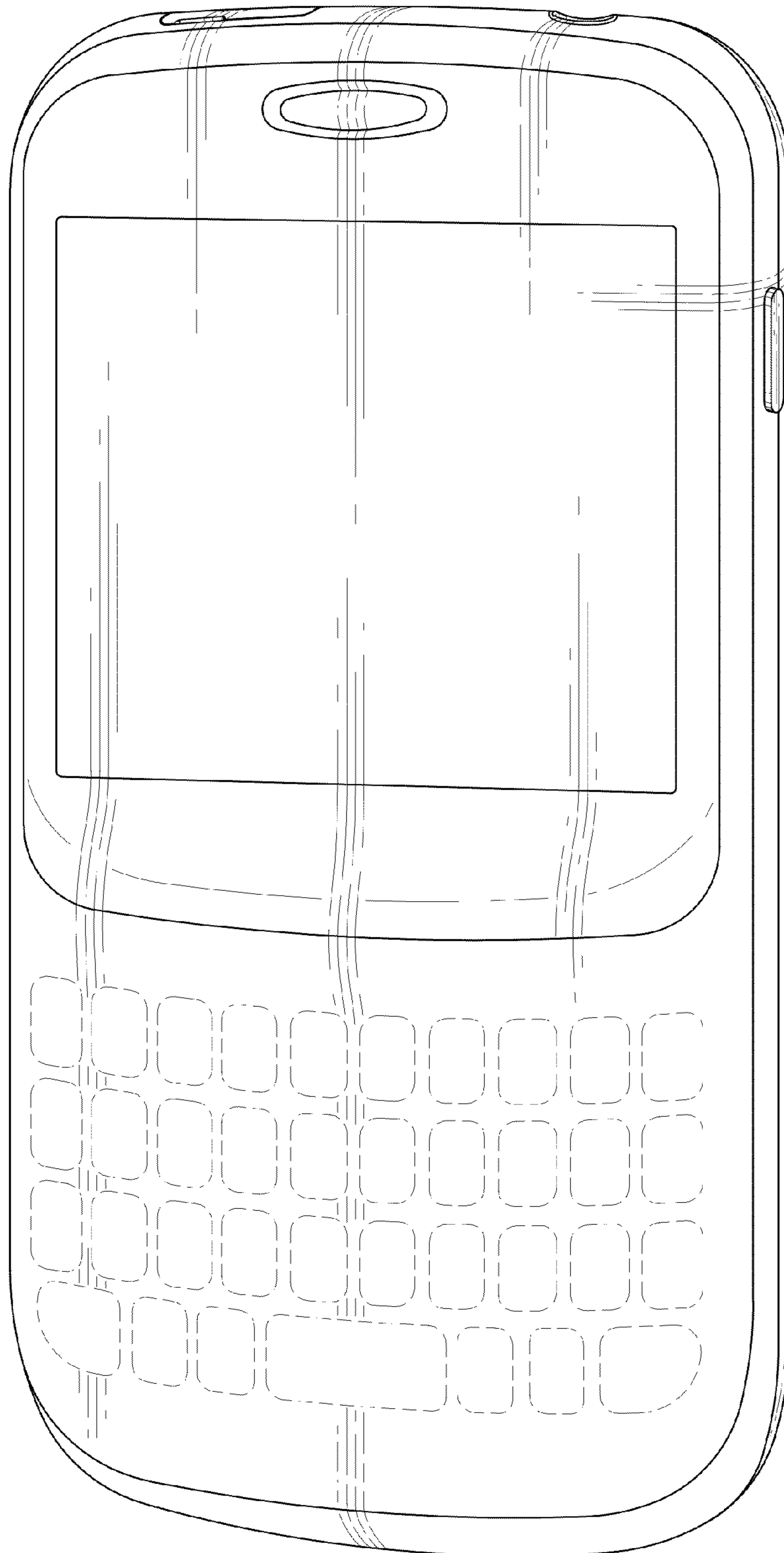

FIG. 2

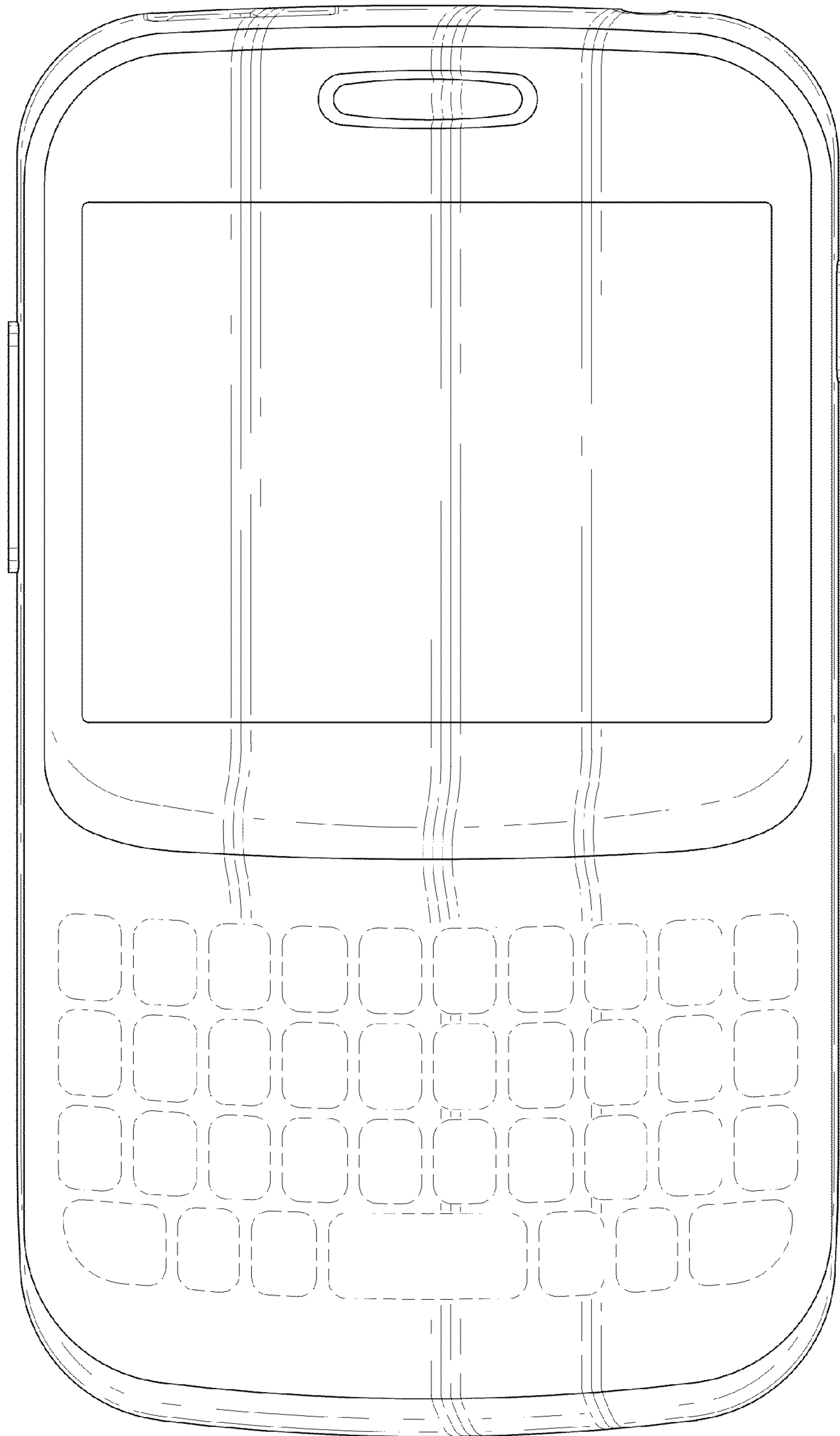

FIG. 3

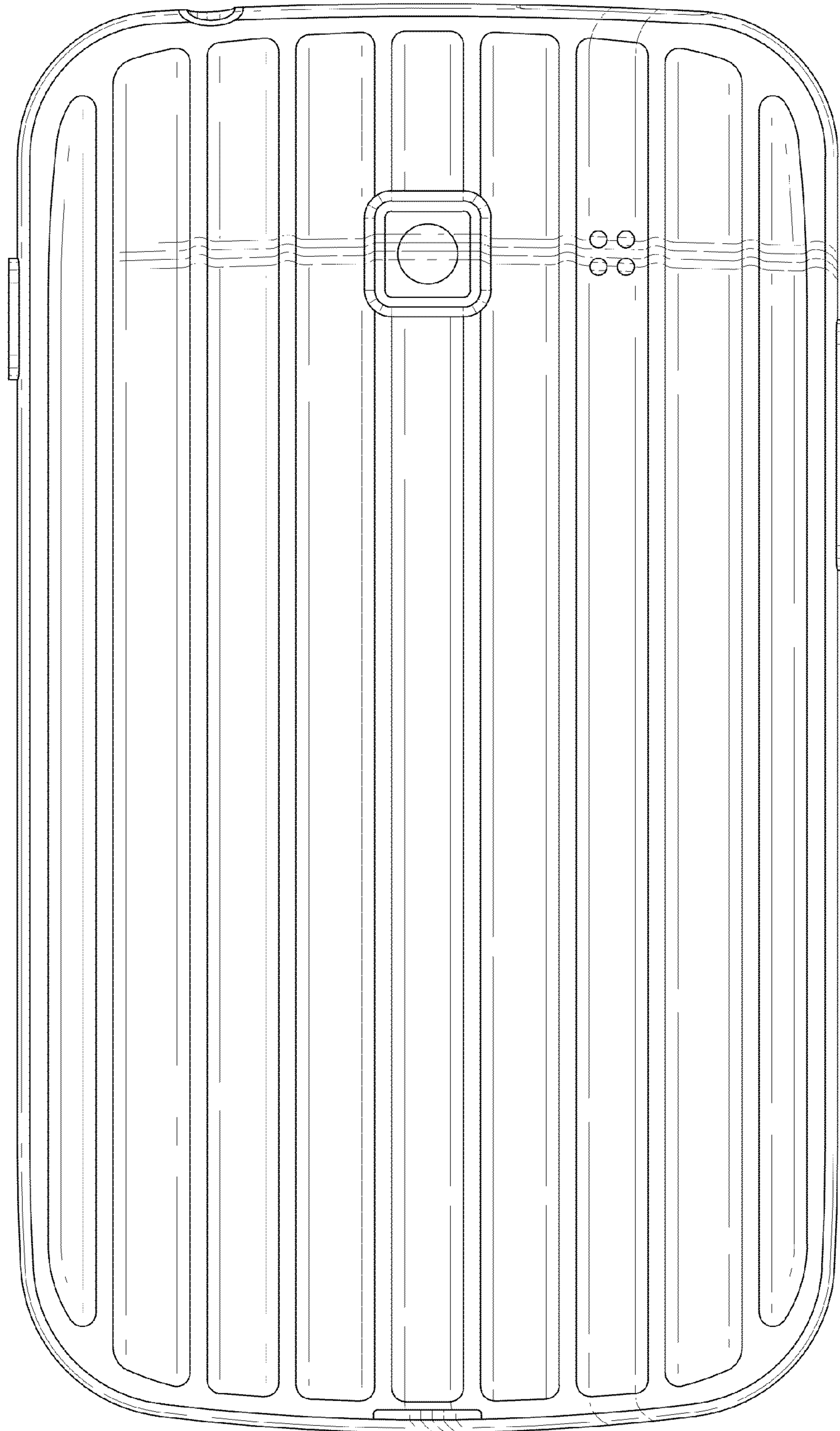

FIG. 4

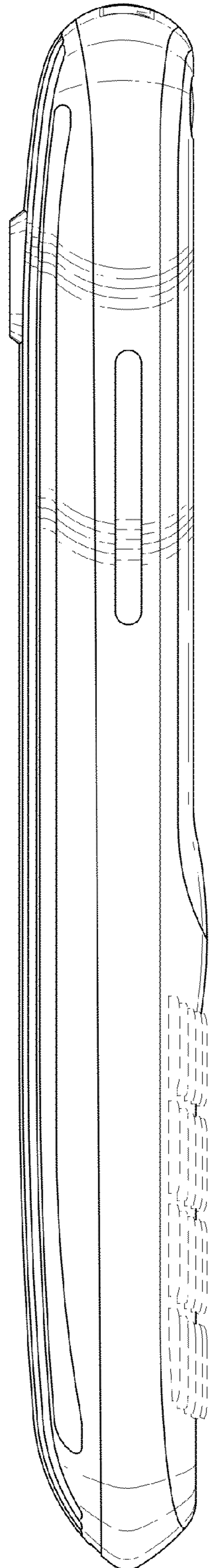

FIG. 5

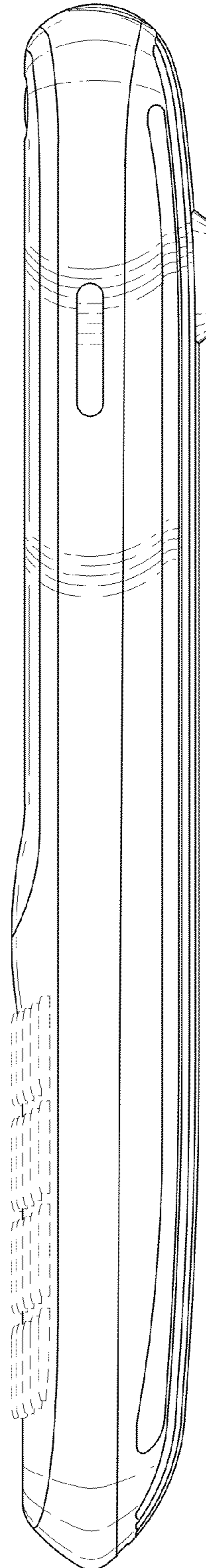

FIG. 6

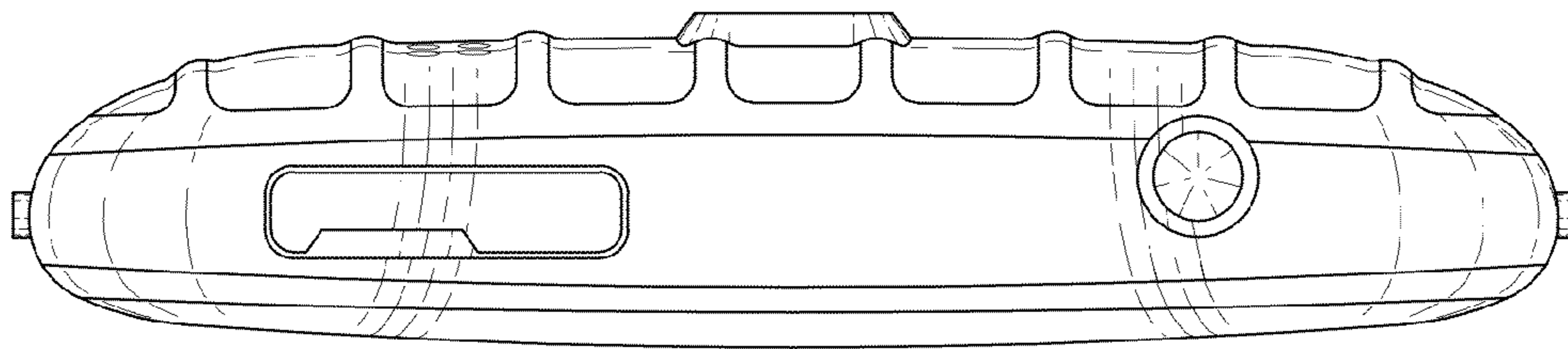

FIG. 7

