



US00D682200S

(12) **United States Design Patent**
Rautiainen

(10) **Patent No.:** **US D682,200 S**

(45) **Date of Patent:** **** May 14, 2013**

(54) **CHARGING STAND**

(75) Inventor: **Jukka Rautiainen**, Helsinki (FI)

(73) Assignee: **Nokia Corporation** (FI)

(**) Term: **14 Years**

(21) Appl. No.: **29/426,989**

(22) Filed: **Jul. 12, 2012**

(51) **LOC (9) Cl.** **13-02**

(52) **U.S. Cl.**
USPC **D13/108**

(58) **Field of Classification Search** D13/107–110,
D13/118–119, 184, 199; D14/251, 253,
D14/432, 434; 320/107–115
See application file for complete search history.

(56) **References Cited**

U.S. PATENT DOCUMENTS

D454,131 S *	3/2002	Lord	D14/434
D461,461 S *	8/2002	Adamson et al.	D14/147
D464,635 S *	10/2002	Oyama et al.	D14/147
D489,322 S *	5/2004	Sawai et al.	D13/108
D501,191 S *	1/2005	Siebke	D14/149
D568,327 S *	5/2008	Fitch et al.	D14/453

D646,268 S *	10/2011	DeLorenzo et al.	D14/253
D666,995 S *	9/2012	TerMeer	D14/217
D667,004 S *	9/2012	Goodrich	D14/253
2011/0127959 A1 *	6/2011	McGary et al.	320/114

* cited by examiner

Primary Examiner — Rosemary K Tarcza

(74) *Attorney, Agent, or Firm* — Banner & Witcoff, Ltd.

(57) **CLAIM**

The ornamental design for a charging stand, as shown and described.

DESCRIPTION

FIG. 1 is a perspective view of a charging stand showing my new design;
FIG. 2 is a front view thereof;
FIG. 3 is a rear view thereof;
FIG. 4 is a left side view thereof;
FIG. 5 is a right side view thereof;
FIG. 6 is a top view thereof; and,
FIG. 7 is a bottom view thereof.

The broken lines of the wireless charging stand and the unshaded regions therein are for illustrative purposes only and form no part of the claimed design.

1 Claim, 7 Drawing Sheets

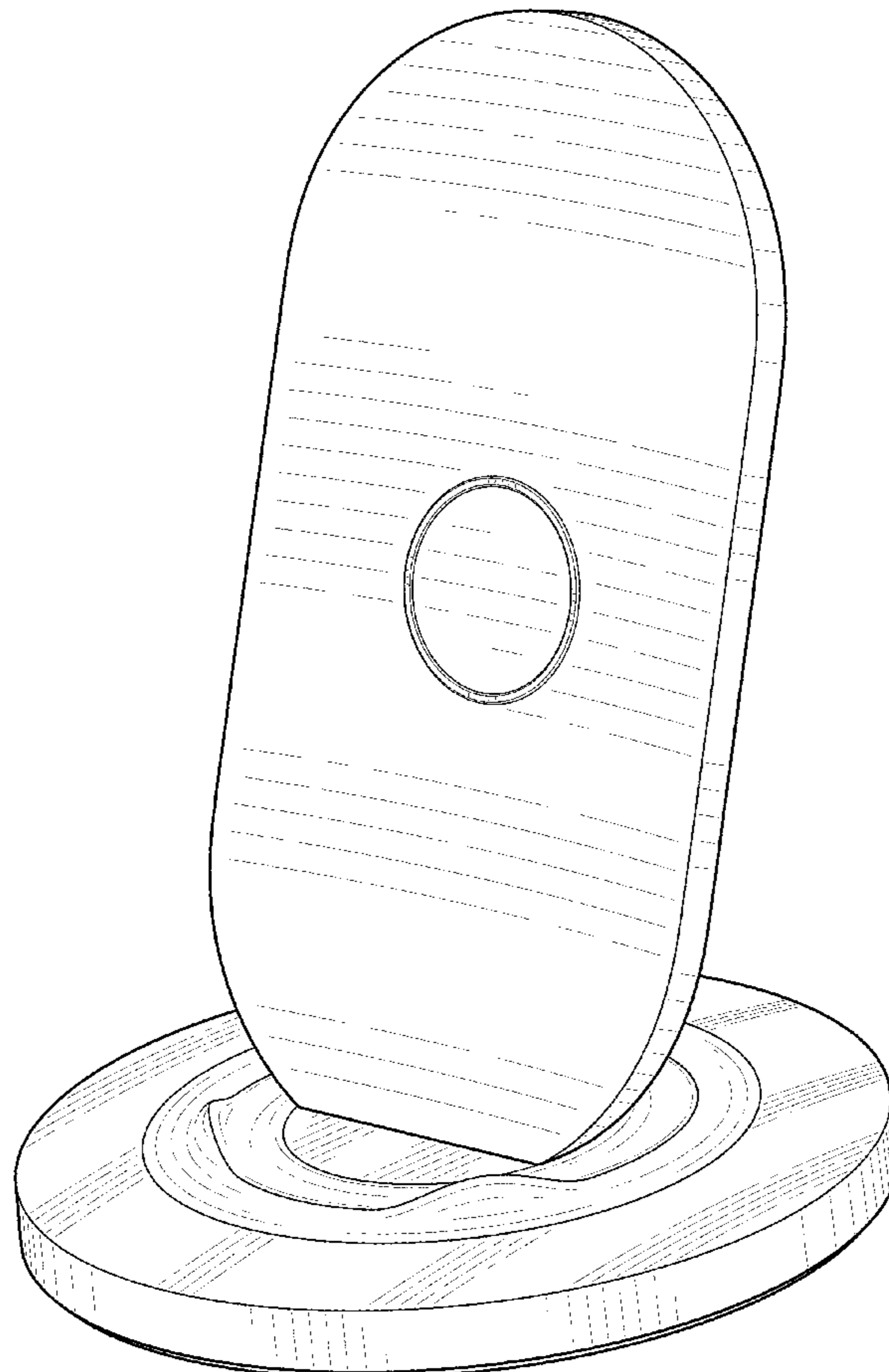

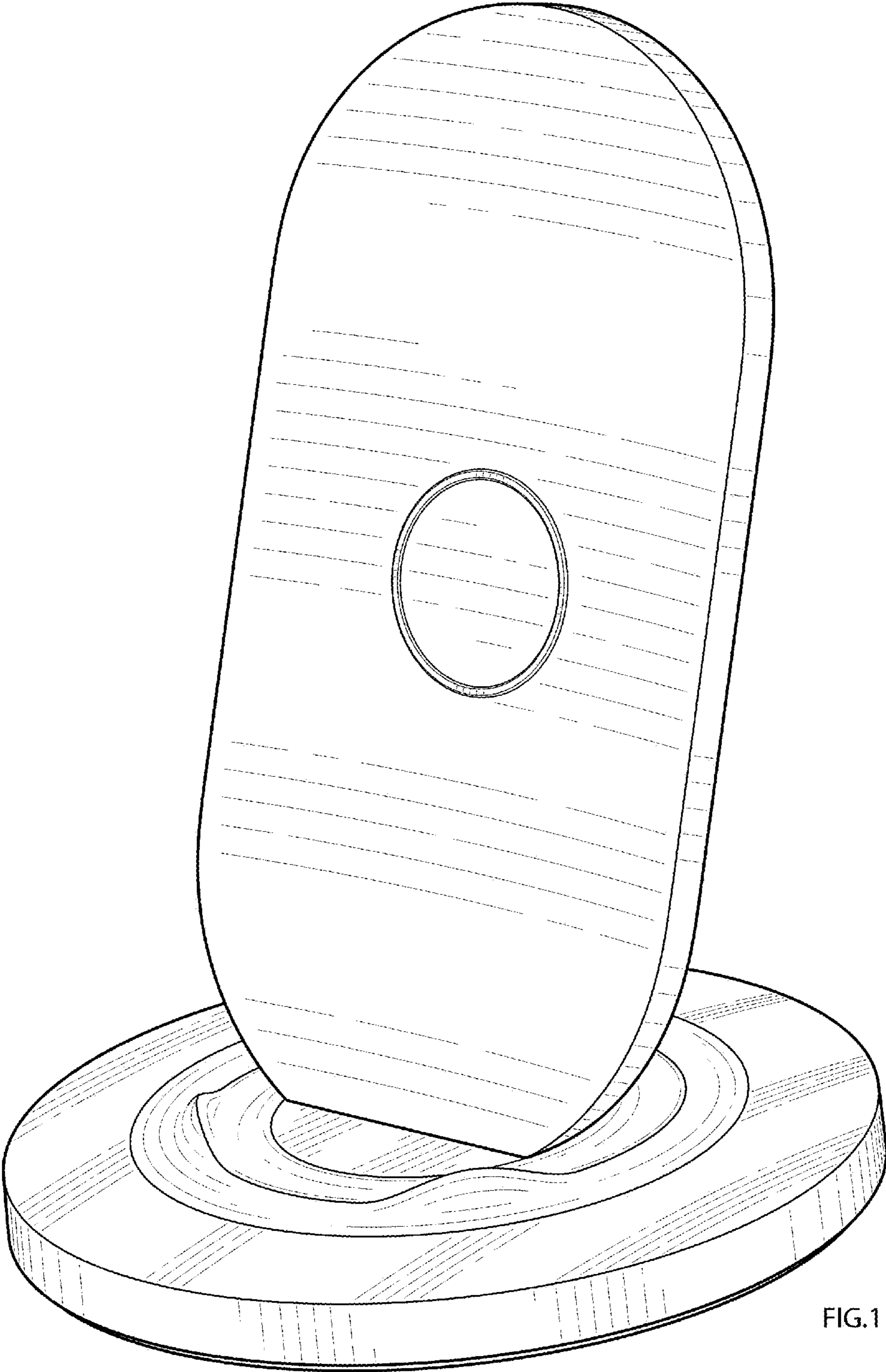

FIG.1

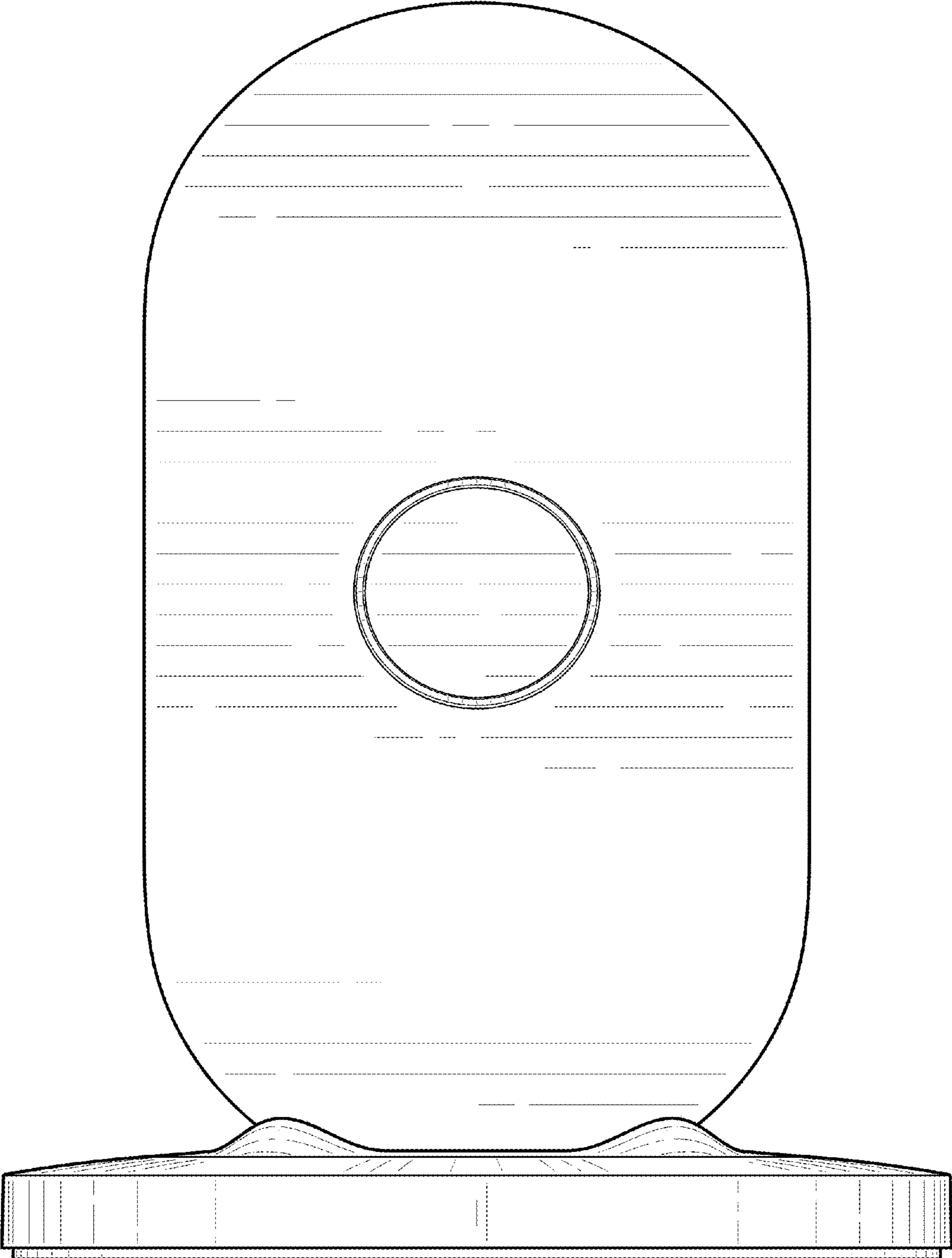

FIG. 2

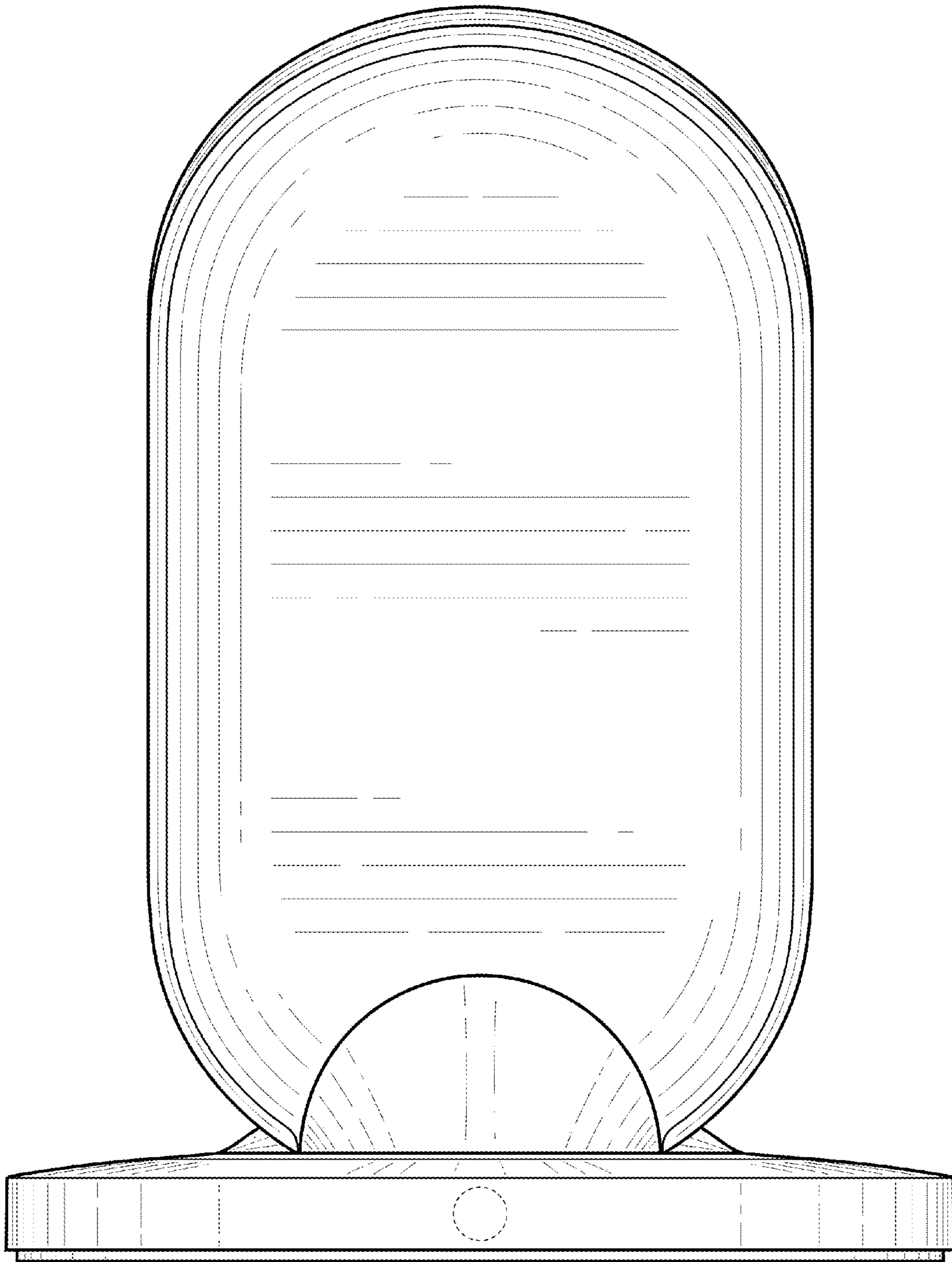

FIG. 3

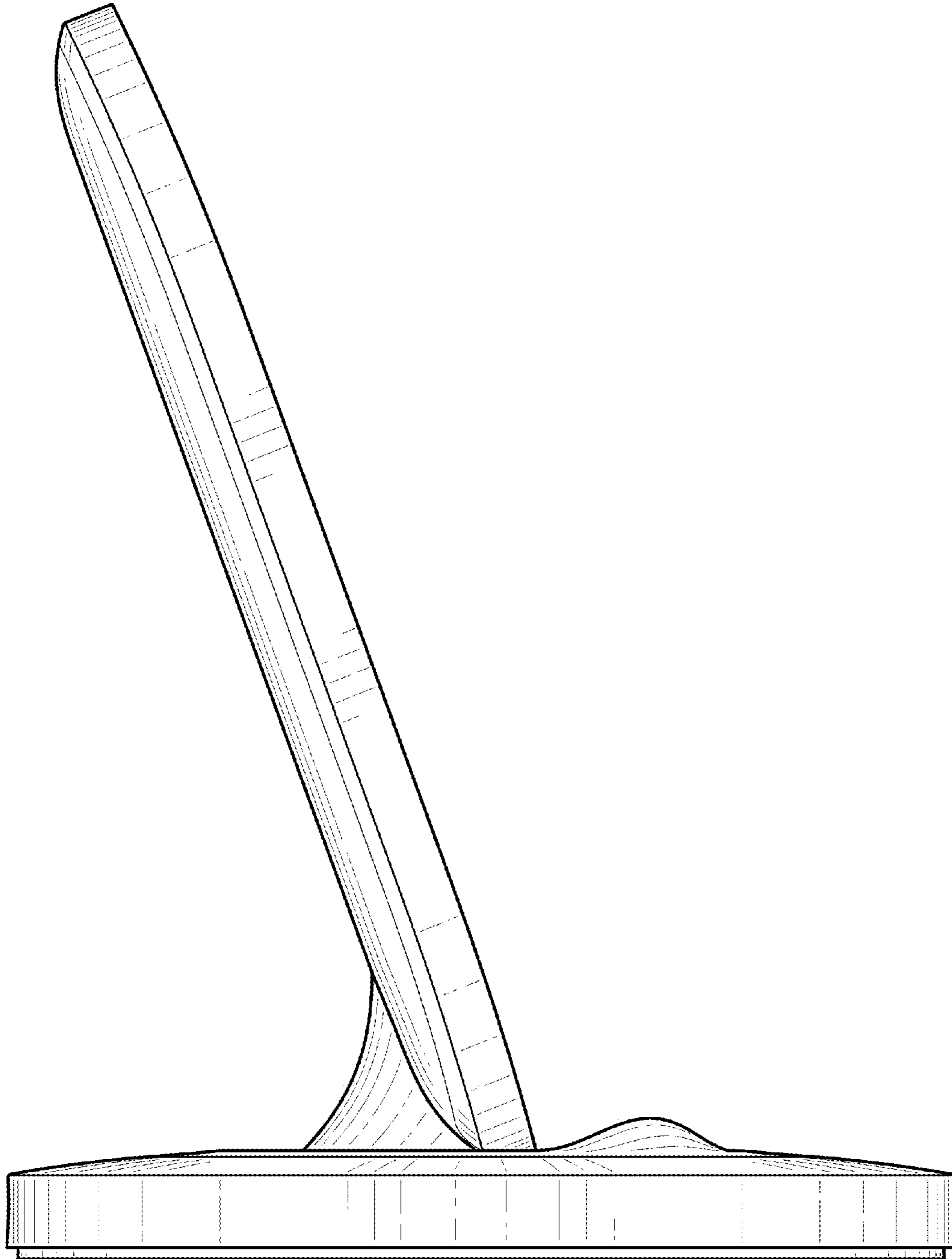

FIG. 4

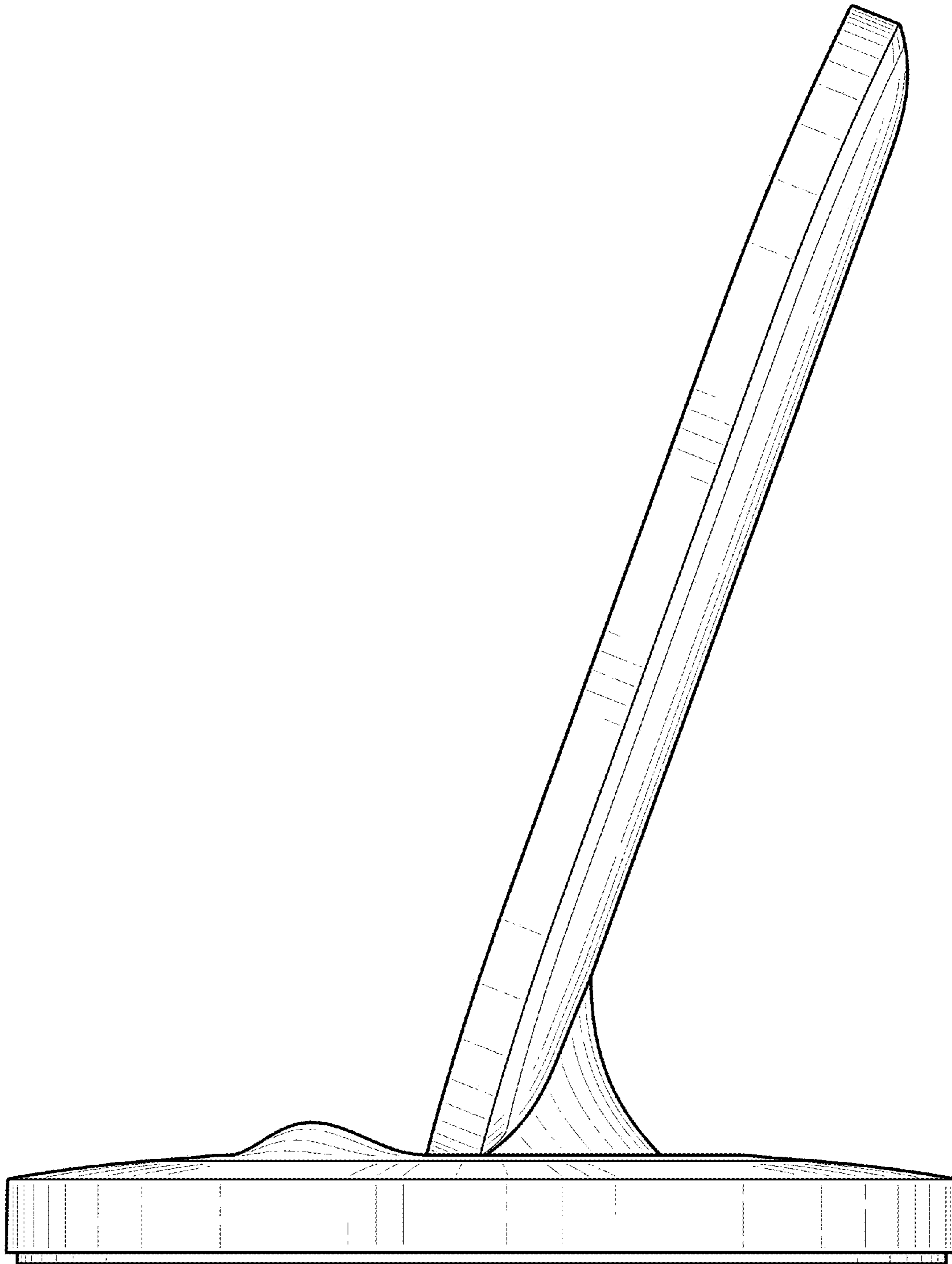

FIG. 5

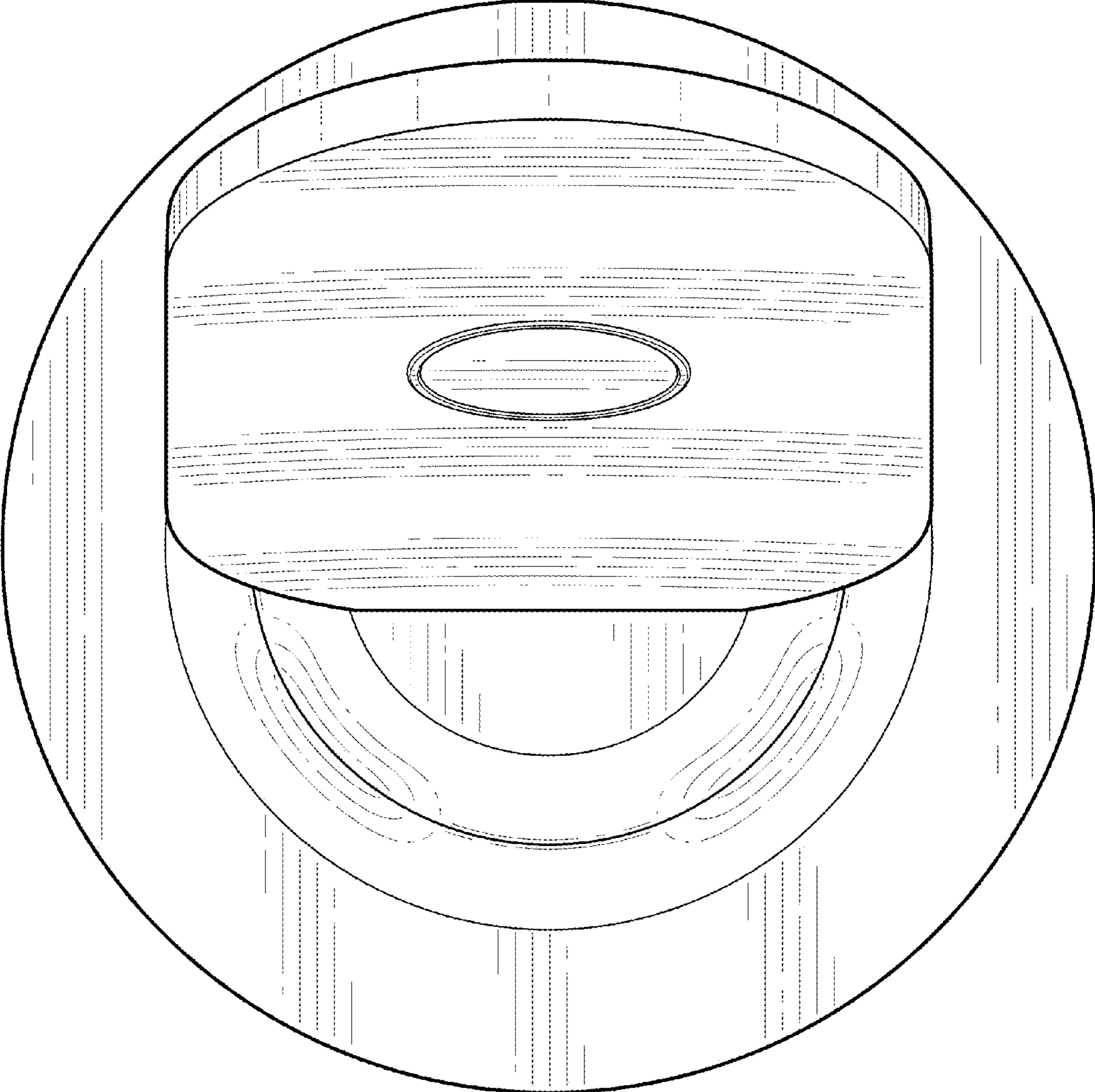

FIG. 6

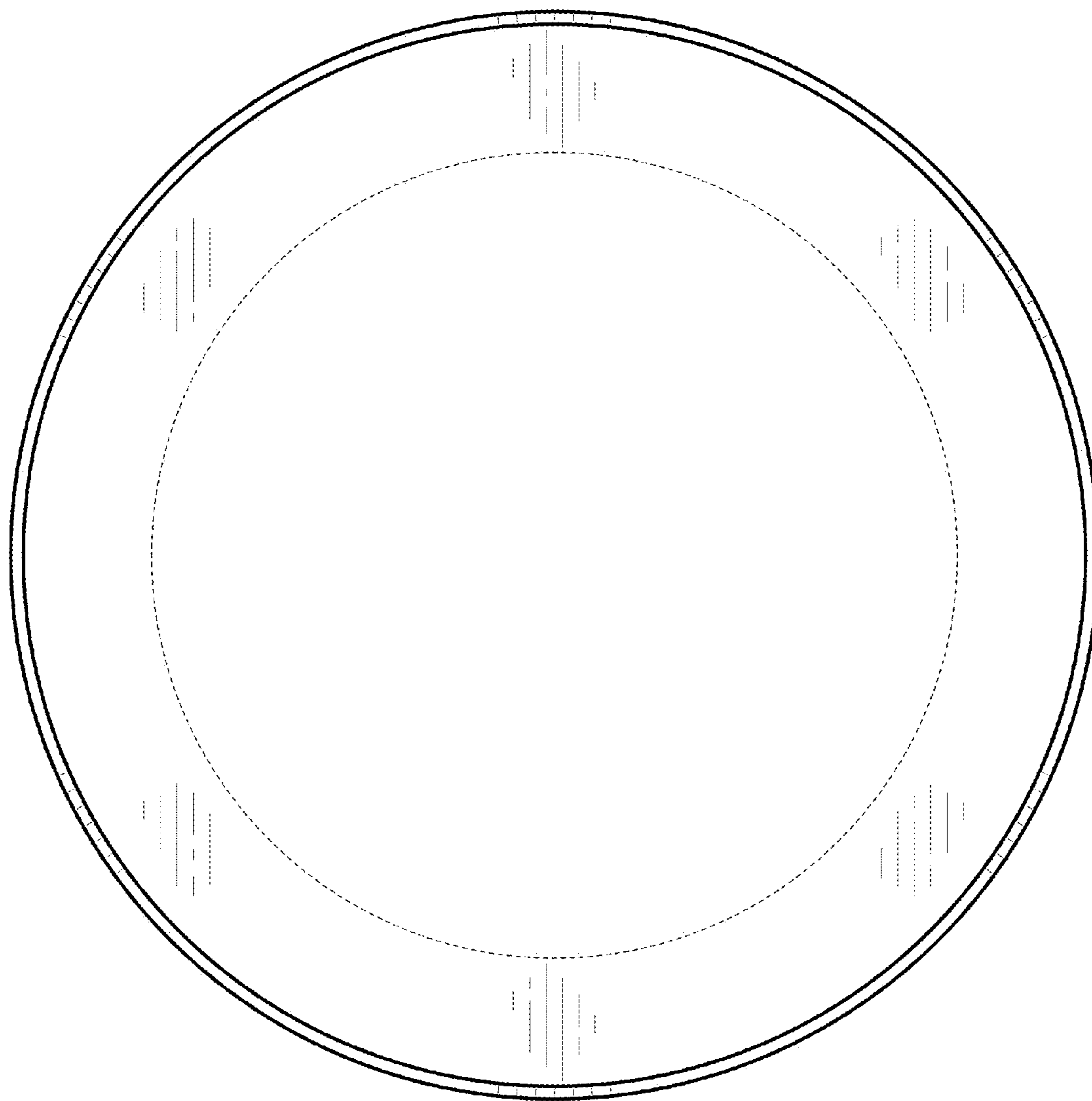

FIG. 7