



US00D682119S

(12) **United States Design Patent**
Buford

(10) **Patent No.:** **US D682,119 S**

(45) **Date of Patent:** **** May 14, 2013**

(54) **COMMUNION BOX**

(76) Inventor: **Carl A. Buford**, Sanford, FL (US)

(**) Term: **14 Years**

(21) Appl. No.: **29/409,663**

(22) Filed: **Dec. 27, 2011**

(51) **LOC (9) Cl.** **09-03**

(52) **U.S. Cl.**
USPC **D9/721**

(58) **Field of Classification Search** D9/414,
D9/418, 420, 421, 423, 704, 711, 715, 718,
D9/721, 722, 756, 759; 206/215, 218, 223,
206/256, 322, 323, 324, 325, 497, 521, 575,
206/576, 583, 733; 220/3.8; 229/4.5, 103.2,
229/103.3, 162.1, 193; D3/202, 205, 208,
D3/230, 272, 274

See application file for complete search history.

(56) **References Cited**

U.S. PATENT DOCUMENTS

D23,901 S	12/1894	Howe	
3,826,420 A *	7/1974	Bamburg et al.	229/102
D242,202 S	11/1976	Davis	
D254,600 S *	4/1980	Jones, III	D3/274
D264,810 S	6/1982	Voltmann	
D275,833 S *	10/1984	Malpass	D3/203.3
D279,865 S	7/1985	McKee	
D284,419 S	6/1986	Stroud	
D315,297 S	3/1991	Campbell	
D317,255 S	6/1991	Turk	
5,025,920 A *	6/1991	Walsh et al.	206/223
D333,487 S *	2/1993	Papp	D19/75
5,251,760 A *	10/1993	Smith et al.	206/583
D401,734 S	11/1998	Monk	
D417,330 S	11/1999	Kim	

D505,320 S *	5/2005	Gattefosse et al.	D9/732
D511,681 S *	11/2005	Cogley et al.	D9/416
D513,596 S *	1/2006	Hamblin et al.	D9/756
D522,376 S *	6/2006	Hales	D9/658
D569,268 S	5/2008	Markowicz et al.	
D589,363 S *	3/2009	Vandecasteele et al.	D9/721
2004/0253346 A1 *	12/2004	Amato	426/89

* cited by examiner

Primary Examiner — Derrick Holland

Assistant Examiner — Lauren Calve

(74) *Attorney, Agent, or Firm* — QuickPatents; Kevin Prince

(57) **CLAIM**

I claim the ornamental design for a communion box, as shown and described.

DESCRIPTION

FIG. 1 is a top plan view of a communion box, showing my new design in a flat configuration with a plurality of communion wine and wafer cups and a cup tray omitted for clarity of illustration, the bottom plan view being a mirror image thereof;

FIG. 2 is a perspective view thereof, the box illustrated in an assembled and open configuration, one of the plurality of communion wine and wafer cups shown exploded away therefrom;

FIG. 3 is a rear elevational view of FIG. 2;

FIG. 4 is an unexploded front elevational view of FIG. 2;

FIG. 5 is a right-side elevational view of FIG. 4, the left-side elevational view being a mirror image thereof;

FIG. 6 is a top plan view of FIG. 4;

FIG. 7 is a bottom plan view of FIG. 4;

FIG. 8 is a top perspective view thereof, the box illustrated in a closed configuration; and,

FIG. 9 is a bottom perspective view of FIG. 9.

1 Claim, 3 Drawing Sheets

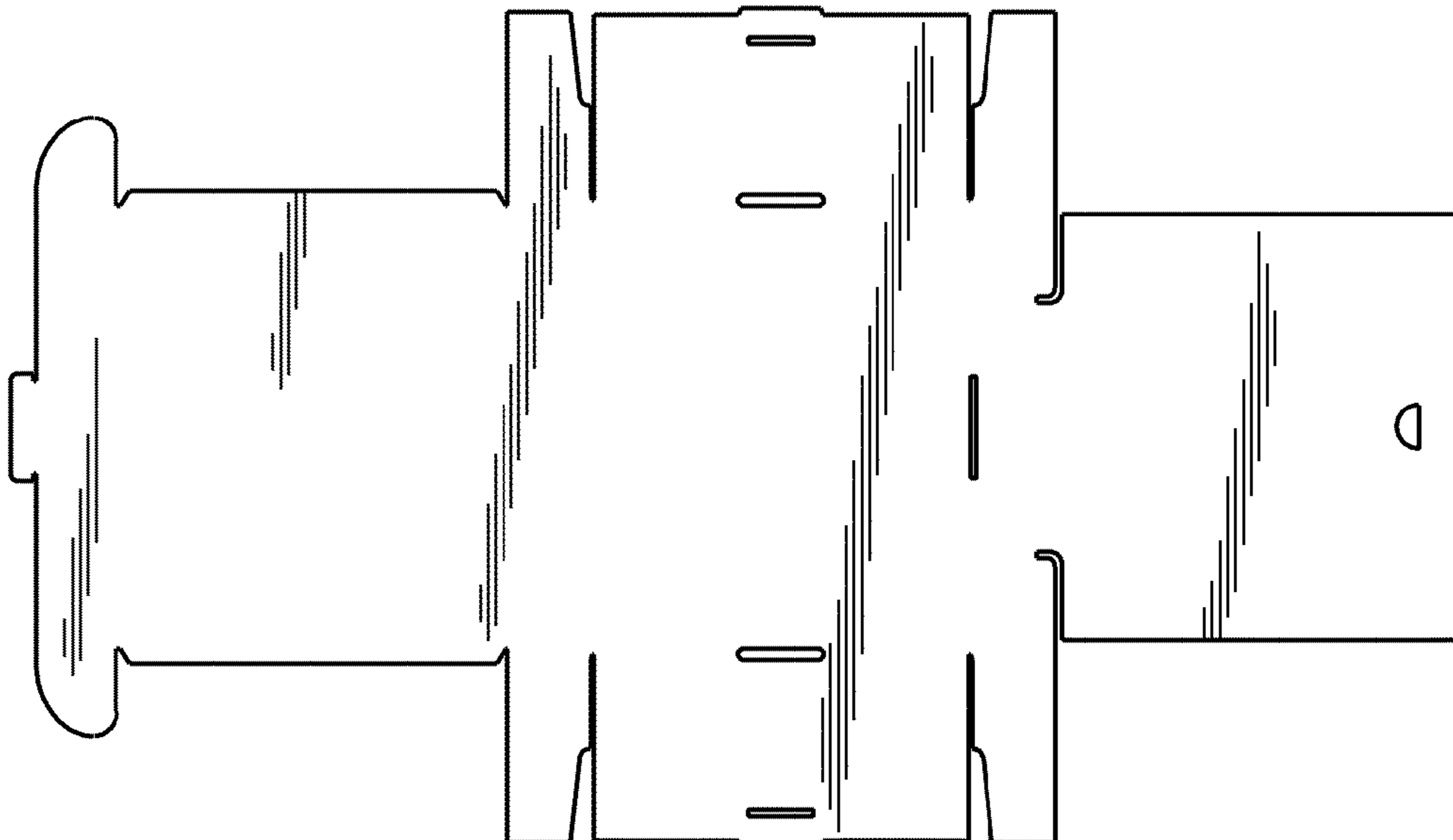

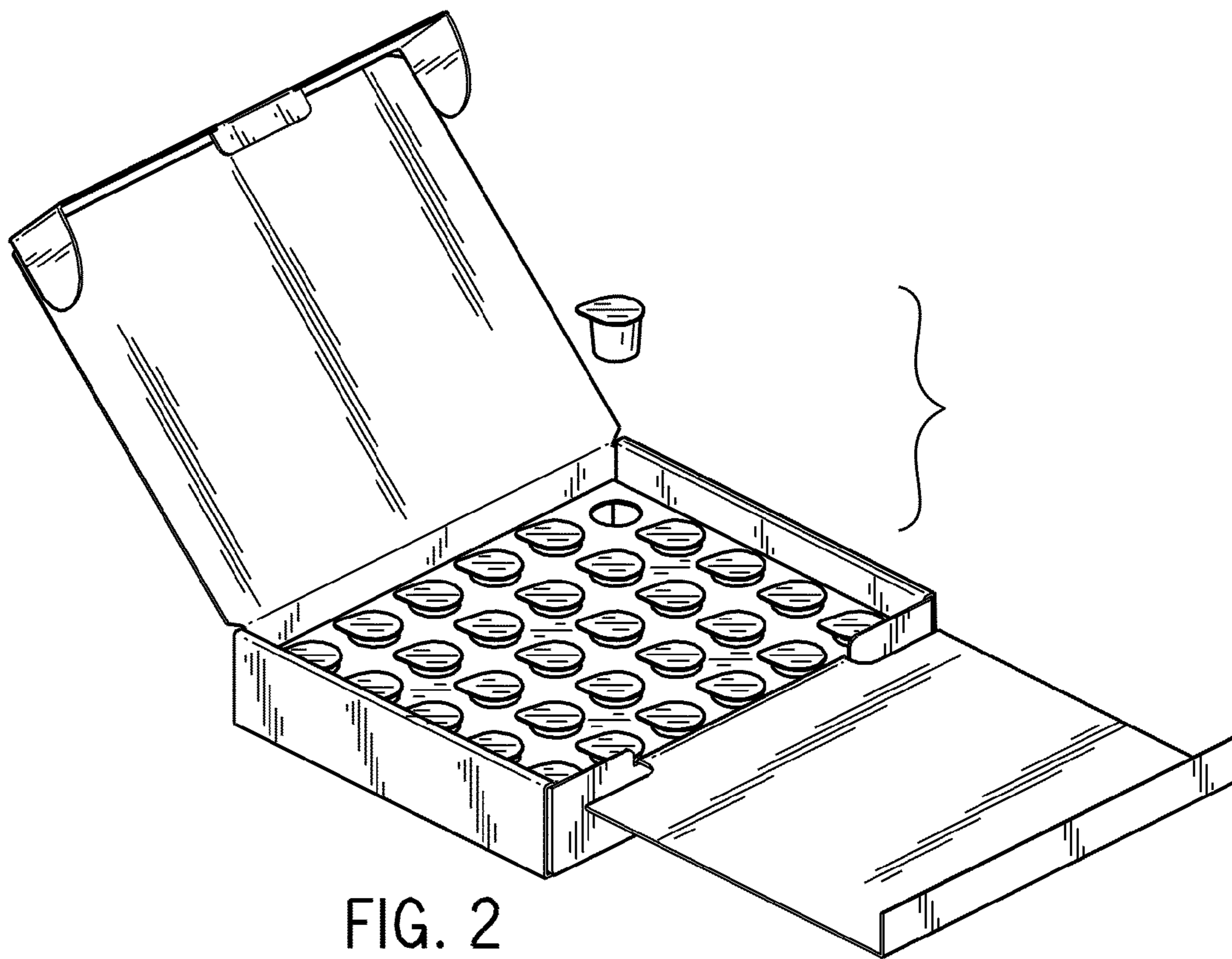
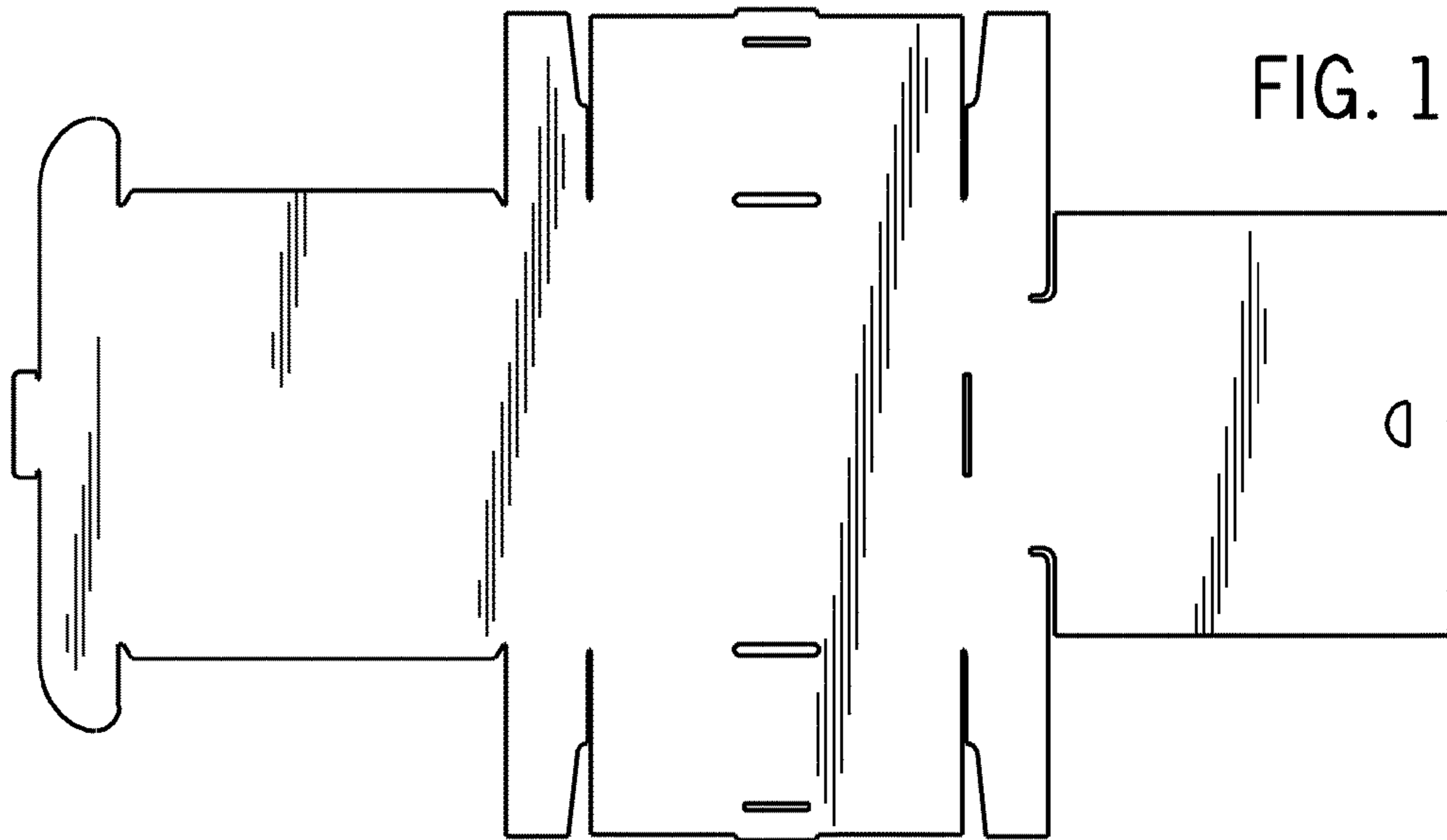

FIG. 2

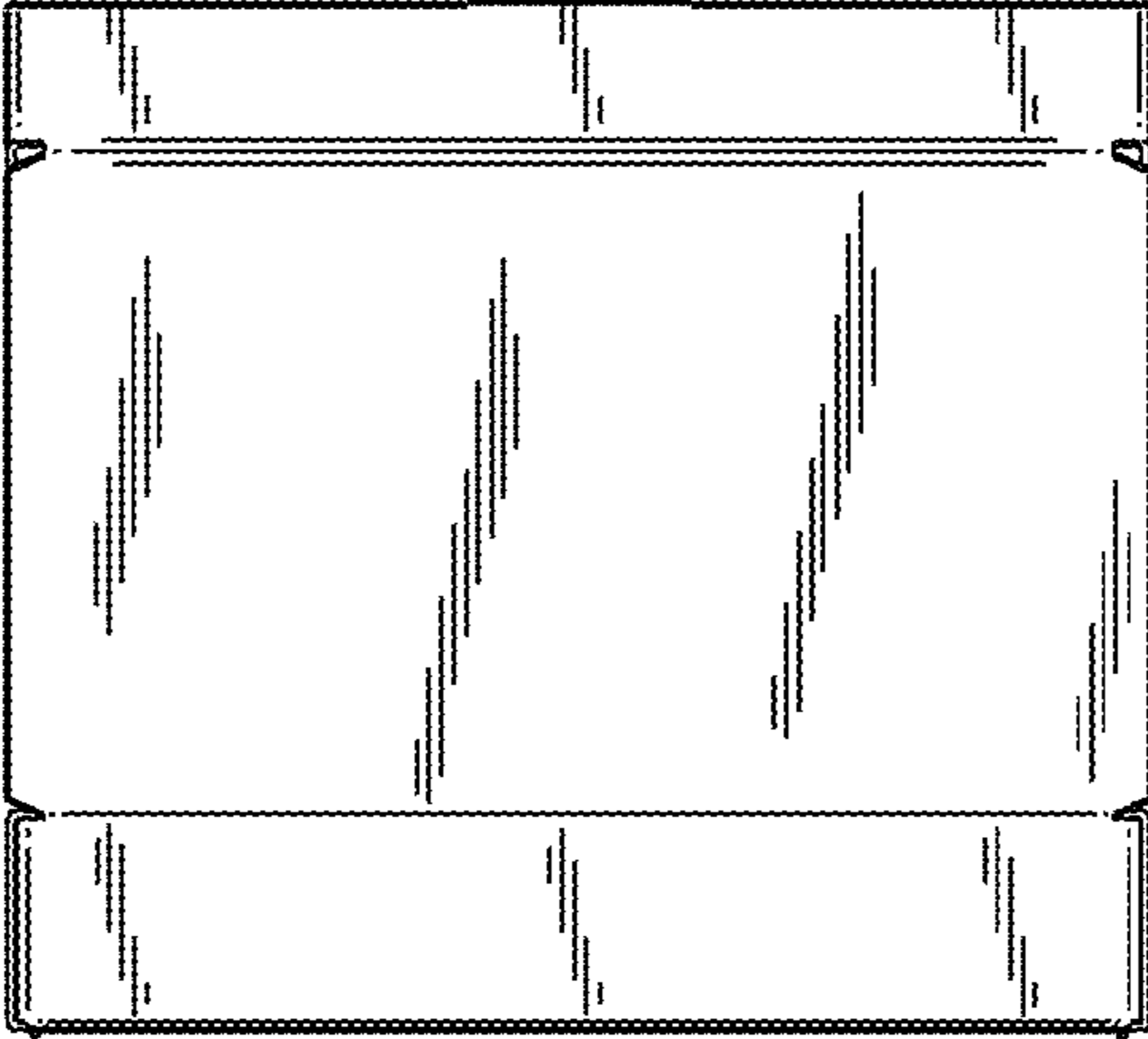

FIG. 3

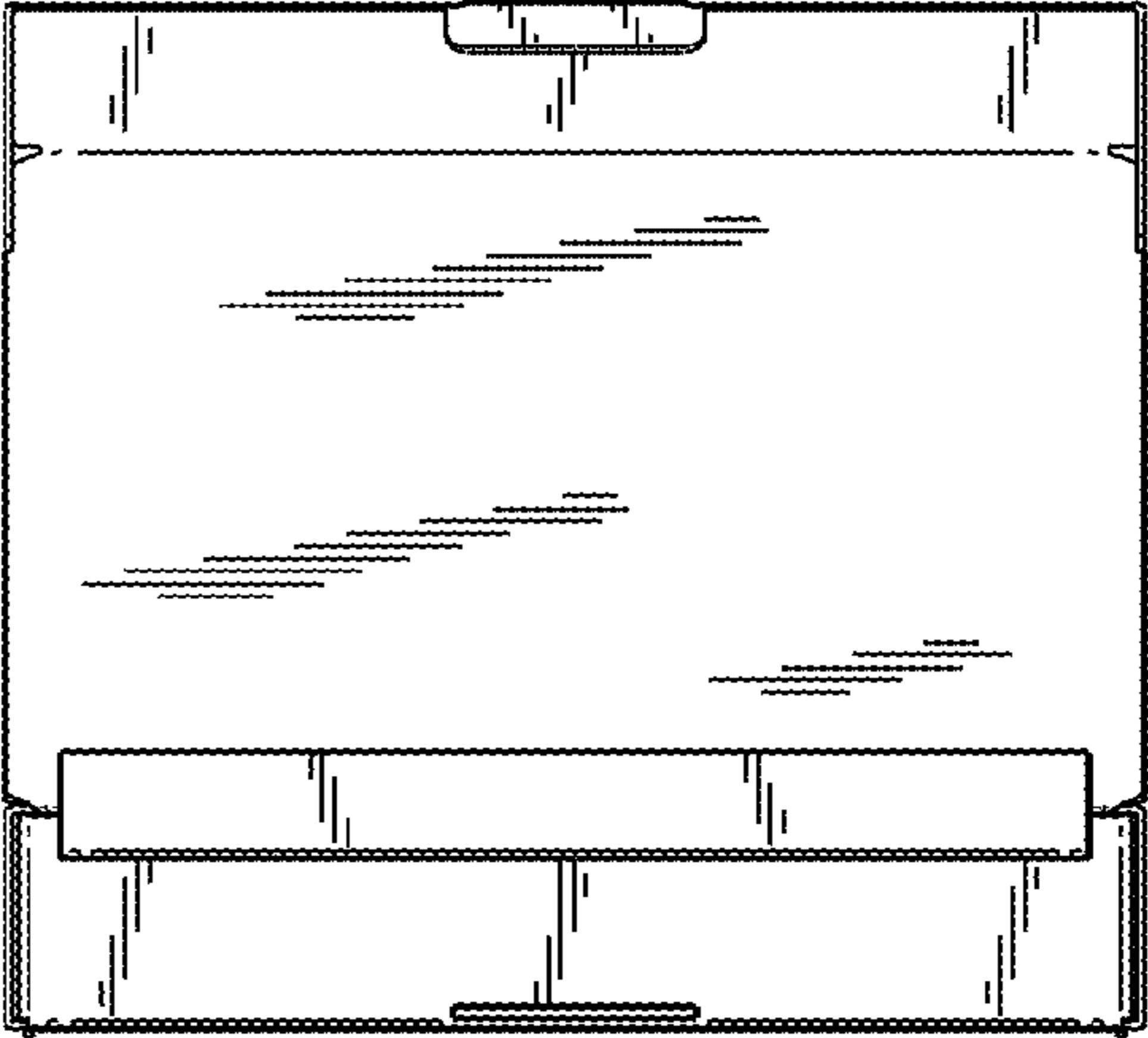

FIG. 4



FIG. 5



FIG. 6

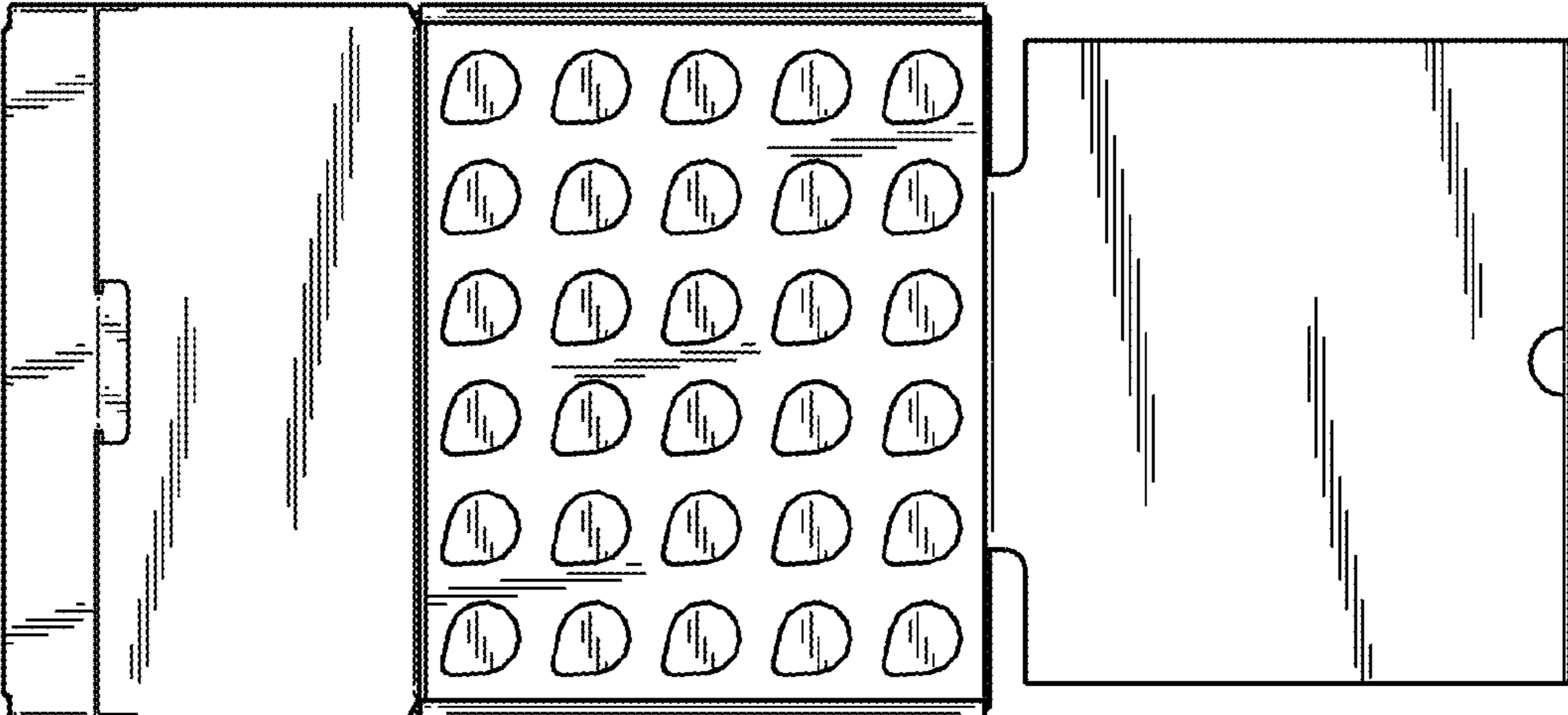

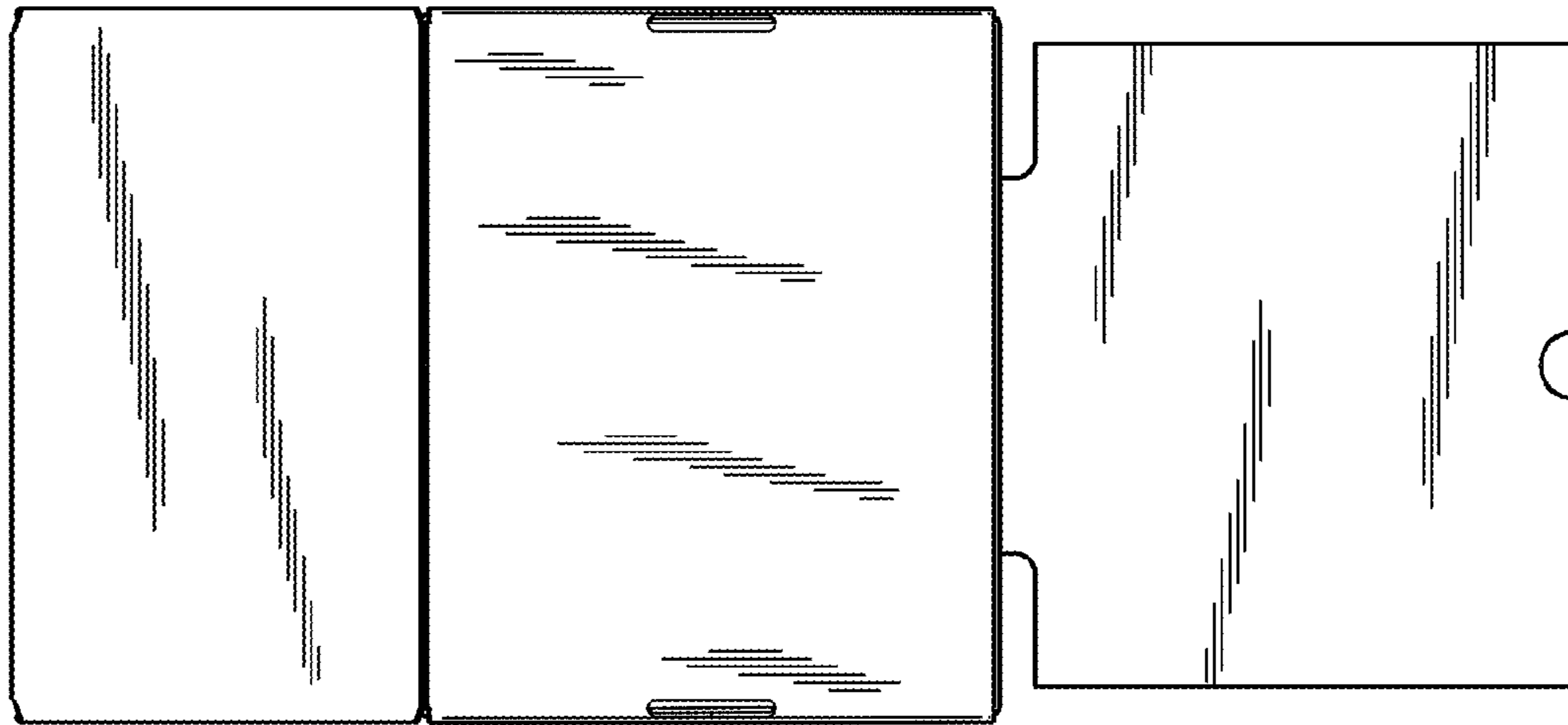

FIG. 7

FIG. 8

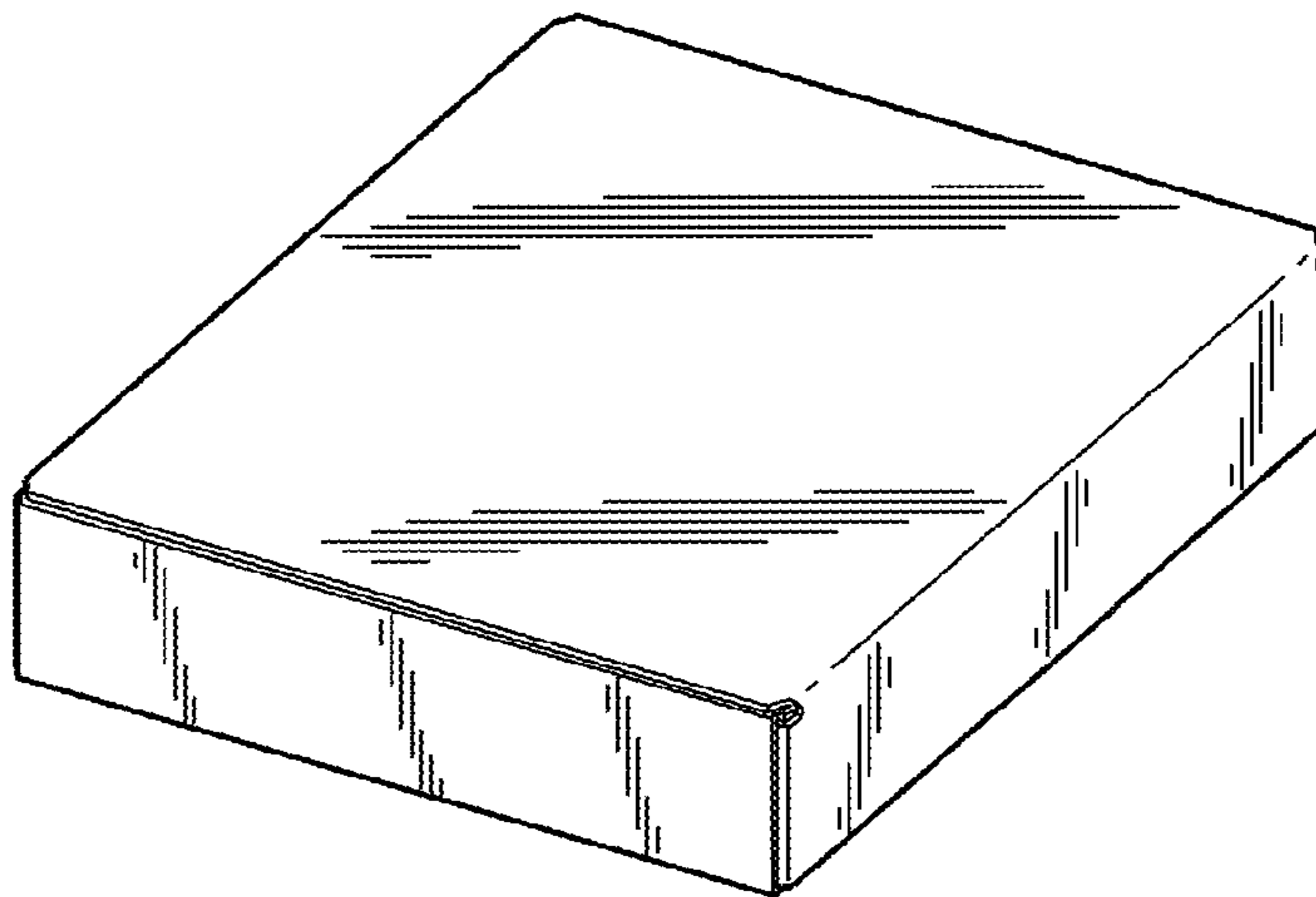

FIG. 9

