



US00D682053S

(12) **United States Design Patent**  
**Boroski**

(10) **Patent No.:** **US D682,053 S**

(45) **Date of Patent:** **\*\* May 14, 2013**

(54) **LUNCH BAG**

(75) Inventor: **Dwayne Boroski**, Lake in the Hills, IL  
(US)

(73) Assignee: **Thermos L.L.C.**, Schaumburg, IL (US)

(\*\*) Term: **14 Years**

(21) Appl. No.: **29/416,518**

(22) Filed: **Mar. 23, 2012**

(51) **LOC (9) Cl.** ..... **07-99**

(52) **U.S. Cl.**  
USPC ..... **D7/709**

(58) **Field of Classification Search** ..... D7/601-607,  
D7/709, 629; D3/201, 205, 229, 232, 233,  
D3/239-243, 245, 246, 276, 283, 287, 289-293,  
D3/299; 62/457.1-457.9, 371, 372; 150/100,  
150/103, 104, 106-108, 112, 118; 220/195.03,  
220/592.03, 915.1, 915.2

See application file for complete search history.

(56) **References Cited**

**U.S. PATENT DOCUMENTS**

D281,546 S \* 12/1985 Bradshaw ..... D7/607  
D324,977 S \* 3/1992 Rosson ..... D7/709  
D406,457 S \* 3/1999 De Baschmakoff ..... D3/243  
D421,371 S \* 3/2000 Fair ..... D7/709

D610,801 S \* 3/2010 Romero et al. .... D3/232  
D611,705 S \* 3/2010 Romero et al. .... D3/232  
D619,432 S \* 7/2010 LaBonte ..... D7/709

**OTHER PUBLICATIONS**

Web page showing ebags handbag, printed Nov. 10, 2011.  
5 pages showing handbags on ebags web site, date unknown.

\* cited by examiner

*Primary Examiner* — Terry Wallace

(74) *Attorney, Agent, or Firm* — Schiff Hardin LLP

(57) **CLAIM**

The ornamental design of the lunch bag, as shown and described.

**DESCRIPTION**

FIG. 1 is a perspective view taken from the upper, front, right-hand side of the lunch bag of the present invention; FIG. 2 is a perspective view taken from the lower, back, left-hand side of the lunch bag of FIG. 1; FIG. 3 is a side elevational view of the left side of the lunch bag of FIG. 1; FIG. 4 is a front elevational view of the lunch bag of FIG. 1; FIG. 5 is a side elevational view of the right side of the lunch bag of FIG. 1; FIG. 6 is a rear elevational view of the lunch bag of FIG. 1; FIG. 7 is a top plan view of the lunch bag of FIG. 1; and, FIG. 8 is a bottom plan view of the lunch bag of FIG. 1.

**1 Claim, 8 Drawing Sheets**

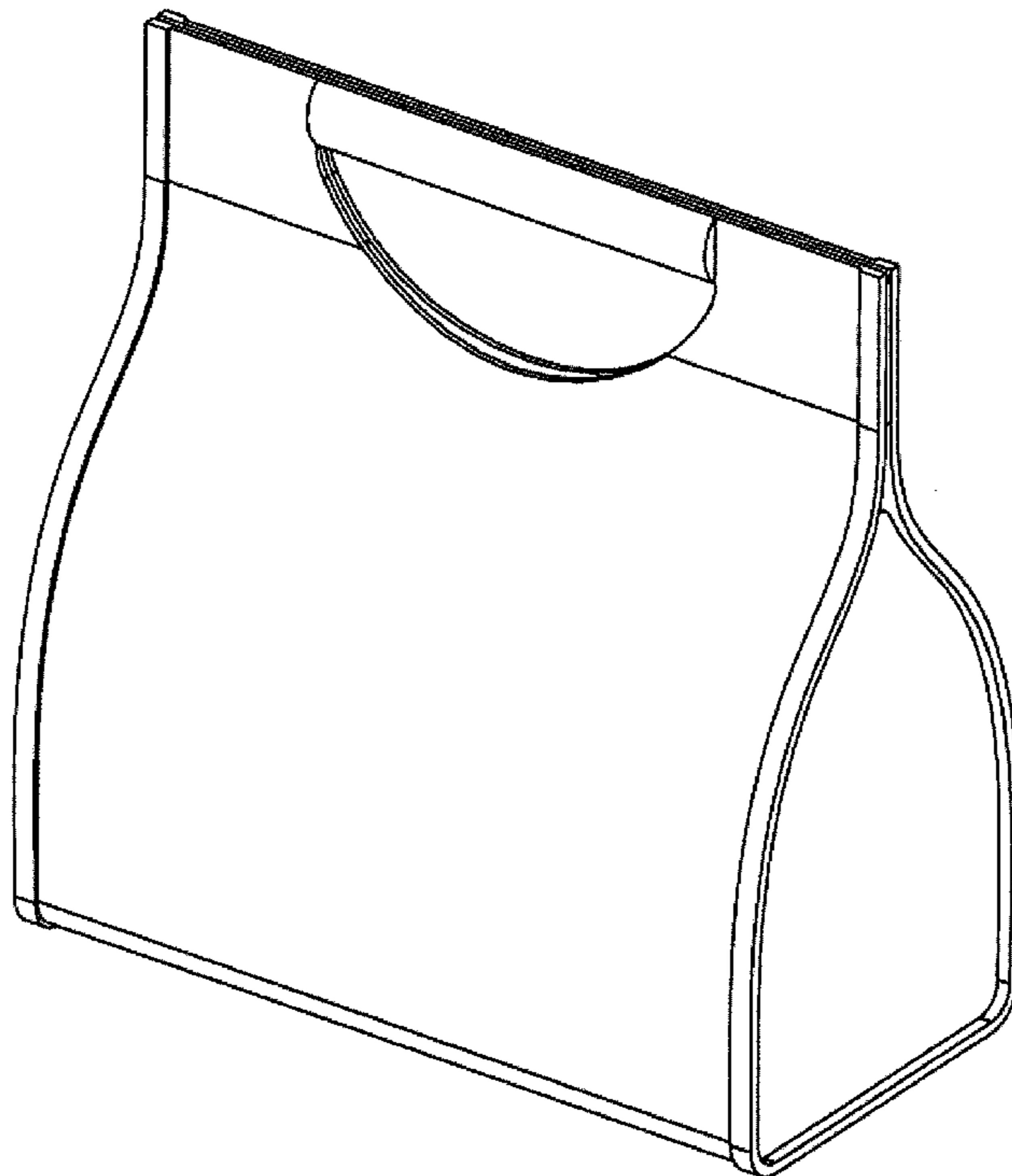

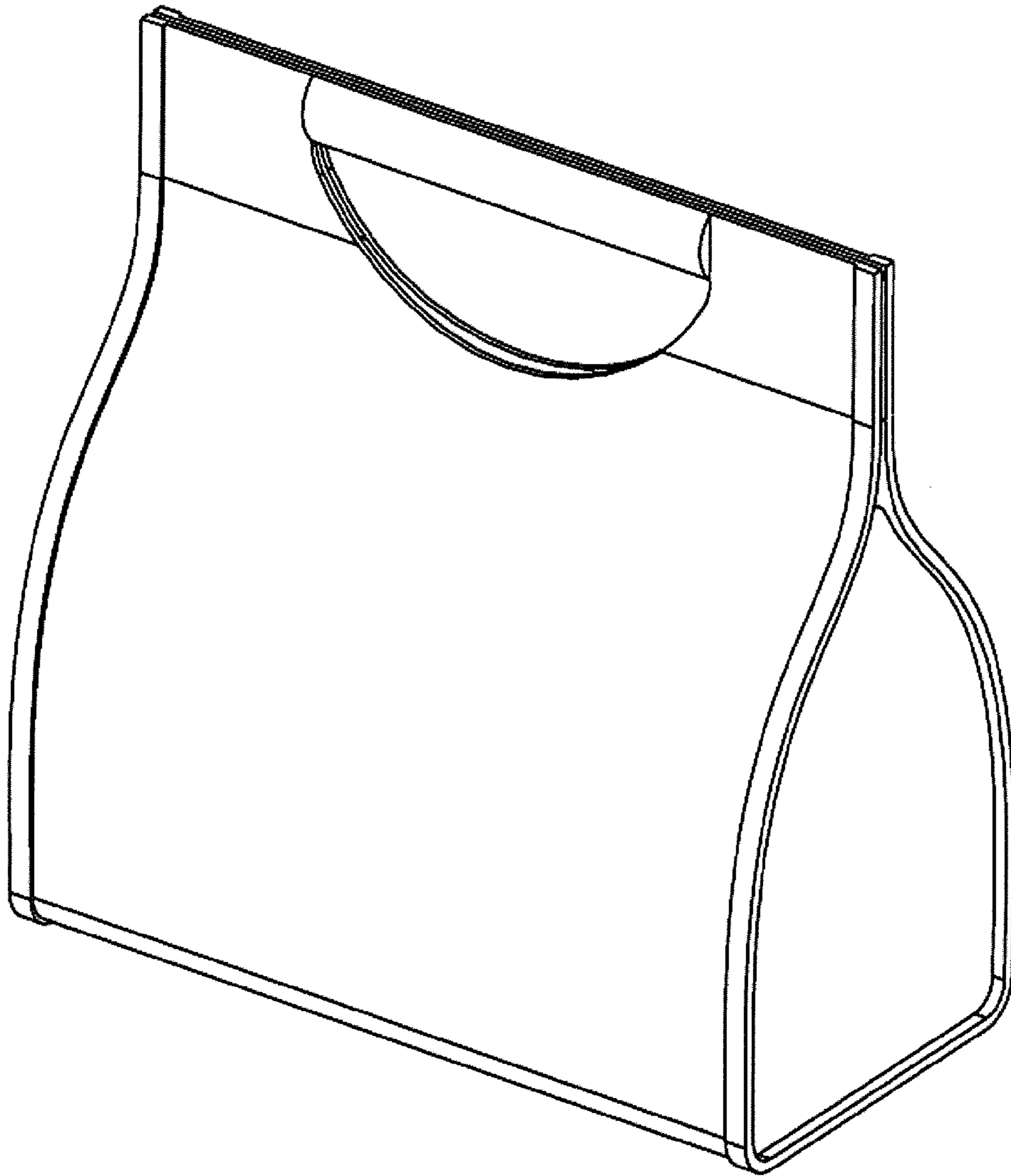

Figure 1

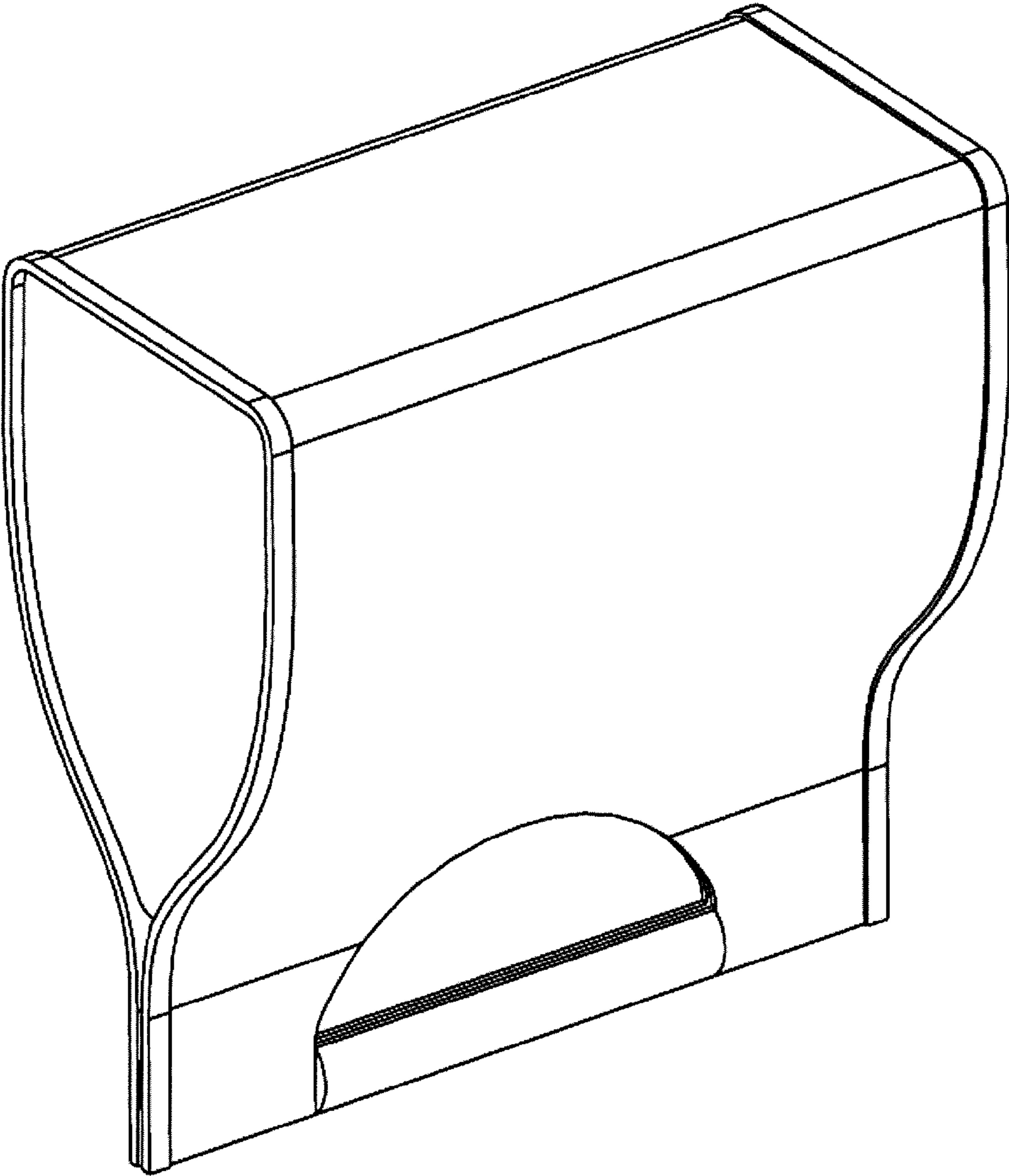

Figure 2

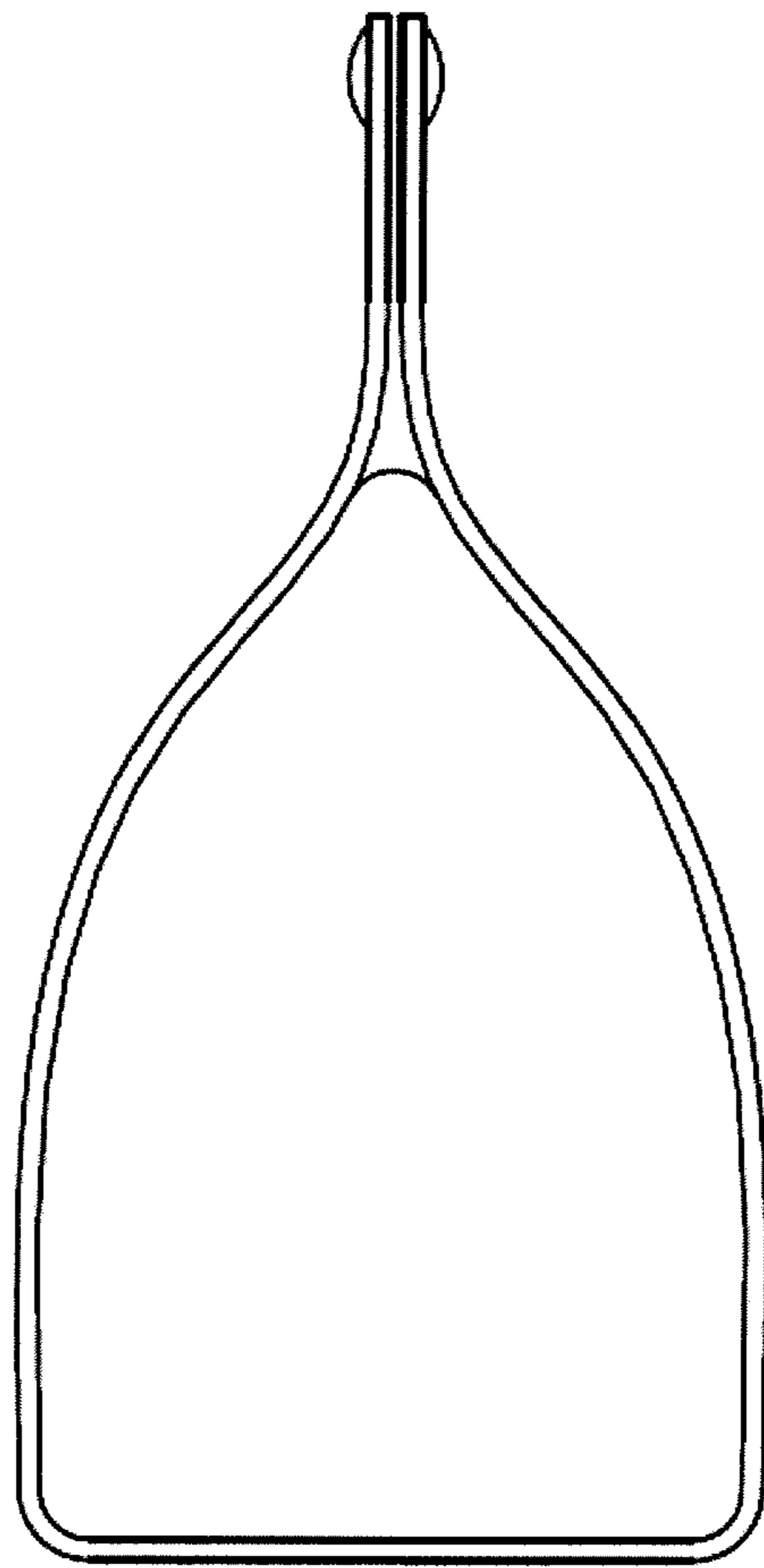

Figure 3

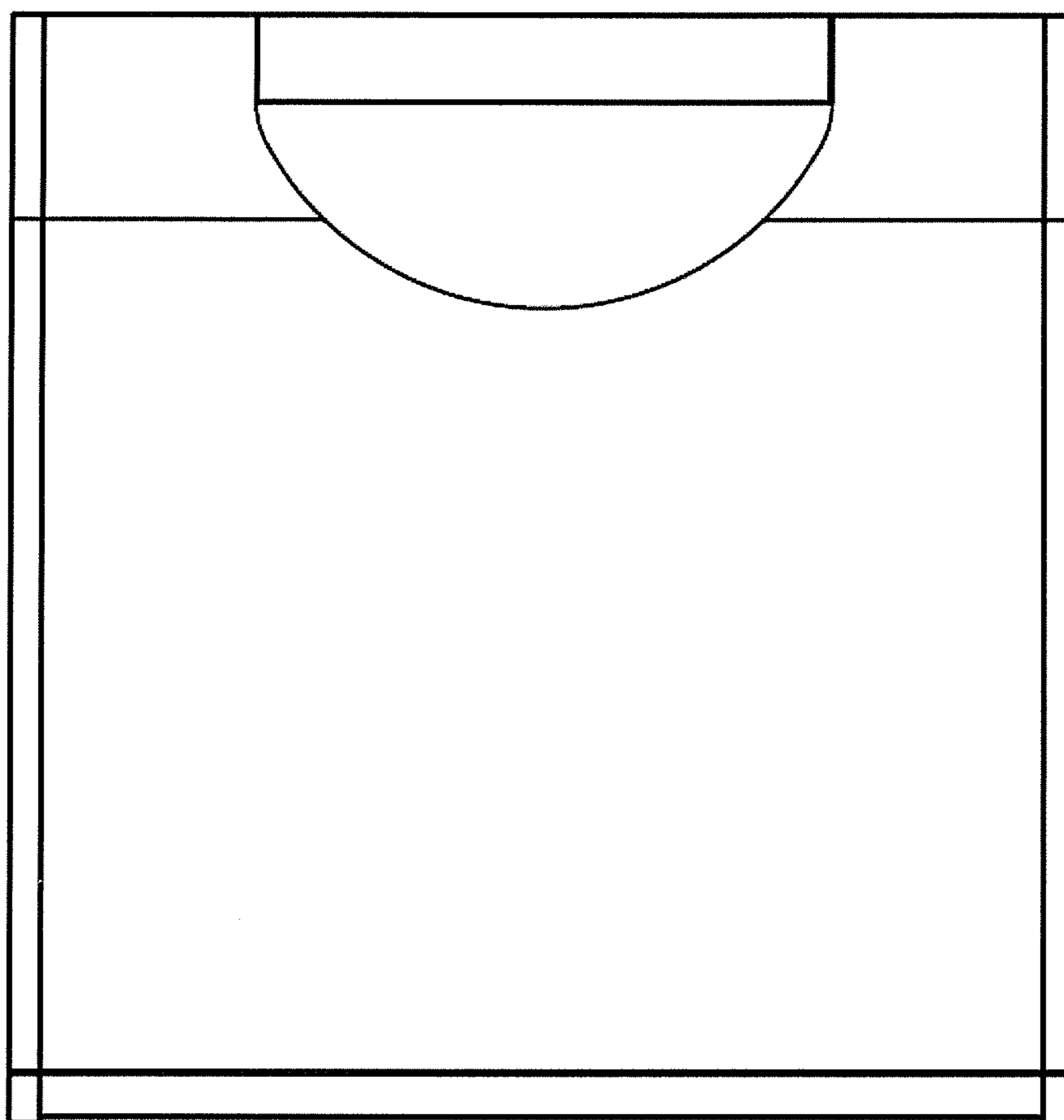

Figure 4

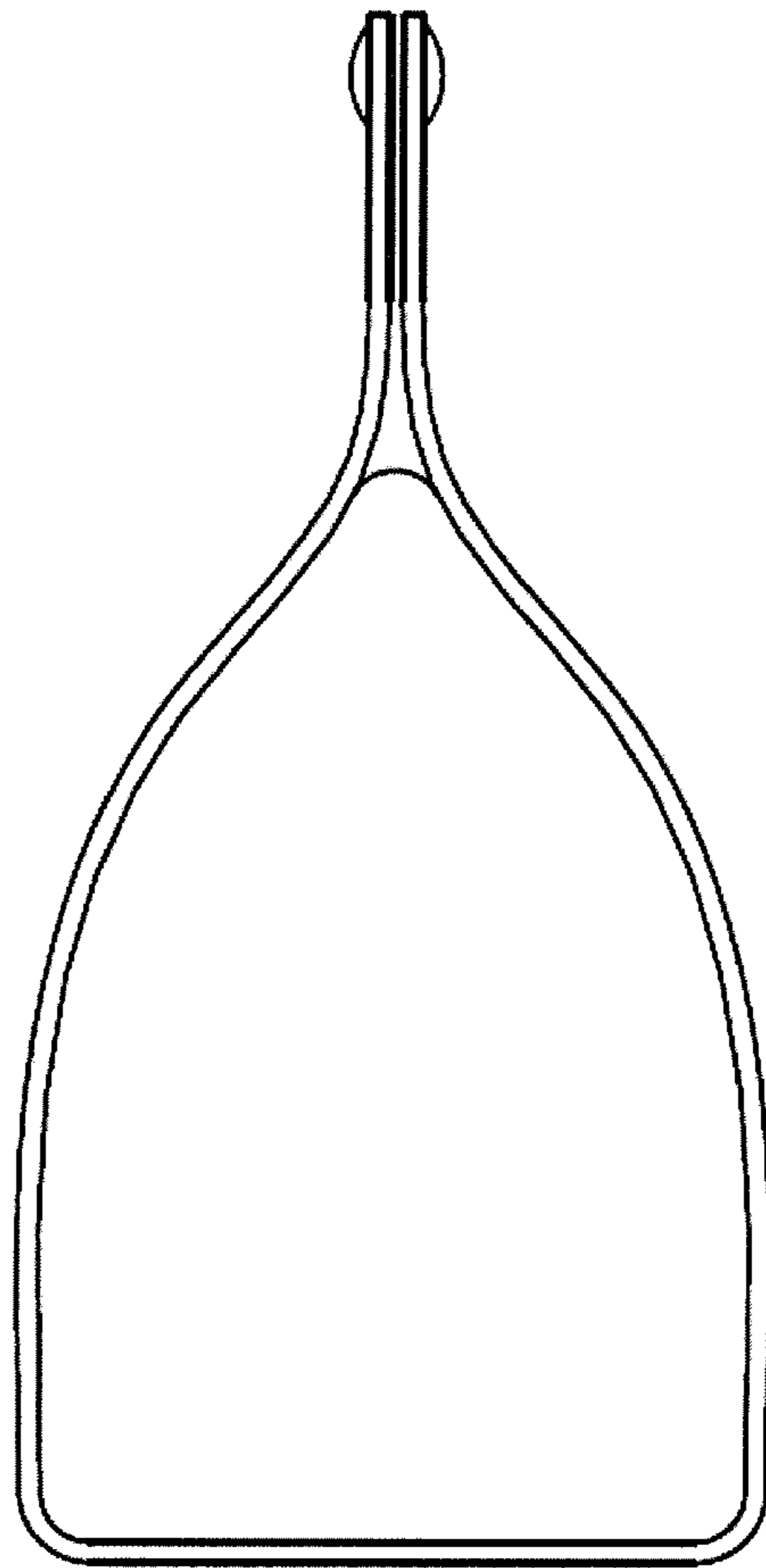

Figure 5

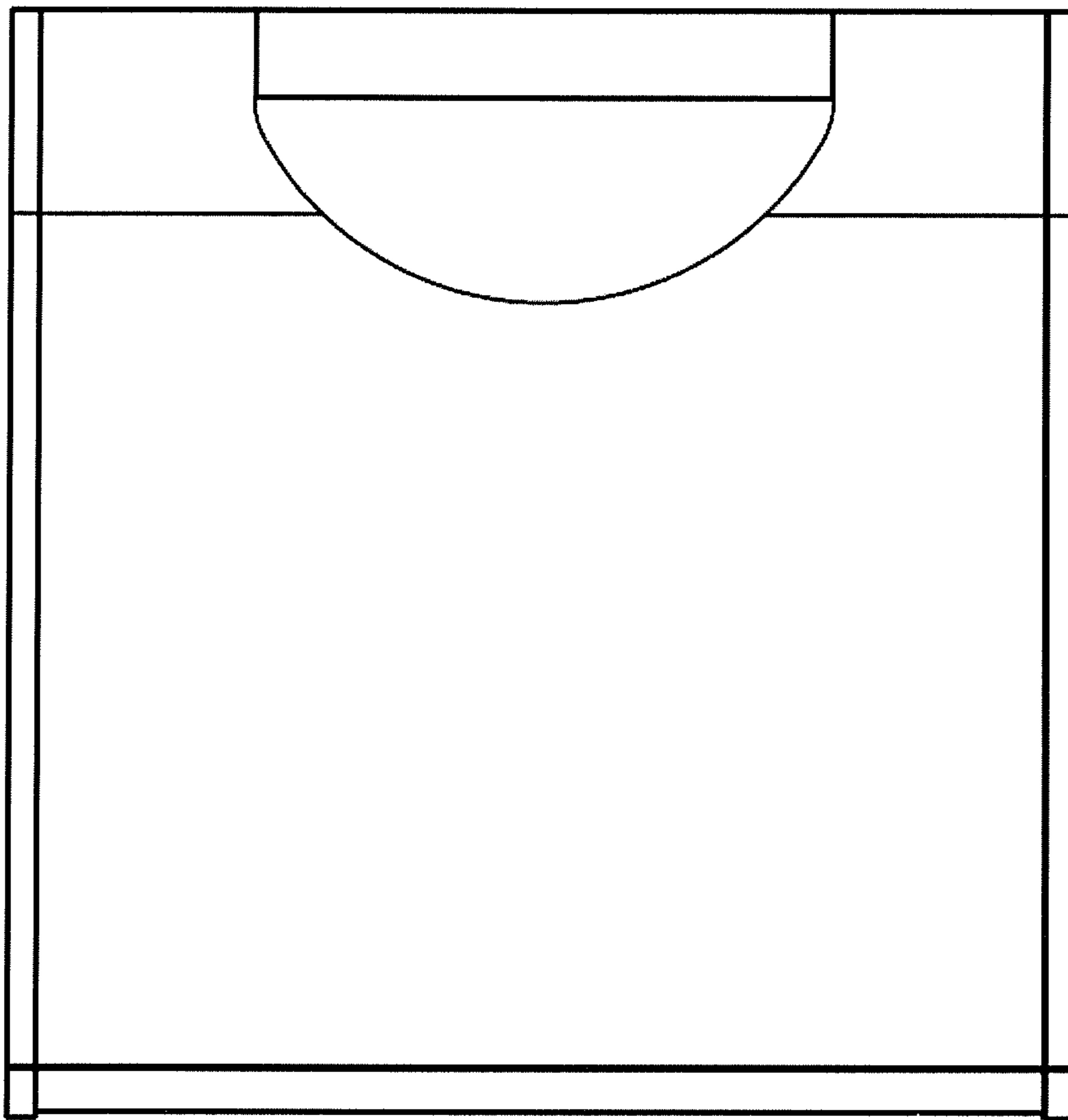

Figure 6

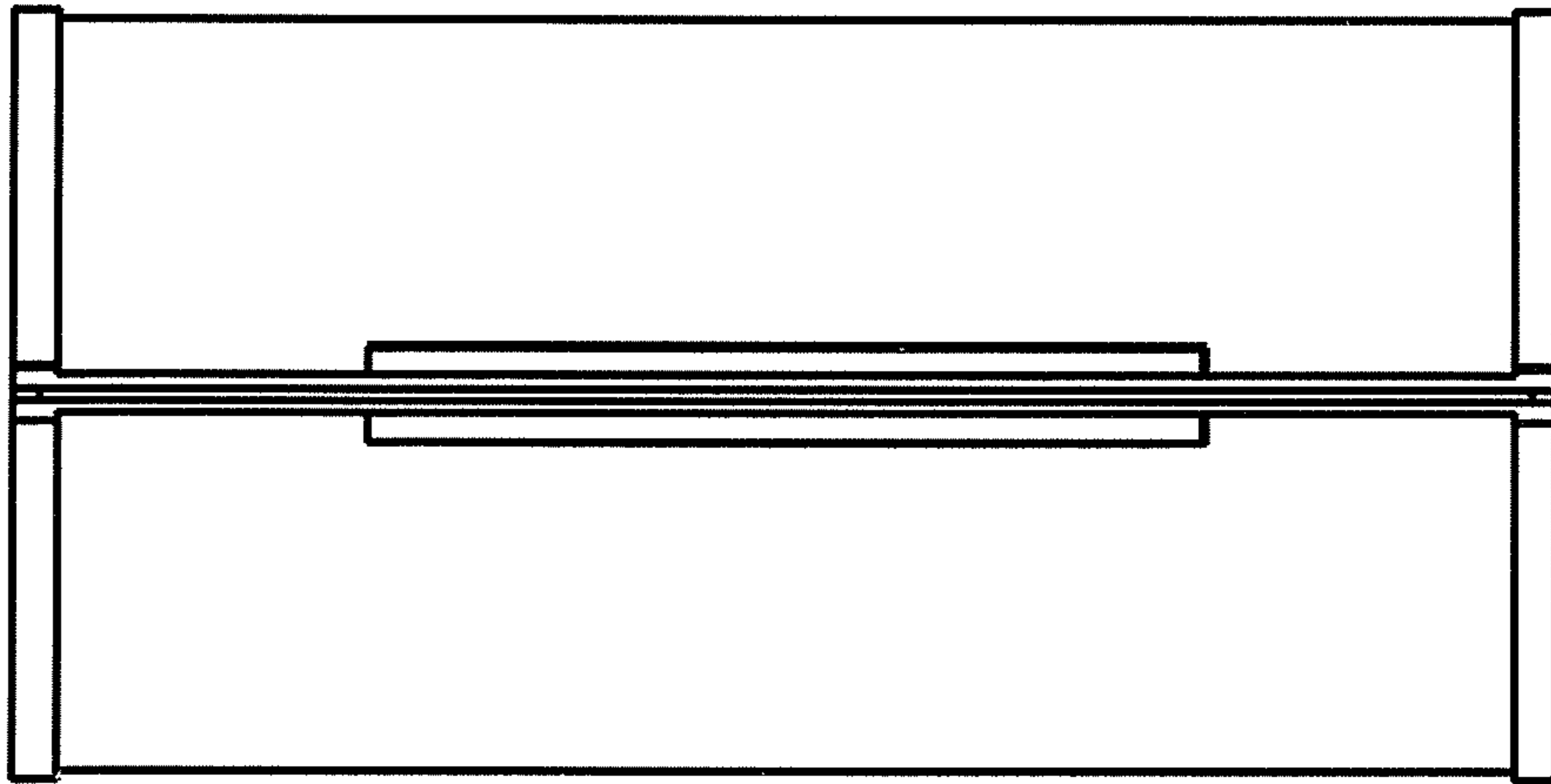

Figure 7



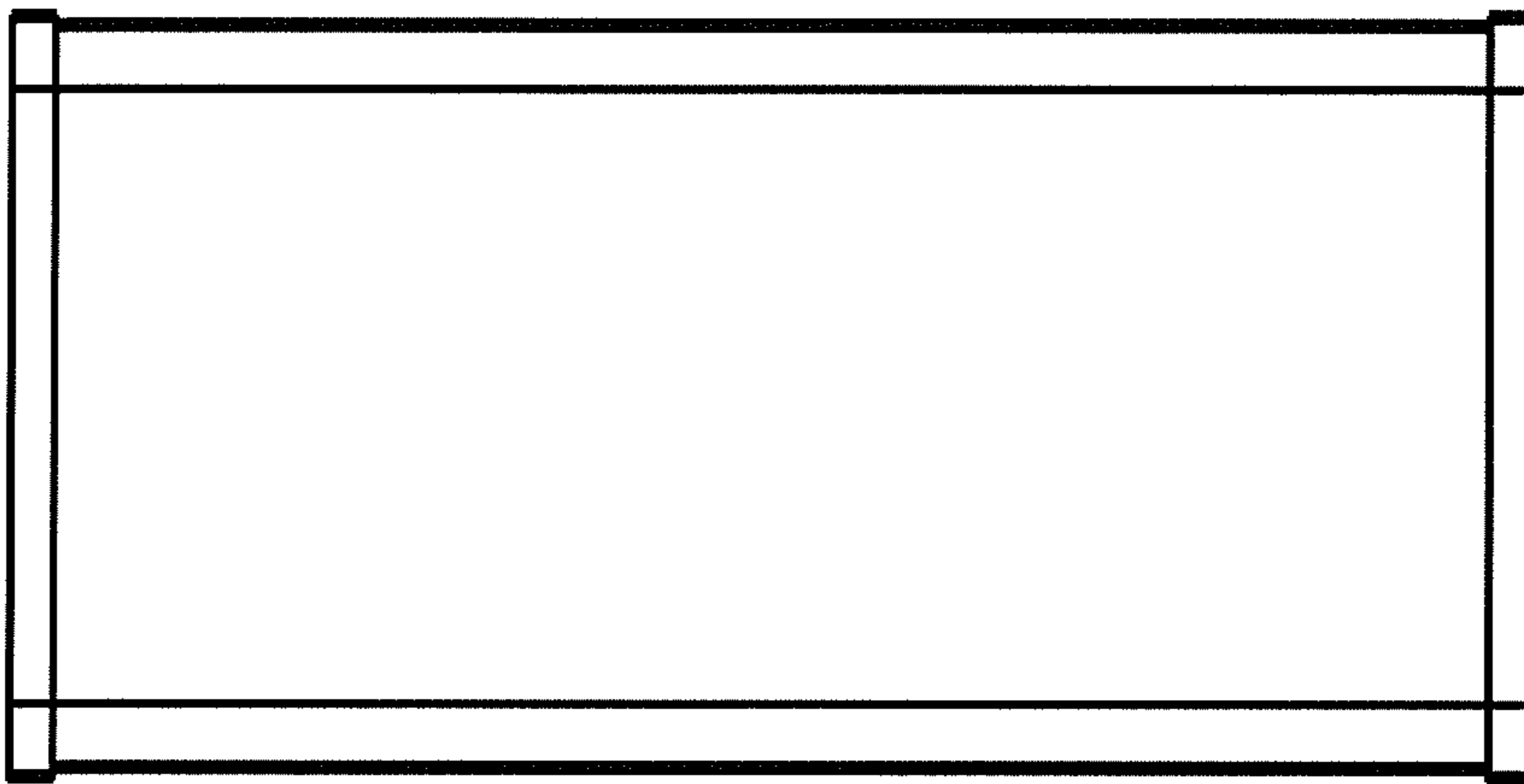

Figure 8