



US00D681845S

(12) **United States Design Patent**  
**Matsuguma**

(10) **Patent No.:** **US D681,845 S**

(45) **Date of Patent:** **\*\* May 7, 2013**

(54) **TEMPERATURE AND HUMIDITY CHAMBER**

D430,304 S \* 8/2000 Oonuma et al. .... D24/233  
D607,575 S \* 1/2010 Walsh ..... D24/216

(75) Inventor: **Osamu Matsuguma**, Osaka (JP)

\* cited by examiner

(73) Assignee: **Espec Corporation** (JP)

*Primary Examiner* — Wan Laymon

(\*\*) Term: **14 Years**

(74) *Attorney, Agent, or Firm* — Banner & Witcoff, Ltd.

(21) Appl. No.: **29/414,513**

(57) **CLAIM**

The ornamental design for a temperature and humidity chamber, as shown and described.

(22) Filed: **Feb. 29, 2012**

**DESCRIPTION**

(30) **Foreign Application Priority Data**

Aug. 31, 2011 (JP) ..... 2011-019710  
Aug. 31, 2011 (JP) ..... 2011-019711

FIG. 1 is a perspective view of the front, top and left side of temperature and humidity chamber according to a first embodiment showing my new design;

(51) **LOC (9) Cl.** ..... **24-02**

FIG. 2 is a front view thereof;

(52) **U.S. Cl.**  
USPC ..... **D24/232**

FIG. 3 is a rear view thereof;

(58) **Field of Classification Search** ..... D24/232,  
D24/107, 169, 231, 233, 216; D10/46, 81;  
312/236; D15/144.1; 422/62-63; 62/92;  
414/586

FIG. 4 is a left side view thereof;

FIG. 5 is a right side view thereof;

FIG. 6 is a top view thereof;

FIG. 7 is a bottom view thereof;

FIG. 8 is a perspective view of the front, top and left side of temperature and humidity chamber according to a second embodiment showing my new design;

FIG. 9 is a front view thereof;

FIG. 10 is a rear view thereof;

FIG. 11 is a left side view thereof;

FIG. 12 is a right side view thereof;

FIG. 13 is a top view thereof; and,

FIG. 14 is a bottom view thereof.

The portions of the article in broken lines are shown for illustrative purposes only and form no part of the claimed design.

See application file for complete search history.

(56) **References Cited**

**U.S. PATENT DOCUMENTS**

D204,131 S \* 3/1966 Williams, Jr. .... D15/144.1  
D297,361 S \* 8/1988 Yamamoto et al. .... D24/232  
D297,564 S \* 9/1988 Yamamoto et al. .... D24/232  
D328,352 S \* 7/1992 Futatsuka ..... D24/232

**1 Claim, 14 Drawing Sheets**

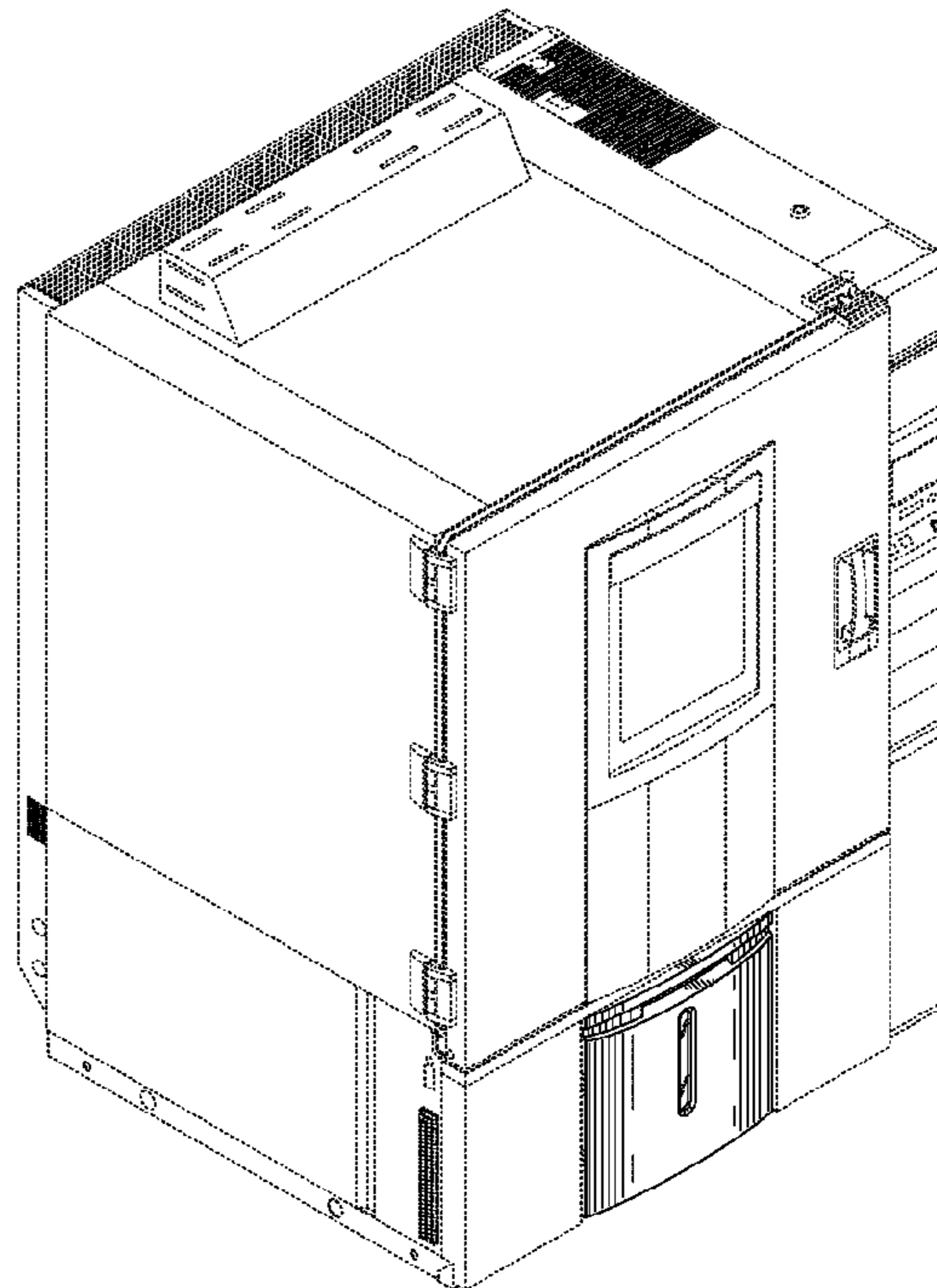
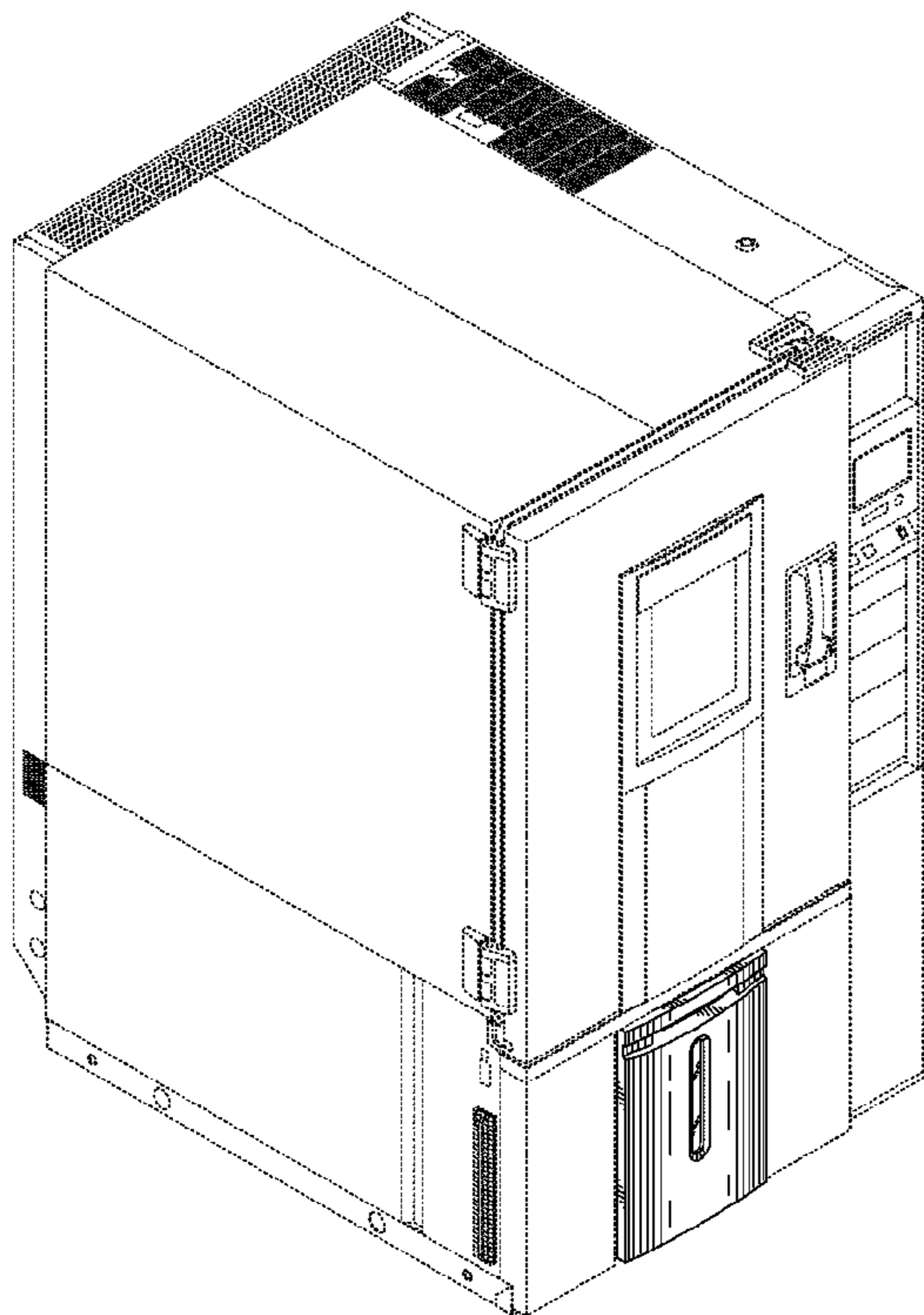

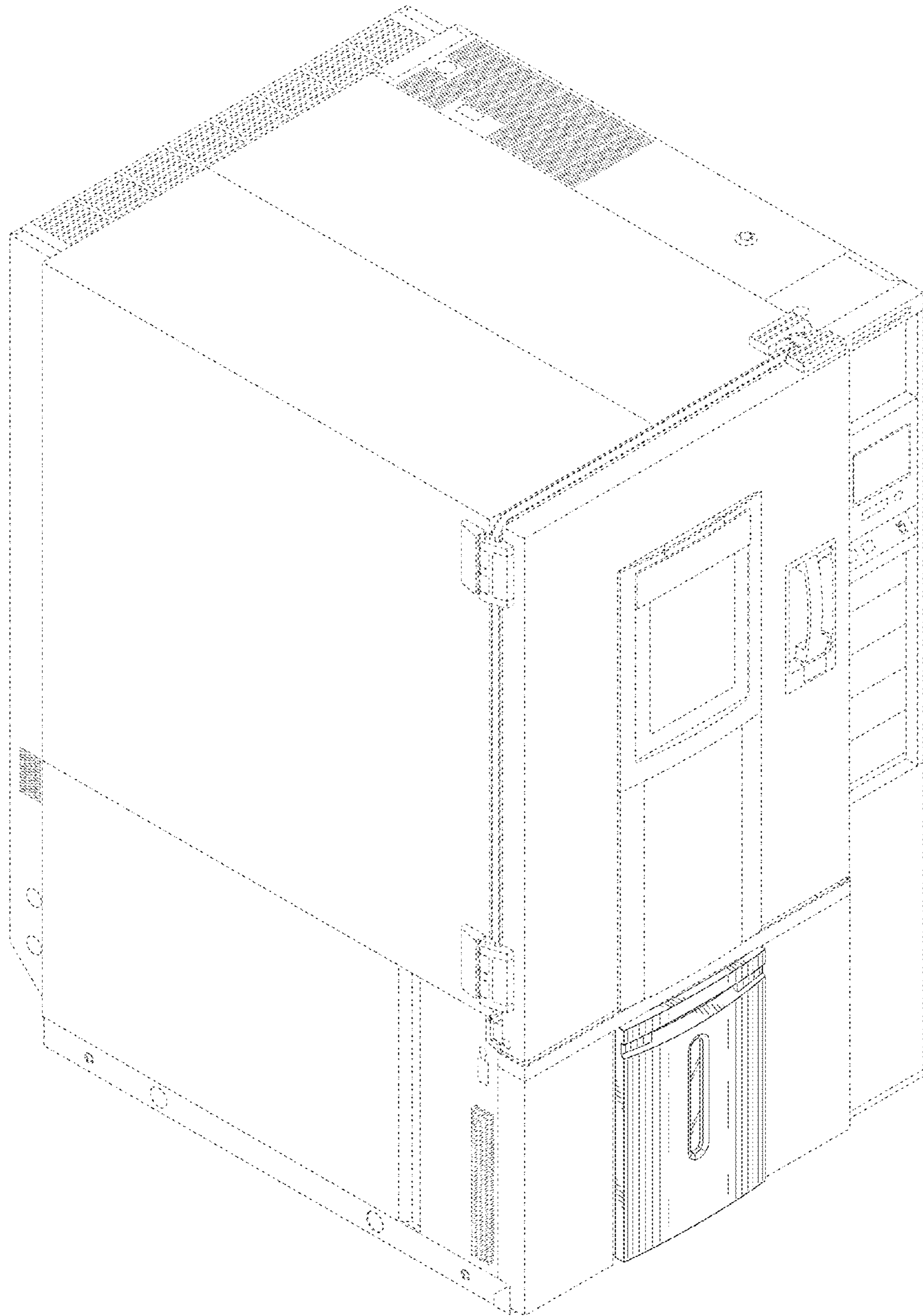

FIG. 1

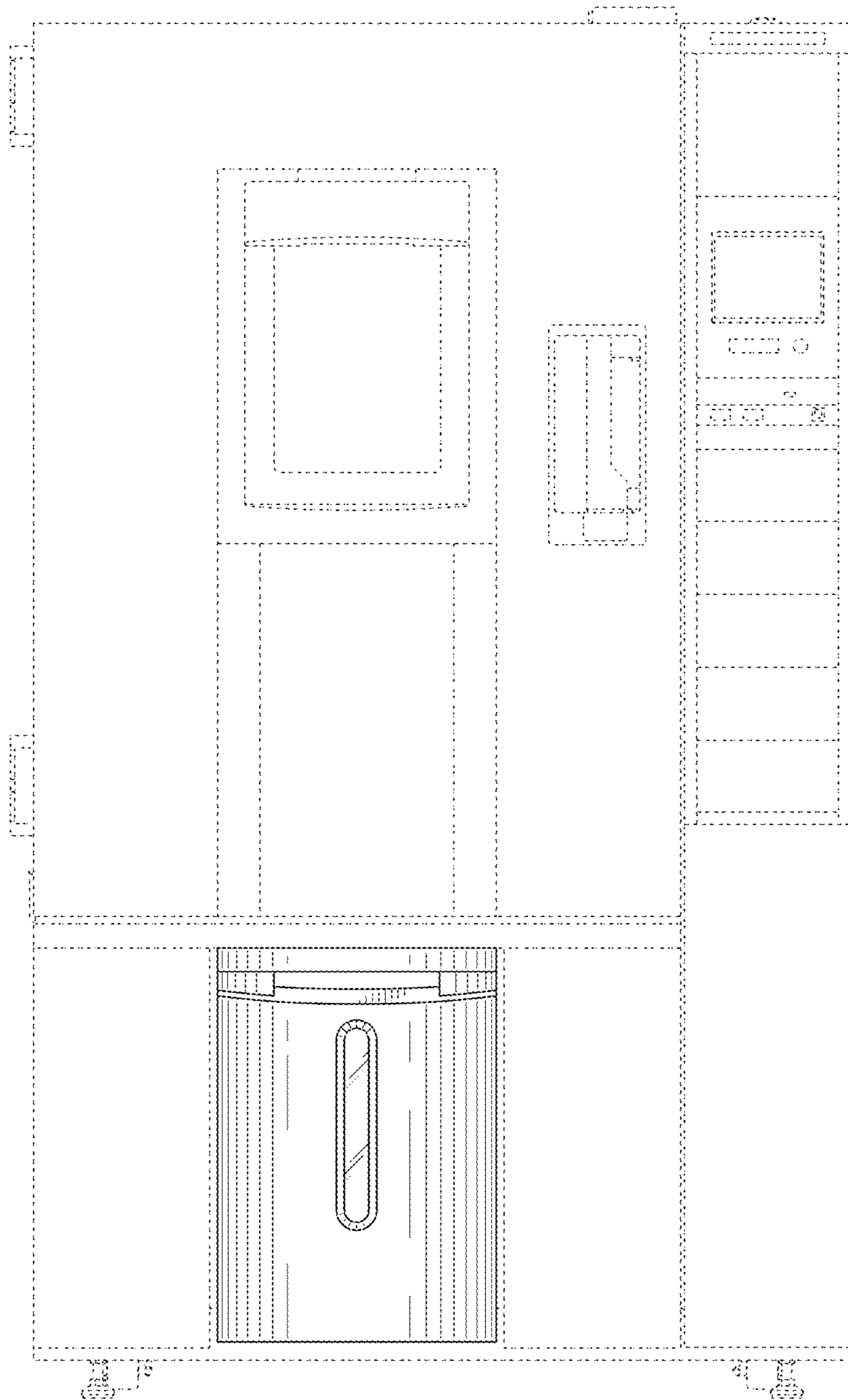

FIG. 2

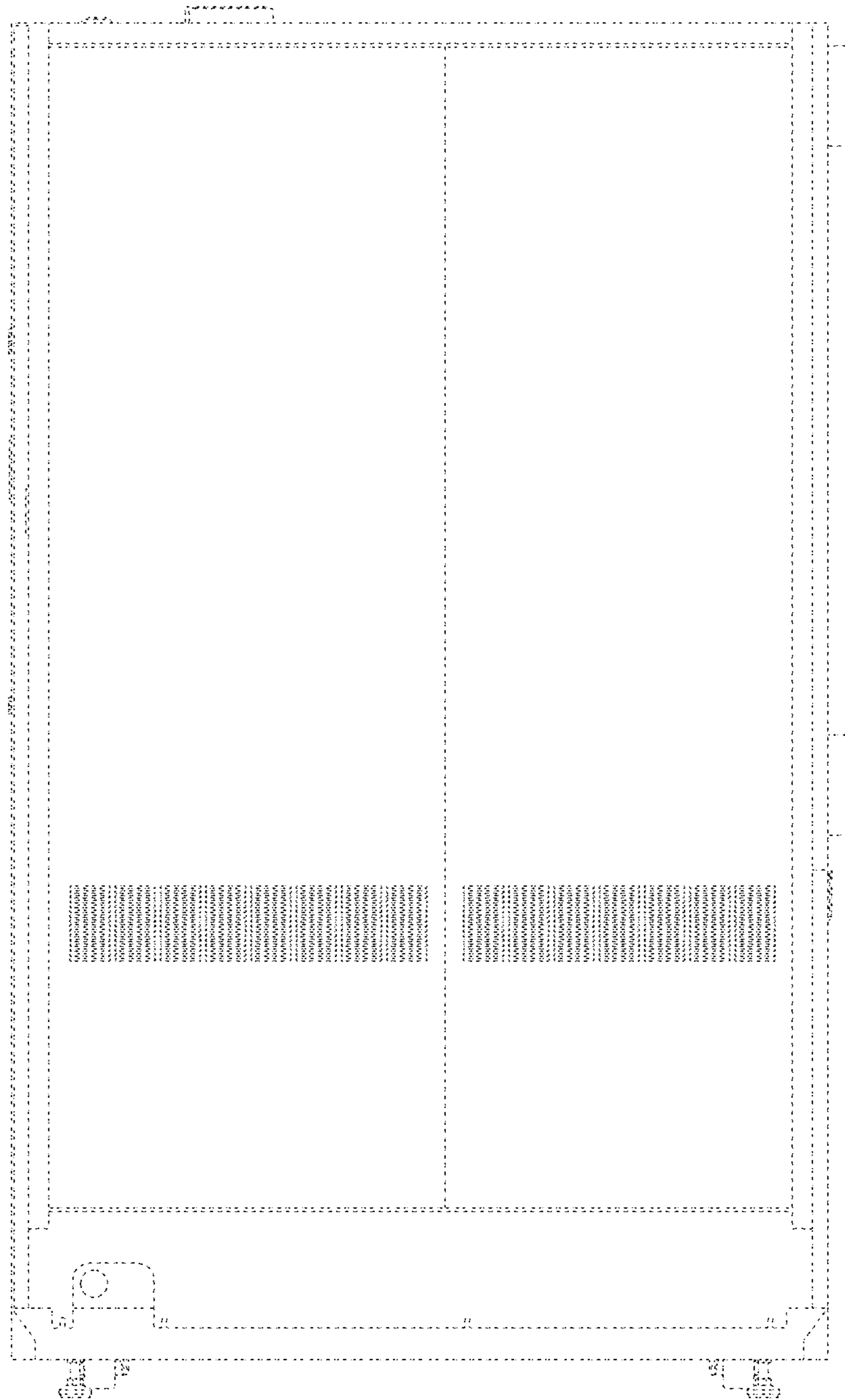

FIG. 3

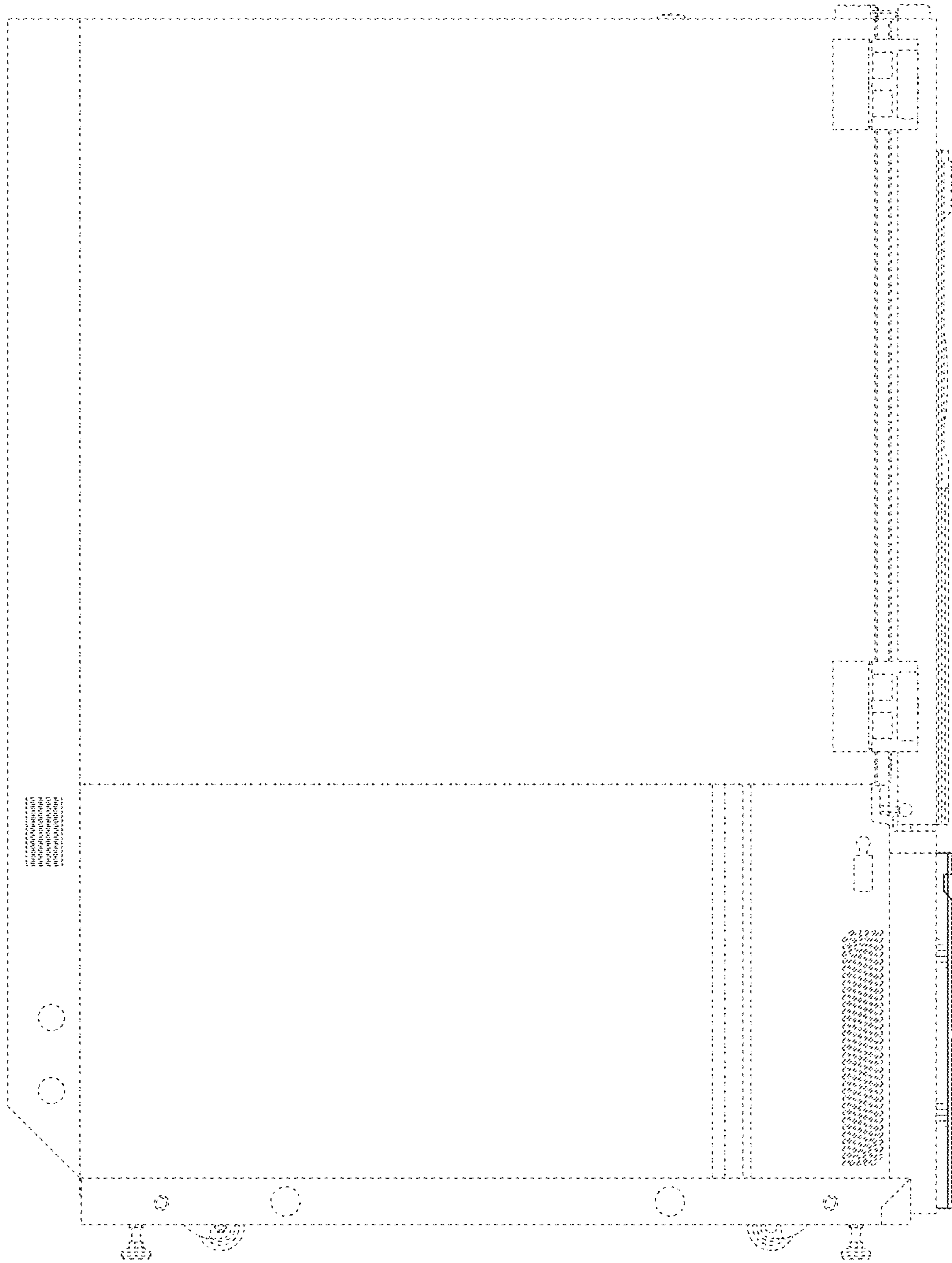

FIG. 4

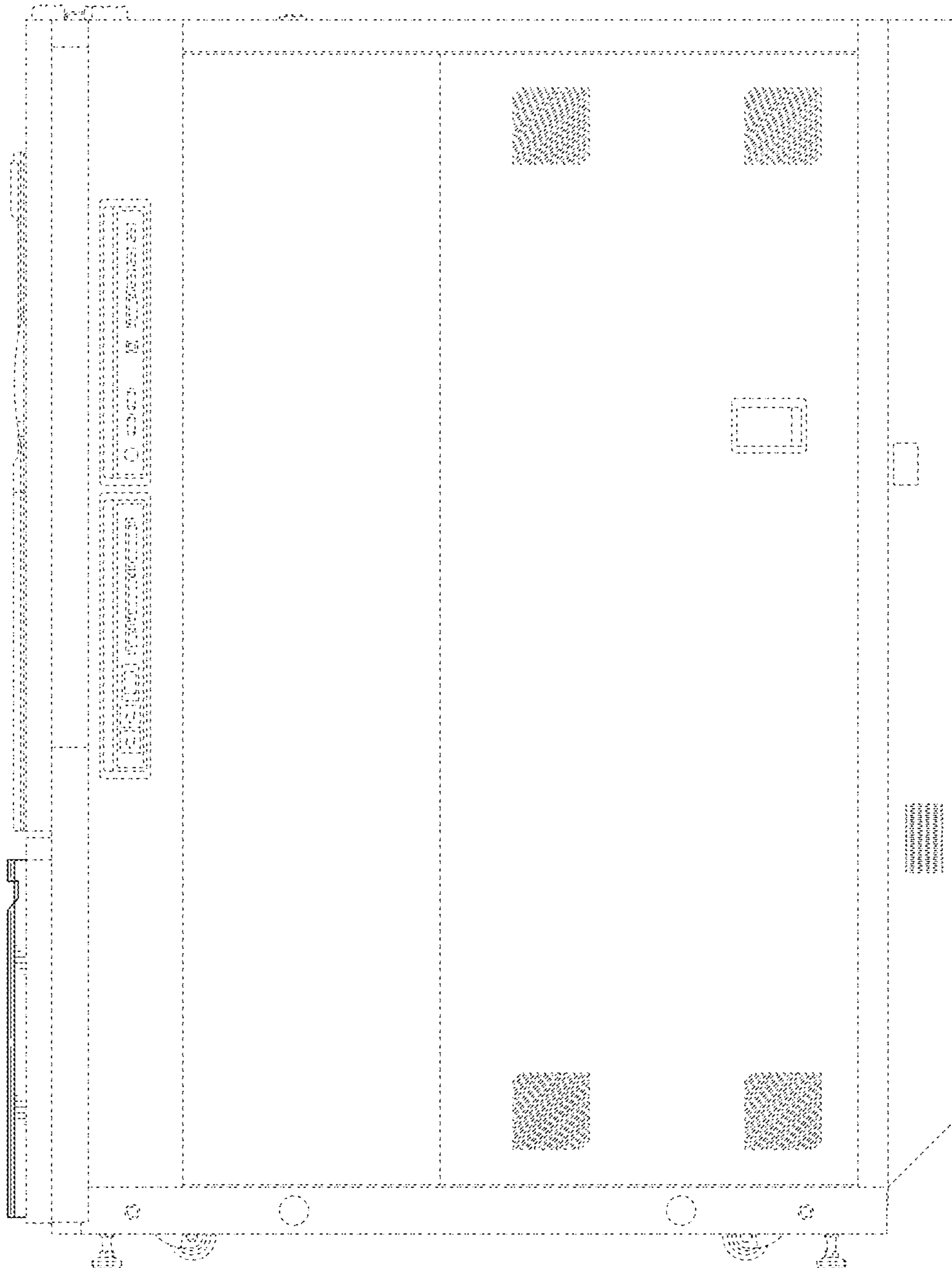

FIG. 5

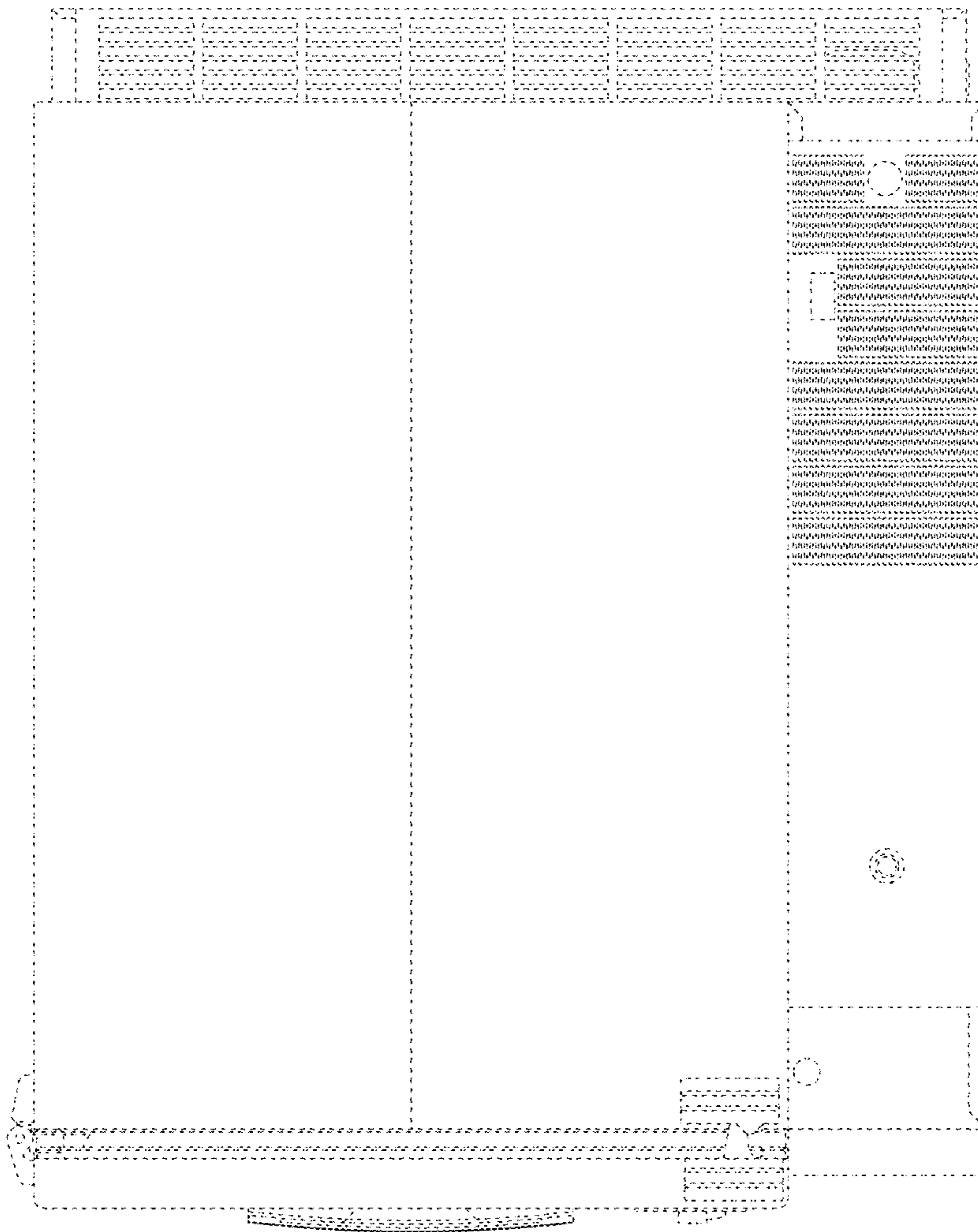

FIG. 6

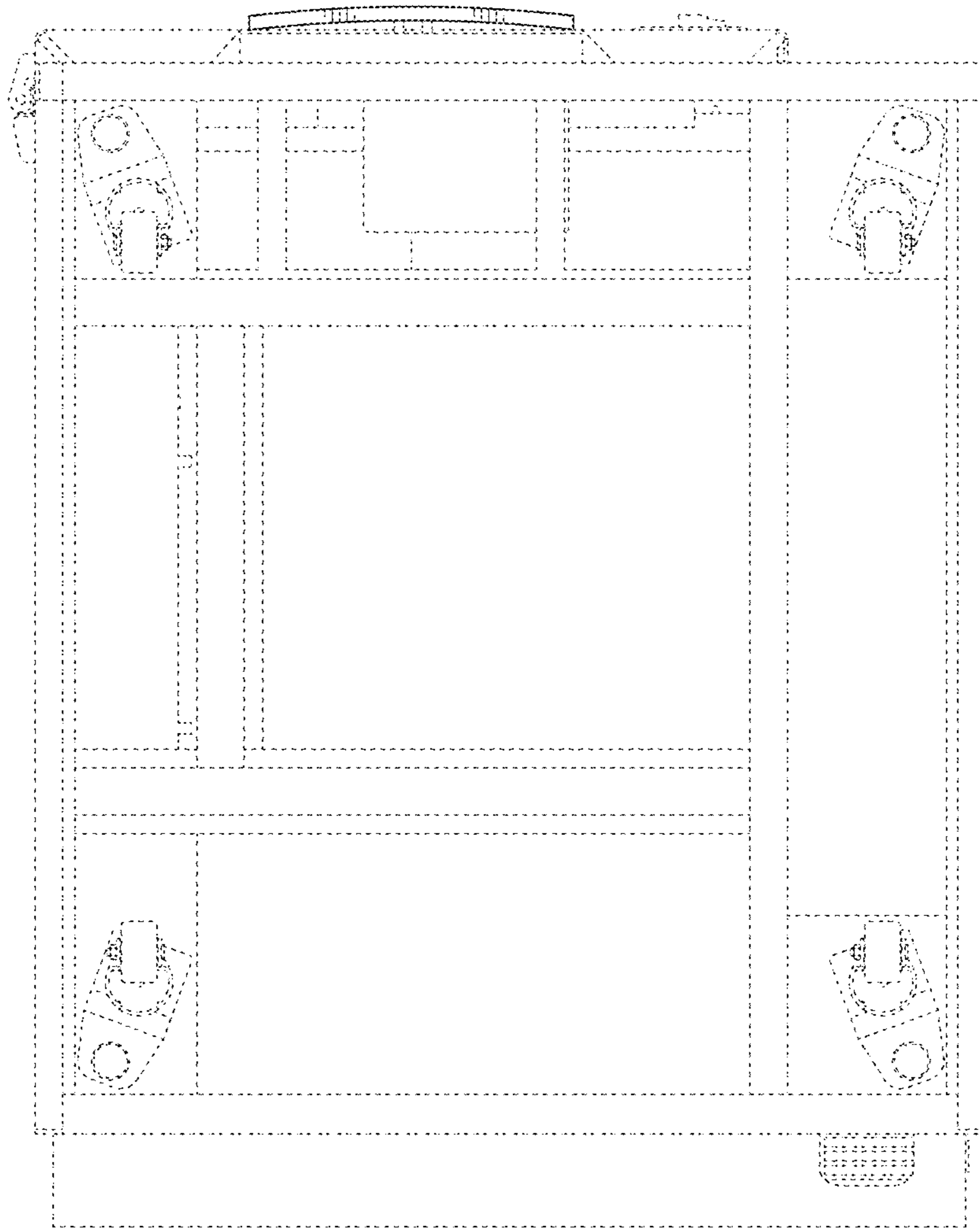

FIG. 7



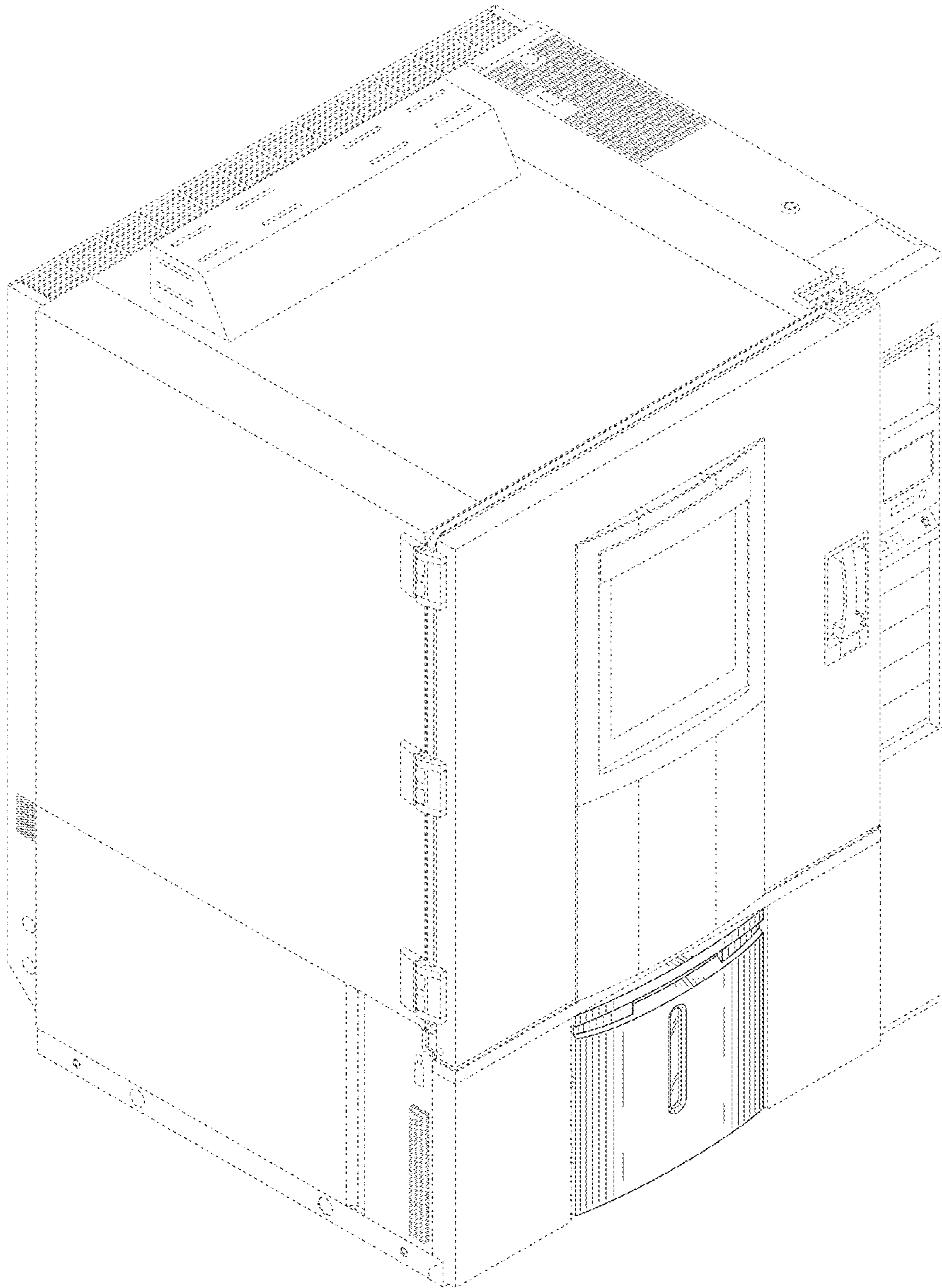

FIG. 8

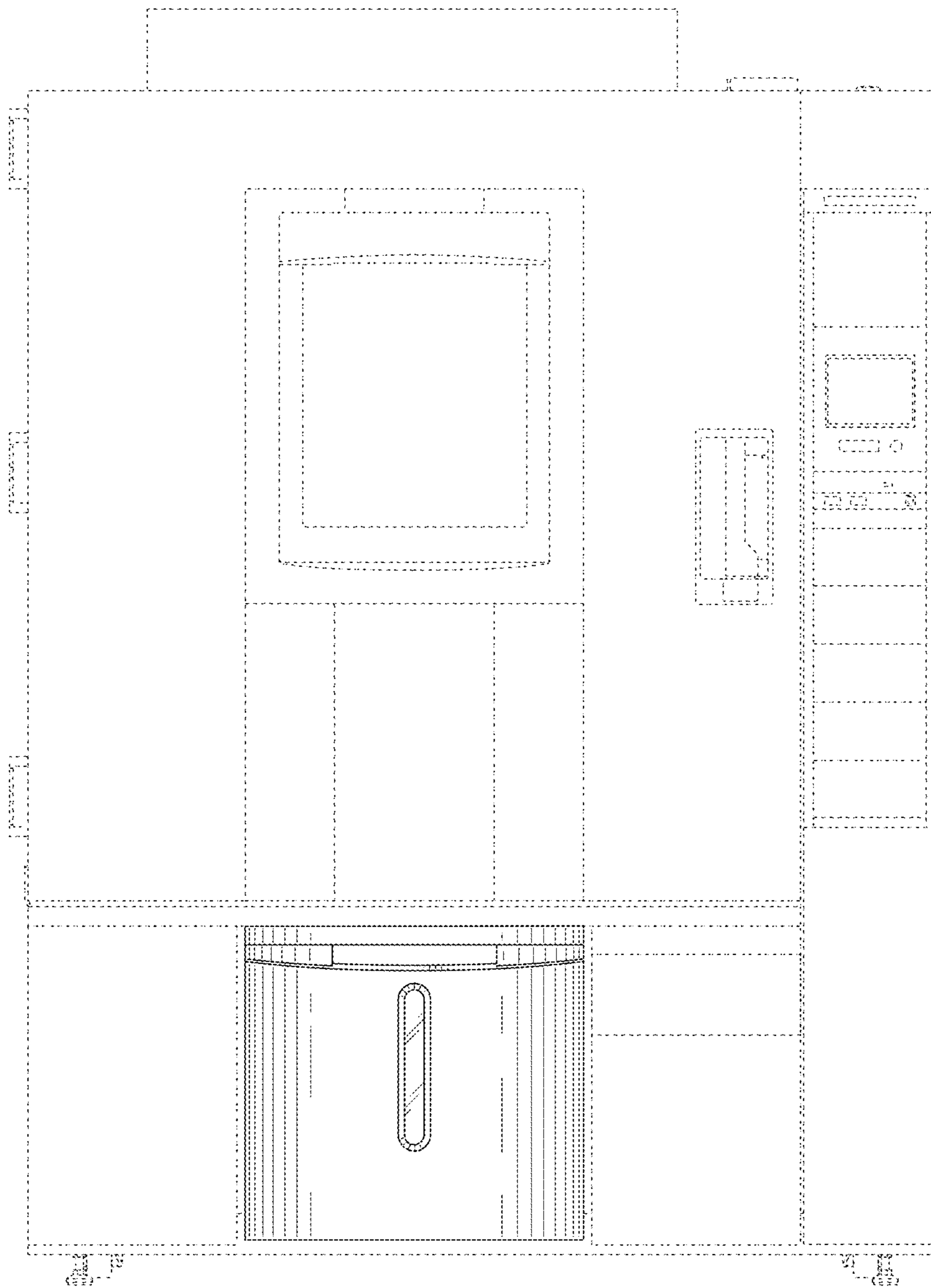

FIG. 9

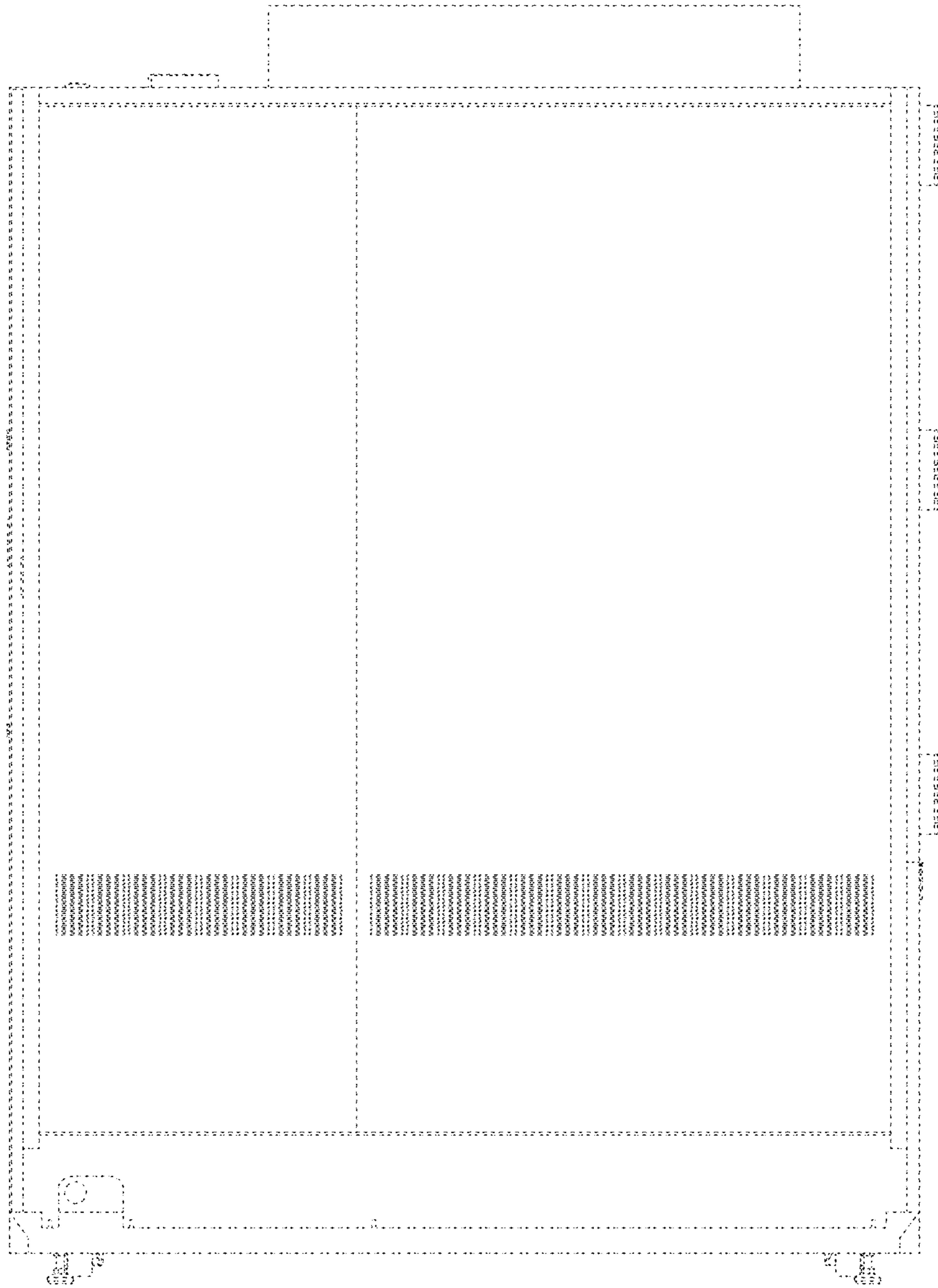

FIG. 10

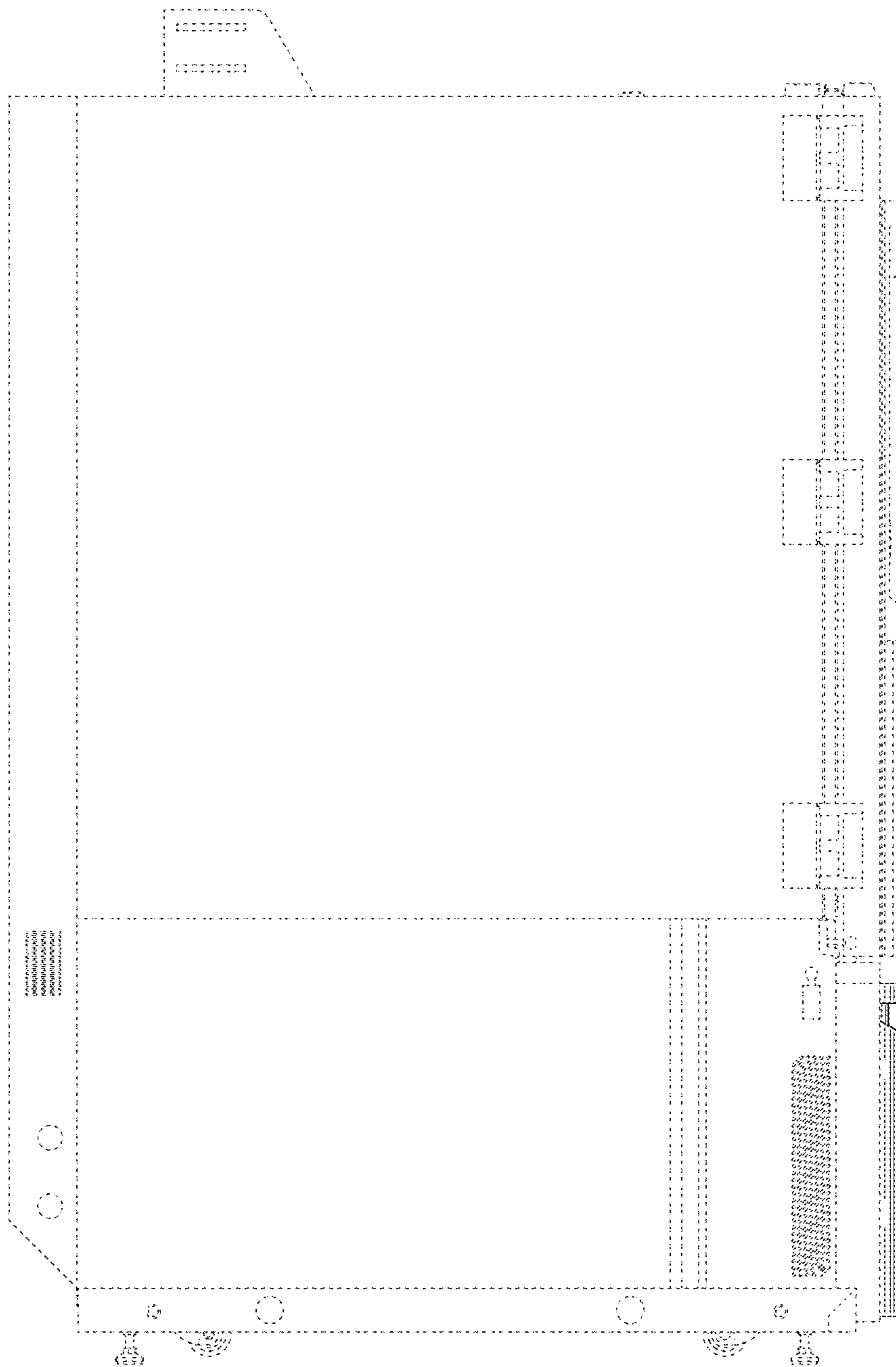
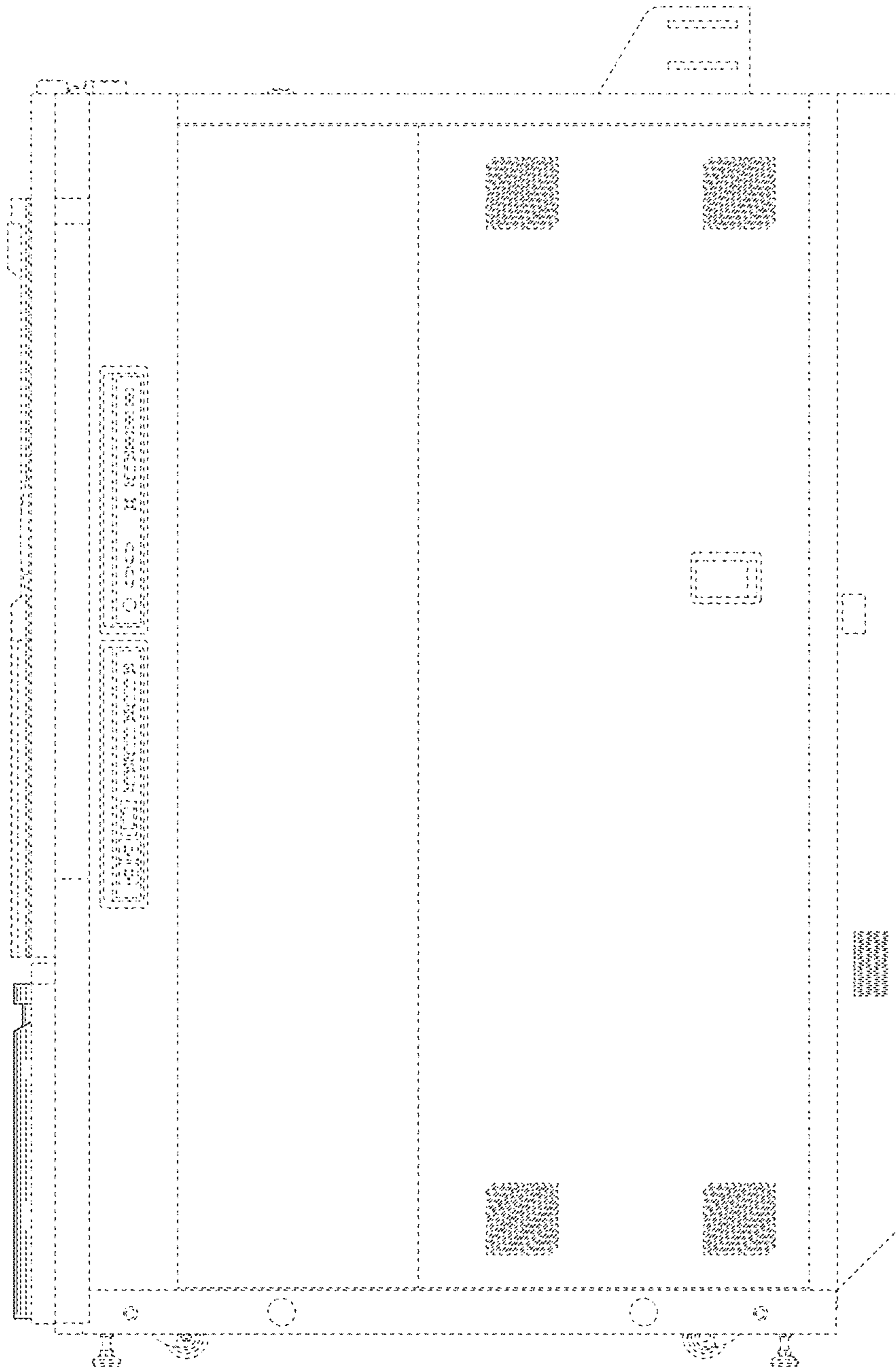

FIG. 11



*FIG. 12*

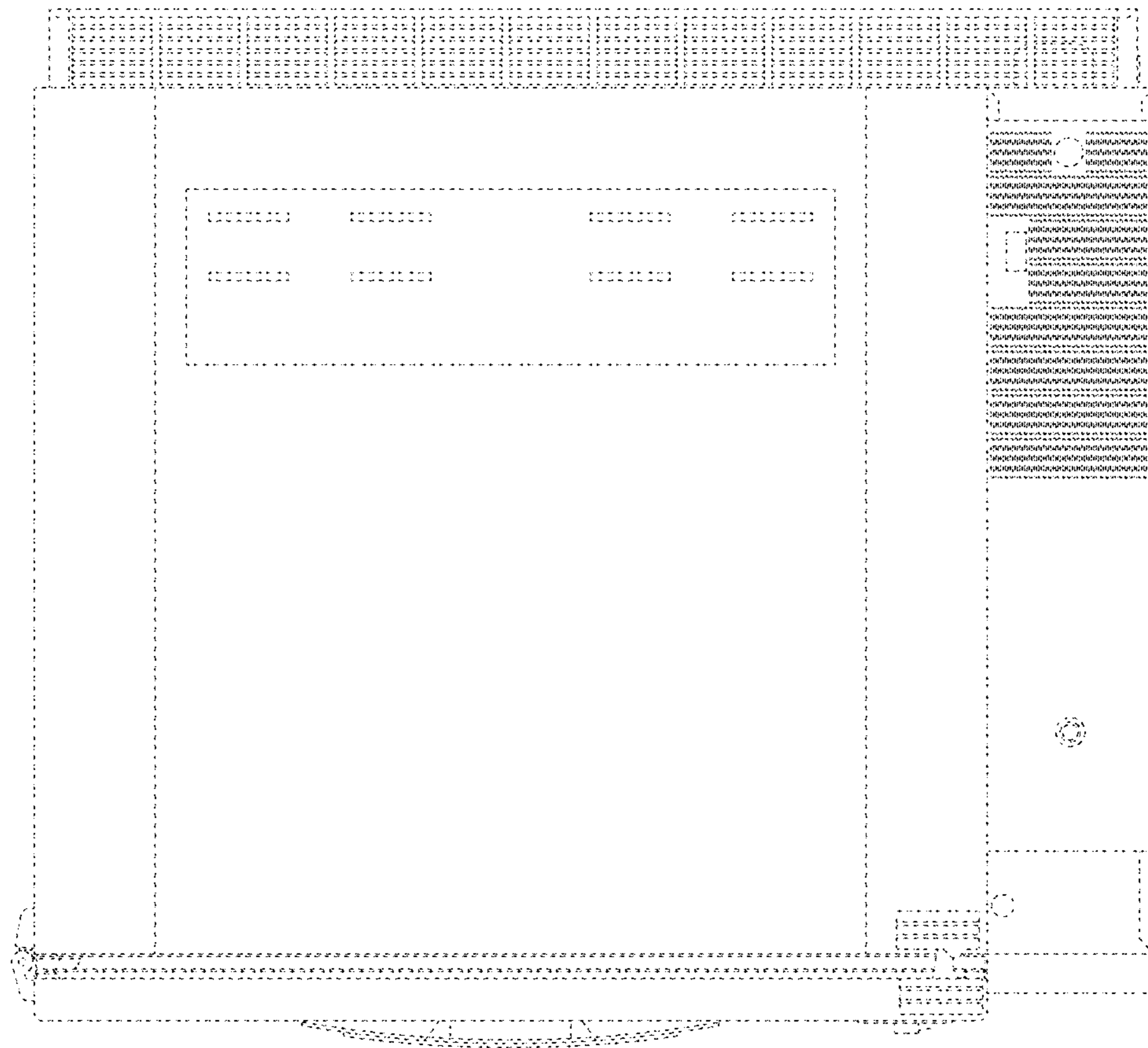
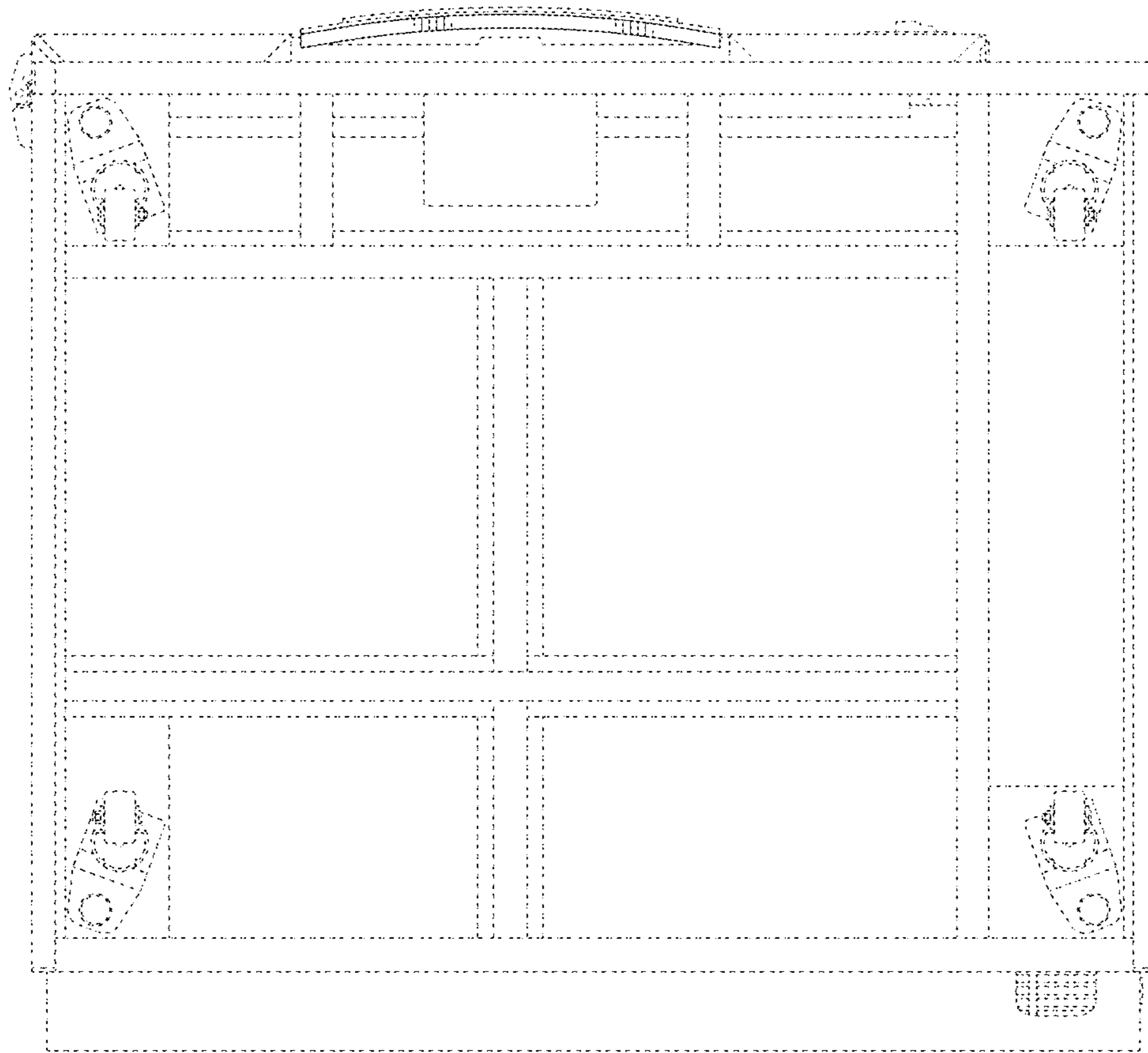

FIG. 13



*FIG. 14*